



User's Guide

OD808 OVERDRIVE

D & S DISTORTION & SUSTAINER

D & S II DISTORTION & SUSTAINER II

PT999 PHASE TONE

GE601 GRAPHIC EQUALIZER

CP101 COMPRESSOR

◆SEFETY PRECAUTIONS◆

Be sure to read these precautions before using this product in order to insure safe operation of the equipment.

Keep this User's Guide on hand for future reference whenever you may need it.

◆安全上のご注意◆

機器を安全にご使用いただくため、ご使用前にこの取扱説明書を必ずお読みください。

そのあとは大切に保管し、必要になったときにお読みください。

SAFETY PRECAUTIONS

Please be sure to observe. The safety precautions listed below are intended to ensure your safety whenever you use the equipment.

■ Precaution text is generally accompanied by the following symbols to alert you and others to the risk of personal and material injury that may be caused if the precaution is ignored.



Warning

This symbol indicates an item that can result in death or serious personal injury if ignored.



Caution

This symbol indicates an item that can result in serious personal injury or material damage if ignored.

■ Precaution text is generally accompanied by the following icons to alert you and others to things you should or should not do.



....A triangle indicates something you should be careful about.



....A circle with a line through it indicates something you should not do.



....A black circle indicates something you must do.



Warning



NEVER OPEN THE CASE

•Never try to remove the bottom cover and to modify the equipment. (Internal components of the equipment use high voltages, and exposing them creates the danger of fire and electrical shock.)



STOP THE USE IN CASE OF A PROBLEM

•Stop using the equipment whenever you notice smoke or a strange odor coming from it.



•Contact your original dealer or nearest authorized service provider for service.



Warning



BEWARE OF HEAT BUILT UP

- Never cover AC adaptor with cloth or other objects.
(Built up heat creates the danger of the equipment deformation and fire.)



Caution



USE SPECIFIED AC ADAPTOR ONLY

- Be sure to use only the AC adaptor specified in this User's Guide. Use of non-specified AC adaptors creates the danger of fire and electrical shock.



UNPLUGGING AC ADAPTOR

- Never try to unplug AC adaptor while your hands are wet. Doing so creates the danger of electrical shock.
- When unplugging AC adaptor from the power source, be sure to grasp the adaptor. Never pull on the cord. Doing so can damage the power cord and create the danger of fire and electrical shock.



WATER, HUMIDITY, DUST AND HIGH TEMPERATURES

- Never leave or use the equipment in bathrooms, the outdoors or other areas subject to water, high humidity, dust and high temperature. Doing so creates the danger of fire and electrical shock.



LEAVING THE EQUIPMENT UNATTENDED

- Whenever leaving the equipment unattended for long periods, be sure to unplug AC adaptor from the power source. If not, there is a danger of fire.

OD808 OVERDRIVE

- OD808 produces natural and mild overdrive effects suggestive of vacuum tube amplifier while retaining your guitar's original tone.
- As a booster, it gives you pleasant gain without spoiling amplifier's original character.

FEATURES AND CONTROLS

① OVERDRIVE (Overdrive Control)

Controls distortion and sustain level. Rotate this volume clockwise for more distortion and sustain.

② TONE (Tone Control)

Controls effect tone. Rotate this volume clockwise to emphasize middle and high tone.

③ BALANCE (Balance Control)

Controls output level of effected tone. Typically output levels of both normal tone and effected tone should be adjusted to equal levels.

④ NORMAL / EFFECT

(Normal / Effect Switch)

Switch for effect on/off. Stepping on this switch alternately turns effects on (LED on) and off (LED off).

⑤ INDICATOR (LED Indicator)

It lights on when effects are on and lights off when effects are off. It also indicates battery condition. Dark or no LED light indicates the battery is low or not installed. Replace the battery.

⑥ INSTRUMENT (Instrument Jack)

Input jack to connect to the output of guitar, other effects or related equipment. The product automatically turns on when you put a plug when not in use.

⑦ AMPLIFIER (Amplifier Jack)

Output jack to connect to the input of amplifier or other effects.

⑧ DC IN (Power Input Jack)

A jack to connect AC adaptor.

- Easy-to-see LED enables you to check the effects ON/OFF and battery condition at a glance.
- Two types of power supply - 9V battery or special AC adaptor.

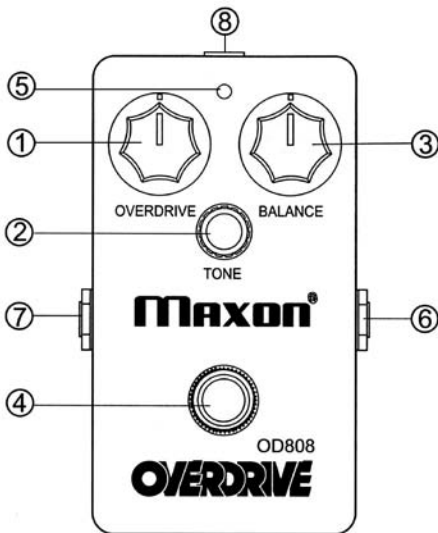

SAMPLE SETTING

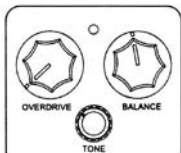

OD808 No.1

Setting for boost. It gives energy to your sound, making the most of guitar and amplifier's original tone. Works with amplifier's clean and drive setting.

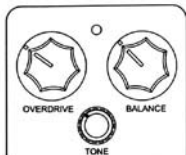

OD808 No.4 (for single-coil pickup)

Setting for adding overdrive to amplifier's crunch for more sustain and power.

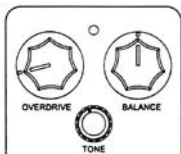

OD808 No.2

Setting for the tone exclusive to OD808. It boosts up level and sustain for solos, with your guitar and amplifier's original character unchanged.

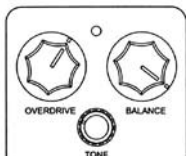

OD808 No.5 (for humbucking pickup)

Setting to add overdrive effects to amplifier's drive for high gain drive with long sustain. Create overdrive by controlling amplifier's gain and OD808's OVERDRIVE.

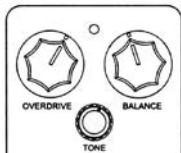

OD808 No.3

Smooth drive tone that is characteristic of OD808. Recommended setting for those who want their guitar's tonal character and picking attack unchanged.

CONNECTION DIAGRAM

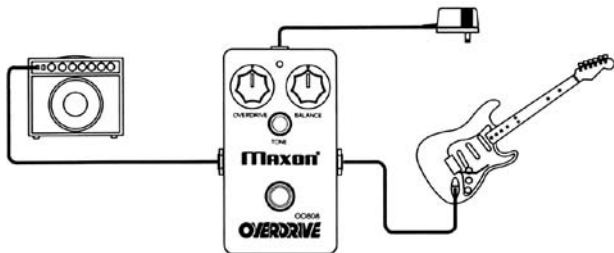

OD808 (OVERDRIVE)

SPECIFICATIONS

Input Impedance	: 500k ohms
Input Jack	: 1/4-inch standard phone jack
Output Impedance	: 10k ohms
Output Jack	: 1/4-inch standard phone jack
Control	: OVERDRIVE, BALANCE, TONE
Switch	: normal / effect
Equivalent Input Noise	: -110dBu (IHF-A)
Maximum Gain	: 35dB
Power Supply	: One 9V battery or Maxon AC adaptor (option)
Power Requirements	: DC9-10V
Current Consumption	: 5mA (9V) / 6mA (10V)
Dimensions (main body)	: 61mm(W) x 112mm(D) x 35mm(H)
Dimensions (overall)	: 70mm(W) x 112mm(D) x 35mm(H)
Weight	: 9V battery (6LR61 or 6F22) x 1 or Maxon AC adaptor
Standard Accessories	: 260g : 9V manganese dry battery x 1, skid x 1

* Specifications are subject to change without notice.

※(0dBu=0.775Vms)

D&S DISTORTION & SUSTAINER

- Amazingly long sustain and hot distortion without spoiling your guitar's original tone.
- D&S produces a wide variety of distortion from heavy and thick distortion suggestive of vacuum tube amplifier to extreme vintage fuzz.

FEATURES AND CONTROLS

① DISTORTION (Distortion Control)

Controls distortion and sustain level. Rotate this volume clockwise for more distortion and sustain.

② TONE (Tone Control)

Controls effect tone. Rotate this volume clockwise to emphasize middle and high tone range.

③ BALANCE (Balance Control)

Controls output level of effected tone. Typically output levels of both normal tone and effected tone should be adjusted to equal levels.

④ NORMAL / EFFECT

(Normal / Effect Switch)

Switch for effect on/off. Stepping on this switch alternately turns effects on (LED on) and off (LED off).

⑤ INDICATOR (LED Indicator)

It lights on when effects are on and lights off when effects are off. It also indicates battery condition. Dark or no LED light indicates the battery is low or not installed. Replace the battery.

⑥ INSTRUMENT (Instrument Jack)

Input jack to connect to the output of guitar, other effects or related equipment. The product automatically turns on when you put a plug into this jack. Pull out the plug when not in use.

⑦ AMPLIFIER (Amplifier Jack)

Output jack to connect to the input of amplifier or other effects.

⑧ DC IN (Power Input Jack)

A jack to connect AC adaptor.

- Easy-to-see LED enables you to check the effects ON/OFF and battery condition at a glance.
- Two types of power supply - 9V battery or special AC adaptor.

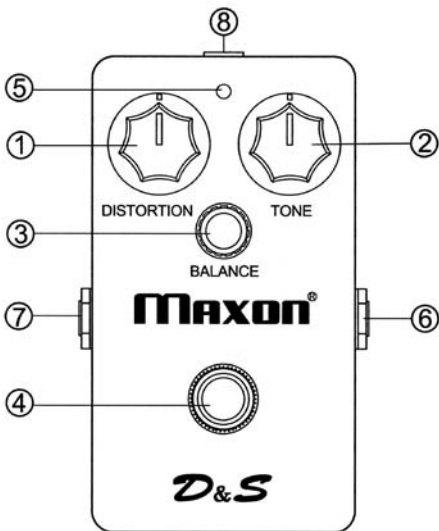

SAMPLE SETTING

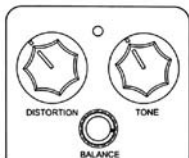

D&S No.1 (for humbucking pickup)
Characteristic tone of D&S, with power and sharpness of original D&S.

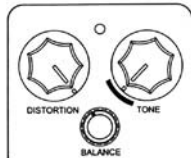

D&S No.4 (for single-coil pickup)
Fuzz-type distortion with low TONE for soft and powerful single-coil pickup timbre.
(amplifier / clean setting)

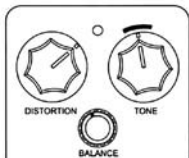

D&S No.2 (for single-coil pickup)
High gain drive of stack amplifier reproduced by single-coil pickup and powerful D&S. Enjoy switching between this setting and amplifier's clean setting.

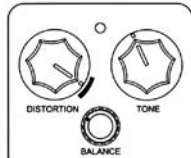

D&S No.5 (for humbucking pickup)
Deep distortion for powerful and heavy sound. It's for both rhythm and lead guitar.

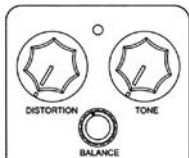

D&S No.3
Setting to combine D&S and amplifier's drive for sinewy solo. This is characteristic of D&S, which provides enough tone quality even with DISTORTION level set to zero.

CONNECTION DIAGRAM

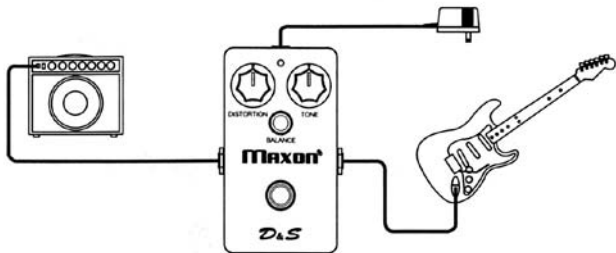

D & S (DISTORTION & SUSTAINER)

SPECIFICATIONS

Input Impedance	: 500k ohms
Input Jack	: 1/4-inch standard phone jack
Output Impedance	: 10k ohms
Output Jack	: 1/4-inch standard phone jack
Control	: DISTORTION, TONE, BALANCE
Switch	: normal / effect
Equivalent Input Noise	: -110dBu (IHF-A)
Maximum Gain	: 40dB
Power Supply	: One 9V battery or Maxon AC adaptor (option)
Power Requirements	: DC9-10V
Current Consumption	: 6mA (9V) / 7mA (10V)
Dimensions (main body)	: 61mm(W) x 112mm(D) x 35mm(H)
Dimensions (overall)	: 70mm(W) x 112mm(D) x 35mm(H)
Weight	: 9V battery (6LR61 or 6F22) x 1 or Maxon AC adaptor
Standard Accessories	: 260g : 9V manganese dry battery x 1, skid x 1

* Specifications are subject to change without notice.

※(0dBu=0.775Vms)

D&S II DISTORTION & SUSTAINER II

- Soft type distortion for thick, heavy tone and relaxed natural sustain.
- D&S II produces a wide range of distortion sounds, from warm tone characteristic of tube amplifier overdrive to aggressive distortion.

FEATURES AND CONTROLS

- ① **DISTORTION (Distortion Control)**
Controls distortion and sustain level. Rotate this volume clockwise for more distortion and sustain.
- ② **TONE (Tone Control)**
Controls effect tone. Rotate this volume clockwise to emphasize middle and high tone range.
- ③ **BALANCE (Balance Control)**
Controls output level of effected tone. Typically output levels of both normal tone and effected tone should be adjusted to equal levels.
- ④ **FOOT SWITCH (Normal / Effect Switch)**
Switch for effect on/off. Stepping on this switch alternately turns effect on (LED on) and off (LED off).
- ⑤ **INDICATOR (LED Indicator)**
It lights on when effects are on and lights off when effects are off. It also indicates battery condition. Dark or no LED light indicates the battery is low or not installed. Replace the battery.
- ⑥ **INSTRUMENT (Instrument Jack)**
Input jack to connect to the output of guitar, other effects or related equipment. The product automatically turns on when you put a plug into this jack. Pull out the plug when not in use.
- ⑦ **AMPLIFIER (Amplifier Jack)**
Output jack to connect to the input of amplifier or other effects.
- ⑧ **DC IN (Power Input Jack)**
A jack to connect AC adaptor.

- Easy-to-see LED enables you to check the effects ON/OFF and battery condition at a glance.
- Two types of power supply - 9V battery or special AC adaptor.

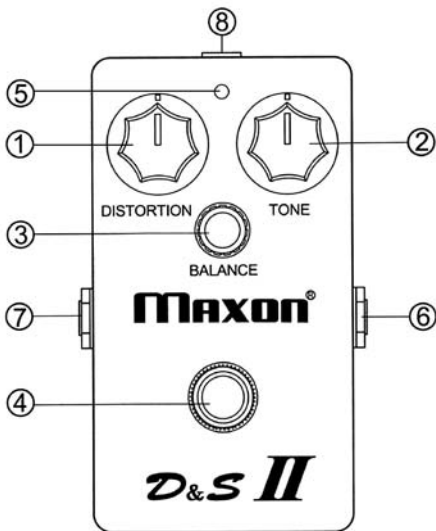

SAMPLE SETTING

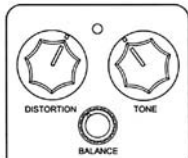

D&S II No.1 (for single-coil pickup)
Setting for solid boost sound with your amplifier's original character preserved.

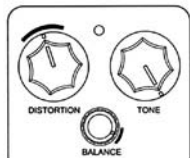

D&S II No.4
High gain type distortion to boost amplifier's drive. Adjust the balance between amplifier's gain volume and D&S II's DISTORTION.

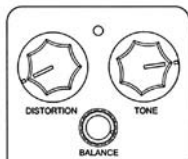

D&S II No.2 (for humbucking pickup)
Setting for solid boost sound with your amplifier's original character preserved.

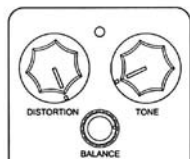

D&S II No.5
Fat and heavy distortion particular to D&S II. TONE can be adjusted for fuzz-like sound.

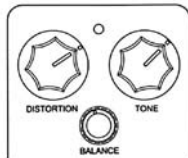

D&S II No.3
Easy-to-control setting to simulate tube amplifier distortion.

CONNECTION DIAGRAM

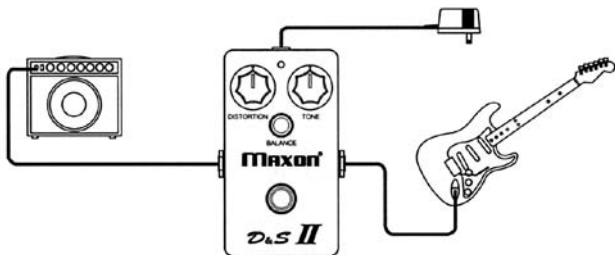

D & S II (DISTORTION & SUSTAINER II)

SPECIFICATIONS

Input Impedance	: 500k ohms
Input Jack	: 1/4-inch standard phone jack
Output Impedance	: 10k ohms
Output Jack	: 1/4-inch standard phone jack
Control	: DISTORTION, TONE, BALANCE
Switch	: normal / effect
Equivalent Input Noise	: -110dBu (IHF-A)
Maximum Gain	: 40dB
Power Supply	: One 9V battery or Maxon AC adaptor (option)
Power Requirements	: DC9-10V
Current Consumption	: 7mA (9V) / 8mA (10V)
Dimensions (main body)	: 61mm(W) x 112mm(D) x 35mm(H)
Dimensions (overall)	: 70mm(W) x 112mm(D) x 35mm(H)
Weight	: 9V battery (6LR61 or 6F22) x 1 or Maxon AC adaptor
Standard Accessories	: 290g : 9V manganese dry battery x 1, skid x 1

* Specifications are subject to change without notice.

※(0dBu=0.775Vms)

PT999 PHASE TONE

- Low-noise design with wide dynamic range for live and recording. It's for all kinds of electric instruments like guitar, bass and keyboard.
- You can produce various sounds with only one control volume (speed) - from clear and mild phase tone that gives your sound a subtle flavor to radically rolling

FEATURES AND CONTROLS

① SPEED (Speed Control)

Controls modulation rate. Rotate this volume clockwise to increase modulation rate.

② NORMAL / PHASE SHIFT

(Normal / Effect Switch)

Switch for effect on/off. Stepping on this switch alternately turns effects on (LED on) and off (LED off).

③ INDICATOR (LED Indicator)

It lights on when effects are on and lights off when effects are off. It also indicates battery condition. Dark or no LED light indicates the battery is low or not installed. Replace the battery.

④ INSTRUMENT (Instrument Jack)

Input jack to connect to the output of guitar, other effects or related equipment. The product automatically turns on when you put a plug into this jack. Pull out the plug when not in use.

⑦ AMPLIFIER (Amplifier Jack)

Output jack to connect to the input of amplifier or other effects.

⑧ DC IN (Power Input Jack)

A jack to connect AC adaptor.

phase sound.

- Easy-to-see LED enables you to check the effects ON/OFF and battery condition at a glance.
- Two types of power supply - 9V battery or special AC adaptor.

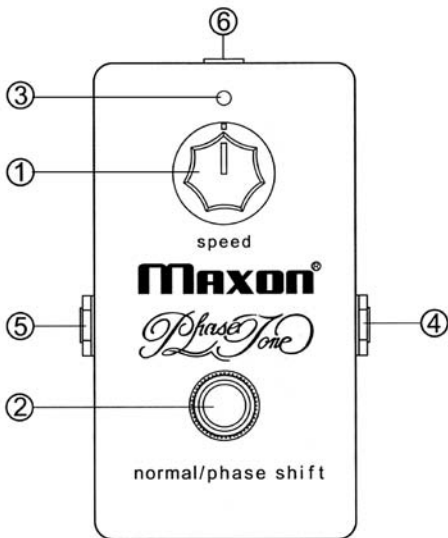

SAMPLE SETTING

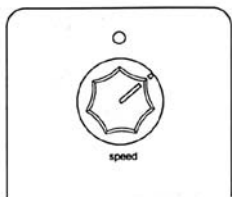

PT999 No.1
Blues phasing to add to overdriven sound.

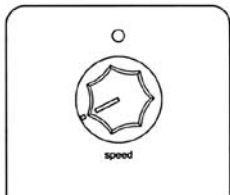

PT999 No.3
Subtle phasing timbre to make your solo thick and smooth in distortion sound.

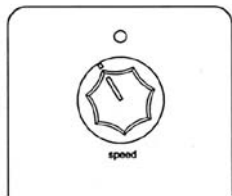

PT999 No.2
Best phasing sound for sixteen beat rhythm play.

CONNECTION DIAGRAM

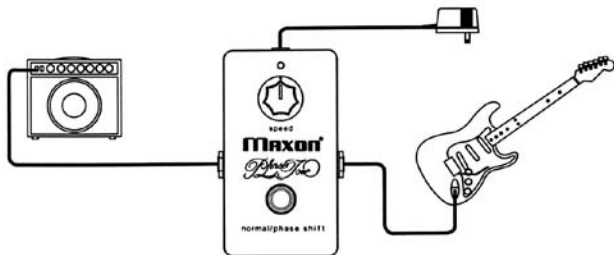

PT999 (PHASE TONE)

SPECIFICATIONS

Input Impedance	: 500k ohms
Input Jack	: 1/4-inch standard phone jack
Output Impedance	: 10k ohms
Output Jack	: 1/4-inch standard phone jack
Control	: SPEED
Switch	: normal / effect
Maximum Input Level	: 0dBu
Equivalent Input Noise	: -80dBu (IHF-A)
Speed Range	: 0.2Hz - 14Hz
Power Supply	: One 9V battery or Maxon AC adaptor (option)
Power Requirements	: DC9-10V
Current Consumption	: 12mA (9V) / 14mA (10V)
Dimensions (main body)	: 61mm(W) x 112mm(D) x 35mm(H)
Dimensions (overall)	: 70mm(W) x 112mm(D) x 35mm(H)
Weight	: 9V battery (6LR61 or 6F22) x 1 or Maxon AC adaptor
Standard Accessories	: 270g
	: 9V manganese dry battery x 1, skid x 1

* Specifications are subject to change without notice.

※(0dBu=0.775Vms)

GE601 GRAPHIC EQUALIZER

- Six-band graphic equalizer and an overall level volume to produce various sounds at will.
- Six band ranges covering 100Hz to 3.2KHz for easy tone making to your taste. It also works as a point booster for special effects.

FEATURES AND CONTROLS

- ① Adjust each slide volume (100Hz, 200Hz, 400Hz, 800Hz, 1.6KHz, 3.2KHz) to your taste. Slide it up for +12dB level boost and down for -12dB level cut.
 - ② LEVEL (Level Control)
Controls output level of effected tone. Slide it up for +12dB level boost and down for -12dB level cut.
 - ③ NORMAL / EFFECT
(Normal / Effect Switch)
Switch for effect on/off. Stepping on this switch alternately turns effects on (LED on) and off (LED off).
 - ④ INDICATOR (LED Indicator)
It lights on when effects are on and lights off when effects are off. It also indicates battery condition. Dark or no LED light indicates the
- is low or not installed. Replace the battery.
- ⑤ INSTRUMENT (Instrument Jack)
Input jack to connect to the output of guitar, other effects or related equipment. The product automatically turns on when you put a plug into this jack. Pull out the plug when not in use.
 - ⑥ AMPLIFIER (Amplifier Jack)
Output jack to connect to the input of amplifier or other effects.
 - ⑦ DC IN (Power Input Jack)
A jack to connect AC adaptor.

- Easy-to-see LED enables you to check the effects ON/OFF and battery condition at a glance.
- Two types of power supply - 9V battery or special AC adaptor.

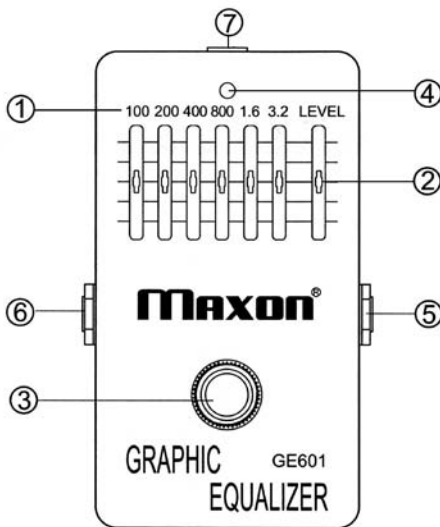

SAMPLE SETTING

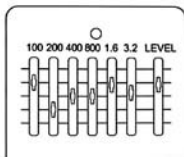

GE601 No.1 (for humbucking pickup)
Setting for passive pickup bass to simulate active pickup bass with GE601 as pre-amp. It produces clear tone peculiar to active-type bass.

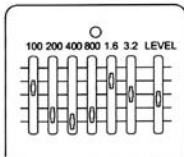

GE601 No.4 (for humbucking pickup)
Setting to cut off the middle range of humbucking pickup to simulate sharp sound of single-coil pickup.

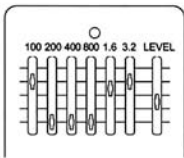

GE601 No.2
Setting to change single-coil pickup tone to electric acoustic guitar sound. Cutting off the middle and low ranges, it stresses the brightness of guitar with piezo pickups.

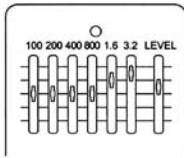

GE601 No.5
Setting to add edge to overdriven tone of humbucking pickup.
Indistinct distorted tone in solos will be cleared.

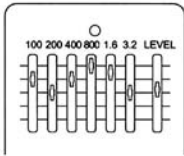

GE601 No.3
Equalizing to add power to single-coil pickup tone. It boosts up the middle range for solo.

CONNECTION DIAGRAM

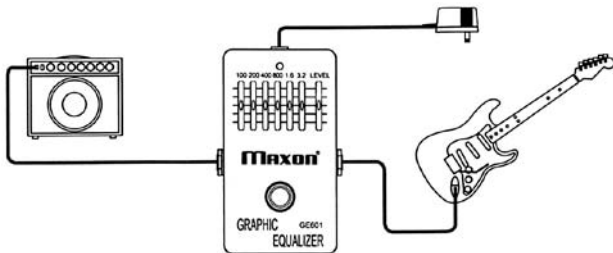

GE601 (GRAPHIC EQUALIZER)

SPECIFICATIONS

Input Impedance	: 500k ohms
Input Jack	: 1/4-inch standard phone jack
Output Impedance	: 10k ohms
Output Jack	: 1/4-inch standard phone jack
Control	: 100Hz, 200Hz, 400Hz, 800Hz, 1.6KHz, 3.2KHz, LEVEL
Switch	: normal / effect
Maximum Input Level	: 4dBu
Equivalent Input Noise	: -100dBu (IHF-A)
Power Supply	: One 9V battery or Maxon AC adaptor (option)
Power Requirements	: DC9-10V
Current Consumption	: 11mA (9V) / 12mA (10V)
Dimensions (main body)	: 61mm(W) x 112mm(D) x 35mm(H)
Dimensions (overall)	: 70mm(W) x 112mm(D) x 35mm(H)
Weight	: 9V battery (6LR61 or 6F22) x 1 or Maxon AC adaptor
Standard Accessories	: 240g
	: 9V manganese dry battery x 1, skid x 1

* Specifications are subject to change without notice.

※(0dBu=0.775Vms)

CP101 COMPRESSOR

- Clean and natural compression effects with little change of original tone.
- Limiter-like effects for evenly leveled rhythm cutting sound. Tasteful pick attack and relaxed sustain for lead guitar. It's great for bass guitar and semi-acoustic guitar as well.

FEATURES AND CONTROLS

① SUSTAIN (Sustain Control)

Controls sustain time of each pick attack. Rotate this volume clockwise for deep compression and long sustain.

② LEVEL (Level Control)

Controls output level of effected tone. Typically output levels of both normal tone and effected tone should be adjusted to equal levels.

③ NORMAL / EFFECT

(Normal / Effect Switch)

Switch for effect on/off. Stepping on this switch alternately turns effects on (LED on) and off (LED off).

④ INDICATOR (LED Indicator)

It lights on when effects are on and lights off when effects are off. It also indicates battery condition. Dark or no LED light indicates the battery is low or not installed. Replace the battery.

⑤ INSTRUMENT (Instrument Jack)

Input jack to connect to the output of guitar, other effects or related equipment. The product automatically turns on when you put a plug into this jack. Pull out the plug when not in use.

⑥ AMPLIFIER (Amplifier Jack)

Output jack to connect to the input of amplifier or other effects.

⑦ DC IN (Power Input Jack)

A jack to connect AC adaptor.

- Easy-to-see LED enables you to check the effects ON/OFF and battery condition at a glance.
- Two types of power supply - 9V battery or special AC adaptor.

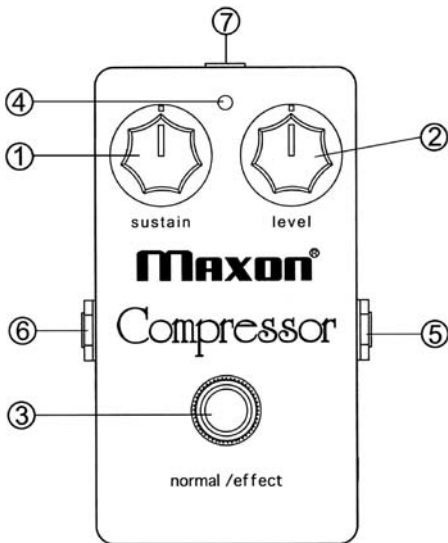

SAMPLE SETTING

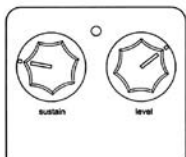

CP101 No.1
Setting for bass guitar and also for MTR. Attack tone in slapping can be adjusted by SUSTAIN volume.

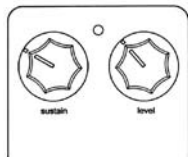

CP101 No.4
Setting for balanced attack of chord stroke both in drive and clean sound.

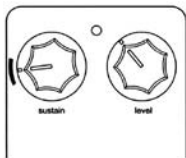

CP101 No.2
Setting for even attack of fingerpicking and arpeggio to get balanced tone. Also ideal for MTR.

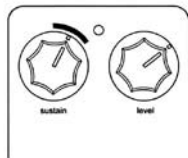

CP101 No.5
For smooth lead sound by adding CP101's sustain to amplifier's drive.

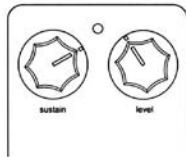

CP101 No.3
Setting for clean tone solo.
It makes clean + sustain tone that is characteristic of compressor.

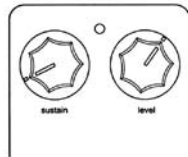

CP101 No.6
Setting to even out the chord riff attack in drive sound and arpeggio in clean sound.

CONNECTION DIAGRAM

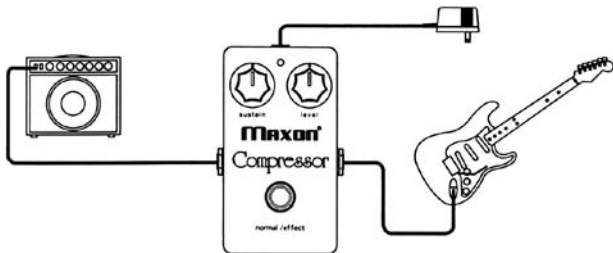

CP101 (COMPRESSOR)

SPECIFICATIONS

Input Impedance	: 500k ohms
Input Jack	: 1/4-inch standard phone jack
Output Impedance	: 10k ohms
Output Jack	: 1/4-inch standard phone jack
Control	: SUSTAIN, LEVEL
Switch	: normal / effect
Maximum Input Level	: 2dBu
Maximum Output Level	: 0dBu
Equivalent Input Noise	: -100dBu (IHF-A)
Compression Range	: 42dB
Power Supply	: One 9V battery or Maxon AC adaptor (option)
Power Requirements	: DC9-10V
Current Consumption	: 11mA (9V) / 12mA (10V)
Dimensions (main body)	: 61mm(W) x 112mm(D) x 35mm(H)
Dimensions (overall)	: 70mm(W) x 112mm(D) x 35mm(H)
Weight	: 9V battery (6LR61 or 6F22) x 1 or Maxon AC adaptor
Standard Accessories	: 270g
	: 9V manganese dry battery x 1, skid x 1

* Specifications are subject to change without notice.

※(0dBu=0.775Vms)

BATTERY REPLACEMENT

BATTERY REPLACEMENT

This product operates on one 9V battery (6LR61 or 6F22). Follow the procedures below to replace batteries:

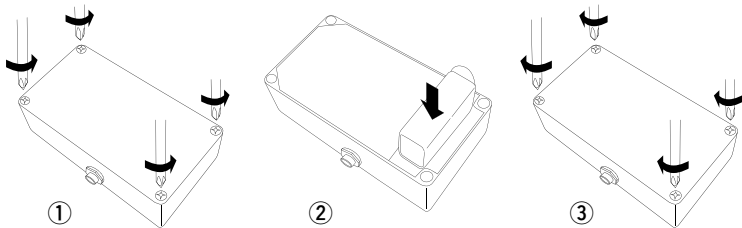

* Be sure the battery is firmly connected to battery snap with the correct polarities.

ATTENTION:

- Turn down the volume of effect and amplifier to the minimum before connecting Maxon effects to guitar, amplifier or other effects in order not to damage other connected equipment by unintended noise.
- When not in use, disconnect plug from input jack to preserve battery.
- Take out the battery if the product is not used for a long period of time.
- No or dark LED light indicates the battery is low or not installed. In this case replace the battery to avoid poor effect or distorted signal.
- Be sure to use the correct Maxon AC adaptor. Use of any other adaptor may cause trouble.
- Do not try to remove screws.



If you want to dispose this product, do not mix with general household waste.

There is a separate collection system for used electronics products in accordance with legislation under the WEEE Directive (Directive 2002/96/EC) and is effective only within European Union.

Optional accessories:
Maxon AC adaptor

model name	input	output	polarity
AC210N	120VAC	9VDC/200mA	 center-/sleeve+
AC210U	220VAC		
AC210UK (BS1363 plug)	230VAC		
AC210	100VAC	10VDC/200mA	

Maxon shall not be held liable to you or any third party for any losses caused by incorrect operation of this equipment, malfunction or any other failure of this equipment to operate as expected, or normal use of this equipment, except to the extent stipulated by law.

Maxon shall not be held liable to you or any third party for any losses related to concerts, exhibitions, or any other type of event due to malfunction or incorrect operation of this equipment.



NISSHIN ONPA CO., LTD.

4172-1 Shimauchi, Matsumoto-City, Nagano, 390-0851 Japan

TEL:+81-263-40-1403 FAX:+81-263-40-1410

www.maxon.co.jp sales@maxon.co.jp

For North America

www.maxonfx.com info@maxonfx.com

All specifications are subject to change for improvement without notice or obligation.
Sample setting by Shiro Tanigawa

Copyright 1999 - 2007 NISSHIN ONPA CO., LTD. All rights reserved.

UMN-FSE-0401A

Printed in Japan