

# Lexicon® PCM96 Surround

Reverb/Effects Processor

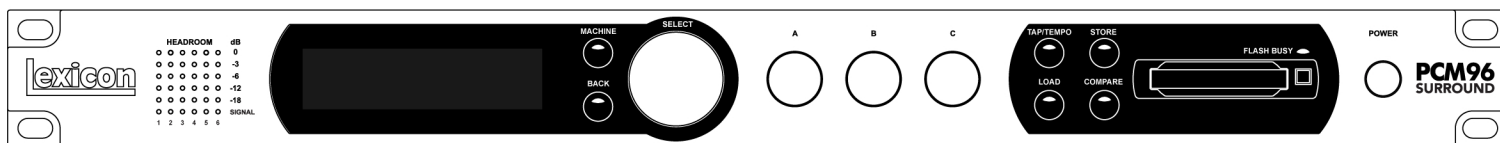

# IMPORTANT SAFETY INSTRUCTIONS



The symbols shown above are internationally accepted symbols that warn of potential hazards with electrical products. The lightning flash with arrowpoint in an equilateral triangle means that there are dangerous voltages present within the unit. The exclamation point in an equilateral triangle indicates that it is necessary for the user to refer to the owner's manual.

These symbols warn that there are no user serviceable parts inside the unit. Do not open the unit. Do not attempt to service the unit yourself. Refer all servicing to qualified personnel. Opening the chassis for any reason will void the manufacturer's warranty. Do not get the unit wet. If liquid is spilled on the unit, shut it off immediately and take it to a dealer for service. Disconnect the unit during storms to prevent damage.

## SAFETY INSTRUCTIONS

NOTICE FOR CUSTOMERS IF YOUR UNIT IS EQUIPPED WITH A POWER CORD.

**WARNING:** THIS APPLIANCE SHALL BE CONNECTED TO A MAINS SOCKET OUTLET WITH A PROTECTIVE EARTHING CONNECTION.

The cores in the mains lead are coloured in accordance with the following code:

**GREEN and YELLOW - Earth    BLUE - Neutral    BROWN - Live**

As colours of the cores in the mains lead of this appliance may not correspond with the coloured markings identifying the terminals in your plug, proceed as follows:

- The core which is coloured green and yellow must be connected to the terminal in the plug marked with the letter E, or with the earth symbol, or coloured green, or green and yellow.
- The core which is coloured blue must be connected to the terminal marked N or coloured black.
- The core which is coloured brown must be connected to the terminal marked L or coloured red.

This equipment may require the use of a different line cord, attachment plug, or both, depending on the available power source at installation. If the attachment plug needs to be changed, refer servicing to qualified service personnel who should refer to the table below. The green/yellow wire shall be connected directly to the units chassis.

CONDUCTOR		WIRE COLOR	
		Normal	Alt
L	LIVE	BROWN	BLACK
N	NEUTRAL	BLUE	WHITE
E	EARTH GND	GREEN/YEL	GREEN

**WARNING:** If the ground is defeated, certain fault conditions in the unit or in the system to which it is connected can result in full line voltage between chassis and earth ground. Severe injury or death can then result if the chassis and earth ground are touched simultaneously.

## WARNING FOR YOUR PROTECTION PLEASE READ THE FOLLOWING:

KEEP THESE INSTRUCTIONS

HEED ALL WARNINGS

FOLLOW ALL INSTRUCTIONS

THE APPARATUS SHALL NOT BE EXPOSED TO DRIPPING OR SPLASHING LIQUID AND NO OBJECT FILLED WITH LIQUID, SUCH AS VASES, SHALL BE PLACED ON THE APPARATUS.

CLEAN ONLY WITH A DRY CLOTH.

DO NOT BLOCK ANY OF THE VENTILATION OPENINGS. INSTALL IN ACCORDANCE WITH THE MANUFACTURER'S INSTRUCTIONS.

DO NOT INSTALL NEAR ANY HEAT SOURCES SUCH AS RADIATORS, HEAT REGISTERS, STOVES, OR OTHER APPARATUS (INCLUDING AMPLIFIERS) THAT PRODUCE HEAT.

ONLY USE ATTACHMENTS/ACCESSORIES SPECIFIED BY THE MANUFACTURER.

UNPLUG THIS APPARATUS DURING LIGHTNING STORMS OR WHEN UNUSED FOR LONG PERIODS OF TIME.

Do not defeat the safety purpose of the polarized or grounding-type plug. A polarized plug has two blades with one wider than the other. A grounding type plug has two blades and a third grounding prong. The wide blade or third prong are provided for your safety. If the provided plug does not fit your outlet, consult an electrician for replacement of the obsolete outlet.

Protect the power cord from being walked on or pinched particularly at plugs, convenience receptacles, and the point where they exit from the apparatus.

Use only with the cart stand, tripod bracket, or table specified by the manufacture, or sold with the apparatus. When a cart is used, use caution when moving the cart/apparatus combination to avoid injury from tip-over.



Refer all servicing to qualified service personnel. Servicing is required when the apparatus has been damaged in any way, such as power-supply cord or plug is damaged, liquid has been spilled or objects have fallen into the apparatus, the apparatus has been exposed to rain or moisture, does not operate normally, or has been dropped.

**POWER ON/OFF SWITCH:** The Power switch used in this piece of equipment DOES NOT break the connection from the mains.

**MAINS DISCONNECT:** The plug shall remain readily operable. For rack-mount or installation where plug is not accessible, an all-pole mains switch with a contact separation of at least 3 mm in each pole shall be incorporated into the electrical installation of the rack or building.

**FOR UNITS EQUIPPED WITH EXTERNALLY ACCESSIBLE FUSE RECEPTACLE:** Replace fuse with same type and rating only.

**MULTIPLE-INPUT VOLTAGE:** This equipment may require the use of a different line cord, attachment plug, or both, depending on the available power source at installation. Connect this equipment only to the power source indicated on the equipment rear panel. To reduce the risk of fire or electric shock, refer servicing to qualified service personnel or equivalent.

# IMPORTANT SAFETY INSTRUCTIONS

## DECLARATION OF CONFORMITY

Manufacturer's Name: Lexicon®  
Manufacturer's Address: 8760 S. Sandy Parkway  
Sandy, Utah 84070, USA

declares that the product:

Product name: PCM 96SUR  
Note: Product name may be suffixed by the EU.

Product option: None

conforms to the following Product Specifications:

Safety: IEC 60065 (7th ed. 2001)

EMC: EN 55013 (2001+A1)  
EN 55020 (1998)

Supplementary Information:

The product herewith complies with the requirements of the Low Voltage Directive 2006/95/EEC and the EMC Directive 2004/108/EC.

VP of Engineering  
8760 S. Sandy Parkway  
Sandy, Utah 84070, USA  
Date: November 20, 2008

European Contact: Your local Lexicon Sales and Service Office or

Harman Music Group  
8760 South Sandy Parkway  
Sandy, Utah 84070, USA  
Ph: (801) 566-8800  
Fax: (801) 566-7005

### ELECTROMAGNETIC COMPATIBILITY

This unit conforms to the Product Specifications noted on the **Declaration of Conformity**. Operation is subject to the following two conditions:

- this device may not cause harmful interference, and
- this device must accept any interference received, including interference that may cause undesired operation.

Operation of this unit within significant electromagnetic fields should be avoided.

- use only shielded interconnecting cables.

### U.K. MAINS PLUG WARNING

A molded mains plug that has been cut off from the cord is unsafe. Discard the mains plug at a suitable disposal facility. NEVER UNDER ANY CIRCUMSTANCES SHOULD YOU INSERT A DAMAGED OR CUT MAINS PLUG INTO A 13 AMP POWER SOCKET. Do not use the mains plug without the fuse cover in place. Replacement fuse covers can be obtained from your local retailer. Replacement fuses are 13 amps and MUST be ASTA approved to BS1362.



If you want to dispose this product, do not mix it with general household waste. There is a separate collection system for used electronic products in accordance with legislation that requires proper treatment, recovery and recycling.

Private household in the 25 member states of the EU, in Switzerland and Norway may return their used electronic products free of charge to designated collection facilities or to a retailer (if you purchase a similar new one).

For Countries not mentioned above, please contact your local authorities for a correct method of disposal.

By doing so you will ensure that your disposed product undergoes the necessary treatment, recovery and recycling and thus prevent potential negative effects on the environment and human health.

# Warranty

This warranty is valid only for the original purchaser and only in the United States. If outside the United States please contact the local Lexicon® distributor.

1. The warranty registration card that accompanies this product must be mailed within 30 days after purchase date to validate this warranty. Proof-of-purchase is considered to be the burden of the consumer.
2. Lexicon Professional warrants this product, when bought and used solely within the U.S., to be free from defects in materials and workmanship under normal use and service.
3. Lexicon Professional's liability under this warranty is limited to repairing or, at our discretion, replacing defective materials that show evidence of defect, provided the product is returned to Lexicon Professional WITH RETURN AUTHORIZATION from the factory, where all parts and labor will be covered up to a period of 1 year. A Return Authorization number must be obtained from Lexicon Professional by telephone. The company shall not be liable for any consequential damage as a result of the product's use in any circuit or assembly.
4. Lexicon Professional reserves the right to make changes in design or make additions to or improvements upon this product without incurring any obligation to install the same additions or improvements on products previously manufactured.
5. The foregoing is in lieu of all other warranties, expressed or implied, and Lexicon Professional neither assumes nor authorizes any person to assume on its behalf any obligation or liability in connection with the sale of this product. In no event shall Lexicon Professional or its dealers be liable for special or consequential damages or from any delay in the performance of this warranty due to causes beyond its control.

<b>INTRODUCTION.....</b>	<b>1</b>
<b>THE FRONT PANEL .....</b>	<b>3</b>
<b>THE REAR PANEL .....</b>	<b>5</b>
<b>USING THE PCM 96 .....</b>	<b>7</b>
Powering Up the PCM 96.....	7
The Preset Screen .....	7
Selecting Your Audio Source and Clock Source.....	8
Loading a Preset .....	8
Changing Categories .....	8
System Presets and Machine Presets .....	9
The configuration icon.....	10
Editing a Preset .....	11
Storing a Preset.....	12
Initializing/Formatting a Compact Flash Card .....	13
Creating a new System Preset .....	13
<b>DSP CONFIGURATIONS.....</b>	<b>14</b>
Super Stereo .....	14
Super Mono .....	14
Cascade Stereo.....	14
Cascade Mono.....	14
Mono to Stereo .....	14
Two Mono to Stereo.....	14
<b>THE PCM 96 PLUG-IN .....</b>	<b>15</b>
Installing the Plug-In software.....	15
Minimum System Requirements .....	15
Using the Plug-In.....	15
<b>NETWORKING.....</b>	<b>19</b>
Overview of TCP/IP Basics .....	19
Connecting the Computer Directly to the PCM 96.....	20
Setup of a Simple Isolated Ethernet Network	
Using DHCP .....	20
Virtual Private Networks (VPN) .....	21
Network Considerations and Limitations.....	21
Network Troubleshooting.....	21
<b>SYSTEM MENU .....</b>	<b>23</b>
Audio Setup .....	23
Machine Config .....	24
MIDI Control.....	24
Tempo Control.....	25
Card Config.....	25
Network Config.....	25
HiQnet Config.....	25
Restore Factory Defaults.....	25
<b>MACHINE MENU.....</b>	<b>26</b>
Soft Row Setup .....	26
I/O Levels .....	26
Various parameters .....	26
<b>USING MIDI .....</b>	<b>27</b>
MIDI Implementation .....	27
How to Load Presets with MIDI.....	27

How to Assign a Base Channel to the PCM96	
Surround .....	27
Channel Map (How Channels Map to Machines).....	28
Bank Dump .....	28
Reverse Bank Dump (Bank “Load”).....	28
Continuous Controllers.....	28
Soft Row Parameter/MIDI CC Map .....	29
Bank/Preset Map .....	29
MIDI SysEx Implementation .....	30
<b>THE ALGORITHMS.....</b>	<b>33</b>
Chamber (Stereo and Mono).....	33
Random Delay (Stereo and Mono).....	33
Hall (Stereo and Mono) .....	34
Random Hall (Stereo and Mono).....	35
Plate (Stereo and Mono).....	35
Dual Delay (Stereo and Mono) .....	35
Resonant Chords (Stereo and Mono) .....	36
Chorus/Flange (Stereo only).....	37
Concert Hall (Stereo only) .....	37
Room (Stereo and Mono).....	37
Signal Generator .....	37
<b>THE PARAMETERS .....</b>	<b>39</b>
<b>PCM96 SURROUND SPECIFICATIONS.....</b>	<b>53</b>
<b>MIDI IMPLEMENTATION CHART .....</b>	<b>56</b>

## **INTRODUCTION**

Congratulations and thank you for purchasing the PCM96 Surround Reverb/Multi Effects Processor! Building on the success of the PCM96, the new PCM96 Surround offers more presets, more configuration options, and more inputs and outputs. The PCM96 Surround gives you industry standard reverbs and effects, with tremendous flexibility. Use the PCM96 Surround as a plug-in with your DAW, or keep it connected to your mixer. Either way, you have a multitude of configuration options to choose from, without having to move any cables.

The PCM96 Surround is available with either 6 channels of XLR/AES inputs and outputs, or 2 DB25 6-channel analog I/O and 1 DB25 6-channel digital I/O. Both versions also feature MIDI, Wordclock, Ethernet, and FireWire®.

### **INCLUDED ITEMS**

- PCM96 Surround
- This owner's manual
- Standalone Application/FireWire driver CD
- Power Cord
- Lexicon Warranty Card
- Ethernet Cable





# THE FRONT PANEL

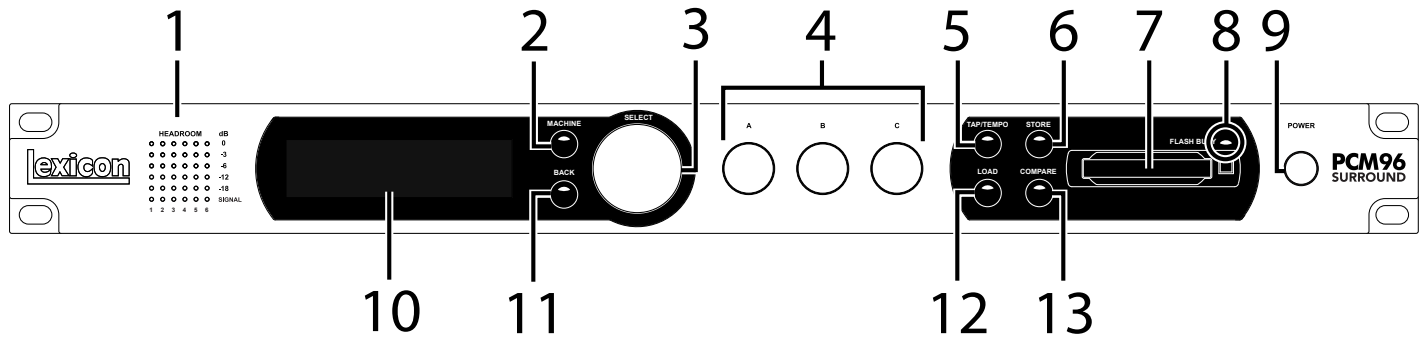

## 1. Gain LEDs

Each row of Gain LEDs indicates input signal strength of each of the PCM96 Surround's inputs. If the Audio Source is set to Analog (in the Audio Setup menu), they show analog levels. If Audio Source is set to Digital, they show digital levels. Range is from -18dB, -12dB, -6dB, -3dB, and 0dB.

## 2. MACHINE Button

The PCM96 Surround can be configured as a single system or as 1-4 "machines", each of which can run its own preset. The Machine button cycles the selected preset through its system and machine configurations.

## 3. SELECT Knob

Turn the Select knob to scroll through presets and menu options. Press the Select knob to select the current preset or menu option. Once you've selected a menu option, you can turn the Select knob to adjust the menu option's value (Press the Back button to accept the change.)

## 4. A, B, and C Knobs

These knobs adjust parameters shown in the Display. Turn Knob A to adjust the parameter in the top row, Knob B to adjust the parameter in the second row, and Knob C to adjust the parameter in the third row. Press Knob A to access additional pages of parameters when in the Soft Row. Press Knob C to view the current preset's Algorithm, Bank number, Program number, and MIDI channel. These knob also have additional context-sensitive functions when pressed.

## 5. TAP/TEMPO Button

Press two or more times to set tempo for delays and modulated effects. Look for presets with (T) in the name for effects that react to tempo.

## 6. STORE Button

Press to store a preset. When pressed, a menu appears in the Display where you can enter a new name for the preset.

## 7. Compact Flash Card Slot

Insert Compact Flash card here.

## 8. FLASH BUSY LED

This LED lights when the Compact Flash card is being read or written to.

Do not remove the Compact Flash card when this LED is lit.

### **9. Power Button**

Press to turn the PCM96 Surround on or off.

### **10. Display**

This high resolution, high contrast, and high viewing angle OLED (Organic LED) display shows menu and box configuration and status information.

### **11. BACK**

Pressing this button moves you up one level in the menu tree. Note that when a System preset is loaded, this button takes you to the System Mode Category Selection menu. When a Machine preset is loaded, the Back button takes you to the Machine Mode Category Selection menu.

### **12. LOAD**

Press this button to load the selected preset. You can also press the Select knob to load a preset.

### **13. COMPARE**

This button is used to compare an edited preset against its unedited self. When a preset is loaded, this button's LED is off. As soon as the preset is edited in any fashion, the LED lights. If the button is pressed, the edited state is temporarily stored and the preset is reloaded from the file system. During this period of time, editing is disallowed and the button LED blinks rapidly. When the Compare button is pressed a second time, the edited state is restored, editing is allowed again, and the LED is illuminated.

# THE REAR PANEL - DIGITAL MODEL

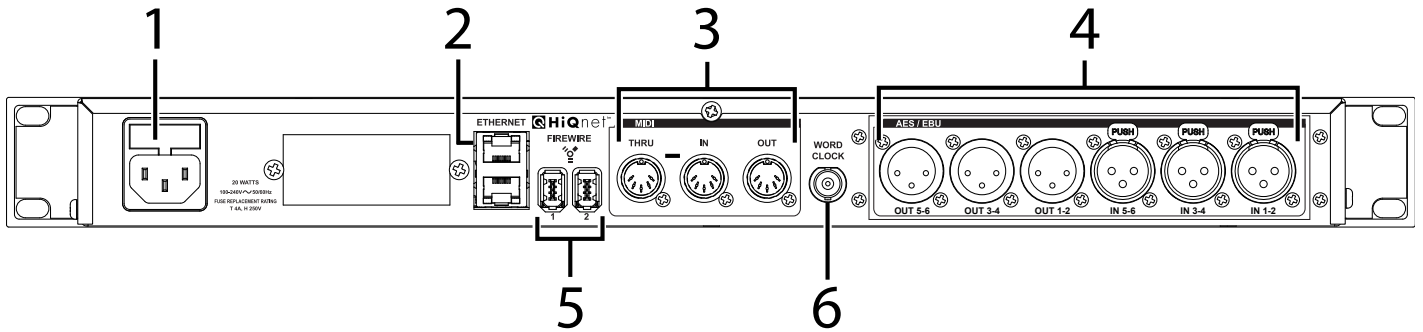

## 1. POWER JACK

Standard 3-pin IEC power connector. 100-240V, 50-60Hz automatic switching to correct voltage range.

## 2. ETHERNET INPUTS

These RJ-45 connections are used to network PCM96 Surround devices and control them via Ethernet.

## 3. MIDI IN

Receives MIDI information from other MIDI equipment such as master keyboard controllers, MIDI foot controllers, sequencers and synthesizers.

### MIDI THRU

Passes any MIDI data received without change.

### MIDI OUT

Transmits MIDI data to other equipment.

## 4. AES/EBU In/Out

AES/EBU format digital connectors conform to AES professional standards.

## 5. FIREWIRE™ PORTS

Connect FireWire™ cables here. Either port can be used, with the other acting as Thru.

## 6. WORD CLOCK INPUT

This connection allows the PCM96 Surround to lock to a master system clock. It is not terminated. For best results we recommend using “T” connectors when setting up a BNC Word Clock network and terminating the end of of this network with a 75 ohm BNC terminator.



# THE REAR PANEL - DIGITAL AND ANALOG MODEL

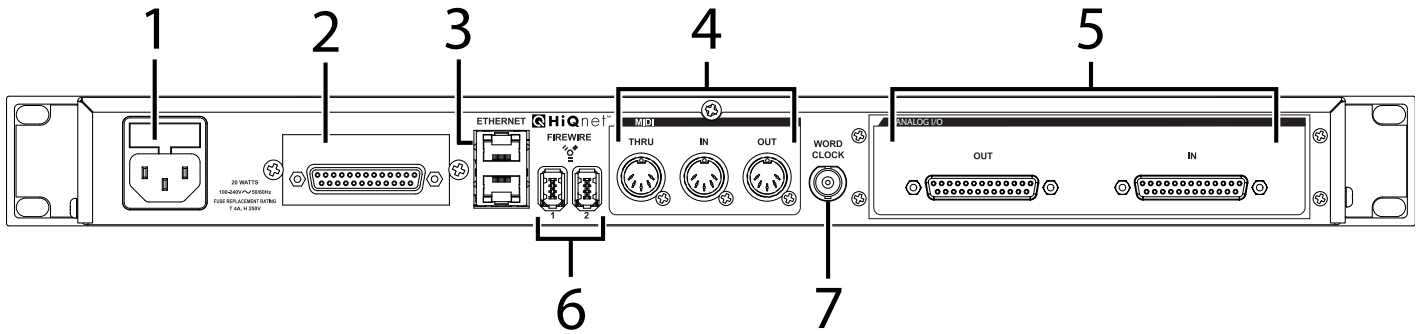

## 1. POWER JACK

Standard 3-pin IEC power connector. 100-240V, 50-60Hz automatic switching to correct voltage range.

## 2. DB25 6-CHANNEL DIGITAL AES I/O

This D25 connector carries six analog inputs and outputs.

## 3. ETHERNET INPUTS

These RJ-45 connections are used to network PCM96 Surround devices and control them via Ethernet.

## 4. MIDI IN

Receives MIDI information from other MIDI equipment such as master keyboard controllers, MIDI foot controllers, sequencers and synthesizers.

### MIDI THRU

Passes any MIDI data received without change.

### MIDI OUT

Transmits MIDI data to other equipment.

## 5. DB25 6-CHANNEL ANALOG IN/OUT

These D25 connectors each carry six analog inputs and outputs.

## 6. FIREWIRE™ PORTS

Connect FireWire™ cables here. Either port can be used, with the other acting as Thru.

## 7. WORD CLOCK INPUT

This connection allows the PCM96 Surround to lock to a master system clock. It is not terminated. For best results we recommend using “T” connectors when setting up a BNC Word Clock network and terminating the end of of this network with a 75 ohm BNC terminator.



# USING THE PCM96 SURROUND

## POWERING UP THE PCM96 SURROUND

1. Plug in the power cord.
2. Press the Power button.
3. The Lexicon® logo appears, and remains until the boot process is complete. Next, the Preset screen appears, showing the currently loaded preset.

## THE PRESET SCREEN

The Preset screen is the starting point for many of the instructions in this manual, so it's a good idea to know how to get to the Preset screen. In most cases, pressing the Back button one or more times will take you back to the Preset screen. If you press the Back button while viewing the Preset screen, you'll arrive at the Machine or System Category Selection screen. In this case, just turn the Select knob to select a category (the current category is marked with an asterisk), and press the Select knob to load it. You will then be taken to the Preset screen.

The Preset screen shows the current preset and configuration. Note that the Preset screen has two "views": *System view* (for System Presets) and *Machine view* (for Machine Presets). For more information about System and Machine Presets, see page 9.

### SYSTEM VIEW

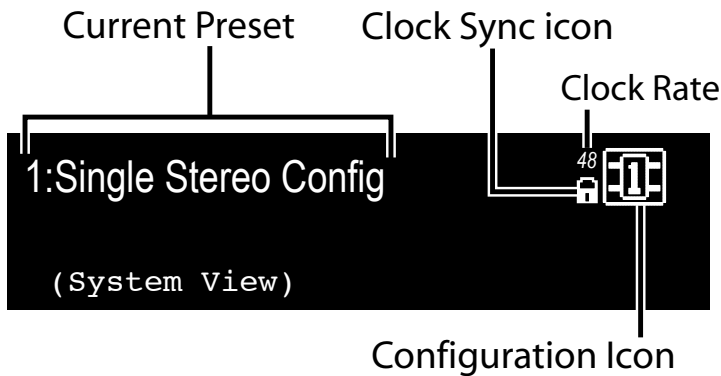

### MACHINE VIEW

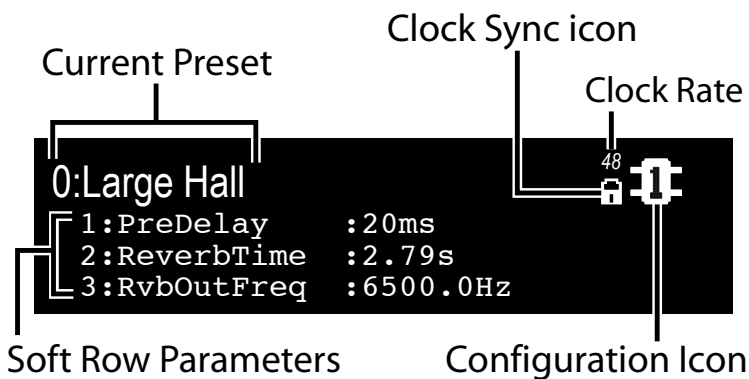

## SELECTING YOUR AUDIO SOURCE AND CLOCK SOURCE

1. Press the Machine button until the words “System View” appear in the Display.

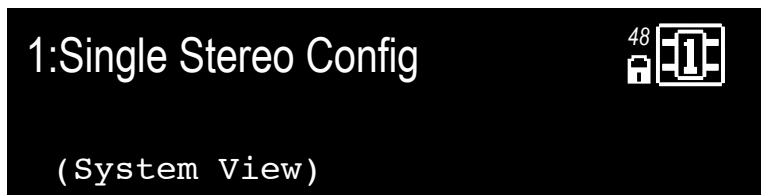

2. Press the Select knob. The System Menu appears.



3. With Audio Setup highlighted, press the Select knob. The Audio Setup menu appears.

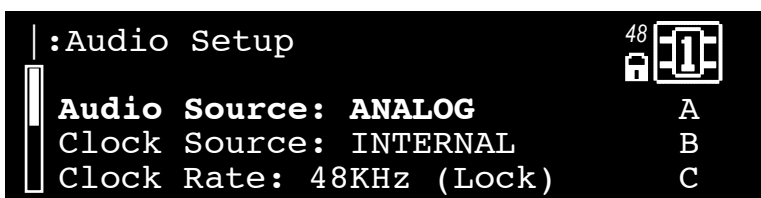

4. Turn Knob A to select your audio source (Analog or AES).
5. Turn Knob B to select your wordclock source (Internal, AES, or BNC).
6. Press the Back button twice to save your changes and return to the Preset screen.

## LOADING A PRESET

1. From the Preset screen, turn the Select knob to scroll through the available presets in the current category. (Presets are arranged in categories within the PCM96 Surround; see **Changing Categories** below for more information.) The preset name blinks after you turn the Select knob, indicating that you are in preset selection mode.
2. Press the Select knob to load the preset you've selected. The display briefly reads Loading Preset, and the preset name appears. It is no longer blinking.

## CHANGING CATEGORIES

Presets are grouped into categories in the PCM96 Surround. Each category has its own set of presets. When you turn the Select knob while viewing a preset, you only see presets available in the current category.

System Presets and Machine Presets each have their own set of categories. System Preset categories are based on DSP configurations (see page 14), and Machine Preset categories are based on algorithms (see page 33).



System Presets and Machine Presets also have User and Card categories, where you can access user-edited presets. Presets in the User category are stored on the PCM96 Surround, and presets in the Card category are stored on a Compact Flash card.

### To select a different category

1. From the Preset screen, press the Back button. The Category Selection screen appears. Note that there are different Category Selection screens for System Presets and Machine Presets:

#### Category Selection Screen - System Presets

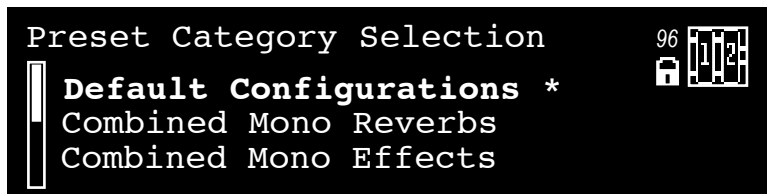

#### Category Selection Screen - Machine Presets

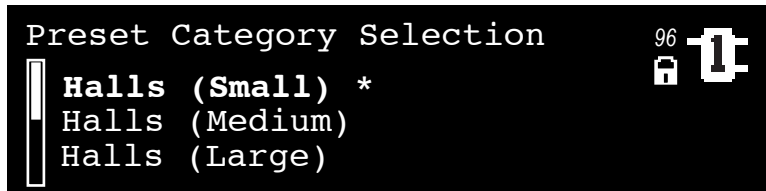

2. Turn the Select knob to scroll through the available categories. (An asterisk appears next to the currently selected category.)
3. Press the Select knob to load the highlighted category. A flashing preset name appears (if it is not the currently selected preset).
4. Select a preset with the Select knob, and press the Select knob to load it.

### SYSTEM PRESETS AND MACHINE PRESETS

The PCM96 Surround features a single powerful processor, which can be used as up to four *virtual machines*. For example, you could send the left input signal through a mono reverb in one virtual machine and send the right input signal through a mono delay in another virtual machine. You could then send both signals through a chorus effect on a third virtual machine. You could then save this configuration as a **System Preset**. It's a preset that includes a system of virtual machines. (Note that System Presets are not available in the PCM96 Surround plug-in. See page 15 for more information about the plug-in.)

System Presets can be extremely complex and are generally tailored especially for the mix you're working on. Lexicon® has provided a number of these presets, just to give you an idea about what you might do. Who knows? You might like them just the way they are. Feel free to make modified versions of the factory presets, or create your own from scratch. The possibilities are nearly endless, so have fun.

When a preset only includes a single virtual machine, it's called a **Machine Preset**.

Note that pressing the Back button or the Select knob have different results depending on what kind of preset is loaded. The following diagram shows what happens when you press the Select knob, Back button, and Machine button in both System View and Machine View.

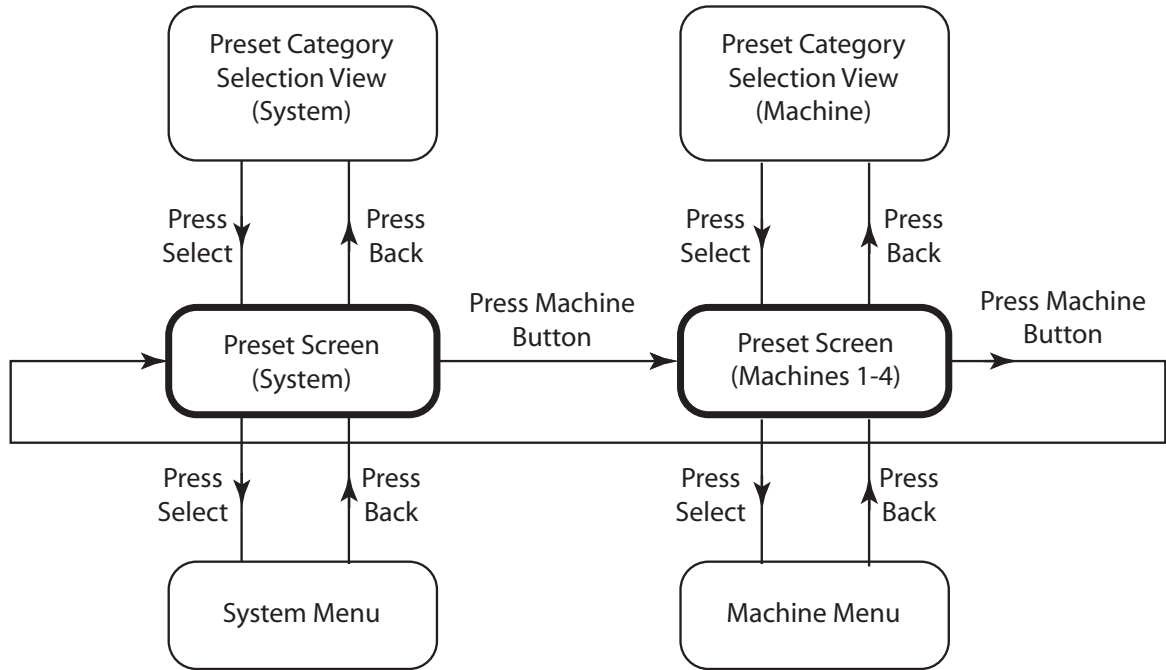

### THE CONFIGURATION ICON

The *Configuration icon* appears at the upper right corner of the Display. It tells you if a System Preset or a Machine Preset is loaded.

When a System Preset is loaded, a border appears around the Configuration icon and the words **System View** appear in the Display, below the preset's name.



Configuration Icon  
(System Preset)

When a Machine Preset is loaded, the selected machine is highlighted in the Configuration icon, and three of the loaded preset's parameters appear at the bottom of the Display.

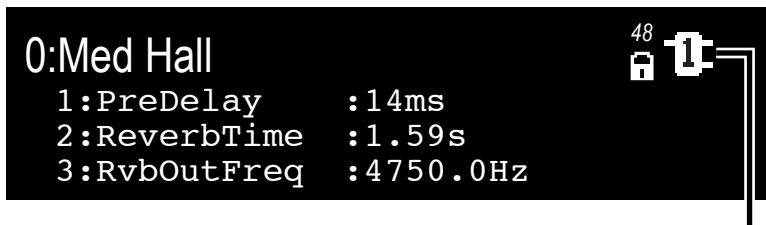

Configuration Icon  
(Machine Preset)

Press the Machine button repeatedly to cycle through the virtual machines in a System Preset, and eventually back to the System Preset.

### EDITING A PRESET

To edit a System Preset, you must edit the virtual machines within it. Press the Machine button to cycle through the virtual machines within a System Preset.

Each virtual machine contains a set of parameters that you can edit and adjust. When a virtual machine is selected, three of its parameters appear at the bottom of the Display. Adjust the first parameter with Knob A, the second parameter with Knob B, and the third parameter with Knob C. To see the next set of parameters you can adjust, **press** Knob A.

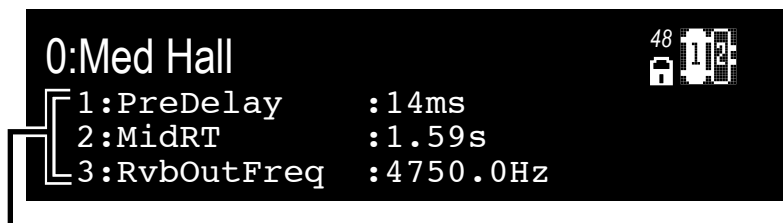

Soft Row Parameters

Each virtual machine has 8 parameters you can adjust this way. All presets have more than 8 parameters, but only 8 can be edited via the A, B, and C knobs in this fashion. You can choose which parameters are in the list by using the Soft Row Setup menu located in the Machine menu (see page 26 for more information).

## STORING A PRESET

Once you've edited a preset, you can store it on the PCM96 Surround (in the User category) or on a Compact Flash card (in the Card category).

**Note:** When you first insert a Compact Flash card, you may receive the message "Card Needs Initializing." Refer to page 13 for instructions on how to initialize a Compact Flash card.

1. From the Preset screen, press the Store button. The Save As screen appears.



```
Select Knob -> Change Position
'A' Knob -> Change Letter
Save As: Single Stereo Config
```

2. Turn the Select knob to select a letter to change.
3. Turn Knob A to change the selected letter.  
Press Knob A to toggle between uppercase, lowercase, special characters and numbers.  
Press Knob B to enter a space.  
Press Knob C to backspace.
4. Repeat steps 2 and 3 until you've changed all the letters you want to change.
5. Press the Select knob to continue. If a Flash card is inserted, the Location menu appears. (If no Flash card is inserted, skip to step 8.)



```
User
Card
```

6. Turn the Select knob to select a location. "User" is the PCM96 Surround built-in memory; "Flash" is the inserted Compact Flash card (if one is present).
7. Press the Select knob to continue. The numbered list appears.

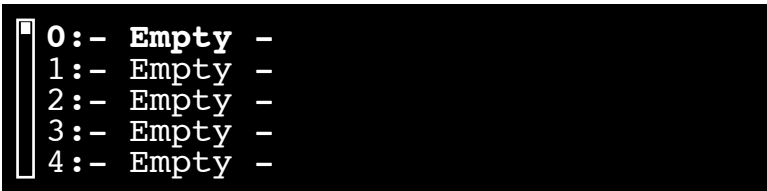

```
0:- Empty -
1:- Empty -
2:- Empty -
3:- Empty -
4:- Empty -
```

8. Turn the Select knob to select a slot in the numbered list. The preset's name automatically appears in the selected slot.
9. Press the Select knob to save the preset to the selected slot. "Storing Preset" appears briefly in the Display and you are returned to the Preset screen.

## **INITIALIZING/FORMATTING A COMPACT FLASH CARD**

To initialize or format a Compact Flash card:

1. Press the Back button until the Preset screen appears.
2. Press the Machine button until System View is displayed.
3. Press the Select knob to enter the System Menu.
4. Turn the Select knob until Card Config is highlighted.
5. Press the Select knob to access the Compact Flash Menu.
6. Press Knob B to Format the card OR press Knob C to initialize the card.

## **CREATING A NEW SYSTEM PRESET**

One way to create a new System Preset is to edit an existing System Preset and save it to the User or Card category. Another way is to start from scratch, as described below.

1. With any System Preset loaded, press the Select knob. The System menu appears.
2. Highlight Machine Config with the Select knob, and press the Select knob. The available DSP configurations appear.
3. Turn the Select knob to highlight a configuration and press the Select knob to choose it. You return to the Preset Screen. The preset's name indicates the configuration you just selected (for example, if you selected the Cascade Stereo configuration, the preset's name is Cascade Stereo Config).
4. Press the Machine button to select a Machine Preset within your System Preset.
5. Press the Back button to access the Preset Category menu.
6. Turn the Select knob to highlight a category and press the Select knob to choose it. A flashing Machine Preset name appears.
7. Turn the Select knob to choose a Machine Preset and press the Select knob to load it.
8. Press the Machine Button to choose the next Machine Preset (if there is one) and repeat steps 5 through 7.
9. Repeat step 8 for each virtual machine in your System Preset.
10. Press the Machine Button until your System Preset is selected.
11. Press the Store button and follow the Storing a Preset procedure described on page 12.

## DSP CONFIGURATIONS

The PCM96 Surround processor can be divided in up to four virtual machines, each of which can run its own algorithm. This lets you route signals from each input through a variety of algorithm combinations.

The PCM96 Surround can use up to six physical inputs and six physical outputs at a time; configurations for the physical inputs and outputs are described below. The software plug-in also lets the PCM96 Surround use up to six inputs and outputs via FireWire™; those configurations are accessible in the software plug-in, and are described on page 18.

When using the PCM96 Surround in one of its surround modes, it is critical to know how audio is routed to the algorithm. This applies both to the way IO connects with the outside world and the way the signals are distributed within the algorithm.

The inputs and outputs relate to the following cables:

	<b>Analog</b>	<b>AES</b>
Stereo Machine 1 Left	Cable 1	Cable 1 (L)
Stereo Machine 1 Right	Cable 2	Cable 1 (R)
Stereo Machine 2 Left	Cable 3	Cable 2 (L)
Stereo Machine 2 Right	Cable 4	Cable 2 (R)

Or

	<b>Analog</b>	<b>AES</b>
Multichannel Left	Cable 1	Cable 1 (L)
Multichannel Right	Cable 2	Cable 1 (R)
Multichannel Left Surround	Cable 3	Cable 2 (L)
Multichannel Right Surround	Cable 4	Cable 2 (R)
Multichannel Center	Cable 5	Cable 3 (L)
Multichannel LFE	Cable 6	Cable 3 (R)

### PRESET AVAILABILITY WITHIN THE VARIOUS SURROUND CONFIGURATIONS

In almost all cases, a surround preset is usable in any surround configuration, whether four or five-channel, 2-in or multi-in. Parameters which are not available in a given configuration (for example center levels in a four-channel config) are hidden. Factory presets have been written in such a way as to work satisfactorily in all configurations. When creating user presets, it's recommended that the preset be auditioned in all configurations.

### SIGNAL DISTRIBUTION INSIDE THE ALGORITHM

There are two versions of the 4-channel machine: 2-in/4-out and 4-in/4-out. By the same token, there are two versions of the 5-channel machine: 2-in/5-out and 5-in/5-out.

When dealing with true surround source material, the choice of configuration is simple--choose the 4-in or 5-in version. The algorithms are all designed to treat the inputs uniquely. If the algorithm is a reverberator or room, then each input will propagate into the space from the direction of its virtual source. If the algorithm is a delay or effect, each input will be treated by itself, and then possibly propagated into shared feedback paths.

But when dealing with stereo source material (the more typical case), some thought must be given to the choice of configuration. The 4-in or 5-in configuration may still be used of course, and the source material will be more obviously placed in the front of the virtual space. In the case of a delay or effects algorithm, not all voices will be activated. When the 2-in/multi-out configuration is chosen, the input signals are also propagated to the surround inputs (post level, post pan). This will sound different. A reverb may sound more full. It will still be surround of course, but will not maintain the same frontward localization. Delay and effects algorithms will now have all voices activated and may be considerably more complex. There may be a small difference in gain for the same presets in the 2-in or multi-in configuration.

There's no right or wrong in this choice. It's up to the user which of these configurations to use. But it is important to know how the sound will change based on this choice.

All the DSP configurations are described below.

### **SINGLE STEREO (MONO IN)**

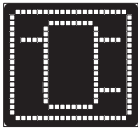

A mono signal is split into a stereo signal.

### **SINGLE STEREO**

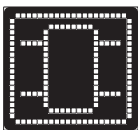

The left and right inputs are sent through a single virtual machine.

### **DUAL STEREO (MONO IN)**

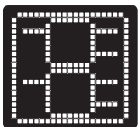

The left signal travels through one virtual machine, and the right signal travels through a separate second virtual machine.

### **DUAL STEREO**

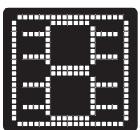

Two stereo signals are processed independently by two virtual machines.

### CASCADE STEREO

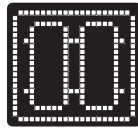

The left and right signals are processed together in one virtual machine, and the resulting signal is sent to a second virtual machine, where they are again processed together.

### DUAL MONO

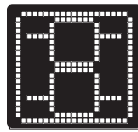

The left signal travels through one virtual machine, and the right signal travels through a separate second virtual machine.

### QUAD MONO

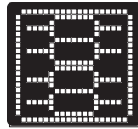

Four mono signals are processed independently by four virtual machines.

### CASCADE MONO

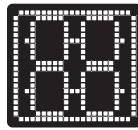

The left signal is sent through two virtual machines in sequence, while the right signal is sent through two additional virtual machines in sequence. The left and right signals are processed independent from each other.

### DUAL MONO + SINGLE STEREO

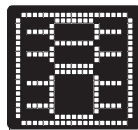

Two mono signals are processed independently by two virtual machines, while a stereo signal is processed by a third virtual machine.

### CASCADE MONO TO STEREO

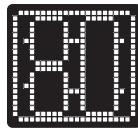

The left and right signals are processed independently in two separate virtual machines, and their resulting signals are processed together in a third virtual machine. The final result is output as stereo.

### SINGLE TWO IN FOUR OUT



Two signals are processed by one virtual machine, and output as four signals.

### SINGLE FOUR IN FOUR OUT

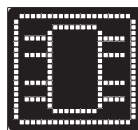

Four signals are processed by one virtual machine, and output as four signals.



### **SINGLE TWO IN FIVE OUT**

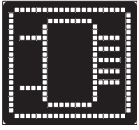

Two signals are processed by one virtual machine, and output as five signals.

### **SINGLE FIVE IN FIVE OUT**

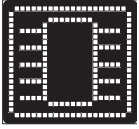

Five signals are processed by one virtual machine, and output as five signals.

### **SINGLE SIX IN SIX OUT**

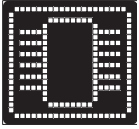

Six signals are processed by one virtual machine, and output as six signals.

## THE PCM96 SURROUND PLUG-IN

The plug-in lets you add PCM96 Surround reverbs and effects to projects on your Digital Audio Workstation (DAW).

### INSTALLING THE PLUG-IN SOFTWARE

To install the PCM96 Surround plug-in:

1. Double-click the PCM96\_Surround\_Installer x.x.x.x.dmg file (where “x.x.x.x.” is the version number) on the included DVD. The dmg file opens.
2. Double-click the PCM96\_Surround\_Installer x.x.x.x.dmg to begin the installer.
3. Follow the on-screen instructions to complete installation.
4. If you require RTAS support, open the PCM96\_Surround\_RTAS\_Installer package after installing the LexiconPro-x.x.x.x package and rebooting.

To uninstall the plug-in software, select Uninstall from the DVD and follow the on-screen instructions.

### Minimum System Requirements

Mac® OS 10.4.9 or higher

### USING THE PLUG-IN

Once you’ve created a project in your DAW and added an audio track, use your DAW to add an insert. Navigate to the PCM96 Surround menu and select any PCM96 Surround algorithm from the list. The PCM96 Surround plug-in window appears.

When you first open the PCM96 Surround plug-in, its default connection type is FireWire™. To change the connection type (and other settings) while using the plug-in, open the PCM96 Surround Control Panel, described on page 17.

Note that when you add a PCM96 Surround plug-in to your DAW, the PCM96 Surround display reads “Application Lockout” and displays the PCM96 Surround unit’s Node Name and Owner Node ID. You can change the Node Name and Node ID with the Control Panel (see page 17 for more information).

To exit Application Lockout, close your DAW or disconnect the cable connecting the PCM96 Surround to your computer.

### PLUG-IN WINDOW CONTROLS

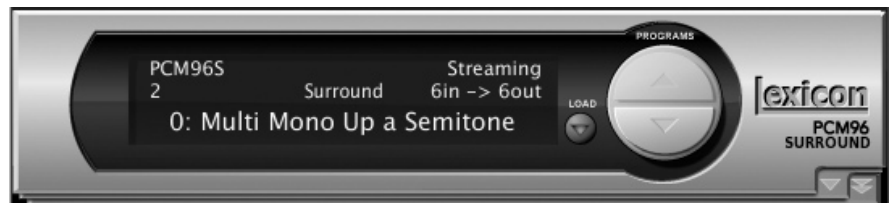

When the plug-in window first opens, it shows only a single control area. Here you can click the up and down Program arrows to scroll through the presets available for the selected algorithm, or click the Load button to select from a list. Click the Load button at the bottom of the list to load the selected preset, or click the Cancel button to cancel the selection.

Click the single down arrow in the lower right corner to open the second plug-in control area.



In the second control area, you can adjust the soft row parameters by clicking on and moving the sliders. Note that the soft row parameters vary from preset to preset. Click the down arrow in the lower right corner to open the third control area.



In the third control area (located at the bottom of the plug-in), you can adjust all the parameters in the preset by clicking on and moving the sliders. You can select different groups of parameters to adjust by clicking the buttons in the row at the top of the third control area (in the example above, I/O Levels, Input Control, Shape, etc.). Some parameters appear as drop-down menus; click the menu to open it, and click on an option to select it.

When you move a parameter's slider, an arrow appears where the slider's default position is. To return a preset to its default, click on the arrow or move the slider toward the arrow until the arrow disappears.

### THE PCM96 SURROUND PLUG-IN CONTROL PANEL

You can manage various network- and software-related aspects of the PCM96 Surround with the Control Panel. To open the Control Panel, click the PCM96SurroundControlPanel icon located in the System Preferences menu on your computer.



#### Repair

Click to re-initialize communication between the PCM96 Surround and your computer.

#### PCM96 Surround Communication

Click to check the connection status between the PCM96 Surround and your computer, and to open the PCM96 Surround Setup dialog (described on page 18).

#### About

Click to see the names of the PCM96 Surround development team, and to check for software updates.

#### Name

Assign a name to your PCM96 Surround to identify it on a network.

#### ID

Assign a number to your PCM96 Surround for network purposes.

#### Audio Source

Controls the PCM96 Surround unit's Audio Source parameter. Select Analog or AES.

#### Clock Source

Controls the PCM96 Surround unit's Clock Source parameter. Select Internal, AES or BNC.

#### Clock Rate

Controls the PCM96 Surround unit's Clock Rate parameter. Select 44.1 kHz, 48 kHz, 88.2 kHz, or 96 kHz.

### Locate

Click to make the PCM96 Surround display flash, so you can easily find the currently selected PCM96 Surround in a large rack full of PCM96 Surrounds.

### Update

Click to automatically update the PCM96 Surround software via the Internet.

### PCM96 SURROUND SETUP DIALOG

When you click the PCM96 Surround Communication button in the PCM96 Surround Control Panel, the PCM96 Surround Setup dialog appears.

#### Communications Interface

Select your computer's connection to the PCM96 Surround here. Choose from Firewire™ or "Ethernet X," where "X" is a number corresponding to your computer's network interface card.

#### Driver Buffer Setting

This control manages latency. Choose from Max Latency (highest latency, least chance of audio dropout), Slow (higher latency, less chance of audio dropout), Normal (medium latency, medium change of audio dropout), and DAW (lower latency, more chance of audio dropout).

#### FireWire Setting

Determines if the plug-in streams audio to and from the PCM96 Surround, or if the plug-in controls the PCM96 Surround without streaming audio. Choose from "Control And Audio" and "Control Only."

Note that when the PCM96 Surround is in Control Only mode, you may be prompted to "Select the PCM96 Surround you would like to connect to." When this happens, select the channel you'd like to apply the plug-in to.

#### Cancel

Click to cancel any changes you've made and return to the PCM96 Surround Control Panel.

#### Accept

Click to save any changes you've made and return to the PCM96 Surround Control Panel.

### STREAMING PLUG-IN CONFIGURATIONS

When the PCM96 Surround is used as a streaming plug-in, using FireWire I/O, the cascaded options will be unavailable. The increased channel count of the FireWire connection lets you use up to four simple mono or two simple stereo virtual machines at the same time. There are no cascade configurations available although effects can still be cascaded in the DAW.

- Single Stereo
- Two Stereo
- Dual Mono
- Four Mono
- Two Mono and One Stereo
- Single Two In Four Out
- Single Four In Four Out
- Single Two In Five Out
- Single Five In Five Out
- Single Six In Six Out

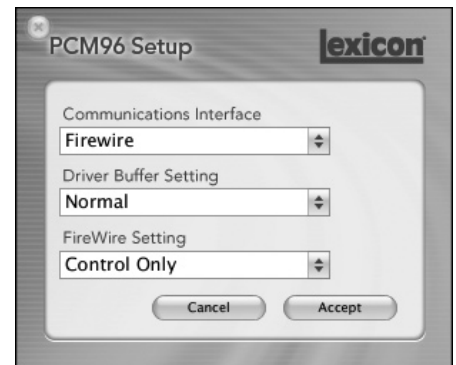

*The Setup Dialog*

## NETWORKING

This section provides a step-by-step guide on how to properly connect the PCM96 Surround to a Local Area Network (LAN) for several different network architectures. The first topology is a simple direct connection using the provided Ethernet cable. The second method describes how to connect and configure several PCM96 Surround units to create an isolated network using an Ethernet switch with static or with DHCP. This section concludes with some further networking considerations and troubleshooting tips that will help with connecting to your PCM96 Surround via Ethernet. If your application is more than these simple examples we recommend that you involve a trained Ethernet network administrator in the design and commissioning of your system.

Careful planning needs be made before placing a PCM96 Surround on a network that provides any access to the public. Some examples of public access are direct access to the unit from the Internet, an unsecured or weakly secured wireless network, a network jack in a public area that provides network access to the PCM96 Surround, or having a computer on the LAN that is not secured so that someone could use it to reconfigure the PCM96 Surround. It is highly recommended that the equipment be placed on a protected, isolated network that does not have any connection to the public to prevent unauthorized users from reconfiguring the unit. Please refer to the VPN portion of this section for more information. Factory defaults for the Internet Protocol (IP) settings for the PCM96 Surround are as follows:

Auto-IP/DHCP Address:	169.254.x.x (where “x.x” is determined by the PCM96 Surround box numbers)
Subnet Mask:	255.255.0.0
Gateway:	0.0.0.0
DHCP Support:	Enabled

### OVERVIEW OF TCP/IP BASICS

#### IP ADDRESS

An identifier for a computer or device on a TCP/IP network. Each device in a network has its own IP address to identify it. Example: 126.126.17.42. Networks using the TCP/IP protocol route messages based on the IP address of the destination. An IP address is made of four numbers separated by periods. Each number can be zero to 255. The last number should not be a zero or 255. For example, 126.126.17.1 could be an IP address. 126.126.17.0 would not be a valid IP address. A TCP/ IP or IP address has two parts: the NETWORK ID and the HOST ID. The NETWORK ID identifies the network, and the HOST ID identifies either the subnet and device, or just the device if there is no subnet. The subnet mask is a code that indicates which part of the TCP/IP address is the NETWORK ID and which part is the HOST ID. In subnet-mask code, 255 means “This part of the address is the NETWORK ID”. Example: Suppose the IP ADDRESS of a device is 192.168.xx.yy and the SUBNET MASK is 255.255.x.y. That means, (192.168) is the NETWORK ID. The remaining set of numbers (xx.yy) is the HOST ID. If your network stands alone (it is not part of a larger network) then the HOST ID identifies each device in the network. If your network is part of a venue’s larger network, your network is actually a sub-network or subnet.

## **SUBNET**

A small network within a larger network. For example, a TCP/IP network might be a subnet of a venue's network, which could include computers throughout the building, or a network might be divided into subnets. For example, in a large installation, there may be one subnet per rack or room.

## **DHCP (DYNAMIC HOST CONFIGURATION PROTOCOL)**

This is a protocol for automatically assigning IP addresses to devices on a network. With dynamic (DHCP) addressing, a device might have a different IP address every time it connects to the network. DHCP relies on a DHCP server to assign and manage IP addresses.

## **AUTO IP**

If DHCP fails, the PCM96 Surround selects a number and looks for collisions. If no collisions are found, the PCM96 Surround accepts that number. If collisions are found, the PCM96 Surround randomly selects another number and tries again.

## **CONNECTING THE COMPUTER DIRECTLY TO THE PCM96 SURROUND**

Assumptions:

- Using OS-X 10.4 or later.
  - Computer has a working Ethernet network adapter.
  - You have administrative rights so that network settings can be changed if necessary.
1. Connect the included Ethernet cable to both the PCM96 Surround and the computer.
  2. Apply power to the PCM96 Surround and wait for it to boot.
  3. Open the standalone application.

## **SETUP OF A SIMPLE ISOLATED ETHERNET NETWORK USING DHCP**

Assumptions:

- Using OS-X 10.4 or later.
  - Computer has a working Ethernet network adapter.
  - You have an Ethernet switch/router with DHCP capability and Ethernet cables for each connection needed.
  - You have administrative rights so that network settings can be changed if needed.
  - The Ethernet network consists of exactly one computer that will be used to run the PCM96 Surround configuration software and one or more PCM96 Surround units.
1. Connect the computer and any PCM96 Surround to the switch hub using normal Ethernet cables.
  2. Apply power to all PCM96 Surrounds and wait for them to boot.
  3. With DHCP enabled, the Ethernet switch/router should assign an IP address to each of the devices including your computer.
  4. The PCM96 Surround units should come up in the main window.

## **VIRTUAL PRIVATE NETWORKS (VPN)**

Virtual private networks (VPN) provide an encrypted connection (or tunnel) between networks or between a network and a user over a public network (such as the Internet). Instead of using a dedicated, real-world connection such as a leased line, a VPN uses virtual connections through the public network. The advantage to a VPN is that your computer can be virtually connected to a local network even though it is physically anywhere in the world where you have an internet connection. This can also be done in a safe manner not compromising your local network's security. If you would like to manage your PCM96 Surround units remotely you should create a secure VPN connection.

There are many solutions on the market today that provide VPN access. These products offer different features, methods of VPN, complexity of setup and maintenance, as well as varying levels of security. It is beyond the scope of this manual to recommend a VPN solution that will best suit the needs of your network, although you will need a VPN that is capable of passing UDP and TCP traffic (most do). The PCM96 Surround has been tested against several solutions and should work with all VPNs that meet these criteria. Please work with your system administrator and Internet service provider to find a VPN that will best fit your network. The 3Com OfficeConnect Secure Router (model # 3CR860-95) is one solution that has been tested, and is both inexpensive and simple to set up. It provides up to two concurrent VPN connections.

## **NETWORK CONSIDERATIONS AND LIMITATIONS**

- Without a VPN, there can be no access from the outside world to any PCM96 Surround that is behind a Network Address Translation (NAT) router. (One-to-One NAT and port forwarding will not work.)
- Firewall Considerations: The PCM96 Surround uses port 3804 (udp and tcp) to communicate with the System Architect software. Make sure that you configure your firewalls correctly so that data sent to and from this port number can traverse your network.

## **NETWORK TROUBLESHOOTING**

If you are having difficulty getting your PCM96 Surround to show up in your System Architect software, here are some things that you can try to resolve the problem.

### **SOFTWARE FIREWALL**

If the PC that you have installed the System Architect software on has a built-in firewall you need to make sure that you allow the software the ability to talk on your network. Try disabling your firewall and then going offline and back online in the System Architect software. If this fixes the problem, refer to your firewall manufacturer's documentation on how to reconfigure



your firewall to allow the System Architect software and/or port 3804 tcp and udp to pass through the firewall.

### **ETHERNET LINK**

Make sure that you have a valid Ethernet connection by looking at the link status lights. Most Ethernet devices will have some kind of indicator that shows the link is present. Check the following connections:

- PCM96 Surround device – If there is a valid connection on the PCM96 Surround you will see a solid green LED.
- PC running the System Architect software
- Hub / Switch (if used)

If you fail to see a link light try removing and reinserting the cable or trying a different, known good, cable. Also, make sure that you are using the correct cable.

### **PING**

There is a simple utility built into OS-X that tests the network connection between two devices. The following steps outline how to use this utility.

1. In the Applications folder, double click the Terminal icon.
2. At the prompt enter `ping -c 4 <IP address of your PCM96 Surround>` and press Enter. The data should appear something like this:

```
PING <IP address of your PCM96 Surround>: 56 data bytes
64 bytes from <IP address of your PCM96 Surround>: icmp_seq=0 ttl=62
time=1.118 ms
64 bytes from <IP address of your PCM96 Surround>: icmp_seq=1 ttl=62
time=1.093 ms
64 bytes from <IP address of your PCM96 Surround>: icmp_seq=2 ttl=62
time=1.067ms
64 bytes from <IP address of your PCM96 Surround>: icmp_seq=3 ttl=62
time=1.042ms
```

```
--- <IP address of your PCM96 Surround> ping statistics ---
4 packets transmitted, 4 packets received, 0% packet loss
round-trip min/avg/max = 1.042/1.08/1.118 ms
```

If you get a “Reply from” response from the IP address that you were ping- ing in a timely manner, it means that you have a valid network connection between the two devices.

If you receive a “No route to host” or “0 packets received” message, this indi- cates that your computer is not communicating with the device.

## SYSTEM MENU

The System Menu lets you adjust several settings in the PCM96 Surround. To access the System Menu, press the Select knob while a System Preset is loaded.

The System Menu contains *sub-menus* and *options*. Sub-menus contain options and/or more sub-menus. To enter a sub-menu, highlight it with the Select knob and press the Select knob. Options contain values that you can adjust (indicated by a colon followed by a value, for example, “Audio Source: ANALOG”). To adjust an option’s value, turn the corresponding knob: Knob A for an option on the first line, Knob B for an option on the second line, and Knob C for an option on the third line. Press the Back button at any time to save your changes and move one level up through the menus and sub-menus.

### AUDIO SETUP

The Audio Setup sub-menu contains the following options:

#### Audio Source

This is a global setting that configures the PCM96 Surround to accept ANALOG or AES input.

#### Clock Source

Select your clock source here. Choose from INTERNAL, AES, and BNC.

#### Clock Rate

Select your clock rate here, when the wordclock source is set to INTERNAL. Choose from 44.1KHz, 48KHz, 88.2KHz, or 96KHz.

#### Analog Setup

The Analog Setup sub-menu lets you adjust the following parameters:

Analog Input Level - Increases or decreases the incoming analog signal before it reaches the processor(s). Set to +4dBu or -10dBu.

Analog Output Level - Increases or decreases the outgoing analog signal after it leaves the processor(s). Set to +4dBu or -10dBu.

Global Mute - Mutes all signals from the PCM96 Surround. Set to Muted or Unmuted.

#### AES Setup

The AES Setup sub-menu gives you the status of the following AES information:

Data Validity - “Valid” indicates the data is OK. “Invalid” indicates that the Validity bit was set in a frame of incoming data and that the data attached to it may be corrupted. This bit may also be sent when the transmitting device is paused.

Mode - Select “Consumer” to send information in S/PDIF format. Select “Professional” to send information in AES format.

Confidence Error - “0” indicates no problem. “1” indicates the PCM96 Surround is detecting excessive jitter or noise on the digital audio line. No data has been corrupted, but corrective action should be taken.

Sample Slip - An unchanging number indicates you are not slipping samples. An increasing number indicates samples are misaligned with the window defined by the Input Source. This may occur when an external master changes sample rate, or when it is just powering up, but should not occur in normal operation.

Bi-Phase Error - “0” indicates no problem. “1” indicates that at least one bit (and therefore at least one audio sample) was corrupted.

CRC Error - “0” indicates no problem. “1” indicates a Cyclic Redundancy Check error in the incoming data.

Parity Error - “0” indicates no problem. “1” indicates that at least one bit (and therefore at least one audio sample) was corrupted.

## **MACHINE CONFIG**

The Machine Config menu lets you configure the PCM96 Surround processor as one, two, three, or four virtual machines in a new preset. Note that once you’ve selected a configuration, you must then populate each virtual machine with a Machine Preset (see page 11 for more information).

Choices include:

- Single Stereo (MonoIn)**
- Single Stereo**
- Dual Stereo (MonoIn)**
- Dual Stereo**
- Cascade Stereo**
- Dual Mono**
- Quad Mono**
- Cascade Mono**
- Dual Mono + Single Stereo**
- Cascade Mono to Stereo**
- Single Two In Four Out**
- Single Four In Four Out**
- Single Two In Five Out**
- Single Five In Five Out**
- Single Six In Six Out**

For more detailed descriptions of each configuration, see page 14.

## **MIDI CONTROL**

The MIDI Control sub-menu lets you adjust the following MIDI-related options:

### **MIDI**

Turns MIDI processing on or off.

### **Device ID**

Select the connected MIDI device’s ID here. Choose from 0-126.

### **Base Channel**

Select the connected MIDI device's base channel here. Choose from 0-15.

### **Bank Dump**

Lets you copy an entire bank of presets from the PCM96 Surround to another device via MIDI. (For a map of banks and presets, see page 29; to see the current preset's bank number, press Knob C while viewing the Preset screen.) When Bank Dump is highlighted, turn the corresponding B or C Knob to select a bank. Press the corresponding B or C Knob to send the bank to the connected device.

## **TEMPO CONTROL**

The Tempo Control sub-menu contains the following options:

### **Tempo Value**

Set the current preset's tempo here by turning Knob A, or by pressing the Tap Tempo button at least two times.

### **Tempo Beat**

Tempo is expressed in BPM. This control allows you to specify the value of the beat. Eighth, quarter, and half note values are available. If, for example, the rate is 120 BPM, and you select eighth-note here, the tempo will be 120 eighth-notes per minute. If you select quarter-note here, the tempo will be 120 quarter-notes per minute. (The factory default is quarter-note.)

### **Tempo Source**

Select INTERNAL to determine the tempo using parameters within the PCM96 Surround, or MIDI to set the tempo using MIDI beat clock. Refer to your DAW's manual to learn how to transmit this value.

## **CARD CONFIG**

The Compact Flash Setup sub-menu indicates whether a Compact Flash card is INSERTED or NOT INSERTED, and gives you the options to Format (erase) the inserted card by pressing Knob B, or initializing the inserted card by pressing Knob C.

## **NETWORK CONFIG**

Here you can set the PCM96 Surround Subnet Mask, IP Address, Gateway, and DHCP information. Turn the Select knob to select a three-digit number (of the DHCP value) and turn Knob A to change the number (or the DHCP value). See the Networking section on page 19 for more details.

## **HIQNET CONFIG**

Set the HiQnet Negotiation Mode (Static, Random, or Sequential) and Node Address here. Turn the Select knob to underscore a value and turn Knob A to change the value.

## **RESTORE FACTORY DEFAULTS**

Returns the PCM96 Surround to its original state as shipped from the factory.

## MACHINE MENU

The Machine menu lets you adjust settings for a single virtual machine. To access the Machine menu, press the Select knob while a Machine Preset is loaded.

The sub-menus vary depending on what algorithm is active.

### SOFT ROW SETUP

This sub-menu lets you assign parameters to a Machine Preset's soft row. The soft row is the list of parameters that appears below a Machine Preset's name in the Preset screen. You can easily adjust these parameters with the A, B, and C knobs (press Knob A to see more parameters in the soft row).

### I/O SETTINGS

Here you can adjust the following settings (depending on the selected preset):

#### Wet Dry Mix

Adjusts the proportion of wet (processed) signal to dry (unprocessed) signal. Ranges from 0% (all dry) to 100% (all wet). In almost all cases you will leave this at 100%, and control levels on your mixer.

#### Input Level

Controls the amount of signal admitted into the process from the input. Ranges from 0.0dB INV to -90.0dB INV or OFF INV, and from -90.0dB or OFF to 0.0dB.

#### Output Level

Controls the amount of post-mix signal emitted onto the output. Ranges from -90.0dB or OFF to 0.0dB.

### VARIOUS PARAMETERS

The sub-menus that appear below the I/O Settings sub-menu depend on the active algorithm. Refer to the Parameters section on page 39 for more information.

## USING MIDI

The MIDI Control menu is where all MIDI related control is changed. See page 24 for information about the MIDI Control menu.

### MIDI IMPLEMENTATION

The PCM96 Surround offers MIDI implementation for use with external MIDI hardware and software controllers. You can connect up to three PCM96 Surround units to a single MIDI controller. You can also slave two or more PCM96 Surround units together by connecting a cable from the MIDI Out port of the master to the MIDI In port of the slave. Additional PCM96 Surround units can be slaved to the master by connecting a cable from the MIDI Thru port of one slave unit to the MIDI In port of the next unit.

The MIDI implementation for the PCM96 Surround is very basic. The implementation is fixed, but there is a user interface for modifying basic parts of it.

### NOMENCLATURE

Numbering in MIDI (channel number and program numbers, for example), can be confusing since some sources start counting from zero and others start from one. This description will start from zero.

### HOW TO LOAD PRESETS WITH MIDI

Because of the large number of potential presets in the PCM96 Surround, Preset Change messages are used along with the Bank Select extension to provide MIDI preset selection. Controller 32 is used to select the current preset bank. Controller 32 is sent to the system (to select the desired bank), followed by a Preset Change message to select a preset. The Bank values are “sticky,” meaning the PCM96 Surround will remember the Bank values for each MIDI channel. It is not necessary to send a Bank change with each Preset Change unless the Bank has indeed changed.

See page 29 for a bank/preset map. To see a preset’s bank on the PCM96 Surround, press Knob C while viewing the Preset screen.

### HOW TO ASSIGN A BASE CHANNEL TO THE PCM96 SURROUND

The base channel identifies a PCM96 Surround unit to a MIDI device. Add 1, 2, 3, or 4 to the unit’s base channel to identify virtual machines within the unit. You can connect up to three PCM96 Surround units to a single MIDI device.

To assign a base channel to the PCM96 Surround:

1. Press the Back button until the Preset screen appears.
2. Press the Machine button until System View is displayed.
3. Press the Select knob to enter the System Menu.
4. Turn the Select knob until Midi Control is highlighted.
5. Press the Select knob to access the Midi Control Menu.
6. Turn the Select knob until Base Channel is highlighted.
7. Turn Knob B to select the base channel (0-15).
8. Press the Back button twice to return to the Preset screen.

Now the PCM96 Surround unit is identified by the selected base channel, and virtual machines 1, 2, 3, and 4 within the PCM96 Surround are identified by the base channel plus 1, 2, 3, and 4, respectively.

### CHANNEL MAP (HOW CHANNELS MAP TO MACHINES)

Channel	Usage	Description
Base Channel	System Level	Use for loading System presets. This is the PCM96 unit's base channel. The next four channels apply to this PCM96 unit's virtual machines.
Base + 1	Virtual machine 1	Changes parameters in one virtual machine in a System preset on the PCM96 unit with base channel 0. Use for loading machine presets and changing parameters for machine #1.
Base + 2	Virtual machine 2	Changes parameters in one virtual machine in a System preset on the PCM96 unit with base channel 0. Use for loading machine presets and changing parameters for machine #2.
Base + 3	Virtual machine 3	Changes parameters in one virtual machine in a System preset on the PCM96 unit with base channel 0. Use for loading machine presets and changing parameters for machine #3.
Base + 4	Virtual machine 4	Changes parameters in one virtual machine in a System preset on the PCM96 unit with base channel 0. Use for loading machine presets and changing parameters for machine #4.

### BANK DUMP

The Bank Dump feature lets you copy all the presets in a User bank from one PCM96 Surround to another (or to another MIDI device). Refer to the MIDI Control section on page 24 for information about Bank Dump.

### REVERSE BANK DUMP (BANK "LOAD")

You can perform a "reverse bank dump" by recording a bank dump to your MIDI sequencer, then playing that sysex back to the PCM96 Surround to restore the bank.

### CONTINUOUS CONTROLLERS

All PCM96 Surround soft row parameters can be controlled with single, 7-bit controllers. Each parameter is controlled with the full controller range, regardless of the parameter range. For example, if the controller is at the midpoint of its range (64), the parameter will also be at the midpoint of its range no matter what the actual number.

Continuous Controllers range from 0 to 127. If the parameter range is less than 127, then a small controller change might not result in a parameter update. But the entire range of the parameter can still be accurately controlled. In addition, if the actual range of the parameter is greater than 127, MIDI control might be somewhat coarse. This is most noticeable with large delays.

When MIDI is enabled, the PCM96 Surround automatically sends MIDI messages through the MIDI Out port for soft row parameters and preset

loads whenever those actions are performed via the front panel controls.

### SOFT ROW PARAMETER/MIDI CC MAP

Soft Row Parameter	MIDI CC
Parameter #1	CC 48
Parameter #2	CC 49
Parameter #3	CC 50
Parameter #4	CC 51
Parameter #5	CC 52
Parameter #6	CC 53
Parameter #7	CC 54
Parameter #8	CC 55

### BANK/PRESET MAP

Bank	Presets	Bank #
Mono Internal Flash Bank 1	Mono User Onboard Flash Category Presets 1 – 128	72
Mono Internal Flash Bank 2	Mono User Onboard Flash Category Presets 129 – 256	73
Stereo Internal Flash Bank 1	Stereo User Onboard Flash Category Presets 1 – 128	74
Stereo Internal Flash Bank 2	Stereo User Onboard Flash Category Presets 129 – 256	75
System Internal Flash Bank 1	System User Onboard Flash Category Presets 1 – 128	76
System Internal Flash Bank 2	System User Onboard Flash Category Presets 129 – 256	77
Surround Internal Flash Bank 1	Surround User Onboard Flash Category Presets 1 – 128	78
Surround Internal Flash Bank 2	Surround User Onboard Flash Category Presets 129 – 256	79
Mono Compact Flash Card Bank 1	Mono User Compact Flash Category Presets 1 – 128	100
Mono Compact Flash Card Bank 2	Mono User Compact Flash Category Presets 129 – 256	101
Mono Compact Flash Card Bank 3	Mono User Compact Flash Category Presets 257 – 384	102
Mono Compact Flash Card Bank 4	Mono User Compact Flash Category Presets 385 – 512	103
Stereo Compact Flash Card Bank 1	Stereo User Compact Flash Category Presets 1 – 128	104
Stereo Compact Flash Card Bank 2	Stereo User Compact Flash Category Presets 129 – 256	105
Stereo Compact Flash Card Bank 3	Stereo User Compact Flash Category Presets 257 – 384	106
Stereo Compact Flash Card Bank 4	Stereo User Compact Flash Category Presets 385 – 512	107
System Compact Flash Card Bank 1	System User Compact Flash Category Presets 1 – 128	108
System Compact Flash Card Bank 2	System User Compact Flash Category Presets 129 – 256	109
System Compact Flash Card Bank 3	System User Compact Flash Category Presets 257 – 384	110
System Compact Flash Card Bank 4	System User Compact Flash Category Presets 385 – 512	111
Surround Compact Flash Card Bank 1	Surround User Compact Flash Category Presets 1 – 128	112
Surround Compact Flash Card Bank 2	Surround User Compact Flash Category Presets 129 – 256	113
Surround Compact Flash Card Bank 3	Surround User Compact Flash Category Presets 257 – 384	114
Surround Compact Flash Card Bank 4	Surround User Compact Flash Category Presets 385 – 512	115



## MIDI SYSEX IMPLEMENTATION

### COMMAND 0: REQUEST PRESET DUMP

When this command is received by the PCM96 Surround, it will respond with a preset dump of the requested preset. If the preset does not exist, the PCM96 Surround will not respond. Only presets from User banks may be requested. Factory banks will not be transmitted.

Byte	Definition	Comments
0xF0	Sysex message	
0x06	Lexicon® Manufacturer ID	
0x__	Product ID	0x21
0x__	Device ID	
0x00	Command	Request Preset Dump
0x02	Size	LSB
0x00	Size	cont
0x00	Size	cont
0x00	Size	MSB
0x__	Bank	Bank in which requested preset lives.
0x__	Preset	Preset ID
0xF7	EOX	

### COMMAND 1: PRESET DUMP

This sysex is transmitted by a MIDI sequencer or by PCM96 Surround. The PCM96 Surround may transmit this dump in response to a request or by means of a front-panel action. The PCM96 Surround receiving this dump will store the encapsulated preset data in the designated location.

Byte	Definition	Comments
0xF0	Sysex message	
0x06	Lexicon Manufacturer ID	
0x__	Product ID	0x21
0x__	Device ID	
0x01	Command	Preset Dump
0x__	Size	LSB. Size is variable and is not shown in this example
0x__	Size	cont
0x__	Size	cont
0x__	Size	MSB
0x__	Bank	Bank in which the preset is to be placed.
0x__	Preset	Location in the bank where the preset is to be placed.
...	Preset data	Nibbleized preset data.
0xF7	EOX	

**COMMAND 2: REQUEST PRESET BANK DUMP**

When this command is received by the PCM96 Surround, it will respond with a series of preset dumps for all presets in the bank. Blank presets will be transmitted in a special form. Only presets from User banks may be requested. Factory banks will not be transmitted.

Byte	Definition	Comments
0xF0	Sysex message	
0x06	Lexicon® Manufacturer ID	
0x__	Product ID	0x21
0x__	Device ID	
0x02	Command	Request Preset Bank Dump
0x01	Size	LSB
0x00	Size	cont
0x00	Size	cont
0x00	Size	MSB
0x__	Bank	Bank to fetch
0xF7	EOX	

# THE ALGORITHMS

## CHAMBER (SURROUND, STEREO AND MONO)

Chamber is a complex miniature-space effect resembling an echo chamber at its smaller settings and, at its larger ones, a small performance space with a more rapid build-up of reflection density than a hall. Reverberant tails are randomized.

## RANDOM DELAY (SURROUND, STEREO AND MONO)

Random Delays provide no-holds-barred control over delays. These algorithms feature one delay line per input channel. Each delay line has two outputs, called “voices.” Each voice has independent delay time (up to and over 9 seconds, plus an additional second provided by the randomizers described in the next paragraph), output level, feedback control, filtering (independent filters for feedback and output), and panning. Random Delays have the same diffusion controls as Dual Delays.

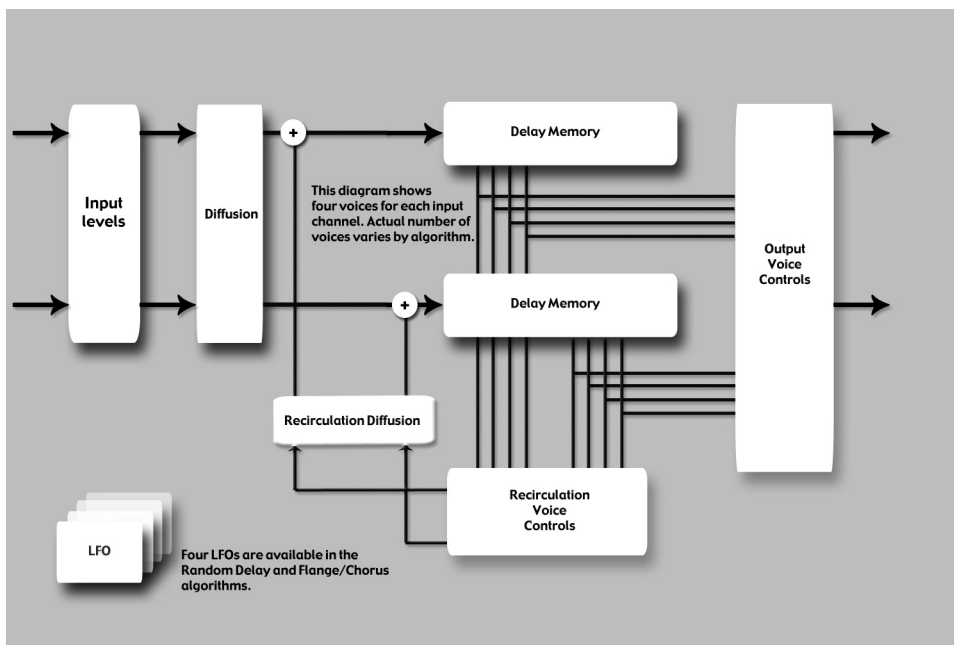

In addition to this basic voice architecture, Random Delays feature four randomizers that provide up to one second of additional delay time for each voice. Voices can be assigned to either randomizer, or to no randomizer at all.

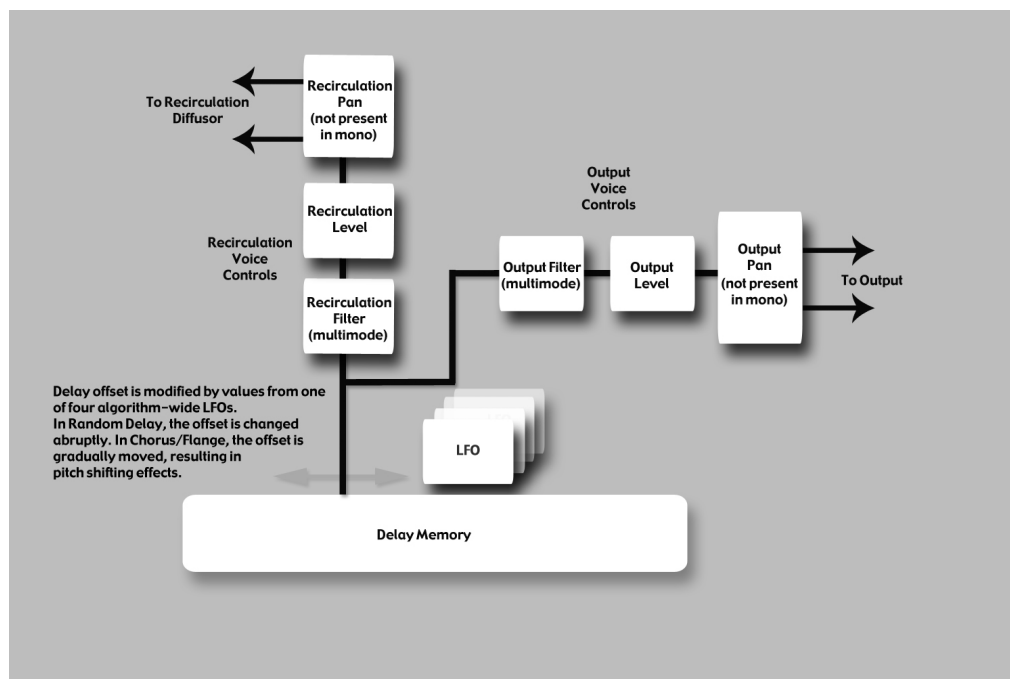

Random Delays are similar to Simple Delays, but are especially useful for:

- Multitap Tape Loops  
Feedback can be used to recirculate delays. Appropriate use of highpass and lowpass filters emulates the bandpass effects of multi-generational tape loops (hiss not included). Feedback diffusion allows emulation of azimuth misalignment – a hallmark of the sound.
- Early Reflection Modeling  
Although different in scope from Lexicon® Ambience algorithms, Random Delays can be used to place early reflections in stereo or surround fields.
- Modulated Delays  
Delay times may be modulated by signal level, LFO or random values.

### **HALL (SURROUND, STEREO AND MONO)**

A hall is the principal venue for classical ensembles, but has proven to be useful for all types of music. A hall is comparatively large, with wall-to-wall distances that are typically several tens of meters. Smaller halls may be used for smaller ensembles. The characteristic sound of a hall includes very low initial reflection density, with little reflection energy before 60-100 milliseconds. Density buildup is more gradual, because of the larger distances between reflecting surfaces. Reverberation time is somewhat longer as well. Finally, in most halls lower frequencies reverberate longer than higher frequencies.

This new hall algorithm shares these basic characteristics with Random Hall and Concert Hall, but is smoother with a more even decay. Its initial density is also lower than Random Hall so it may be a better choice when the reverberation needs to be unobtrusive.

### **RANDOM HALL (SURROUND, STEREO AND MONO)**

Random Hall is a hall effect with gradual build-up, well suited to complex sounds like orchestral music. Its reverberators change over time in controlled random ways to avoid the buildup of tinny, grainy, metallic, or other colorations. The modulation can be noticeable and is often a desirable effect.

The early reflections are user adjustable in amplitude and delay. Some skill is needed to set useful reflection patterns. The pattern can be expanded or contracted in time using the “Delay Master” control, and the overall level of the pattern can be set with the “Early Level” control.

A hall is the principal venue for classical ensembles, but has proven to be useful for all types of music. A hall is comparatively large, with wall-to-wall distances that are typically several tens of meters. Smaller halls may be used for smaller ensembles. The characteristic sound of a hall includes very low initial reflection density, with little reflection energy before 60-100 milliseconds. Density buildup is more gradual, because of the larger distances between reflecting surfaces. Reverberation time is somewhat longer as well. Finally, in most halls lower frequencies reverberate longer than higher frequencies.

One of its charms is a bit of irregularity in the decay. In some cases (very small rooms with precisely-pitched instruments), this modulation may not be the best choice. But in general, this is a time-tested reverberator.

### **PLATE (SURROUND, STEREO AND MONO)**

The Plate programs mimic the sounds of metal plates, with high initial diffusion and a relatively bright, colored sound. For this reason, they are good choices for percussion. They are designed to be heard as part of the music, mellowing and thickening the initial sound itself. The Plate sound is what many people associate with the word reverb, and it is useful for all popular music.

### **DUAL DELAY (SURROUND, STEREO AND MONO)**

Dual Delay feature two delay lines for each input channel. Each delay line has a single output or “voice.” Each voice has independent delay time (up to 2 seconds), output level, feedback control, filtering, and panning.

The feedback path includes highpass and lowpass filters. In addition to this basic voice architecture, Dual Delays feature parameters that provide expanded diffusion controls.

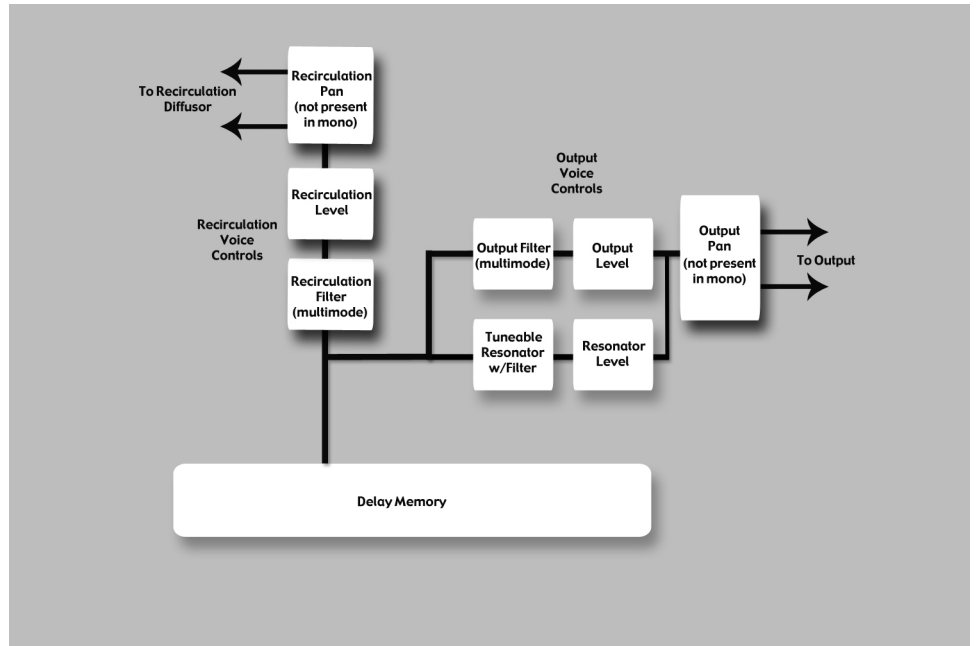

### RESONANT CHORDS (SURROUND, STEREO AND MONO)

The Resonant Chord algorithm uses impulsive energy at the inputs to excite six resonant voices (notes). The level, pitch, duration, and high-frequency cutoff of the overtones for each voice are separately controllable. Each voice can be panned independently. The voices resonate to some degree with any input, but the most effective excitation contains all frequencies, like percussion. Other instruments may give a quality of tonal ambience in which certain notes rise ethereally from the background. The output of the resonator is then fed into a stereo plate reverb effect.

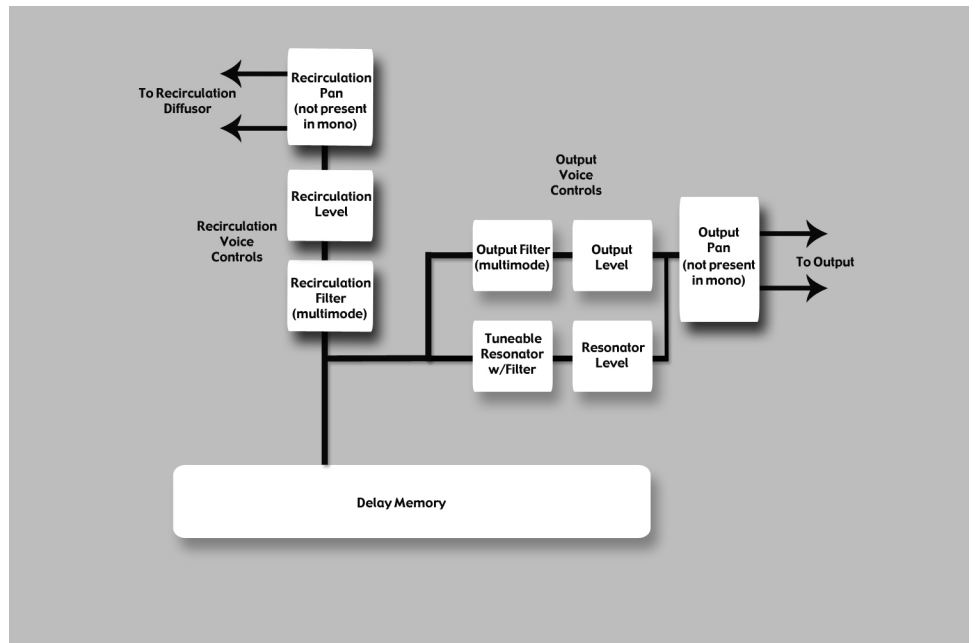

The two algorithms differ in the way pitches are assigned to the resonators. In Res1>Plate, pitches are assigned to the six voices chromatically, in a

round-robin. For example, if MIDI note numbers are used to assign pitch, the resonators will constantly be re-tuned to the pitches of the last six MIDI notes received. (This can produce an effect similar to playing a piano with the sustain pedal depressed.) In Res2>Plate, pitches are assigned to the six resonators diatonically, harmonized with the key, scale, and root of your choice. If MIDI note numbers are used to assign pitch, the resonators will constantly be re-tuned to harmonize with the incoming notes.

### **CHORUS/FLANGE (SURROUND, STEREO AND MONO)**

Chorus/Flange is quite similar to other delay algorithms in the PCM96. It has four delay voices per channel, each delay voice having over 9 seconds of delay. The delays may be independently panned and filtered. The difference is in the modulation aspect. The same LFO modulators are available as in Random Delay, but the voices react differently. In Random Delay, the voices move abruptly. In Chorus/Flange, they move very gradually, with noticeable (and desirable) pitch effects as they move. For the chorus effect, the voices move somewhat independently, yielding a thickening effect without too much filtering. For the flange effect, voices are generally paired at close intervals. As they move, a noticeable comb-filtering takes place due to cancellation. The voices are often fed back, nearly to the point of instability.

### **CONCERT HALL (SURROUND, STEREO AND MONO)**

This is a recreation of one of Lexicon<sup>®</sup>'s oldest algorithms. It was an essential part of many of the mixes of the late seventies and eighties. It is a less-dense reverb, allowing it to add lushness to a mix without stepping on the dry source material. It also has quite noticeable modulation, causing strong pitch effects at higher settings. The reverb tail has a life of its own, desirable in pop music, less so in jazz or classical applications.

### **ROOM (SURROUND, STEREO AND MONO)**

A room is similar to a reverb in that it is used to create the illusion of space. However it differs in important ways. A room is comprised of a selectable early impulse taken from actual room measurements. There are several categories of responses, including small rooms, large rooms and odd rooms (impulses from unconventional sources). There are parameters to allow adjustments to this response, including scaling and reversing the response. In many cases this is sufficient. A reverb tail can be added to the room by means of an included small reverb algorithm.

Lexicon reverbs are renowned for smooth tails and controlled frequency response. However, in many cases the earlier components are more important. This may be true for some forms of popular music and is even more true for post-production. In these cases, specific types of spaces need to be invoked for convincing dialog and effects.

### **PITCH SHIFT - MULTIVOICE**

This pitch shifter shares the attributes of all other delay algorithms – multiple voices with independent panning and EQ – and adds the ability to shift each voice by as much as an octave up or down. It may be used for chords, voice fatteners, rising/falling echos or many other effects.

The number of voices that appear in this algorithm is dependent on the type of machine it's loaded into. In the case of Quad, there will be twelve voices (3 per channel). In the case of Five Channel, there will be fifteen. The pre-

sets themselves may be loaded into either type of machine, with the appropriate number of voices appearing. Every effort is made to make the factory presets sound alike in both formats, but it is possible to may presets that work very differently, based on machine type.

### **PITCH SHIFT - STANDARD VSO**

This simple pitch shifter provides high-quality shifting by semitones and cents. In stereo or surround, this is the best choice for full music mixes or for any multichannel submixes. Shifting on all channels is linked, so that the resultant soundstage remains stable.

### **PITCH SHIFT - MULTI MONO VSO**

This shifter shifts all channels independently, making no effort to maintain multichannel coherence. It is intended for multichannel material in which the channels do not share material. It may be used in 4, 5, and 6-channel machines.

### **PITCH SHIFT - POST VSO**

This shifter shifts stereo groups independently, keeping channels within the groups coherent, but making no effort to maintain coherence between stereo groups. It is of most value in audio post, where L/R, LS/RS are perceived as stereo pairs. Center and LFE are uncorrelated.

In this algorithm, center and LFE channels (if present) are treated independently. The lowest frequency parameter does not affect shifting in these channels.

### **SIGNAL GENERATOR**

This algorithm is used to generate test signals. These signals may be used both for building presets and for testing aspects of recording studio functionality. The sweep tone generator is good both for locating bad speaker drivers and for scaring your cat.



## THE PARAMETERS

The PCM 96 contains hundreds of presets, covering just about every possible need. But you can refine and customize any preset by adjusting its **parameters**. Parameters are the building blocks within each preset that determine how it sounds and behaves.

Each **algorithm** contains a set of parameters, and a variety of those parameters (sometimes from more than one algorithm) are combined to create a preset. You can edit a machine preset's parameters via the A, B, and C knobs (which control the **Soft Row**; see page 11 for more information), or you can access parameters located in sub-menus via the Machine menu (see page 26 for more information about the Machine menu). You can edit a system preset's parameters by accessing them via the preset's sub-menus, or you can edit the parameters in the individual machine presets contained within the machine preset.

Below are all the algorithm parameters you can edit in the PCM 96. Note that sometimes parameter names are abbreviated when they appear onscreen (for example, Delay Level Master may appear as DlyLvlMaster), and they may have prefixes indicating what channel they control (for example, Level may appear as RightInLvl, or OutLvl).

To see the parameters in context, refer to the charts beginning on page 47.

### **Bandwidth**

This parameter lets you set the bandwidth of a multimode filter. Bandwidth is specified in octaves or fractions thereof.

### **Bass Boost (Room)**

This parameter is closely tied to the Bass Crossover parameter. It controls the boost (or cut) of signal below that crossover.

Depending on the type of impulse response selected, the listener may become aware of an excess or insufficiency of low frequency output. This parameter may be used to correct the frequency response.

### **Bass Crossover (BassXOver)**

The Bass Crossover parameter is closely tied to the BassRT parameter. It represents the frequency below which BassRT has an effect. Note that there are two of these parameters in the Room algorithm. One is tied to BassRT, the other is found in the Pattern settings menu and affects the BassBoost.

### **BassRT**

This parameter controls bass reverb time. It is closely associated with the Bass Crossover and MidRT parameters. BassRT is a multiple of MidRT that applies to signal below the frequency described by Bass Crossover. If BassRT is less than 1.0, then the low frequency part of the reverb tail will be shorter than the midrange part. If BassRT is greater than 1.0, then the low frequency part of the tail is longer.

### **Category (Room)**

This parameter lets you select a specific category from which a room response may be chosen. Changes here have a direct effect on the Pattern Selector parameter.

### **Chorus Depth (Concert Hall)**

This parameter controls the amount of randomization of the chorus tap. Higher values are generally preferred in order to minimize reverb coloration. Pitch effects may result and are closely tied to the Reverb Chorus Rate parameter.

### **Chorus Rate (Concert Hall)**

This parameter controls the rate at which the reverb chorus is run. Low values may cause a barely-noticeable undulation. Higher values will cause noticeable wobble in fixed-pitch instruments such as piano. It is closely tied to the Reverb Chorus Depth parameter.

### **Cross Fade Time**

This is used to control the crossfade time of the splice. In general a short crossfade is desirable, but more complex material may need longer crossfade times.

### **Definition**

Definition controls the density of some reverbs. Higher values result in lower density.

### **Delay Feedback Master**

Controls all delays in the algorithm. Each voice has its nominal feedback gain adjusted by this percentage.

### **Delay Level Master**

Controls all delays in the algorithm. Each voice has its nominal gain value adjusted by this percentage.

### **Delay Time (Echo Delay)**

Delay time defines the time offset of a delay voice in milliseconds or in fractions of tempo (quarter note, eighth note), which is defined by the tap tempo or by midi tempo. It is used in many of the algorithms, not just the delays. In all cases, it does the same thing.

### **Delay Time Master**

Controls all delays in the algorithm. Each voice has its nominal delay time adjusted by this percentage.

### **Delay Wander**

This parameter determines the amount of additional delay that the LFO process can add to a voice's offset.

### **Diffusion**

Input diffusion is the first part of processing for any signal entering a reverb or delay. It can be described as a smearing or softening of the signal and is typically used to lessen the impact of strong transients.

### **Bass Crossover (Bass XOver) (Room)**

This parameter is closely tied to the Early Bass Boost parameter. It represents the frequency below which early bass boost has an effect.

**Feedback**

This controls the amount of echo output that is fed back to the input of the echo buffer.

The actual feedback level is modified by the Master Echo Feedback parameter, if present. The master value is a percentage (0-100%) that is applied to the Echo Feedback level.

**Feedback Diffusion**

Feedback Diffusion is similar to Input Diffusion, except that it is applied to a delayed signal that is being added back into the input.

**Feedback Level**

This parameter determines the feedback level for a particular voice. It is controlled independently of the voice's output level.

**Feedback Pan**

Routes the post-filter delay voice back to the inputs of the delay lines.

**Frequency**

This parameter lets you set the cutoff frequency of the multimode filter. The audible effect of this is determined by the Type parameter.

**Front Early Level**

This parameter acts as a master control for any early signals going to the output channels. Early signals include echoes, reflections, and the room reflection patterns.

**Infinite**

This parameter captures the reverb tail as an infinite loop. This may be useful in music, where a note or chord can be extended. It is also useful in post-production for creating ambience backgrounds.

**Input Level**

Input Level controls the amount of signal admitted into the process from a single input channel.

**Input Pan**

Routes the signal from an input channel into the algorithm in such a manner as to alter its apparent location.

**Level**

This parameter acts as a master control for reverb signals going to the output channels. It is used for all reverbs.

**LFO Rate**

Set the speed of an LFO in Hz.

**LFO Waveform Type**

Set the shape of the wave the LFO will follow.

**Lowest Shift Freq**

This tells the shifter the lowest frequency that it may be required to shift. As a general rule of thumb, this should be set in the higher part of the range in order to preserve detail in the shifted material. It should be lowered if artifacts appear in the low frequencies.

### **Master Echo Delay**

Controls all echo voices in the algorithm. Each echo delay has its nominal time adjusted by this percentage.

### **Master Echo Feedback**

Controls all echo voices in the algorithm. Each echo feedback has its nominal gain adjusted by this percentage.

### **Master Reflection Delay (Reflection Time Master)**

Controls all reflection delays in the algorithm. Each reflection delay voice has its nominal delay time adjusted by this percentage.

### **MidRT**

MidRT is the mid frequency reverb time. As such, it is one of the primary controls affecting the length of the reverb tail. At low values, it models a space with absorbent walls—a signal won't bounce many times before it dissipates. At high values, the walls are flat and extremely reflective. A signal lives a long time before dying away.

The parameter most closely associated with MidRT is Size. A large room size with a small MidRT can easily have the same decay time as a small room with a large MidRT. The value that is actually displayed is an approximate reverb time based on both of those values.

### **Mix (Wet Dry Mix)**

Mix is the proportion of wet (processed) signal to dry (unprocessed) signal.

### **Output Level**

Output Level controls the amount of post-mix signal emitted onto a channel of output.

### **Pan**

Routes the post-filter delay voice across the left-right soundstage.

### **Pattern**

Selects a space available in the selected Category (see Category parameter).

### **Pitch Shift**

This parameter determines the amount of positive or negative pitch shift for the shift. Expressed as a percentage.

### **Pitch Trim**

This parameter detunes the pitch shift established by the Shift Semi or Pitch Shift parameters. Expressed as a percentage.

### **Reflection Delay (Delay Time)**

A reflection delay is a delay tap taken from one of the inputs and sent to one of the outputs. It is often called a delay voice. Depending on the algorithm,

there may be one or more reflection delays for each input channel. Some of the delays may mix their outputs to the same channel (left to left) and some may go cross-channel (left to right).

### **Reflection Gain (Level)**

Each Reflection Delay voice also has a gain value. This gain is controlled by the Reflection Gain parameter.

### **Resonance**

This parameter determines at which frequency the delay voice resonates.

### **Resonance Detune Master**

Controls detuning of all voices in the algorithm. Each voice has its nominal detune, adjusted by this percentage. Includes a built-in ducker that attenuates the delay output whenever signal is present at the input. This can be used to keep the original signal from being muddied up by delay repeats.

### **Resonance Filter Master**

Controls all voices in the algorithm. Each voice's resonator has its nominal cutoff frequency adjusted by this percentage.

### **Resonance Master**

Controls all voices in the algorithm. Each voice has its nominal resonance adjusted by this percentage.

### **Resonance Tuning Master**

Affects all voices in the algorithm. Each voice has its nominal resonance adjusted by this value. In the musical world, the tuning reference is A=440. This means that the note A (above middle C) is equivalent to 440 Hz. Changing the master tuning causes all notes to be sharp or flat.

### **Resonator Detune**

This parameter acts as an adjustment to the specified frequency for the voice's resonator. The calculation of cents yields a ratio which is used to modify the specified frequency of the voice. This parameter is modified by the Master Detune parameter.

### **Resonator Filter Freq**

This parameter controls a lowpass filter inside the resonator.

### **Resonator Frequency**

This parameter determines at which frequency the delay voice resonates. The action of this parameter is determined by the state of the Resonance Mode parameter. When a frequency is calculated for this parameter, it must then be affected by the value of the Master Tuning parameter.

### **Reverb PreDelay (Predelay)**

This is a delay that's added to the diffused signal before it enters the main part of the reverb. For all intents, it may be considered as delay that is added to the reverberated signal. It is used to temporally separate the reverb from the dry signal.

### **Reverb Spin (Spin)**

This is usually simply called spin. It controls the speed of the reverb randomizer. Spin is also connected with the Reverb Wander parameter

### **Reverb Time Hi Cut**

This parameter, also known as Hicut or RTHC is a low-pass filter in the recirculating part of the reverb. It represents a frequency above which the tail dies away more quickly. In some ways, it represents the opposite end of the scale from BassRT, and may be considered an analog of air absorption. It is also closely tied to the Hi Cut Damping parameter.

### **Reverb Wander**

This parameter (also known as just Wander), along with Reverb Spin, is used to control the reverb randomizer. It controls the maximum size of randomizer steps, and is expressed in a time value (typically milliseconds).

### **Room Size**

Room Size corresponds roughly to the length of the longest wall of a rectangular room. In a more general sense, it corresponds to the overall dimension of some mythical space. This space has a geometry that causes sound to bounce around. When the room size is small, the “walls” of this space are closer together and the resultant reflection density increases. When the room size is large, that density decreases. The most natural reverbs use room sizes that vary from about 24 meters to 45 meters or so, but there are many useful reverbs that are outside of this range.

There is a relationship between this parameter and the MidRT parameter. Please see the MidRT parameter for clarification.

### **RtHC Damping**

The damping parameter is closely tied to the RTHC parameter. It controls the strength of the hi frequency absorption and has three values: Light, Normal, and Heavy. The normal value gives filter response identical to previous Lexicon® reverbs. The other values should be self-descriptive.

### **Scale**

This parameter is used to modify the overall time of the selected early impulse. It is a multiplier that goes from 0.5x to 2.0x. The actual time of the responses varies from response to response. The Early Scale parameter simply scales that amount of time. It's fair to describe this a “rubber-banding” the impulse response.

### **Selected LFO**

This parameter determines which of the available LFOs may be used to control a voice. The voice may use the LFO output or the inverted LFO output.

### **Shape (Early Shape)**

The Shape parameter is closely tied to the Spread parameter. Shape controls how energy is injected into the reverberator. A low value means that sound enters the reverb at the beginning of the spread window. A high value means that most sound moves into the reverb at the end of the spread window. A value somewhere in the middle means that sound enters the reverb evenly across the spread window.

**Tip:** Shape will not have this effect if spread is at its minimum value. But even then, it can make a difference. In this case, it affects reverb timbre and density. Higher values of shape will be both darker and denser, although the effect is subtle.

### **Shelf**

This parameter effects all filter types. It allows a certain amount of unfiltered audio to be combined with the filtered audio. This effectively lowers the effect of the filter. Another way of looking at it is that it lessens the normal filter slope of 12 dB per octave. Unlike the traditional biquad filter, the shelf is effective for all filter forms.

### **Shift Semi**

This parameter determines the amount of positive or negative pitch shift for the shift. Expressed in semitones.

### **Signal Event Freq**

Changes the rate of discreet signals from the signal generator. This only has an effect when the signal type is set to sweep tones or pink click.

### **Signal Frequency**

Changes the frequency of the signal generator sine wave. This only has an effect when the signal type is set to sine wave.

### **Signal Type**

Selects the type of signal to be created by the signal generator. The types of signal are:

- Sine Wave — When this is selected the signal frequency parameter is used to control frequency.
- Sweep Up — 20Hz to 20KHz sweep. When this is selected the signal rate parameter is used to control rate.
- Sweep Down — 20Khz to 20Hz sweep. When this is selected the signal rate parameter is used to control rate.
- Pink Click — Broadband impulse. When this is selected the signal rate parameter is used to control rate.
- White Noise (correlated) — sends identical white noise to all outputs
- White Noise (decorrelated) — sends decorrelated white noise to all outputs.
- Pink Noise (correlated) — sends identical pink noise to all outputs
- Pink Noise (decorrelated) — sends decorrelated pink noise to all outputs.

### **Smart Shift**

This tells the shifter to use smart (content-based) pitch shift or blind shift. In most cases, 'smart' is the better choice.

### **Spread (Early Spread)**

The spread parameter is closely tied to the Shape parameter. Spread is a window of time during which a signal is injected into the reverb. Shape controls just how the signal is injected during this window.

### **Tail Width**

This parameter is present in all stereo reverbs and rooms. The reverb tail (all

components of the reverb except for early reflections, etc.) is passed through a simple 2x2 matrix. This provides an encoding of the tail that dramatically changes its spatial characteristics. The tail can be changed to feel narrower (even down to mono) or wider than normal stereo. There are values for the parameter to encode the tail in such a way that it decodes into surround channels.

The parameter operates in the range of 0 to 360 degrees, with an incremental change of 1 degree. The matrix uses Sine/Cosine rules so that power distribution remains constant. This may be acceptable—even highly desirable—but the mix engineer must fully understand the process and its implications.

This is a powerful tool for audio whose release format is two-channel. It is not useful in any other format. Formats include compact disc and radio/television broadcast. Some of these effects are clear and noticeable without any sort of decoder. Many are even more dramatic when a decoder is in place, such as in a home theater.

### **Tap Slope**

This is an extremely subtle parameter and is useful in only a couple of cases:

- For halls and reverbs with relatively long reverb times, the slope should be slightly positive (0.2 or so). For rooms with very short reverb times, the slope should be slightly negative (-0.2 or so).
- Using a reverb to create a gate effect or to create a pseudo-room sound. MidRT should be at 0. Spread should be fairly high. Shape should be fairly high. Size should be fairly high. TapSlope should be in the range of (0.5 to 1.0). Play with spread, shape and size to vary the effect.

### **Type**

This parameter lets you configure a filter as any of 4 basic types, in order:

- Lowpass
- Highpass
- Bandpass
- Notch (Band-reject)

The filter provides a subset of filter types available to a Biquad filter.

### **Wet Dry Mix**

Wet Dry Mix is the proportion of wet (processed) signal to dry (unprocessed) signal.







# PCM96 SURROUND SPECIFICATIONS

## ANALOG INPUTS

Connectors	One 25-pin Dsub female connector
Impedance	20K Ohm, balanced
Level (for 0dBFS)	+4dBu mode: +20dBu -10dBV mode: 8.2dBu
Freq Response @96K	20Hz - 22kHz, $\pm 15$ dB 20Hz - 46kHz $\pm 5$ dB
A/D Dyn Range	A/D Conversion 24 bits 112dB unweighted, 115dB A-weighted
THD	<0.002% 20 → 20kHz @ +4dBu
Crosstalk @ 1Khz	<-75dB at 20 → 20k with a +20dBu input signal

## ANALOG OUTPUT

Connectors	One 25-pin Dsub female connector
Impedance	30 Ohm, electronically balanced
Level (at 0dBFS)	+4dBu mode: +20dBu -10dBV mode: 8.2dBu
Freq Response @96K	20Hz - 22kHz, $\pm 15$ dB 20Hz - 46kHz $\pm 5$ dB
D/A Conversion	24 bits
D/A Dyn Range	112dB unweighted, 115dB A-weighted
THD	<0.002% 20Hz - 20kHz at +4dBu
Crosstalk @ 1kHz	<-75dB at 20Hz - 20kHz with a +20dBu input signal

## DIGITAL AUDIO IO

Connectors	One 25-pin Dsub female connector Two FireWire™ Ports
Format	AES/EBU/FireWire (400Mb)
Word Size	24 bits

## SAMPLE RATES

Internal	44.1kHz/48kHz/88.2kHz/96kHz
Accuracy	within $\pm 50$ ppm
External	44.1kHz/48kHz/88.2kHz/96kHz
Lock Range	$\pm 2\%$ of nominal

## PROPAGATION DELAYS (MILLISECONDS)

	44.1 kHz	48 kHz	88.2 kHz	96 kHz
A/A	1.64	1.51	1.28	1.18
D/D	1.23	1.12	1.15	1.07

## SYNCHRONIZATION

TTL Word Clock Input *	75 Ohm, BNC, externally terminated to allow cascade
------------------------	---

\*Falling edge marks start of frame

**CLOCK JITTER**

Intrinsic	Exceeds AES3 Amendment 1
Jitter Gain	Exceeds AES3 Amendment 1

**CONTROL INTERFACES**

MIDI **	In/Out/Thru
---------	-------------

\*\*supports program change

**ALGORITHMS**

Chamber	Surround, Stereo and Mono
Random Delay	Surround, Stereo and Mono
Random Hall	Surround, Stereo and Mono
Plate	Surround, Stereo and Mono
Dual Delay	Surround, Stereo and Mono
Resonant Chords	Surround, Stereo and Mono
Chorus/Flange	Surround, Stereo and Mono
Concert Hall	Surround, Stereo and Mono
Room	Surround, Stereo and Mono
Hall	Surround, Stereo and Mono
Pitch Shift	
Signal Generator	

**Storage Media**

Type I Compact Flash  
Can hold up to 2048 user presets

**MACHINE CONFIGURATIONS****44.1K → 96K**

Single Stereo (Mono In)  
Single Stereo  
Dual Stereo (Mono In)  
Dual Stereo  
Cascade Stereo  
Dual Mono  
Quad Mono  
Cascade Mono  
Dual Mono + Single Stereo  
Cascade Mono to Stereo  
Single Two In Four Out  
Single Four In Four Out  
Single Two In Five Out  
Single Five In Five Out  
Single Six In Six Out

**INTERNAL STORAGE**

Internal non-volatile Flash. Can hold 1024 user presets.

**POWER**

Requirements	100-120 / 220-240 VAC 50-60Hz, 26W max
Connector	3-pin IEC

**DIMENSIONS**

Rack Units 1U  
Size 19.0" W x 1.75" H x 16" D  
(483mm x 44.5mm x 317.5mm)

Weight 14.25 lbs

**REGULATORY APPROVALS**

FCC Class A  
CE EN55103-1, EN55103-2  
UL UL1419  
cUL C22.2  
TUV EN60065

**ENVIRONMENT**

Operating 15° to 35° C  
Storage -30 to 70 °C  
Humidity 75% relative humidity max

**RECOMMENDED CABLES**

dB25 Analog Input Hosa: DTF-803  
dB25 Analog Output Hosa: DTM-803  
dB25 AES I/O Digidesign: DigiSnake Cable  
DB25 – XLR MtF AES/EBU  
snake, DB25 to 4 XLRM  
(output) and 4 XLRF (input),  
Model # MH097

**MIDI IMPLEMENTATION CHART**

Function		Transmitted	Recognized	Remarks
Basic Channel	Default	X	1-16	
	Changed	X	X	
Mode	Default	X	N/A	
	Messages	X	X	
	Altered	X	X	
Note Number	True Voice	X	X	
Velocity	Note ON	X	X	
	Note OFF	X	X	
After Touch	Keys	X	X	
	Channel	X	X	
Pitch Bend		X	X	
Control Change		OX 32 OX 48-55	OX 32 OX 48-55	Bank Change
Program Change		OX 1-127	OX 0-127	
Bank Select		O	O	
System Exclusive		Device ID	Device Inquiry	Device ID
System Common	Song Position	X	X	
	Song Select	X	X	
	Tune Request	X	X	
System Real Time	Clock	X	X	
	Commands	X	X	
Aux Messages	Local ON/OFF	X	X	
	All Notes OFF	X	X	
	Active Sensing	X	X	
	System Reset	X	X	
Notes				

Mode 1: OMNI ON, POLY  
Mode 3: OMNI OFF, POLY

Mode 2: OMNI ON, MONO  
Mode 4: OMNI OFF, MONO

O : Yes    OX : Selectable  
X : No





Harman Music Group  
8760 South Sandy Parkway | Sandy, Utah 84070  
U.S.A.  
Phone: (801)-568-7660 | Fax: (801)-568-7662  
PCM96 Surround

Questions or comments?  
Email us at: [customer@lexiconpro.com](mailto:customer@lexiconpro.com)  
or visit us online at [www.lexiconpro.com](http://www.lexiconpro.com)