

# **the t.mix**

mix 502, mix 802,  
mix 1202FX

mixer

Musikhaus Thomann  
Thomann GmbH  
Hans-Thomann-Straße 1  
96138 Burgebrach  
Germany  
Telephone: +49 (0) 9546 9223-0  
E-mail: [info@thomann.de](mailto:info@thomann.de)  
Internet: [www.thomann.de](http://www.thomann.de)

08.02.2019, ID: 370662, 370664, 370666 (V3)

# Table of contents

<b>1</b>	<b>General information</b> .....	<b>4</b>
	1.1 Further information.....	5
	1.2 Notational conventions.....	6
	1.3 Symbols and signal words.....	6
<b>2</b>	<b>Safety instructions</b> .....	<b>8</b>
<b>3</b>	<b>Features</b> .....	<b>12</b>
<b>4</b>	<b>Installation and starting up</b> .....	<b>15</b>
<b>5</b>	<b>Connections and controls</b> .....	<b>16</b>
<b>6</b>	<b>Technical specifications</b> .....	<b>40</b>
<b>7</b>	<b>Plug and connection assignment</b> .....	<b>45</b>
<b>8</b>	<b>Protecting the environment</b> .....	<b>49</b>

# 1 General information

This user manual contains important information on the safe operation of the device. Read and follow all safety notes and all instructions. Save this manual for future reference. Make sure that it is available to all persons using this device. If you sell the device to another user, be sure that they also receive this manual.

Our products and user manuals are subject to a process of continuous development. We therefore reserve the right to make changes without notice. Please refer to the latest version of the user manual which is ready for download under [www.thomann.de](http://www.thomann.de).

## 1.1 Further information

On our website ([www.thomann.de](http://www.thomann.de)) you will find lots of further information and details on the following points:

Download	This manual is also available as PDF file for you to download.
Keyword search	Use the search function in the electronic version to find the topics of interest for you quickly.
Online guides	Our online guides provide detailed information on technical basics and terms.
Personal consultation	For personal consultation please contact our technical hotline.
Service	If you have any problems with the device the customer service will gladly assist you.

## 1.2 Notational conventions

This manual uses the following notational conventions:

### Letterings

The letterings for connectors and controls are marked by square brackets and italics.

**Examples:** *[VOLUME]* control, *[Mono]* button.

## 1.3 Symbols and signal words

In this section you will find an overview of the meaning of symbols and signal words that are used in this manual.

Signal word	Meaning
<b>DANGER!</b>	This combination of symbol and signal word indicates an immediate dangerous situation that will result in death or serious injury if it is not avoided.
<b>CAUTION!</b>	This combination of symbol and signal word indicates a possible dangerous situation that can result in minor injury if it is not avoided.
<b>NOTICE!</b>	This combination of symbol and signal word indicates a possible dangerous situation that can result in material and environmental damage if it is not avoided.
Warning signs	Type of danger
	Warning – high-voltage.
	Warning – danger zone.

## 2 Safety instructions

### **Intended use**

This device is intended to be used for amplification, mixing and playback of signals from musical instruments and microphones. Use the device only as described in this user manual. Any other use or use under other operating conditions is considered to be improper and may result in personal injury or property damage. No liability will be assumed for damages resulting from improper use.

This device may be used only by persons with sufficient physical, sensorial, and intellectual abilities and having corresponding knowledge and experience. Other persons may use this device only if they are supervised or instructed by a person who is responsible for their safety.



**Safety**



**DANGER!**

**Danger for children**

Ensure that plastic bags, packaging, etc. are disposed of properly and are not within reach of babies and young children. Choking hazard!

Ensure that children do not detach any small parts (e.g. knobs or the like) from the unit. They could swallow the pieces and choke!

Never let children unattended use electrical devices.



**DANGER!**

**Electric shock caused by high voltages inside**

Within the device there are areas where high voltages may be present. Never remove any covers.

There are no user-serviceable parts inside.

Do not use the device if covers, protectors or optical components are missing or damaged.



**CAUTION!**

**Possible hearing damage**

With loudspeakers or headphones connected, the device can produce volume levels that may cause temporary or permanent hearing impairment.

Do not operate the device permanently at a high volume level. Decrease the volume level immediately if you experience ringing in your ears or hearing impairment.



**NOTICE!**

**Risk of fire**

Do not block areas of ventilation. Do not install the device near any direct heat source. Keep the device away from naked flames.



**NOTICE!**

**Operating conditions**

This device has been designed for indoor use only. To prevent damage, never expose the device to any liquid or moisture. Avoid direct sunlight, heavy dirt, and strong vibrations.



**NOTICE!**

**External power supply**

The device is powered by an external power supply. Before connecting the external power supply, ensure that the input voltage (AC outlet) matches the voltage rating of the device and that the AC outlet is protected by a residual current circuit breaker. Failure to do so could result in damage to the device and possibly the user.

Unplug the external power supply before electrical storms occur and when the device is unused for long periods of time to reduce the risk of electric shock or fire.

### 3 Features

#### mix 502

- 5-channel mixer
- 1 × mono input (MIC, line)
- 2 × stereo input (line)
- 1 × master output (stereo)
- 1 × stereo RCA audio input
- 1 × stereo RCA audio output
- 2-band equalizer (mono channel)
- Pan control
- 48 V phantom power
- Headphones output separately adjustable
- Suitable power supply included

**mix 802**

- 8-channel mixer
- 4 × mono input (MIC, line)
- 2 × stereo input (line)
- 1 × master output (stereo)
- 1 × control room output
- 1 × stereo RCA audio input
- 1 × stereo RCA audio output
- 3-band equalizer
- Pan control
- 48 V phantom power
- Headphones output separately adjustable
- Suitable power supply included

### **mix 1202fx**

- 12-channel FX mixer
- 4 × mono input (MIC, line)
- 4 × stereo input (line)
- 1 × master output (stereo)
- 1 × control room output
- 1 × stereo RCA audio input
- 1 × stereo RCA audio output
- 3-band equalizer
- Pan control
- 48 V phantom power
- Headphones output separately adjustable
- Suitable power supply included

## 4 Installation and starting up

Unpack and check carefully there is no transportation damage before using the unit. Keep the equipment packaging. To fully protect the product against vibration, dust and moisture during transportation or storage use the original packaging or your own packaging material suitable for transport or storage, respectively.

Only use the supplied power adapter. The connector for the power supply is located on the rear panel.

The device has no main switch. Supply voltage is available as soon as you connect the device to the power grid via the power supply.

Before connecting the supply voltage and before connecting or disconnecting audio cables, set all volume controls of the unit to zero to avoid damage to the connected speakers and devices.

## 5 Connections and controls

### mix 502 – overview

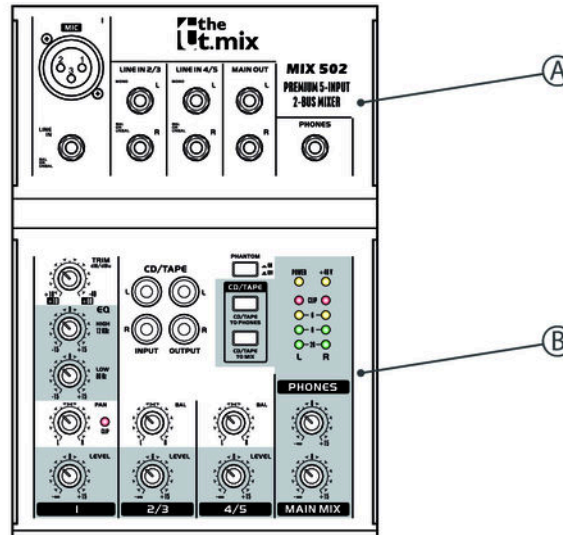



mix 502 – partial view A

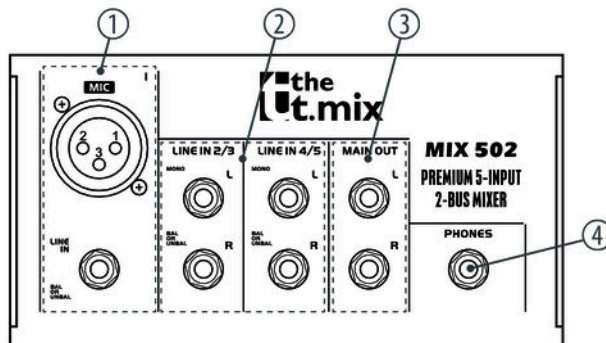

mix 502, mix 802, mix 1202FX

1	<p><i>[MIC]   [LINE IN]</i></p> <p>Mono input channel with XLR input socket <i>[MIC]</i> and 1/4" phone socket <i>[LINE IN]</i>.</p>
2	<p><i>[LINE IN X/X]</i></p> <p>Stereo input channels, each with 2 × 1/4" phone sockets (L/R) to connect a stereo source (keyboard, drum module, etc.) or an instrument (guitar, bass). Always use the input L (mono jack) for mono operation on these channels.</p>
3	<p><i>[MAIN OUT]</i></p> <p>Mono output with 2 × 1/4" phone sockets (unbalanced) for connecting a PA system, a PC or powered speakers. The main signal is present with 0 dBu on this output, volume is controlled by rotary control <i>[MAIN MIX]</i>.</p>
4	<p><i>[PHONES]</i></p> <p>Headphones output, designed as 1/4" phone socket.</p>

mix 502 – partial view B

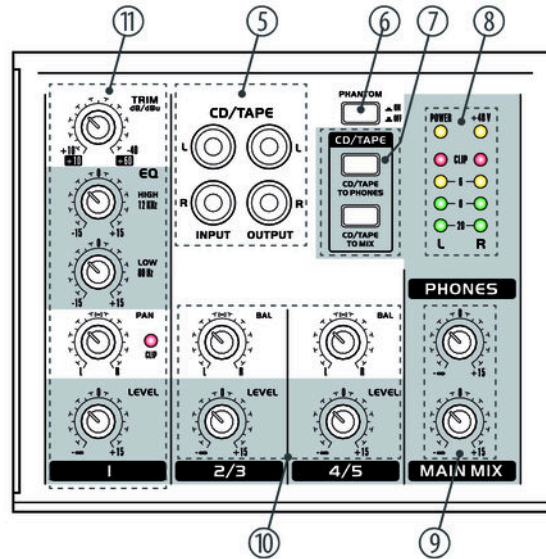

mix 502, mix 802, mix 1202FX

5 *[CD/TAPE INPUT]*

Stereo RCA input sockets for feeding the signal from a CD or MP3 player.

*[CD/TAPE OUTPUT]*

Stereo RCA output sockets for connecting an external recording device.

6 *[PHANTOM]*

Switch to enable 48 V phantom power for condenser microphones connected to the XLR socket of the mono input channel. When pressed, phantom power is present and the LED *[+48V]* lights yellow.

Disable 48 V phantom power before connecting a microphone. Set all volume controls of the device to zero before enabling 48 V phantom power.

7 *[CD/TAPE TO PHONES]*

Press *[CD/TAPE TO PHONES]* to route the *[CD/TAPE INPUT]* input signal to the headphones output.

*[CD/TAPE TO MIX]*

Press *[CD/TAPE TO MIX]* to route the *[CD/TAPE INPUT]* input signal to the main mix. Volume is then controlled via rotary control *[MAIN MIX]*.

## 8 Indicator LEDs:

*[POWER]*: lights yellow when operating voltage is present.

*[+48V]*: lights yellow when 48 V phantom power is present.

*[CLIP]*: lights red when the output signal is clipping. The associated LED chain shows the output signal level.

9 *[PHONES]* | *[MAIN MIX]*

Rotary controls for adjusting the volume of the headphones output *[PHONES]* and the output signal *[MAIN MIX]* of the device.

The headphones output and *[MAIN MIX]* can only be adjusted together.

### 10 Stereo channels 5 ... 8

*[BAL]*: Rotary volume for stereo balance setting.

*[LEVEL]*: Rotary control for setting the output signal volume.

### 11 Mono channel 1

*[TRIM]*: Rotary control to adjust the gain.

*[EQ]*: Rotary controls for adjusting treble and bass.

*[PAN]*: Rotary control to position the signal within the stereo panorama.

*[LEVEL]*: Rotary control for adjusting the output signal volume.

mix 802 – overview

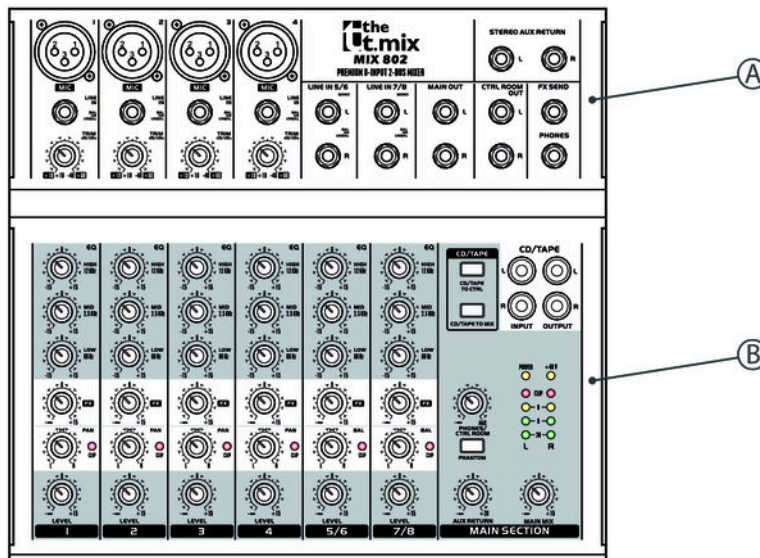

mix 502, mix 802, mix 1202FX

mix 802 – partial view A

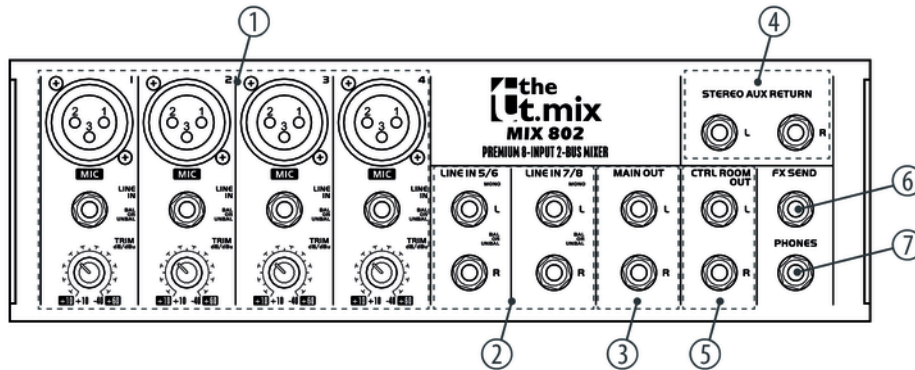



1	<p><i>[MIC]   [LINE IN]</i></p> <p>Mono input channels with XLR input socket <i>[MIC]</i> and 1/4" phone socket <i>[LINE IN]</i> to connect a microphone, with rotary control <i>[TRIM]</i> for channel gain.</p>
2	<p><i>[LINE IN X/X]</i></p> <p>Stereo input channels, each with 2 × 1/4" phone sockets (L/R) to connect a stereo source (keyboard, drum module, etc.) or an instrument (guitar, bass). Always use the input L (mono jack) for mono operation on these channels.</p>
3	<p><i>[MAIN OUT]</i></p> <p>Mono output with 2 × 1/4" phone sockets (unbalanced) for connecting a PA system, a PC or powered speakers. The main signal is present with 0 dBu on this output, volume is controlled by rotary control <i>[MAIN MIX]</i>.</p>
4	<p><i>[STEREO AUX RETURN]</i></p> <p>1/4" input sockets for the processed signal of a looped-in effects device.</p>
5	<p><i>[CTRL ROOM OUT]</i></p> <p>1/4" output sockets for connecting stage or near-field monitors.</p>

- |   |  |
|---|--|
| 6 | <i>[FX SEND]</i><br>1/4" output socket to feed the signal to an external effects device. |
| 7 | <i>[PHONES]</i><br>Headphones output, designed as 1/4" phone socket.                     |

mix 802 – partial view B

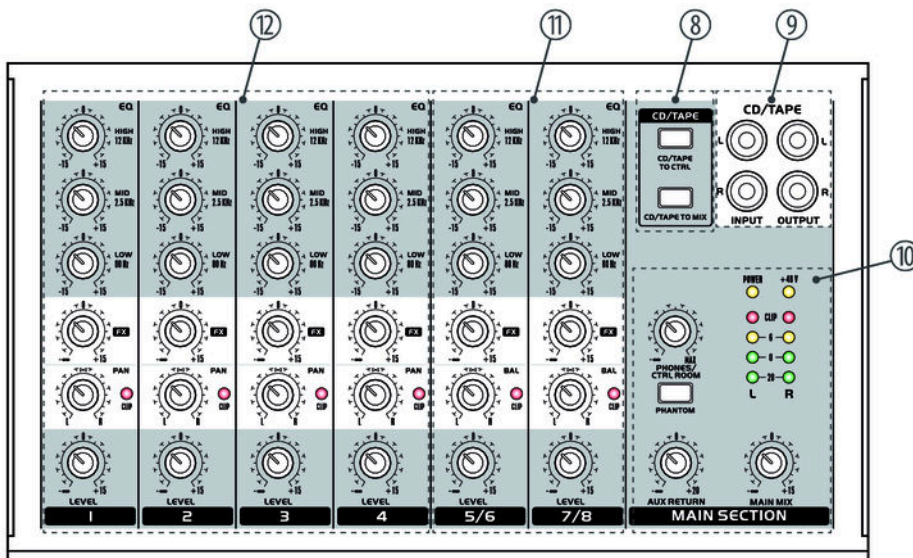

mix 502, mix 802, mix 1202FX

8 *[CD/TAPE TO PHONES]*

Press *[CD/TAPE TO PHONES]* to route the *[CD/TAPE INPUT]* input signal to the headphones output. Then the signal is not present on the main output.

*[CD/TAPE TO MIX]*

Press *[CD/TAPE TO MIX]* to route the *[CD/TAPE INPUT]* input signal to the main mix. Volume is then controlled via rotary control *[MAIN MIX]*.

9 *[CD/TAPE INPUT]*

Stereo RCA input sockets for feeding the signal from a CD or MP3 player.

*[CD/TAPE OUTPUT]*

Stereo RCA output sockets for connecting an external recording device.

10 *[MAIN SECTION]*

Indicator LEDs:

*[POWER]*: lights yellow when operating voltage is present.

*[+48V]*: lights yellow when 48 V phantom power is present.

*[CLIP]*: lights red when the output signal is clipping. The associated LED chain shows the output signal level.

*[MAIN MIX]*: Rotary control for adjusting the volume of the output signal.

*[PHONES/CTRL ROOM]*: Rotary control for adjusting the volume of the headphones output or the connected stage or near-field monitors, respectively.

*[PHANTOM]*: Switch to enable 48 V phantom power for condenser microphones connected to the XLR socket of a mono input channel. When pressed, phantom power is present and the LED [+48V] lights yellow.

Disable 48 V phantom power before connecting a microphone. Set all volume controls of the device to zero before enabling 48 V phantom power.

*[AUX FX RETURN]*: Rotary control to adjust the effect volume of the overall volume.

### 11 Mono channels 1 ... 4

*[EQ]*: Rotary controls for adjusting treble, mids and bass.

*[FX]*: Rotary control to adjust the channel effects ratio to the overall volume.

*[PAN]*: Rotary control to position the signal within the stereo panorama.

*[LEVEL]*: Rotary control for adjusting the output signal volume.

### 12 Stereo channels 5 ... 8

*[EQ]*: Rotary controls for adjusting treble, mids and bass.

*[FX]*: Rotary control to adjust the channel effects ratio to the overall volume.

*[PAN]*: Rotary control to position the signal within the stereo panorama.

*[LEVEL]*: Rotary control for adjusting the output signal volume.

mix 1202FX – overview

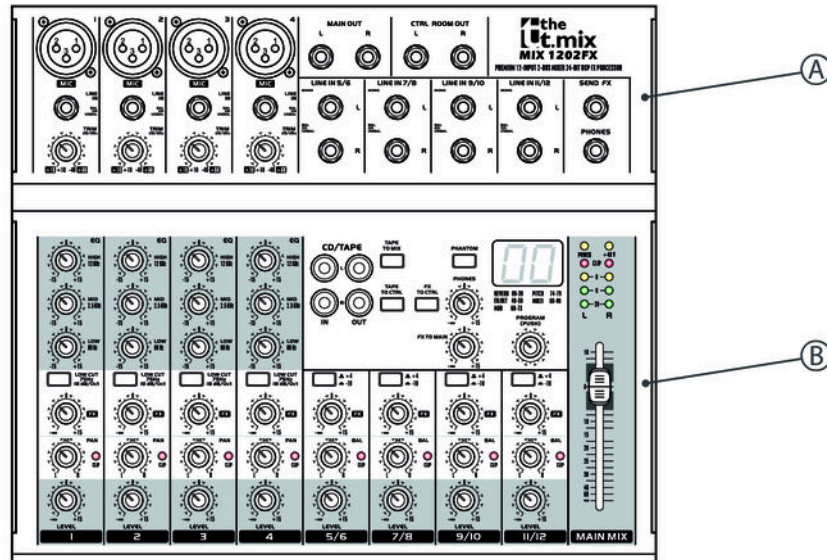

mix 502, mix 802, mix 1202FX

**mix 1202FX – partial view A**

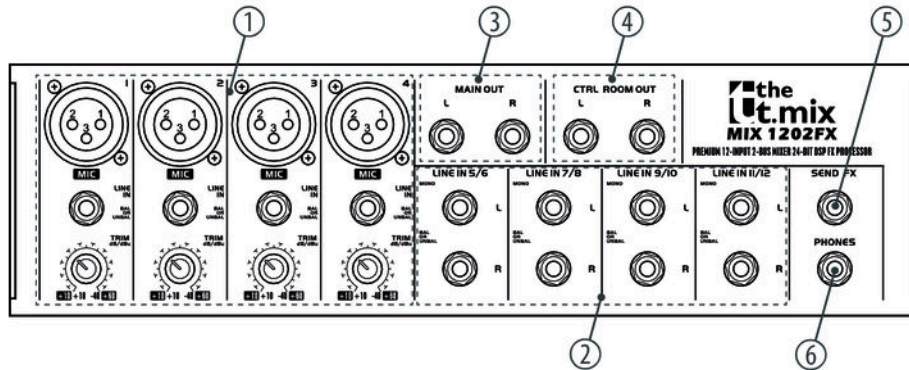



1	<p><i>[MIC]   [LINE IN]</i></p> <p>Mono input channels with XLR input socket <i>[MIC]</i> and 1/4" phone socket <i>[LINE IN]</i> to connect a microphone, with rotary control <i>[TRIM]</i> for channel gain.</p>
2	<p><i>[LINE IN X/X]</i></p> <p>Stereo input channels, each with 2 × 1/4" phone sockets (L/R) to connect a stereo source (keyboard, drum module, etc.) or an instrument (guitar, bass). Always use the input L (mono jack) for mono operation on these channels.</p>
3	<p><i>[MAIN OUT]</i></p> <p>Mono output with 2 × 1/4" phone sockets (unbalanced) for connecting a PA system, a PC or powered speakers. The main signal is present with 0 dBu on this output, volume is controlled by the main fader.</p>
4	<p><i>[CTRL ROOM OUT]</i></p> <p>1/4" output sockets for connecting stage or near-field monitors.</p>
5	<p><i>[FX SEND]</i></p> <p>1/4" output socket to connect an external effects device.</p>
6	<p><i>[PHONES]</i></p> <p>Headphones output, designed as 1/4" phone socket.</p>

mix 1202FX – partial view B

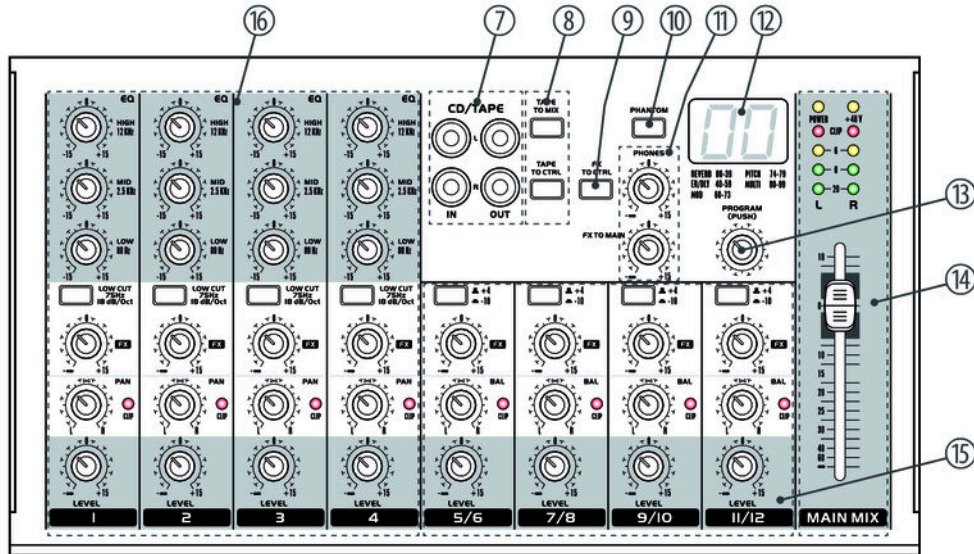

- 7 *[CD/TAPE INPUT]*  
Stereo RCA input sockets for feeding the signal from a CD or MP3 player.
- [CD/TAPE OUTPUT]*  
Stereo RCA output sockets for connecting an external recording device.
- 8 *[CD/TAPE TO PHONES]*  
Press *[CD/TAPE TO PHONES]* to route the *[CD/TAPE INPUT]* input signal to the headphones output. Then the signal is not present on the main output.
- [CD/TAPE TO MIX]*  
Press *[CD/TAPE TO MIX]* to route the *[CD/TAPE INPUT]* input signal to the main mix. Volume is then controlled via rotary control *[MAIN MIX]*.
- 9 *[FX TO CTRL]*  
Press *[FX TO CTRL]* to route the processed signal to the stage or near-field monitors.

10	<p><i>[PHANTOM]</i></p> <p>Switch to enable 48 V phantom power for condenser microphones connected to the XLR socket of a mono input channel. When pressed, phantom power is present and the LED <i>[+48V]</i> lights yellow.</p> <p>Disable 48 V phantom power before connecting a microphone. Set all volume controls of the device to zero before enabling 48 V phantom power.</p>
11	<p><i>[PHONES]</i>: Rotary control for adjusting the volume of the headphones output.</p> <p><i>[FX TO MAIN]</i>: Rotary control to adjust the effect volume of the overall volume.</p>
12	Display to indicate the selected effect.
13	<p><i>[PROGRAM (PUSH)]</i></p> <p>Effects selector switch. The number of the selected effect is flashing in the display. Press the selector switch to confirm the selection and to enable the effect.</p>
14	<p><i>[MAIN MIX]</i></p> <p>Indicator LEDs:</p> <p><i>[POWER]</i>: lights yellow when operating voltage is present.</p> <p><i>[+48V]</i>: lights yellow when 48 V phantom power is present.</p> <p><i>[CLIP]</i>: lights red when the output signal is clipping. The associated LED chain shows the output signal level.</p>

	Fader for adjusting the volume of the output signal.
15	Stereo channels 5 ... 8 <i>[FX]</i> : Rotary control to adjust the channel effects ratio to the overall volume. <i>[BAL]</i> : Rotary control to position the signal within the stereo panorama. <i>[LEVEL]</i> : Rotary control for adjusting the output signal volume. <i>[+4/-10]</i> : Toggle switch for input sensitivity +4 dBu (studio level) or -10 dBu (home recording level).
16	Mono channels 1 ... 4 <i>[EQ]</i> : Rotary controls for adjusting treble, mids and bass. <i>[FX]</i> : Rotary control to adjust the channel effects ratio to the overall volume. <i>[PAN]</i> : Rotary control to position the signal within the stereo panorama. <i>[LEVEL]</i> : Rotary control for adjusting the output signal volume. <i>[LOW CUT]</i> : Switch to enable the high pass filter.

Connection pattern – club gig

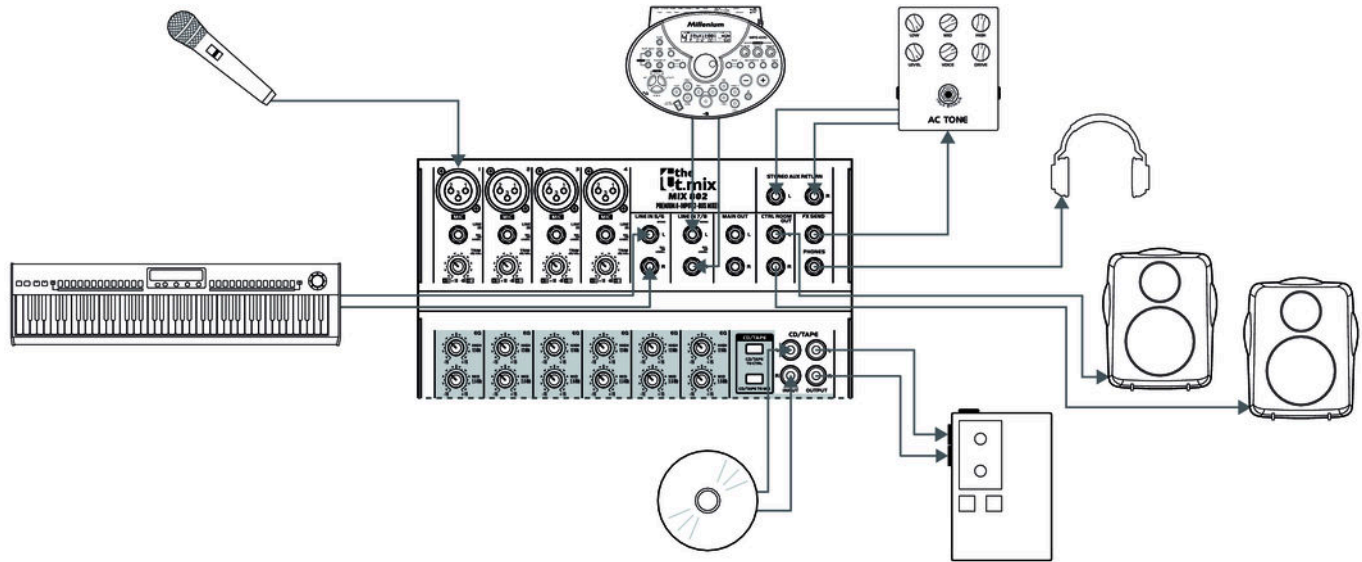

Connection pattern – PC home recording

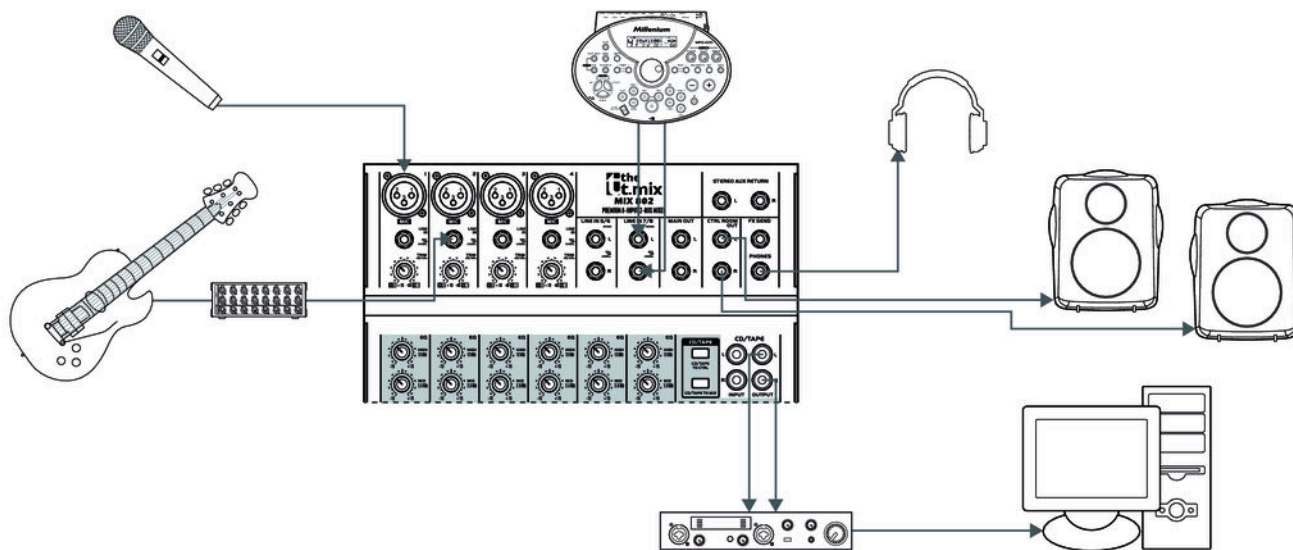

mix 502, mix 802, mix 1202FX

## 6 Technical specifications

Input connections	Mono	Type	1/4" jack socket, balanced
		Level	max. +12 dBu @ +10 dB Gain
		Impedance	2.6 kΩ
		Signal gain	+10 ... +60 dB
	Line	Type	1/4" jack socket, balanced
		Level	max. +22 dBu @ +0 dB Gain
		Impedance	20 kΩ, balanced 10 kΩ, unbalanced
		Signal gain	-10 ... +40 dB
	Stereo	Type	Pair of RCA sockets
		Level	max. +22 dBu
		Impedance	20 kΩ



	Microphone	Type	XLR chassis socket, 3-pin
Output connections	Main	Type	1/4" jack socket (unbalanced)
		Level	max. +28 dBu
		Impedance	120 $\Omega$ , unbalanced
	Aux	Type	1/4" jack socket
		Level	max. +22 dBu
		Impedance	20 k $\Omega$
	CTRL	Type	1/4" jack socket
		Level	max. +22 dBu
		Impedance	120 $\Omega$
	Phones	Level	max. +25 dBu
Frequency range	Mono		<10 Hz ... 150 kHz (-1 dB)
			<10 Hz ... 200 kHz (-3 dB)
	Line		<10 Hz ... 90 kHz (0 dB / -1 dB)

mix 502, mix 802, mix 1202FX

## Technical specifications

---

		<10 Hz ... 160 kHz (0 dB / -3 dB)
	Stereo	<10 Hz ... 90 kHz (0 dB / -1 dB)
		<10 Hz ... 160 kHz (0 dB / -3 dB)
Signal-to-noise ratio		110 dB / 112 dB, A-weighted
Total harmonic distortion (THD)		0.005 % / 0.004 %, A-weighted
Equalizer	Range HIGH	12 kHz / 15 dB
	Range MID	2.5 kHz / 15 dB
	Range LOW	80 Hz / 15 dB
Phantom power		48 V
Power consumption	t.mix 502	13 W
	t.mix 802	17 W
	t.mix 1202FX	23 W
Supply voltage		230 V ~ 50 Hz
Dimensions (W × H × D)	t.mix 502	125 mm × 50 mm × 195 mm

	t.mix 802	245 mm × 60 mm × 240 mm
	t.mix 1202FX	270 mm × 60 mm × 240 mm
Weight	t.mix 502	0.7 kg
	t.mix 802	1.5 kg
	t.mix 1202FX	1.7 kg
Ambient conditions	Temperature range	0 °C...40 °C
	Relative humidity	50 %, non condensing

mix 502, mix 802, mix 1202FX

### Further information

	<b>t.mix mix 502</b>	<b>t.mix mix 802</b>	<b>t.mix mix 1202FX</b>
Built-in effects unit	No	No	Yes
Suitable for 19"	No	No	No
Microphone channels	1	4	4
Number of stereo inputs	2	2	4
Number of buses	0	1 (post)	1 (post)
Phantom powering	Yes	Yes	Yes
Built-in power supply	No	No	No
Parametric	No	No	No
Digital interface	No	No	No

## 7 Plug and connection assignment

### Introduction

This chapter will help you select the right cables and plugs to connect your valuable equipment in such a way that a perfect sound experience is ensured.

Please note these advices, because especially in 'Sound & Light' caution is indicated: Even if a plug fits into the socket, an incorrect connection may result in a destroyed power amp, a short circuit or 'just' in poor transmission quality!

### Balanced and unbalanced transmission

Unbalanced transmission is mainly used in semi-professional environment and in hifi use. Instrument cables with two conductors (one core plus shielding) are typical representatives of the unbalanced transmission. One conductor is ground and shielding while the signal is transmitted through the core.

Unbalanced transmission is susceptible to electromagnetic interference, especially at low levels, such as microphone signals and when using long cables.

In a professional environment, therefore, the balanced transmission is preferred, because this enables an undisturbed transmission of signals over long distances. In addition to the conductors 'Ground' and 'Signal', in a balanced transmission a second core is added. This also transfers the signal, but phase-shifted by 180°.

Since the interference affects both cores equally, by subtracting the phase-shifted signals, the interfering signal is completely neutralized. The result is a pure signal without any noise interference.

### 1/4" TS phone plug (mono, unbalanced)



1	Signal
2	Ground, shielding

### 1/4" TRS phone plug (mono, balanced)



1	Signal (in phase, +)
2	Signal (out of phase, -)
3	Ground

**1/4" TRS phone plug (stereo, unbalanced)**



1	Signal (left)
2	Signal (right)
3	Ground

**XLR plug (balanced)**

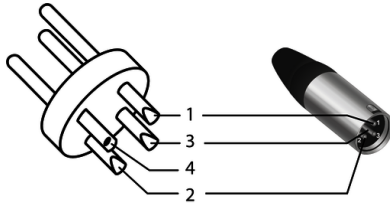

1	Ground, shielding
2	Signal (in phase, +)
3	Signal (out of phase, -)
4	Shielding on plug housing (option)

## XLR plug (unbalanced)

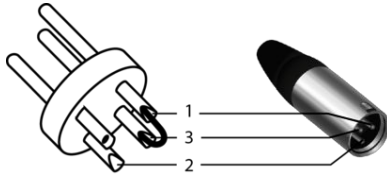

1	Ground, shielding
2	Signal
3	Bridged to pin 1

## RCA connection



Drawing and table indicate the pin assignment of an RCA plug.

1	Signal
2	Ground, shielding



## 8 Protecting the environment

### Disposal of the packaging material



For the transport and protective packaging, environmentally friendly materials have been chosen that can be supplied to normal recycling.

Ensure that plastic bags, packaging, etc. are properly disposed of.

Do not just dispose of these materials with your normal household waste, but make sure that they are collected for recycling. Please follow the notes and markings on the packaging.

### Disposal of your old device



This product is subject to the European Waste Electrical and Electronic Equipment Directive (WEEE) in its currently valid version. Do not dispose with your normal household waste.

Dispose of this device through an approved waste disposal firm or through your local waste facility. When discarding the device, comply with the rules and regulations that apply in your country. If in doubt, consult your local waste disposal facility.





Musikhaus Thomann · Hans-Thomann-Straße 1 · 96138 Burgebrach · Germany · [www.thomann.de](http://www.thomann.de)