



fungeneration

PicoSpot 20 LED
moving head

Musikhaus Thomann
Thomann GmbH
Hans-Thomann-Straße 1
96138 Burgebrach
Germany
Telephone: +49 (0) 9546 9223-0
E-mail: info@thomann.de
Internet: www.thomann.de

18.11.2019, ID: 372642 (V2)

Table of contents

1	General information	5
	1.1 Further information.....	6
	1.2 Notational conventions.....	7
	1.3 Symbols and signal words.....	8
2	Safety instructions	11
3	Features	19
4	Installation	21
5	Starting up	25
6	Connections and operating elements	27
7	Operating	30
	7.1 Starting the device.....	30
	7.2 Function selection.....	31
	7.2.1 DMX menu.....	32
	7.2.2 Scene menu.....	35
	7.2.3 Programme menu.....	39

7.3	Settings menu.....	41
7.4	Functions in 5-channel DMX mode (8-bit).....	48
7.5	Functions in 9-channel DMX mode (16-bit).....	49
7.6	Functions in 11-channel DMX mode (16-bit).....	51
8	Remote control.....	55
9	Technical specifications.....	58
10	Plug and connection assignments.....	61
11	Troubleshooting.....	62
12	Cleaning.....	64
13	Protecting the environment.....	65

1 General information

This user manual contains important information on the safe operation of the device. Read and follow all safety notes and all instructions. Save this manual for future reference. Make sure that it is available to all persons using this device. If you sell the device to another user, be sure that they also receive this manual.

Our products and user manuals are subject to a process of continuous development. We therefore reserve the right to make changes without notice. Please refer to the latest version of the user manual which is ready for download under www.thomann.de.

1.1 Further information

On our website (www.thomann.de) you will find lots of further information and details on the following points:

Download	This manual is also available as PDF file for you to download.
Keyword search	Use the search function in the electronic version to find the topics of interest for you quickly.
Online guides	Our online guides provide detailed information on technical basics and terms.
Personal consultation	For personal consultation please contact our technical hotline.
Service	If you have any problems with the device the customer service will gladly assist you.

1.2 Notational conventions

This manual uses the following notational conventions:

Letterings

The letterings for connectors and controls are marked by square brackets and italics.

Examples: *[VOLUME]* control, *[Mono]* button.

Displays

Texts and values displayed on the device are marked by quotation marks and italics.

Examples: *'24ch'*, *'OFF'*.

Text input

Text inputs that are carried out on the device are indicated by typewriter font.

Example: 2323

Cross-references



References to other locations in this manual are identified by an arrow and the specified page number. In the electronic version of the manual, you can click the cross-reference to jump to the specified location.

Example: See  'Cross-references' on page 8.

1.3 Symbols and signal words

In this section you will find an overview of the meaning of symbols and signal words that are used in this manual.

Signal word	Meaning
DANGER!	This combination of symbol and signal word indicates an immediate dangerous situation that will result in death or serious injury if it is not avoided.
WARNING!	This combination of symbol and signal word indicates a possible dangerous situation that can result in death or serious injury if it is not avoided.
CAUTION!	This combination of symbol and signal word indicates a possible dangerous situation that can result in minor injury if it is not avoided.
NOTICE!	This combination of symbol and signal word indicates a possible dangerous situation that can result in material and environmental damage if it is not avoided.
Warning signs	Type of danger
	Warning – high-voltage.

Warning signs	Type of danger
	Warning – dangerous optical radiation.
	Warning – suspended load.
	Warning – danger zone.

2 Safety instructions

Intended use

This device is intended for use as a freely moving multifunctional spotlight. The device is designed for professional use and is not suitable for use in households. Use the device only as described in this user manual. Any other use or use under other operating conditions is considered to be improper and may result in personal injury or property damage. No liability will be assumed for damages resulting from improper use.

This device may be used only by persons with sufficient physical, sensorial, and intellectual abilities and having corresponding knowledge and experience. Other persons may use this device only if they are supervised or instructed by a person who is responsible for their safety.

Extend the operating life of the device by regular breaks and by avoiding frequent switching on and off. The device is not suitable for continuous operation.

Safety



DANGER!

Danger for children

Ensure that plastic bags, packaging, etc. are disposed of properly and are not within reach of babies and young children. Choking hazard!

Ensure that children do not detach any small parts (e.g. knobs or the like) from the unit. They could swallow the pieces and choke!

Never let children unattended use electrical devices.



DANGER!

Electric shock caused by high voltages inside

Within the device there are areas where high voltages may be present. Never remove any covers.

There are no user-serviceable parts inside.

Do not use the device if covers, protectors or optical components are missing or damaged.



DANGER!

Electric shock caused by short-circuit

Always use proper ready-made insulated mains cabling (power cord) with a protective contact plug. Do not modify the mains cable or the plug. Failure to do so could result in electric shock/death or fire. If in doubt, seek advice from a registered electrician.



WARNING!

Eye damage caused by high light intensity

Never look directly into the light source.



WARNING!

Risk of epileptic shock

Strobe lighting can trigger seizures in photosensitive epilepsy. Sensitive persons should avoid looking at strobe lights.



WARNING!

Risk of injury caused by falling objects

Make sure that the installation complies with the standards and rules that apply in your country. Always secure the device with a secondary safety attachment, such as a safety cable or a safety chain.

The load capacity of trusses or other fixtures must be sufficient for the intended number of devices. Note that the movement of the head places additional loads on the load-bearing parts.



CAUTION!

Risk of injury due to movements of the device

The head of the device can move quickly (pan, tilt) and can produce very bright light. This is also valid immediately after you turn on the device, when the device operates in automatic mode or under remote control and when you turn off a DMX controller that is connected to the device. Persons staying near the device could be injured or frightened.

Before you turn on the device and during the operation, always ensure that nobody stays close to the device. If work has to be performed in the area of movement or in the near vicinity of the device, it must remain turned off.



NOTICE!

Risk of fire

Do not block areas of ventilation. Do not install the device near any direct heat source. Keep the device away from naked flames.



NOTICE!

Operating conditions

This device has been designed for indoor use only. To prevent damage, never expose the device to any liquid or moisture. Avoid direct sunlight, heavy dirt, and strong vibrations.

Only operate the device within the ambient conditions specified in the chapter 'Technical specifications' of this user manual. Avoid heavy temperature fluctuations and do not switch the device on immediately after it was exposed to temperature fluctuations (for example after transport at low outside temperatures).

Dust and dirt inside can damage the unit. When operated in harmful ambient conditions (dust, smoke, nicotine, fog, etc.), the unit should be maintained by qualified service personnel at regular intervals to prevent overheating and other malfunction.

The device must not be moved during use.



NOTICE!

Power supply

Before connecting the device, ensure that the input voltage (AC outlet) matches the voltage rating of the device and that the AC outlet is protected by a residual current circuit breaker. Failure to do so could result in damage to the device and possibly injure the user.

Unplug the device before electrical storms occur and when it is unused for long periods of time to reduce the risk of electric shock or fire.



NOTICE!

Possible staining

The plasticiser contained in the rubber feet of this product may possibly react with the coating of your parquet, linoleum, laminate or PVC floor and after some time cause permanent dark stains.

In case of doubt, do not put the rubber feet directly on the floor, but use felt-pad floor protectors or a carpet.



NOTICE!

Possible damage due to installation of a wrong fuse

The use of different types of fuses can cause serious damage to the unit. Fire hazard!

Only fuses of the same type may be used.

3 Features

The moving head is particularly suitable for professional lighting tasks, for example at events, on rock stages, in theatres and musicals, in nightclubs as well as for mobile DJ's and entertainer.

Special features of the device:

- Two movable axes with 8 or 16 bit resolution:
 - Tilt (200°)
 - Pan (540°)
- Pan and Tilt invertible
- 4 × 12 W CREE High Performance white light LED
- Beam angle 13°
- Control via DMX (5, 9 or 11 channels) and via buttons and display on the unit
- Automatic mode with 7 preprogrammed shows
- Colour wheel with 7 colours plus white
- Gobo wheel with 7 static gobos plus open
- Gobo Scroll mode
- Manual focus
- Sound-to-Light with 7 built-in shows

- Electronic dimmer 0 to 100%
- Shutter frequency 0...20 Hz
- Display inversion
- Omega bracket and infrared remote control included

For technological reasons, the light output of LEDs decreases over their lifetime. This effect increases with higher operating temperature. You can extend the service life of the illuminants by providing adequate ventilation and operating the LEDs with the lowest possible brightness.

4 Installation

Unpack and check carefully there is no transportation damage before using the unit. Keep the equipment packaging. To fully protect the product against vibration, dust and moisture during transportation or storage use the original packaging or your own packaging material suitable for transport or storage, respectively.



WARNING!

Risk of injury caused by falling objects

Make sure that the installation complies with the standards and rules that apply in your country. Always secure the device with a secondary safety attachment, such as a safety cable or a safety chain.

The load capacity of trusses or other fixtures must be sufficient for the intended number of devices. Note that the movement of the head places additional loads on the load-bearing parts.



CAUTION!

Risk of injury due to movements of the device

The head of the device can move quickly (pan, tilt) and can produce very bright light. This is also valid immediately after you turn on the device, when the device operates in automatic mode or under remote control and when you turn off a DMX controller that is connected to the device. Persons staying near the device could be injured or frightened.

Before you turn on the device and during the operation, always ensure that nobody stays close to the device. If work has to be performed in the area of movement or in the near vicinity of the device, it must remain turned off.



NOTICE!

Risk of overheating

The distance between light output and the illuminated surface must be more than 1.5 m (19.7in).

Provide sufficient ventilation.

The ambient temperature must always be below 40 °C (104 °F).



NOTICE!

Possible damage caused by movements of the device

Always ensure that enough space is free around the device for the movements of the head (pan, tilt).



NOTICE!

Possible data transmission errors

For error-free operation make use of dedicated DMX cables and do not use ordinary microphone cables.

Never connect the DMX input or output to audio devices such as mixers or amplifiers.



Please note that this device must not be connected to a dimmer.

Mounting options

You can install the device on the wall, the ceiling or on the floor.

The threads on the housing bottom are used to secure the supplied Omega bracket or truss clamps.

5 Starting up

Create all connections while the device is off. Use the shortest possible high-quality cables for all connections. Take care when running the cables to prevent tripping hazards.

Connections in DMX mode

Connect the DMX input of the device to the DMX output of a DMX controller or another DMX device. Connect the output of the first DMX device to the input of the second one, and so on to form a daisy chain. Always ensure that the output of the last DMX device in the daisy chain is terminated with a resistor ($110\ \Omega$, $\frac{1}{4}\text{ W}$).

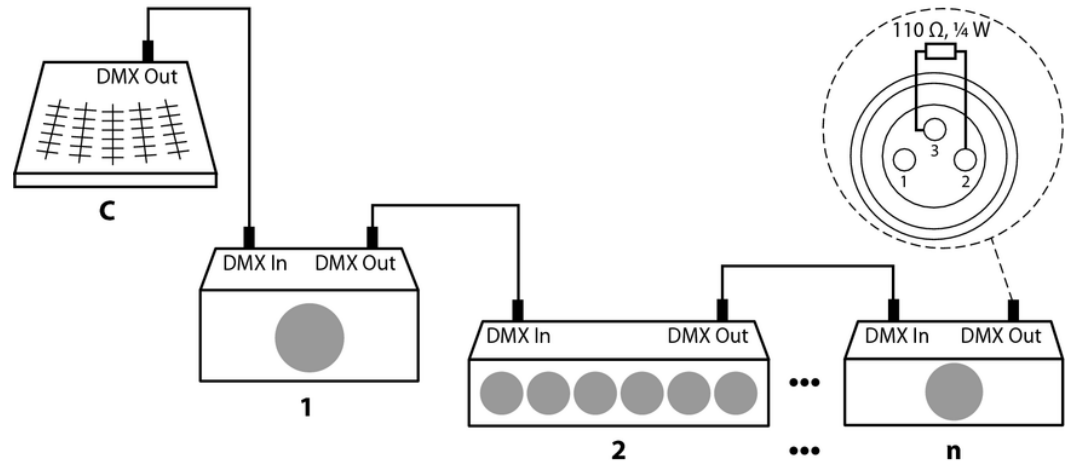

6 Connections and operating elements

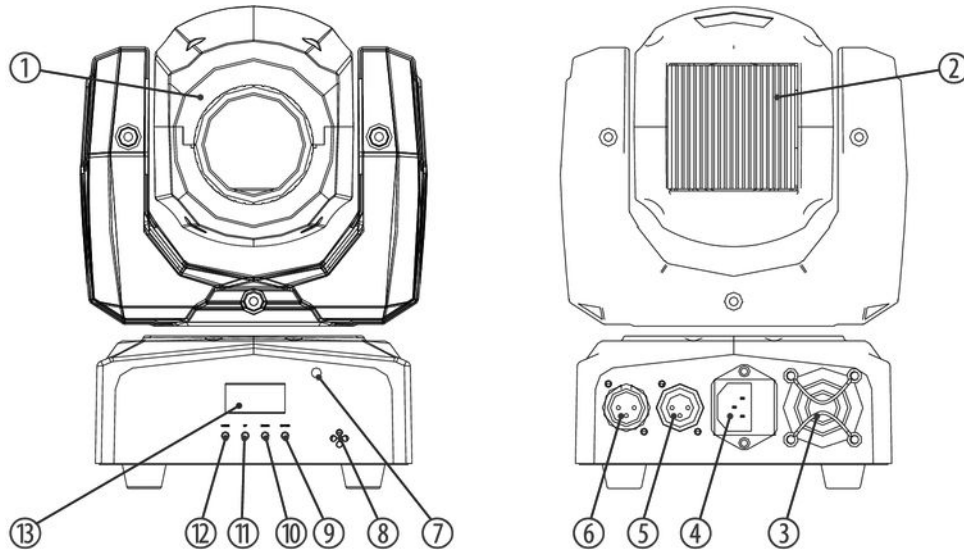

PicoSpot 20 LED

1	Light aperture
2	Heat sink
3	Fan
4	IEC chassis plug for the mains cable with fuse holder
5	<i>[DMX Out]</i> DMX output
6	<i>[DMX In]</i> DMX input
7	Infrared sensor for receiving remote control signals
8	Microphone for sound control
9	<i>[ENTER]</i> Calls up the menu for the respective operation mode, confirms a set value
10	<i>[DOWN]</i> Decreases the displayed value by one and selects menu items

11	<i>[UP]</i> Increases the displayed value by one and selects menu items
12	<i>[MODE]</i> Calls up the settings menu, skips one menu level back and closes an opened submenu without saving any changes
13	Display

7 Operating

7.1 Starting the device



CAUTION!

Risk of injury due to movements of the device

The head of the device can move quickly (pan, tilt) and can produce very bright light. This is also valid immediately after you turn on the device, when the device operates in automatic mode or under remote control and when you turn off a DMX controller that is connected to the device. Persons staying near the device could be injured or frightened.

Before you turn on the device and during the operation, always ensure that nobody stays close to the device. If work has to be performed in the area of movement or in the near vicinity of the device, it must remain turned off.

Connect the device to the power supply to start operation. After a few seconds, the fans start to work, the head moves to the home positions for rotation (pan) and inclination (tilt). After a few more seconds, the display shows 'A001'. The device is now operational.

7.2 Function selection

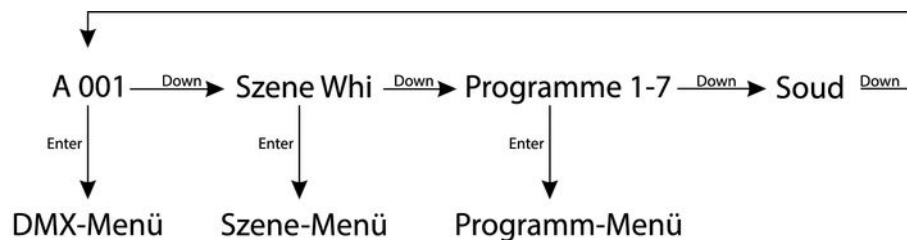

Press **[DOWN]** while 'A001' is flashing in the display to call up the preprogrammed scene. Press repeatedly **[DOWN]** to call one of the 7 programmes. If necessary, press repeatedly **[DOWN]** to set the device to sound-to-light mode.

7.2.1 DMX menu

Press **[ENTER]** while 'A001' is flashing in the display to select the DMX menu. Press **[ENTER]** to call up the first menu item.

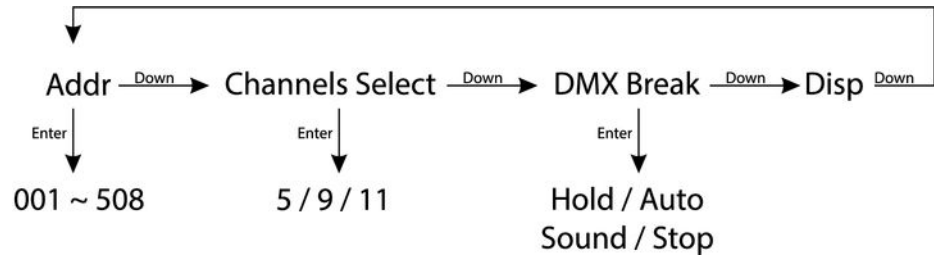

DMX address

The display shows 'Addr'. Press *[ENTER]*, then use *[UP]* and *[DOWN]* to adjust the first DMX channel to be used by the device (DMX address) in a range from 001 to max. 512.

When the display shows the desired value, press *[ENTER]* to confirm the setting and then *[DOWN]* to proceed to the next menu item. To change the menu item without making any changes, press *[MODE]*.

Make sure that this number matches the configuration of your DMX controller. The following table shows the highest possible DMX address for the various DMX modes.

Mode	Highest possible DMX address
5 channels	508
9 channels	504
11 channels	502

Selecting the number of DMX channels

The display shows 'ChS'. Press *[ENTER]*, then use *[UP]* and *[DOWN]* to select the number of DMX channels to be used by the device. Control via 5, 9 or 11 channels is available.

When the display shows the desired value, press *[ENTER]* to confirm the setting and then *[DOWN]* to proceed to the next menu item. To change the menu item without making any changes, press *[MODE]*.

DMX break

The display shows 'brk'. Press *[ENTER]*, then use *[UP]* and *[DOWN]* to select a certain behaviour for the device in case of interrupted DMX connection. Choose 'Hold' if you want the device in that case to maintain the state that corresponds to the last received DMX signal. Choose 'Hold' if you want the device in that case to perform an automatic run. Choose 'Sound' if you want the device in that case to perform a sound-controlled automatic run. Choose 'Sound' if you want the device in that case to return to its home position.

When the display shows the desired value, press *[ENTER]* to confirm the setting and then *[DOWN]* to proceed to the next menu item. To change the menu item without making any changes, press *[MODE]*.

Display

The display shows 'disp'. Press [ENTER], then use [UP] and [DOWN] to select whether you want the display to show the DMX address of the device ('Addr') or the DMX value for the current channel ('VALu').

When the display shows the desired value, press [ENTER] to store the setting and then twice [MODE] to return to the function selection. To change the menu item without making any changes, press [MODE].

7.2.2 Scene menu

Press [DOWN] while 'A001' is flashing on the display to call up the preprogrammed  scene. Press [ENTER] twice to open the Scene menu and to change scene parameters as desired.

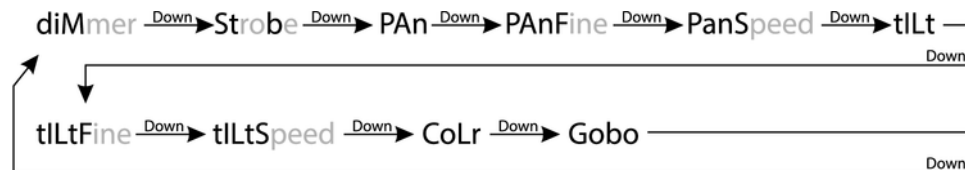

Dimmer

The display shows $\square \square \square$. Press *[ENTER]*, then use *[UP]* and *[DOWN]* to set a value between 000 and 255 for the intensity of the light effect.

When the display shows the desired value press *[ENTER]* to store the setting. To change the menu item without making any changes, press *[MODE]*.

Strobe

Press *[DOWN]*. The display shows $\square \square \square$. Press *[ENTER]*, then use *[UP]* and *[DOWN]* to set a value between 010 and 255 for the strobe frequency of the light effect. Values between 000 and 009 have no function here.

When the display shows the desired value press *[ENTER]* to store the setting. To change the menu item without making any changes, press *[MODE]*.

Rotation

Press *[DOWN]*. The display shows $\square \square \square$. Press *[ENTER]*, then use *[UP]* and *[DOWN]* to set a value between 000 and 255 for the head position on the axis of rotation.

When the display shows the desired value press *[ENTER]* to store the setting. To change the menu item without making any changes, press *[MODE]*.

Fine tuning Rotation

Press *[DOWN]*. The display shows $\overline{P} \overline{P} \overline{r} \overline{r} \overline{F}$. Press *[ENTER]*, then use *[UP]* and *[DOWN]* to set a value between 000 and 255 to fine tune the head position on the axis of rotation.

When the display shows the desired value press *[ENTER]* to store the setting. To change the menu item without making any changes, press *[MODE]*.

Rotation speed

Press *[DOWN]*. The display shows $\overline{P} \overline{P} \overline{r} \overline{r} \overline{S}$. Press *[ENTER]*, then use *[UP]* and *[DOWN]* to set a value between 000 and 255 for the rotation speed.

When the display shows the desired value press *[ENTER]* to store the setting. To change the menu item without making any changes, press *[MODE]*.

Inclination

Press *[DOWN]*. The display shows $\overline{I} \overline{I} \overline{I}$. Press *[ENTER]*, then use *[UP]* and *[DOWN]* to set a value between 000 and 255 for the head inclination.

When the display shows the desired value press *[ENTER]* to store the setting. To change the menu item without making any changes, press *[MODE]*.

Fine tuning Inclination

Press *[DOWN]*. The display shows $\frac{1}{2} \frac{1}{2} \frac{1}{2} F$. Press *[ENTER]*, then use *[UP]* and *[DOWN]* to set a value between 000 and 255 to fine tune the head inclination.

When the display shows the desired value press *[ENTER]* to store the setting. To change the menu item without making any changes, press *[MODE]*.

Inclination speed

Press *[DOWN]*. The display shows $\frac{1}{2} \frac{1}{2} \frac{1}{2} S$. Press *[ENTER]*, then use *[UP]* and *[DOWN]* to set a value between 000 and 255 for the head inclination speed.

When the display shows the desired value press *[ENTER]* to store the setting. To change the menu item without making any changes, press *[MODE]*.

Colour

Press *[DOWN]*. The display shows $\frac{1}{2} \frac{1}{2} \frac{1}{2} C$. Press *[ENTER]*, then use *[UP]* and *[DOWN]* to set a value between 000 and 255 for the colour of the light effect.

When the display shows the desired value press *[ENTER]* to store the setting. To change the menu item without making any changes, press *[MODE]*.

Gobo

Press **[DOWN]**. The display shows . Press **[ENTER]**, then use **[UP]** and **[DOWN]** to set a value between 000 and 255 for the gobo shape of the light effect.

When the display shows the desired value press **[ENTER]** to store the setting. To change the menu item without making any changes, press **[MODE]**. Press **[MODE]** twice to return to the function selection.

7.2.3 Programme menu

Press repeatedly **[DOWN]** while 'A001' is flashing in the display to select one of the 7 preprogrammed shows 'PrG1' to 'PrG7'. Press **[ENTER]** twice to open the Programme menu and to change show parameters as desired.

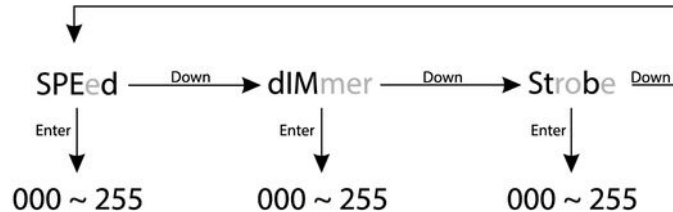

Speed

The display shows $\frac{5}{P}E \frac{d}{d}$. Press *[ENTER]* and then use *[UP]* and *[DOWN]* to adjust a value between 000 and 255 for the duration for which the head should remain in each programmed position before it moves to the next.

When the display shows the desired value press *[ENTER]* to store the setting. To change the menu item without making any changes, press *[MODE]*.

Dimmer

Press *[DOWN]*. The display shows $\frac{d}{d} | \frac{f}{f}$. Press *[ENTER]*, then use *[UP]* and *[DOWN]* to set a value between 000 and 255 for the light intensity of the show.

When the display shows the desired value press *[ENTER]* to store the setting. To change the menu item without making any changes, press *[MODE]*.

Strobe

Press *[DOWN]*. The display shows 'Strobe'. Press *[ENTER]*, then use *[UP]* and *[DOWN]* to set a value between 010 and 255 for the strobe frequency of the show. Values between 000 and 009 have no function here.

When the display shows the desired value press *[ENTER]* to store the setting. To change the menu item without making any changes, press *[MODE]*. Press *[MODE]* twice to return to the function selection.

7.3 Settings menu

In this menu you can configure the device according your liking. All previous settings are retained even when you switch the device off and disconnect it from the mains. Press *[MODE]* and confirm with *[ENTER]* to open the settings menu **5E1**.

Resetting to factory defaults

Press *[ENTER]* to call up the first menu item **1E1**. With this function, you can reset the device to its factory default setting. All your previously adjusted settings are thereby irretrievably erased.

If you want to enable this function use *[UP]* and *[DOWN]* to select 'on' and confirm with *[ENTER]*. If you want to disable this function use *[UP]* and *[DOWN]* to select 'off' and confirm with *[ENTER]*.

Reset Machine

If necessary, press *[DOWN]* repeatedly and confirm with *[ENTER]* to call up the menu item **151**. Use this function to reset positions and colours to their respective programmed parameters.

If you want to execute this function use *[UP]* and *[DOWN]* to select 'on' and confirm with *[ENTER]*. If you do not want to execute this function select 'off' and confirm with *[ENTER]*.

Master and Stand-alone operation

If necessary, press *[DOWN]* repeatedly and confirm with *[ENTER]* to call up the menu item *MASTER*. Use this function to specify whether the device operates as 'Master' (*MASTER*) and controls other units, or works in 'Stand-alone' mode (*STAND*).

Use *[UP]* and *[DOWN]* to select the desired function and confirm with *[ENTER]*.

Auto and Sound

If necessary, press *[DOWN]* repeatedly and confirm with *[ENTER]* to call up the menu item *AUS*. Use this function to specify whether the device operates in Auto mode (*AUTO*) or sound-controlled (*SOUND*).

Use *[UP]* and *[DOWN]* to select the desired function and confirm with *[ENTER]*.

Microphone sensitivity

If necessary, press *[DOWN]* repeatedly and confirm with *[ENTER]* to call up the menu item *MI*. Use this function to specify the sensitivity of the built-in microphone for sound-control.

Use *[UP]* and *[DOWN]* to select the desired sensitivity and confirm with *[ENTER]*.

Clear Display

If necessary, press *[DOWN]* repeatedly and confirm with *[ENTER]* to call up the menu item . Use this function to specify whether you want the display to be always on or if it should turn itself off after approx. 25 seconds. Then only one dot is flashing on the display. When the display is off, press any button to restore illumination.

Use *[UP]* and *[DOWN]* to select 'on' if the display should be always on. Choose 'off' if the display should turn itself off after approx. 25 seconds. Confirm each time with *[ENTER]*.

Key Lock

If necessary, press *[DOWN]* repeatedly and confirm with *[ENTER]* to call up the menu item . Use this function to specify whether the buttons on the device are automatically locked against unintentional operation 30 seconds after the last operation.

Use *[UP]* and *[DOWN]* to select 'on' if the buttons should be locked. Select 'off' if the buttons should not be locked. Confirm each time with *[ENTER]*.



To unlock the buttons during operation for 30 seconds, press successively [MODE], [DOWN], [UP] and [ENTER].

Information

If necessary, press *[DOWN]* repeatedly and confirm with *[ENTER]* to call up the menu item I n F o .

Use *[UP]* and *[DOWN]* to display information about manufacturer, model no., and date and time of production. Press *[ENTER]* to return to the parent menu level.

Operating hours counter

If necessary, press *[DOWN]* repeatedly and confirm with *[ENTER]* to call up the menu item P R C h .

The display shows $\text{h' } \underline{\quad}$. Press *[ENTER]* to display the time in minutes since the last power-up. Press *[ENTER]* to clear the display.

Press *[DOWN]*. The display shows $\text{h' } \underline{\quad} \text{m}$. Press *[ENTER]* to display the entire elapsed operating hours. Press *[ENTER]* to clear the display.

Press *[DOWN]*. The display shows $\text{h' } \underline{\quad} \text{m}$. Press *[ENTER]* and use *[UP]* and *[DOWN]* to enter the password to delete the entire previous operating time. Upon delivery, the password is '001'. The display shows 'no'. Press *[UP]* or *[DOWN]* to switch on 'YES'. Press *[ENTER]* to delete the entire elapsed operating time.

Press *[MODE]* repeatedly until the display shows P R C h again.

Display inverting

If necessary, press *[DOWN]* repeatedly and confirm with *[ENTER]* to call up the menu item $\text{r d} \text{ 5}$. Use this function to specify whether you want the display to appear normally or vertically inverted. This makes reading the display easier when the device is installed upside down.

Use *[UP]* and *[DOWN]* to select 'on' if the display should appear inverted. Select 'off' if the display should not appear inverted. Confirm each time with *[ENTER]*.

Motor Set

If necessary, press *[DOWN]* repeatedly and confirm with *[ENTER]* to call up the menu item 15E1 . Press *[ENTER]* again, the display shows bL 1 d . This function allows you to specify whether the LED lights up in DMX mode during the movements of the device head or not.

Press *[ENTER]* to call up the function. Use *[UP]* and *[DOWN]* to select 'on' and press *[ENTER]* to enable this function (LED 'off' on DMX-controlled movements). Choose 'off' and press *[ENTER]* to disable this function (LED 'on' on DMX-controlled movements).

Press *[MODE]* repeatedly until the display shows 15E1 again.

Inverting Pan / Tilt

If necessary, press [DOWN] repeatedly and confirm with [ENTER] to call up the menu item $\overline{\text{PSE}}$. Press [ENTER] again, the display shows $\overline{\text{P T}}$. Use [UP] and [DOWN] to select $\overline{\text{P T}}$ and press [ENTER]. This function allows you to specify whether the Pan/Tilt movements should be inverted.

Press [ENTER] to call up the function. Use [UP] and [DOWN] to call up 'PAN' or 'TILT' and press [ENTER]. Select the menu item 'rEV' to set the desired value for the inversion with 'no' or 'yes'.

Press [MODE] repeatedly until the display shows $\overline{\text{PSE}}$ again.

Recording scenes

If necessary, press [DOWN] repeatedly and confirm with [ENTER] to call up the menu item $\overline{\text{RE}}$. Here you can assign the scene currently performed by the device to the memory location for the scene $\overline{\text{R H}}$.

Press [ENTER] twice. The display shows 'no'. Press [UP] or [DOWN] and confirm the display 'Yes' with [ENTER] to save the scene. This will overwrite the previously saved parameters for this scene.

Press [MODE] repeatedly until the display shows $\overline{\text{RE}}$ again.

Advanced menu

If necessary, press *[DOWN]* repeatedly and confirm with *[ENTER]* to call up the menu item *PUK*. Here you can change the password that protects the access to some menu options to prevent unauthorized access. The display shows *PUK 638*.

Press *[UP]* or *[DOWN]* and confirm with *[ENTER]* to call up the menu item *PASSWORD CHANGE*. Press *[ENTER]* again. Keep *[DOWN]* pressed until the PUK code 638 is displayed. Press *'ENTER'*. The display shows *PUK 638*. Confirm with *[ENTER]*. The display shows the current password. Use *[UP]* and *[DOWN]* to select a new password and press *'ENTER'* to save it.

Press *[MODE]* repeatedly to return to the respectively parent menu level or to leave the menu.



If you enter an incorrect PUK code, the error message 'Password Err' scrolls on the display until you press ENTER. Then enter the correct PUK code.

7.4 Functions in 5-channel DMX mode (8-bit)

Channel	Value	Function	
1	0...255	Rotation (pan) (0° up to the maximum value of the Pan range of 540°)	
2	0...255	Inclination (tilt) (0° up to the maximum value of the Tilt range of 200°)	
3	0...255	Motor speed (fast to slow)	
4	0...255	000...010	White
		011...021	Red
		022...032	Orange
		033...043	Yellow
		044...054	Green
		055...065	Blue
		066...076	Cyan
		077...087	Purple

Channel	Value	Function
		088...175 Colour selection 6+
		176...255 Colour wheel rotation
5	0...255	Master dimmer 0 – 100%

7.5 Functions in 9-channel DMX mode (16-bit)

Channel	Value	Function
1	0...255	Rotation (pan) (0° up to the maximum value of the Pan range of 540°)
2	0...255	Inclination (tilt) (0° up to the maximum value of the Tilt range of 200°)
3	0...255	Fine adjustment rotation (pan)
4	0...255	Fine adjustment inclination (tilt)
5	0...255	Motor speed (fast to slow)

Channel	Value	Function	
6	0...255	000...010	White
		011...021	Red
		022...032	Orange
		033...043	Yellow
		044...054	Green
		055...065	Blue
		066...076	Cyan
		077...087	Purple
		088...175	Colour selection 6+
		176...255	Colour wheel rotation
7	0...255	000...124	Gobo selection
		125...249	Gobo shake selection
		250...255	Gobo wheel selection

Channel	Value	Function	
8	0...255	Master dimmer 0 – 100%	
9	0...255	000...009	No function (open)
		010...255	Strobe effect (1 Hz...25 Hz)

7.6 Functions in 11-channel DMX mode (16-bit)

Channel	Value	Function
1	0...255	Rotation (pan) (0° up to the maximum value of the Pan range of 540°)
2	0...255	Inclination (tilt) (0° up to the maximum value of the Tilt range of 200°)
3	0...255	Fine adjustment rotation (pan)
4	0...255	Fine adjustment inclination (tilt)
5	0...255	Motor speed (fast to slow)

Channel	Value	Function	
6	0...255	000...010	White
		011...021	Red
		022...032	Orange
		033...043	Yellow
		044...054	Green
		055...065	Blue
		066...076	Cyan
		077...087	Purple
		088...175	Colour selection 6+
		176...255	Colour wheel rotation
7	0...255	000...124	Gobo selection
		125...249	Gobo shake selection
		250...255	Gobo wheel selection

Channel	Value	Function	
8	0...255	Master dimmer 0 – 100%	
9	0...255	000...009	No function (open)
		010...255	Strobe effect (1 Hz...25 Hz)
10	0...255	000...049	No function
		050...059	White
		060...069	Scene 02 (empty)
		070...079	Scene 03 (empty)
		080...089	Scene 04 (empty)
		090...099	Scene 05 (empty)
		100...109	Scene 06 (empty)
		110...119	Scene 07 (empty)
		120...129	Scene 08 (empty)
		130...139	Scene 09 (empty)

Channel	Value	Function	
		140...149	Programme 1
		150...159	Programme 2
		160...169	Programme 3
		170...179	Programme 4
		180...189	Programme 5
		190...199	Programme 6
		200...209	Programme 7
		210...219	Programme 8 (empty)
		220...229	Programme 9 (empty)
		230...239	Empty
		240...249	Empty
		250...255	Sound-controlled operation
11	0...255	000...255	Speed 0...100%

8 Remote control

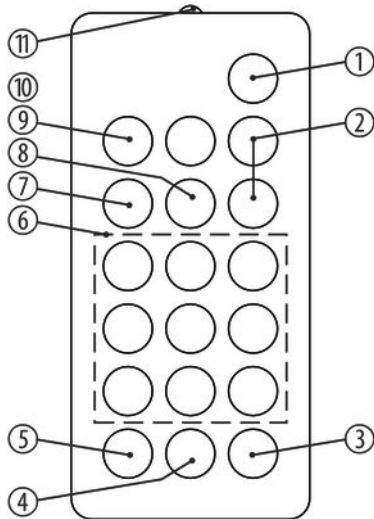

To use the remote control, point its infrared diode at the infrared sensor on the unit and press the desired buttons. The maximum operating distance is about 9 m. The device will only respond to the remote control signals if it is not controlled via DMX.

To enable the operation via remote control, press *[STAND BY]* on the remote control and then *[FULL ON]*.

1 *[STAND BY]*

Stops the automatic mode and blackouts the unit. The display shows 'StoP'. In this mode, the device responds to the remote control.

2 *[Dimmer +/-]*

Adjusts the light intensity between 0 and 100 %. Press *[Dimmer +]* repeatedly or keep the button pressed to increase the light intensity. Press *[Dimmer-]* repeatedly or keep the button pressed to decrease the light intensity.

3 *[SOUND OFF]*

Deactivates the sound-control.

4	<i>[SHOW]</i> To call up one of the 7 preprogrammed automatic shows, press this button followed by the number button 1 – 9 for the desired show. To cancel a show, press <i>[STAND BY]</i> .									
5	<i>[SOUND ON]</i> Activates the sound-control.									
6	Number buttons These buttons allow you to trim the rotation (X) and tilt (Y) of the device head: <table><tr><td>Button 1: X- & Y+</td><td>Button 4: X-</td><td>Button 7: X- & Y-</td></tr><tr><td>Button 2: Y+</td><td>Button 5: Centre</td><td>Button 8: Y-</td></tr><tr><td>Button 3: X+ & Y+</td><td>Button 6: X+</td><td>Button 9: X+ & Y-</td></tr></table>	Button 1: X- & Y+	Button 4: X-	Button 7: X- & Y-	Button 2: Y+	Button 5: Centre	Button 8: Y-	Button 3: X+ & Y+	Button 6: X+	Button 9: X+ & Y-
Button 1: X- & Y+	Button 4: X-	Button 7: X- & Y-								
Button 2: Y+	Button 5: Centre	Button 8: Y-								
Button 3: X+ & Y+	Button 6: X+	Button 9: X+ & Y-								
7	<i>[STROBE]</i> Enables the Strobe function for the current light scene. Then press one of the number buttons 2 – 9 for the desired strobe frequency. Press number button 1 to turn the Strobe function off.									

8	<i>[COLOR]</i> To call up various colours for the current light scene. Then press one of the number buttons 1 – 8 for the desired colour.
9	<i>[FULL ON]</i> Press this button to call up the programmed light scene.
10	<i>[GOBO]</i> To call up various Gobos for the current light scene. Then press one of the number buttons 1 – 8 for the desired Gobo.
11	Infrared diode Sends the infrared signals to the device.

9 Technical specifications

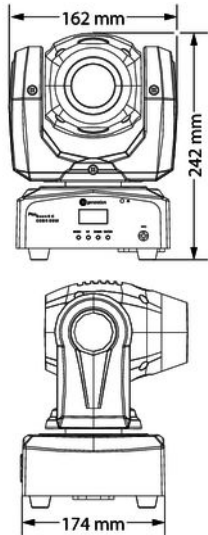

Light source	1 × 12 W CREE High Performance white light LED	
Light source properties	Colour temperature	8000 K
	Colour rendering index	70 CRI Ra
Optical properties	Beam angle	13°
Rotation angle (pan), max.	200°	
Inclination angle (tilt), max.	540°	
Control	DMX	
	Buttons and display on the unit	
	Infrared remote control	
Number of DMX channels	5, 9, 11	
Input connections	Power supply	IEC chassis plug C14
	DMX control	XLR chassis socket, 3-pin

Output connections	DMX control	XLR chassis socket, 3-pin
Power consumption	35 W	
Supply voltage	100 – 240 V ~ 50/60 Hz	
Fuse	5 mm × 20 mm, 2 A, 250 V, fast-acting	
Degree of protection	IP20	
Mounting options	Standing, hanging	
Dimensions (W × H × D)	162 mm × 242 mm × 174 mm	
Weight	3 kg	
Ambient conditions	Temperature range	0 °C...40 °C
	Relative humidity	50 %, non-condensing

Further information

Type	Spot
Colour mixture	Colour wheel
Motorized zoom	No
Motorized focus	No
Rotating gobos	No
Static gobos	Yes
Number of colour wheels	1
Iris	No
Prism	No

10 Plug and connection assignments

Introduction

This chapter will help you select the right cables and plugs to connect your valuable equipment so that a perfect light experience is guaranteed.

Please take our tips, because especially in 'Sound & Light' caution is indicated: Even if a plug fits into a socket, the result of an incorrect connection may be a destroyed DMX controller, a short circuit or 'just' a not working light show!

DMX connections

The unit offers a 3-pin XLR socket for DMX output and a 3-pin XLR plug for DMX input. Please refer to the drawing and table below for the pin assignment of a suitable XLR plug.



Pin	Configuration
1	Ground, shielding
2	Signal inverted (DMX-, 'cold signal')
3	Signal (DMX+, 'hot signal')

11 Troubleshooting



NOTICE!

Possible data transmission errors

For error-free operation make use of dedicated DMX cables and do not use ordinary microphone cables.

Never connect the DMX input or output to audio devices such as mixers or amplifiers.

In the following we list a few common problems that may occur during operation. We give you some suggestions for easy troubleshooting:

Symptom	Remedy
The unit does not work, no light, the fan does not run	Check the mains connection and the main fuse.
No response to the DMX controller	1. Check the DMX connectors and cables for proper connection.
	2. Check the address settings and the DMX polarity.
	3. Try using another DMX controller.
	4. Check to see if the DMX cables run near or alongside to high voltage cables that may cause damage or interference to DMX interface circuits.

If the procedures recommended above do not succeed, please contact our Service Center. You can find the contact information at www.thomann.de.

12 Cleaning

Optical lenses

Clean the optical lenses, that are accessible from the outside, regularly in order to optimize the light output. The frequency of cleaning depends on the operating environment: wet, smoky or particularly dirty surroundings can cause more accumulation of dirt on the optics of the device.

- Clean with a soft cloth using our lamp and lens cleaner (item no. 280122).
- Always dry the parts carefully.

Fan grids

The fan grids of the device must be cleaned of any contamination, such as dust, etc. on a regular basis. Before cleaning, switch off the device and disconnect mains-operated devices from the mains. Only use pH-neutral, solvent-free and non-abrasive cleaning agents. Clean the unit with a slightly damp lint-free cloth.

13 Protecting the environment

Disposal of the packaging material



For the transport and protective packaging, environmentally friendly materials have been chosen that can be supplied to normal recycling.

Ensure that plastic bags, packaging, etc. are properly disposed of.

Do not just dispose these materials with your normal household waste, but make sure that they are fed to a recovery. Please follow the notes and markings on the packaging.

Disposal of batteries



Batteries must not be disposed of as domestic waste or thrown into fire. Dispose of the batteries according to national or local regulations regarding hazardous waste. To protect the environment, dispose of empty batteries at your retail store or at appropriate collection sites.

Disposal of your old device



This product is subject to the European Waste Electrical and Electronic Equipment Directive (WEEE) in its currently valid version. Do not dispose with your normal household waste.

Dispose this device through an approved waste disposal firm or through your local waste facility. When discarding the device, comply with the rules and regulations that apply in your country. If in doubt, consult your local waste disposal facility.



