

User manual

ignition

Magic Cube 3D

effect panel

Musikhaus Thomann
Thomann GmbH
Hans-Thomann-Straße 1
96138 Burgebrach
Germany
Telephone: +49 (0) 9546 9223-0
E-mail: info@thomann.de
Internet: www.thomann.de

04.05.2021, ID: 412145 (V2)

Table of contents

1	General information	6
	1.1 Further information.....	7
	1.2 Notational conventions.....	8
	1.3 Symbols and signal words.....	8
2	Safety instructions	11
3	Features	15
4	Installation and starting up	16
5	Connections and controls	24
6	Operating	27
	6.1 Starting the device.....	27
	6.2 Main menu.....	27
	6.3 Menu overview.....	34
	6.4 Functions in 9-channel DMX mode.....	35
	6.5 Functions in 14-channel DMX mode.....	36
	6.6 Functions in 17-channel DMX mode.....	37

6.7	Functions in 81-channel DMX mode.....	40
6.8	Functions in 83-channel DMX mode.....	42
6.9	Functions in 98-channel DMX mode.....	43
7	Technical specifications.....	48
8	Plug and connection assignments.....	50
9	Troubleshooting.....	51
10	Cleaning.....	53
11	Protecting the environment.....	54

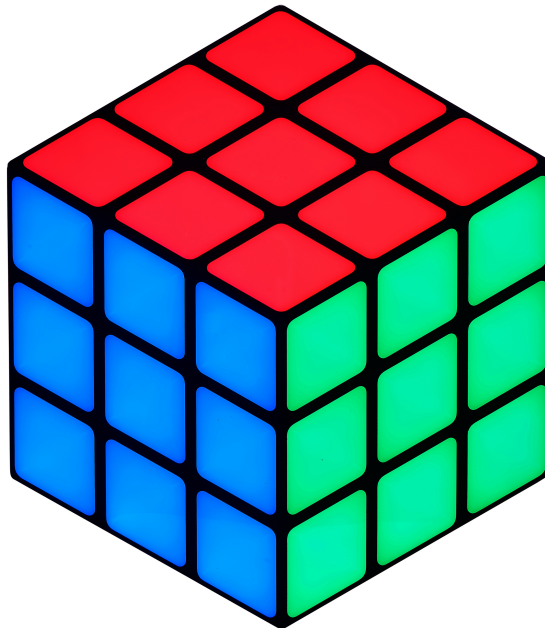

1 General information

This user manual contains important information on the safe operation of the device. Read and follow all safety notes and all instructions. Save this manual for future reference. Make sure that it is available to all persons using this device. If you sell the device to another user, be sure that they also receive this manual.

Our products and user manuals are subject to a process of continuous development. We therefore reserve the right to make changes without notice. Please refer to the latest version of the user manual which is ready for download under www.thomann.de.

1.1 Further information

On our website (www.thomann.de) you will find lots of further information and details on the following points:

Download	This manual is also available as PDF file for you to download.
Keyword search	Use the search function in the electronic version to find the topics of interest for you quickly.
Online guides	Our online guides provide detailed information on technical basics and terms.
Personal consultation	For personal consultation please contact our technical hotline.
Service	If you have any problems with the device the customer service will gladly assist you.

1.2 Notational conventions

This manual uses the following notational conventions:

Letterings

The letterings for connectors and controls are marked by square brackets and italics.

Examples: *[VOLUME]* control, *[Mono]* button.



Displays



Texts and values displayed on the device are marked by quotation marks and italics.

Examples: *'24ch'*, *'OFF'*.

1.3 Symbols and signal words

In this section you will find an overview of the meaning of symbols and signal words that are used in this manual.

Signal word	Meaning
DANGER!	This combination of symbol and signal word indicates an immediate dangerous situation that will result in death or serious injury if it is not avoided.
WARNING!	This combination of symbol and signal word indicates a possible dangerous situation that can result in death or serious injury if it is not avoided.
NOTICE!	This combination of symbol and signal word indicates a possible dangerous situation that can result in material and environmental damage if it is not avoided.
Warning signs	Type of danger
	Warning – high-voltage.
	Warning – dangerous optical radiation.

Warning signs	Type of danger
 A yellow triangular warning sign with a black border, depicting a crane hook lifting a rectangular load.	Warning – suspended load.
 A yellow triangular warning sign with a black border, featuring a large black exclamation mark.	Warning – danger zone.

2 Safety instructions

Intended use

This device is intended for use as an electronic lighting effect by means of LED technology. The device is designed for professional use only and is not suitable for use in households. Use the device only as described in this user manual. Any other use or use under other operating conditions is considered to be improper and may result in personal injury or property damage. No liability will be assumed for damages resulting from improper use.

This device may be used only by persons with sufficient physical, sensorial, and intellectual abilities and having corresponding knowledge and experience. Other persons may use this device only if they are supervised or instructed by a person who is responsible for their safety.



Extend the operating life of the device by regular breaks and by avoiding frequent switching on and off. The device is not suitable for continuous operation.

Safety



DANGER!

Danger for children

Ensure that plastic bags, packaging, etc. are disposed of properly and are not within reach of babies and young children. Choking hazard! Ensure that children do not detach any small parts (e.g. knobs or the like) from the unit. They could swallow the pieces and choke! Never let children unattended use electrical devices.



DANGER!

Electric shock caused by high voltages inside

Within the device there are areas where high voltages may be present. Never remove any covers. There are no user-serviceable parts inside. Do not use the device if covers, protectors or optical components are missing or damaged.



DANGER!

Electric shock caused by short-circuit

Always use proper ready-made insulated mains cabling (power cord) with a protective contact plug. Do not modify the mains cable or the plug. Failure to do so could result in electric shock/death or fire. If in doubt, seek advice from a registered electrician.



WARNING!

Eye damage caused by high light intensity

Never look directly into the light source.

**WARNING!****Risk of epileptic shock**

Strobe lighting can trigger seizures in photosensitive epilepsy. Sensitive persons should avoid looking at strobe lights.

**NOTICE!****Risk of fire**

Do not block areas of ventilation. Do not install the device near any direct heat source. Keep the device away from naked flames.

**NOTICE!****Operating conditions**

This device has been designed for indoor use only. To prevent damage, never expose the device to any liquid or moisture. Avoid direct sunlight, heavy dirt, and strong vibrations. Only operate the device within the ambient conditions specified in the chapter 'Technical specifications' of this user manual. Avoid heavy temperature fluctuations and do not switch the device on immediately after it was exposed to temperature fluctuations (for example after transport at low outside temperatures). Dust and dirt inside can damage the unit. When operated in harmful ambient conditions (dust, smoke, nicotine, fog, etc.), the unit should be maintained by qualified service personnel at regular intervals to prevent overheating and other malfunction.

**NOTICE!****Power supply**

Before connecting the device, ensure that the input voltage (AC outlet) matches the voltage rating of the device and that the AC outlet is protected by a residual current circuit breaker. Failure to do so could result in damage to the device and possibly injure the user. Unplug the device before electrical storms occur and when it is unused for long periods of time to reduce the risk of electric shock or fire.



NOTICE!

Possible damage due to installation of a wrong fuse



The use of different types of fuses can cause serious damage to the unit. Fire hazard! Only fuses of the same type may be used.

3 Features

Special features of this LED panel with 3D effect and segment control:

- 108 RGB SMD LEDs, each 0.8 W
- the innovative arrangement of the selectively controllable surfaces creates the illusion of a magical 3D cube
- flexible mounting options for mounting individual independent panels or in combination in order to realize larger areas
- Control via DMX (six different modes), ArtNet (with separately available external controller) as well as buttons and display on the device
- Automatic mode and sound control
- Master / Slave operation

For technological reasons, the light output of LEDs decreases over their lifetime. This effect increases with higher operating temperature. You can extend the service life of the illuminants by providing adequate ventilation and operating the LEDs with the lowest possible brightness.

4 Installation and starting up

Unpack and check carefully there is no transportation damage before using the unit. Keep the equipment packaging. To fully protect the product against vibration, dust and moisture during transportation or storage use the original packaging or your own packaging material suitable for transport or storage, respectively.

Ceiling or wall mounting

The Quick-lock openings on the case bottom are used for secure mounting. To these, Omega brackets or flight adapters (Half Coupler, Trigger Clamps, C-hooks, etc.) are attached. The safety cable must be threaded through the safety eyelet on the bottom of the device.

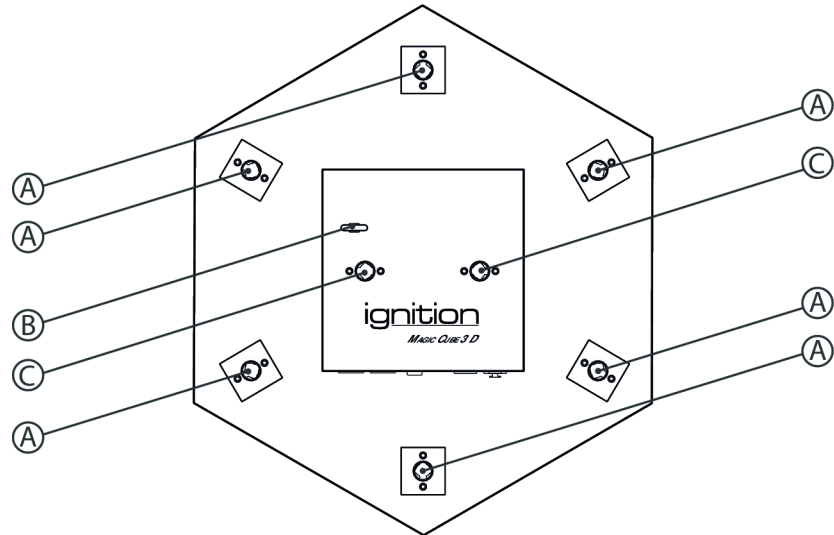

A	Quick-lock openings
B	Safety cable eyelet.
C	Quick-lock openings for omega bracket

Multiple units can be linked together with separately available mounting rails and fixing lugs. Secure each individual device additionally with a safety cable, which is threaded through the safety eyelet on the unit's rear side.



WARNING!

Risk of injury caused by falling objects

Make sure that the installation complies with the standards and rules that apply in your country. Always secure the device with a secondary safety attachment, such as a safety cable or a safety chain.



NOTICE!

Risk of overheating

The distance between light output and the illuminated surface must be more than 1.5 m (19.7in).

Provide sufficient ventilation.

The ambient temperature must always be below 40 °C (104 °F).



NOTICE!

Possible data transmission errors

For error-free operation make use of dedicated DMX cables and do not use ordinary microphone cables.

Never connect the DMX input or output to audio devices such as mixers or amplifiers.

Use appropriate mounting hardware to attach the unit to the ceiling or a wall. The designated fastening area must be sufficiently stable for the load, level and vibration-free.

Create all connections while the device is off. Use the shortest possible high-quality cables for all connections. Take care when running the cables to prevent tripping hazards.

Connections in 'DMX' mode

Connect the DMX input of the device to the DMX output of a DMX controller or other DMX device. Connect the output of the first DMX device to the input of the second one and so on, to form a series connection.

Such a chain may consist of up to 30 DMX devices. Make sure that the output of the last device in the chain is terminated by a resistor (110 Ω , ¼ W).

With active display, a dot is lit in the first digit when the unit is in DMX mode. If the dot is not lit, no valid DMX data is received.

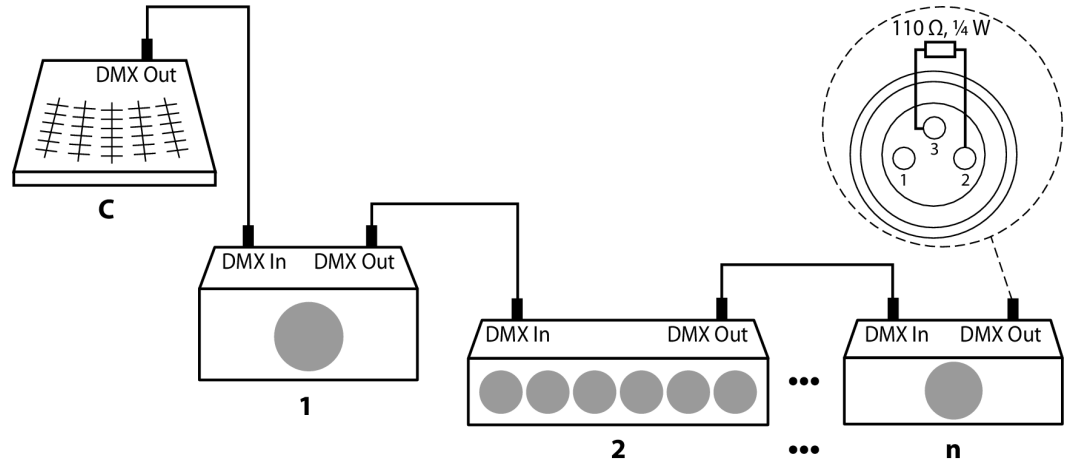

Connections in 'Master / Slave' mode

When you configure a group of devices in 'Master / Slave' mode, the first device controls the others and allows an automatic, music-controlled and synchronized show. This feature is especially useful to start a show without much programming. Connect the DMX output of the master unit to the DMX input of the first slave unit. Then connect the DMX output of the first slave unit to the DMX input of the second slave unit and so on (maximum 30 slaves).



Please note that this device must not be connected to a dimmer.

5 Connections and controls

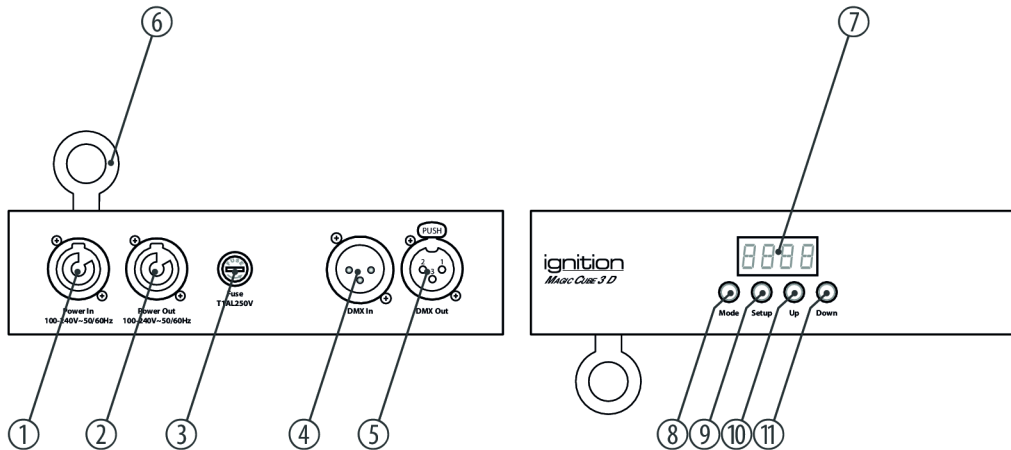

1	<i>[Power In]</i> Lockable input socket (Power Twist) for power supply.
2	<i>[Power Out]</i> Lockable output socket (Power Twist) for the power supply of further units.
3	Fuse holder Should the fuse have blown, disconnect the unit from the power supply and replace the fuse with a new fuse of the same type.
4	<i>[DMX In]</i> DMX input.
5	<i>[DMX Out]</i> DMX output.
6	Safety cable eyelet
7	Display.
8	Button <i>[MODE]</i> Calls up the main menu or a submenu.

9	Button <i>[Setup]</i> Confirms a selected value.
10	Button <i>[Up]</i> Increases the displayed value by one.
11	Button <i>[Down]</i> Decreases the displayed value by one.

6 Operating

6.1 Starting the device

Connect the device to the power supply to start operation. After a few seconds the unit is ready for use.

6.2 Main menu

Press *[Mode]* to activate the main menu. Press again *[Mode]* or *[Up]* | *[Down]* to call up further menu items. To activate the respectively shown menu item, press *[Setup]*. Use *[Up]* and *[Down]* to change the respectively indicated value, and *[Setup]* to confirm it. With *[Mode]* you return to the previous menu level.

If you do not press any key for about 15 seconds, the display will turn off. The set values are retained even when the device is disconnected from the mains power supply.

Auto mode

Press *[Mode]* repeatedly until the display shows 'AUTO'. The unit now operates in automatic stand-alone mode.

Programme mode

Press *[Mode]* repeatedly until the display shows 'Pro'. Press *[Setup]* to then select with *[Up]* | *[Down]* one of the programmes 'Pr.01' ... 'Pr.28'.

If you select 'Pr.01' you can press *[Setup]* and then call up with *[Up]* | *[Down]* one of 50 programmed colour patterns which will then light up constantly (display shows 'CO.01' ... 'CO.50'). Press *[Setup]* to then adjust with *[Up]* | *[Down]* the strobe frequency between 'FL.01' (slow) and 'FL.99' (fast). Select 'FL.00' for constant light.

Programmes 'Pr.02' - 'Pr.28' offer preprogrammed colour sequences. After selecting one of these programmes, press *[Setup]* to then select with *[Up]* | *[Down]* the speed of the colour sequences from 'SP.01' (slow) to 'SP.FL' (fast). Press *[Setup]* to then adjust with *[Up]* | *[Down]* the strobe frequency between 'FL.01' (slow) and 'FL.99' (fast).

DMX address

Press *[Mode]* repeatedly until the display shows 'd---'. Press *[Setup]* to then select with *[Up]* | *[Down]* the desired DMX address between 1 and 512 (the display shows 'd.001' ... 'd.512'). Make sure that this number matches the configuration of your DMX controller.

Press *[Setup]* to then select with *[Up]* | *[Down]* the number of channels (9, 14, 17, 81, 83 or 98) available for DMX operation.

Slave mode

Press *[Mode]* repeatedly until the display shows 'SLAV'. The device is now working in slave mode, i.e. it will exactly copy the movement of the controlling master device, correct wiring provided.

Color mode

Press *[Mode]* or *[Up]* | *[Down]* repeatedly until the display shows 'Colr'. Press *[Setup]*. You can now adjust the intensity of red, green and blue of the LEDs in three segments successively in a range from 0 bis 100 %:

- Display shows 'r1.00' ... 'r1.FL': Intensity red (0 % to 100 %), segment 1
- Display shows 'g1.00' ... 'g1.FL': Intensity green (0 % to 100 %), segment 1
- Display shows 'b1.00' ... 'b1.FL': Intensity blue (0 % to 100 %), segment 1
- Display shows 'r2.00' ... 'r2.FL': Intensity red (0 % to 100 %), segment 2
- Display shows 'g2.00' ... 'g2.FL': Intensity green (0 % to 100 %), segment 2
- Display shows 'b2.00' ... 'b2.FL': Intensity blue (0 % to 100 %), segment 2
- Display shows 'r3.00' ... 'r3.FL': Intensity red (0 % to 100 %), segment 3
- Display shows 'g3.00' ... 'g3.FL': Intensity green (0 % to 100 %), segment 3
- Display shows 'b3.00' ... 'b3.FL': Intensity blue (0 % to 100 %), segment 3

Sound mode

Press *[Mode]* repeatedly until the display shows 'Soud'. The device now shows a sound-controlled colour sequence. Press *[Setup]* to then select with *[Up]* | *[Down]* the sensitivity of the built-in microphone for sound control between 'SU.00' (low) and 'SU.31' (high).

Dimmer curve

Press *[Mode]* repeatedly until the display shows 'Set'. Press *[Setup]*. Use *[Up]* | *[Down]* to select the menu item 'Cur' and confirm with *[Setup]*.

With *[Up]* | *[Down]* you can select one of the following dimmer curves. The dimmer curve determines how the brightness increases or decreases depending on the set DMX value.

Display	Meaning
'Cu-1'	Linear (proportional) course
'Cu-2'	Quadratic curve with a flat profile at the beginning and a steep profile at the end (Square)
'Cu-3'	Inverted quadratic curve with a steep profile at the beginning and a flat profile at the end (Inv Square)
'Cu-4'	Non-linear curve with a distinctive flat profile at the beginning and the end (S-Type)

The below figure schematically shows the adjustable dimmer curves. Depending on the selected DMX value (1) the device lights with a brightness (2) between 0 % and 100 %. Confirm the selection with *[Setup]*. Press *[Mode]*.

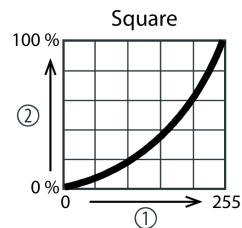
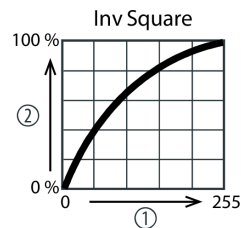
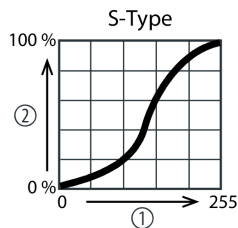
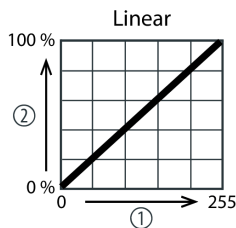

Reset

Press *[Mode]* repeatedly until the display shows 'SEt'. *[Setup]*. Use *[Up]* | *[Down]* to select the menu item 'Rst' and confirm with *[Setup]*. Use *[Up]* | *[Down]* choose between 'Yes' (carry out reset) and 'No' (no reset) and confirm with *[Setup]*.

Behaviour on DMX failure

Press *[Mode]* repeatedly until the display shows 'SEt'. *[Setup]*. Use *[Up]* | *[Down]* to select the menu item 'FAIL' and confirm with *[Setup]*. With *[Up]* | *[Down]* you can choose how the device behaves in case of a disturbed DMX transmission: 'HoLd' (the current state is retained) and 'Off' (device blackout). Confirm the selection with *[Setup]*.

DMX synchronisation

Press *[Mode]* repeatedly until the display shows '*SEt*'. *[Setup]*. Use *[Up]* | *[Down]* to select the menu item '*SYNC*' and confirm with *[Setup]*. With *[Up]* | *[Down]* you can choose how connected devices behaves in case of a disturbed DMX transmission: '*ON*' (devices are synchronised with each other) and '*Off*' (no synchronisation). Confirm the selection with *[Setup]*.

Firmware version

Press *[Mode]* repeatedly until the display shows '*InFo*'. Press *[Setup]*, the display shows '*Ver*'. Press *[Setup]* to let the device show the firmware version.

6.3 Menu overview

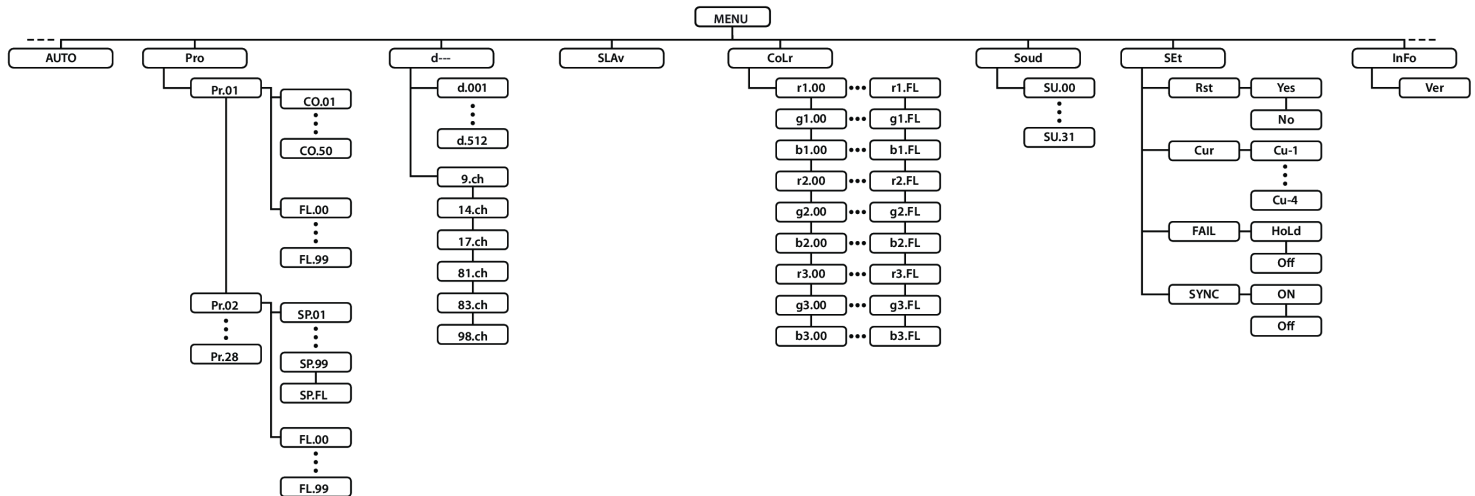

6.4 Functions in 9-channel DMX mode

Channel	Value	Function
1	0...255	Intensity red (0 % to 100 %), segment 1
2	0...255	Intensity green (0 % to 100 %), segment 1
3	0...255	Intensity blue (0 % to 100 %), segment 1
4	0...255	Intensity red (0 % to 100 %), segment 2
5	0...255	Intensity green (0 % to 100 %), segment 2
6	0...255	Intensity blue (0 % to 100 %), segment 2
7	0...255	Intensity red (0 % to 100 %), segment 3
8	0...255	Intensity green (0 % to 100 %), segment 3
9	0...255	Intensity blue (0 % to 100 %), segment 3

6.5 Functions in 14-channel DMX mode

Channel	Value	Function
1	0...255	Dimmer (0 % to 100 %)
2	0...255	Intensity red (0 % to 100 %), all segments
3	0...255	Intensity green (0 % to 100 %), all segments
4	0...255	Intensity blue (0 % to 100 %), all segments
5	0...255	Intensity red (0 % to 100 %), segment 1, if channels 2, 3 and 4 = 0
6	0...255	Intensity green (0 % to 100 %), segment 1, if channels 2, 3 and 4 = 0
7	0...255	Intensity blue (0 % to 100 %), segment 1, if channels 2, 3 and 4 = 0
8	0...255	Intensity red (0 % to 100 %), segment 2, if channels 2, 3 and 4 = 0
9	0...255	Intensity green (0 % to 100 %), segment 2, if channels 2, 3 and 4 = 0
10	0...255	Intensity blue (0 % to 100 %), segment 2, if channels 2, 3 and 4 = 0
11	0...255	Intensity red (0 % to 100 %), segment 3, if channels 2, 3 and 4 = 0

Channel	Value	Function
12	0...255	Intensity green (0 % to 100 %), segment 3, if channels 2, 3 and 4 = 0
13	0...255	Intensity blue (0 % to 100 %), segment 3, if channels 2, 3 and 4 = 0
14	Strobe effect	
	0...10	Without function
	11...255	Strobe effect, increasing speed

6.6 Functions in 17-channel DMX mode

Channel	Value	Function
1	0...255	Dimmer (0 % to 100 %)
2	0...255	Intensity red (0 % to 100 %), all segments

Channel	Value	Function
3	0...255	Intensity green (0 % to 100 %), all segments
4	0...255	Intensity blue (0 % to 100 %), all segments
5	0...255	Intensity red (0 % to 100 %), segment 1, if channels 2, 3 and 4 = 0
6	0...255	Intensity green (0 % to 100 %), segment 1, if channels 2, 3 and 4 = 0
7	0...255	Intensity blue (0 % to 100 %), segment 1, if channels 2, 3 and 4 = 0
8	0...255	Intensity red (0 % to 100 %), segment 2, if channels 2, 3 and 4 = 0
9	0...255	Intensity green (0 % to 100 %), segment 2, if channels 2, 3 and 4 = 0
10	0...255	Intensity blue (0 % to 100 %), segment 2, if channels 2, 3 and 4 = 0
11	0...255	Intensity red (0 % to 100 %), segment 3, if channels 2, 3 and 4 = 0
12	0...255	Intensity green (0 % to 100 %), segment 3, if channels 2, 3 and 4 = 0
13	0...255	Intensity blue (0 % to 100 %), segment 3, if channels 2, 3 and 4 = 0
14	Colour selection	
	0...5	Without function

Channel	Value	Function
	6...10	Colour 1
	11...15	Colour 2
	⋮	
	246...250	Colour 49
	251...255	Colour 50
15	Programme selection	
	0...15	Without function
	16...23	Programme 2
	24...31	Programme 3
	⋮	
	216...223	Programme 27
	224...231	Programme 28
	232...255	Sound control

Channel	Value	Function
16	0...255	Process speed of the selected programme, if channel 15 = 16...231
	0...255	Sensitivity of the built-in microphone for the music control, if channel 15 = 232...255
17	Strobe effect	
	0...10	Without function
	11...255	Strobe effect, increasing speed

6.7 Functions in 81-channel DMX mode

Channel	Value	Function
1	0...255	Intensity red (0 % to 100 %), area 1
2	0...255	Intensity green (0 % to 100 %), area 1

Channel	Value	Function
3	0...255	Intensity blue (0 % to 100 %), area 1
4	0...255	Intensity red (0 % to 100 %), area 2
5	0...255	Intensity green (0 % to 100 %), area 2
6	0...255	Intensity blue (0 % to 100 %), area 2
⋮		
79	0...255	Intensity red (0 % to 100 %), area 27
80	0...255	Intensity green (0 % to 100 %), area 27
81	0...255	Intensity blue (0 % to 100 %), area 27

6.8 Functions in 83-channel DMX mode

Channel	Value	Function
1	0...255	Dimmer (0 % to 100 %)
2	0...255	Intensity red (0 % to 100 %), area 1
3	0...255	Intensity green (0 % to 100 %), area 1
4	0...255	Intensity blue (0 % to 100 %), area 1
5	0...255	Intensity red (0 % to 100 %), area 2
6	0...255	Intensity green (0 % to 100 %), area 2
7	0...255	Intensity blue (0 % to 100 %), area 2
⋮		
80	0...255	Intensity red (0 % to 100 %), area 27
81	0...255	Intensity green (0 % to 100 %), area 27
82	0...255	Intensity blue (0 % to 100 %), area 27

Channel	Value	Function
83	Strobe effect	
	0...10	Without function
	11...255	Strobe effect, increasing speed

6.9 Functions in 98-channel DMX mode

Channel	Value	Function
1	0...255	Dimmer (0 % to 100 %)
2	0...255	Intensity red (0 % to 100 %), all segments
3	0...255	Intensity green (0 % to 100 %), all segments
4	0...255	Intensity blue (0 % to 100 %), all segments

Channel	Value	Function
5	0...255	Intensity red (0 % to 100 %), segment 1, if channels 2, 3 and 4 = 0
6	0...255	Intensity green (0 % to 100 %), segment 1, if channels 2, 3 and 4 = 0
7	0...255	Intensity blue (0 % to 100 %), segment 1, if channels 2, 3 and 4 = 0
8	0...255	Intensity red (0 % to 100 %), segment 2, if channels 2, 3 and 4 = 0
9	0...255	Intensity green (0 % to 100 %), segment 2, if channels 2, 3 and 4 = 0
10	0...255	Intensity blue (0 % to 100 %), segment 2, if channels 2, 3 and 4 = 0
11	0...255	Intensity red (0 % to 100 %), segment 3, if channels 2, 3 and 4 = 0
12	0...255	Intensity green (0 % to 100 %), segment 3, if channels 2, 3 and 4 = 0
13	0...255	Intensity blue (0 % to 100 %), segment 3, if channels 2, 3 and 4 = 0
14	0...255	Intensity red (0 % to 100 %), area 1
15	0...255	Intensity green (0 % to 100 %), area 1
16	0...255	Intensity blue (0 % to 100 %), area 1
17	0...255	Intensity red (0 % to 100 %), area 2

Channel	Value	Function
18	0...255	Intensity green (0 % to 100 %), area 2
19	0...255	Intensity blue (0 % to 100 %), area 2
:		
92	0...255	Intensity red (0 % to 100 %), area 27
93	0...255	Intensity green (0 % to 100 %), area 27
94	0...255	Intensity blue (0 % to 100 %), area 27
95	Colour selection	
	0...5	Without function
	6...10	Colour 1
	11...15	Colour 2
	:	
	246...250	Colour 49
	251...255	Colour 50

Channel	Value	Function
96	Programme selection	
	0...15	Without function
	16...23	Programme 2
	24...31	Programme 3
	:	
	216...223	Programme 27
	224...231	Programme 28
	232...255	Sound control
97	0...255	Process speed of the selected programme, if channel 15 = 16...231
	0...255	Sensitivity of the built-in microphone for the music control, if channel 15 = 232...255
98	Strobe effect	

Channel	Value	Function
	0...10	Without function
	11...255	Strobe effect, increasing speed

7 Technical specifications

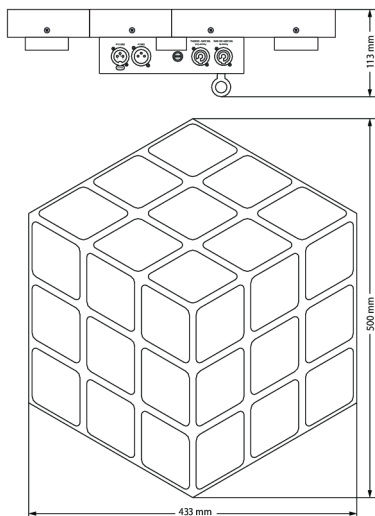

Light source	108 × RGB SMD LED, 0.8 W	
Optical properties	Beam angle	160°
Control	DMX	
	ArtNet	
Number of DMX channels	9, 14, 17, 81, 83, 98	
Input connections	Power supply	Lockable input socket (Power Twist)
	DMX control	XLR chassis socket, 3-pin
Output connections	Power supply	Lockable output socket (Power Twist).
	DMX control	XLR chassis socket, 3-pin
Power consumption	32 W	
Supply voltage	100 - 240 V ~ 50/60 Hz	

Fuse	5 mm × 20 mm, 1 A, 250 V, slow-blow	
Degree of protection	IP20	
Mounting options	Ceiling mounting, wall mounting Quick-lock openings for omega bracket	
Dimensions (W × H × D)	500 mm × 413 mm × 133 mm	
Weight	5.7 kg	
Ambient conditions	Temperature range	0 °C...40 °C
	Relative humidity	20 %...80 % (non-condensing)

Further information

Type	LED panel
Housing colour	Black

8 Plug and connection assignments

Introduction

This chapter will help you select the right cables and plugs to connect your valuable equipment so that a perfect light experience is guaranteed.

Please take our tips, because especially in 'Sound & Light' caution is indicated: Even if a plug fits into a socket, the result of an incorrect connection may be a destroyed DMX controller, a short circuit or 'just' a not working light show!

DMX connections

The unit offers a 3-pin XLR socket for DMX output and a 3-pin XLR plug for DMX input. Please refer to the drawing and table below for the pin assignment of a suitable XLR plug.



Pin	Configuration
1	Ground, shielding
2	Signal inverted (DMX-, 'cold signal')
3	Signal (DMX+, 'hot signal')

9 Troubleshooting



NOTICE!

Possible data transmission errors

For error-free operation make use of dedicated DMX cables and do not use ordinary microphone cables.

Never connect the DMX input or output to audio devices such as mixers or amplifiers.

In the following we list a few common problems that may occur during operation. We give you some suggestions for easy troubleshooting:

Symptom	Remedy
The unit does not work, no light	Check the mains connection.
Apparently no function despite proper power supply	Check if the unit is in DMX mode or in 'slave' mode. If so, check the unit in another mode.
No response to the DMX controller	<ol style="list-style-type: none">1. Check whether the DMX controller is switched on. Check the DMX connectors and cables for proper connection.2. Check the address settings and the DMX polarity.3. Try using another DMX controller.4. Check to see if the DMX cables run near or alongside to high voltage cables that may cause damage or interference to DMX interface circuits.

If the procedures recommended above do not succeed, please contact our Service Center. You can find the contact information at www.thomann.de.

10 Cleaning

Optical lenses

Clean the optical lenses, that are accessible from the outside, regularly in order to optimize the light output. The frequency of cleaning depends on the operating environment: wet, smoky or particularly dirty surroundings can cause more accumulation of dirt on the optics of the device.

- Clean with a soft cloth using our lamp and lens cleaner (item no. 280122).
- Always dry the parts carefully.

11 Protecting the environment

Disposal of the packaging material



For the transport and protective packaging, environmentally friendly materials have been chosen that can be supplied to normal recycling.

Ensure that plastic bags, packaging, etc. are properly disposed of.

Do not just dispose of these materials with your normal household waste, but make sure that they are collected for recycling. Please follow the notes and markings on the packaging.

Disposal of your old device



This product is subject to the European Waste Electrical and Electronic Equipment Directive (WEEE) in its currently valid version. Do not dispose with your normal household waste.

Dispose of this device through an approved waste disposal firm or through your local waste facility. When discarding the device, comply with the rules and regulations that apply in your country. If in doubt, consult your local waste disposal facility.

