



Rackmix 821 FX USB mixer



Musikhaus Thomann
Thomann GmbH
Hans-Thomann-Straße 1
96138 Burgebrach
Germany
Telephone: +49 (0) 9546 9223-0
E-mail: info@thomann.de
Internet: www.thomann.de

24.05.2019, ID: 445450 (V2)

Table of contents

1	General information	4
	1.1 Further information.....	4
	1.2 Notational conventions.....	4
	1.3 Symbols and signal words.....	4
2	Safety instructions	6
3	Features	9
4	Installation and starting up	10
5	Connections and controls	11
6	Technical specifications	15
7	Plug and connection assignment	17
8	Protecting the environment	19

1 General information

This user manual contains important information on the safe operation of the device. Read and follow all safety notes and all instructions. Save this manual for future reference. Make sure that it is available to all persons using this device. If you sell the device to another user, be sure that they also receive this manual.

Our products and user manuals are subject to a process of continuous development. We therefore reserve the right to make changes without notice. Please refer to the latest version of the user manual which is ready for download under www.thomann.de.

1.1 Further information

On our website (www.thomann.de) you will find lots of further information and details on the following points:

Download	This manual is also available as PDF file for you to download.
Keyword search	Use the search function in the electronic version to find the topics of interest for you quickly.
Online guides	Our online guides provide detailed information on technical basics and terms.
Personal consultation	For personal consultation please contact our technical hotline.
Service	If you have any problems with the device the customer service will gladly assist you.

1.2 Notational conventions

This manual uses the following notational conventions:



Letterings

The letterings for connectors and controls are marked by square brackets and italics.

Examples: *[VOLUME]* control, *[Mono]* button.

1.3 Symbols and signal words

In this section you will find an overview of the meaning of symbols and signal words that are used in this manual.

Signal word	Meaning
DANGER!	This combination of symbol and signal word indicates an immediate dangerous situation that will result in death or serious injury if it is not avoided.
CAUTION!	This combination of symbol and signal word indicates a possible dangerous situation that can result in minor injury if it is not avoided.
NOTICE!	This combination of symbol and signal word indicates a possible dangerous situation that can result in material and environmental damage if it is not avoided.
Warning signs	Type of danger
	Warning – high-voltage.
	Warning – danger zone.

2 Safety instructions

Intended use

This device is intended to be used for amplification, mixing and playback of signals from musical instruments and microphones. Use the device only as described in this user manual. Any other use or use under other operating conditions is considered to be improper and may result in personal injury or property damage. No liability will be assumed for damages resulting from improper use.

This device may be used only by persons with sufficient physical, sensorial, and intellectual abilities and having corresponding knowledge and experience. Other persons may use this device only if they are supervised or instructed by a person who is responsible for their safety.

Safety



DANGER!

Danger for children

Ensure that plastic bags, packaging, etc. are disposed of properly and are not within reach of babies and young children. Choking hazard!

Ensure that children do not detach any small parts (e.g. knobs or the like) from the unit. They could swallow the pieces and choke!

Never let children unattended use electrical devices.



DANGER!

Electric shock caused by high voltages inside

Within the device there are areas where high voltages may be present. Never remove any covers.

There are no user-serviceable parts inside.

Do not use the device if covers, protectors or optical components are missing or damaged.



DANGER!

Electric shock caused by short-circuit

Always use proper ready-made insulated mains cabling (power cord) with a protective contact plug. Do not modify the mains cable or the plug. Failure to do so could result in electric shock/death or fire. If in doubt, seek advice from a registered electrician.



CAUTION!

Possible hearing damage

With loudspeakers or headphones connected, the device can produce volume levels that may cause temporary or permanent hearing impairment.

Do not operate the device permanently at a high volume level. Decrease the volume level immediately if you experience ringing in your ears or hearing impairment.



NOTICE!

Risk of fire

Do not block areas of ventilation. Do not install the device near any direct heat source. Keep the device away from naked flames.



NOTICE!

Operating conditions

This device has been designed for indoor use only. To prevent damage, never expose the device to any liquid or moisture. Avoid direct sunlight, heavy dirt, and strong vibrations.

Only operate the device within the ambient conditions specified in the chapter 'Technical specifications' of this user manual. Avoid heavy temperature fluctuations and do not switch the device on immediately after it was exposed to temperature fluctuations (for example after transport at low outside temperatures).

Dust and dirt inside can damage the unit. When operated in harmful ambient conditions (dust, smoke, nicotine, fog, etc.), the unit should be maintained by qualified service personnel at regular intervals to prevent overheating and other malfunction.



NOTICE!

Power supply

Before connecting the device, ensure that the input voltage (AC outlet) matches the voltage rating of the device and that the AC outlet is protected by a residual current circuit breaker. Failure to do so could result in damage to the device and possibly injure the user.

Unplug the device before electrical storms occur and when it is unused for long periods of time to reduce the risk of electric shock or fire.



NOTICE!

Danger of short circuit

Switching on phantom power will damage the device if unbalanced XLR cables are connected.

Only turn on phantom power when exclusively balanced XLR cables are connected.



NOTICE!

Possible staining

The plasticiser contained in the rubber feet of this product may possibly react with the coating of your parquet, linoleum, laminate or PVC floor and after some time cause permanent dark stains.

In case of doubt, do not put the rubber feet directly on the floor, but use felt-pad floor protectors or a carpet.



NOTICE!

Possible damage due to installation of a wrong fuse

The use of different types of fuses can cause serious damage to the unit.
Fire hazard!

Only fuses of the same type may be used.

3 Features

- 8-channel rack mixer with built-in USB audio player and multi-effects unit
- 8 mono channels (MIC, Line, Insert)
- 3-band EQ and pan control
- PFL switch per channel
- 2 AUX ways (1 × FX, 1 × Aux)
- Master output L/R via 2 × XLR and 2 × 1/4" phone socket
- Adjustable headphones output (1/4" phone socket, stereo)
- USB port
- 48 V phantom power, globally switchable
- Built-in power supply

4 Installation and starting up

Unpack and check carefully there is no transportation damage before using the unit. Keep the equipment packaging. To fully protect the product against vibration, dust and moisture during transportation or storage use the original packaging or your own packaging material suitable for transport or storage, respectively.

Before connecting the operating voltage and before connecting or disconnecting audio cables, set all volume controls of the unit to zero to avoid damage to the connected speakers and devices.



NOTICE!

Possible staining

The plasticiser contained in the rubber feet of this product may possibly react with the coating of your parquet, linoleum, laminate or PVC floor and after some time cause permanent dark stains.

In case of doubt, do not put the rubber feet directly on the floor, but use felt-pad floor protectors or a carpet.

5 Connections and controls

Mono channel strips

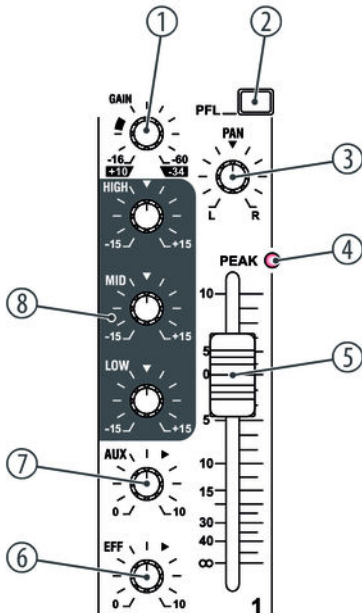

1	[GAIN] Rotary control to adjust the input level
2	[PFL] With this switch pressed, the channel signal is unaffected by the setting of the channel fader and the internal effects section and present at the output [PHONES]. The switch does not affect the signal at the outputs [MAIN OUT] and [REC OUT].
3	[PAN] Rotary control for positioning the channel signal within the stereo panorama
4	[PEAK] The LED lights up on channel overload. If this happens, turn the control [GAIN] to the left until this LED is extinguished.
5	The channel fader sets the strength of the channel signal in the overall signal.
6	[EFF] Rotary control to adjust the signal portion to be sent to the output [FX SEND] and to the built-in effects unit.
7	[AUX] Rotary control to adjust the signal portion to be sent to the output [AUX SEND] to e.g. create a monitor mix.
8	3-band EQ for treble [HIGH], mids [MID] and lows [LOW].

Main and effects section, USB

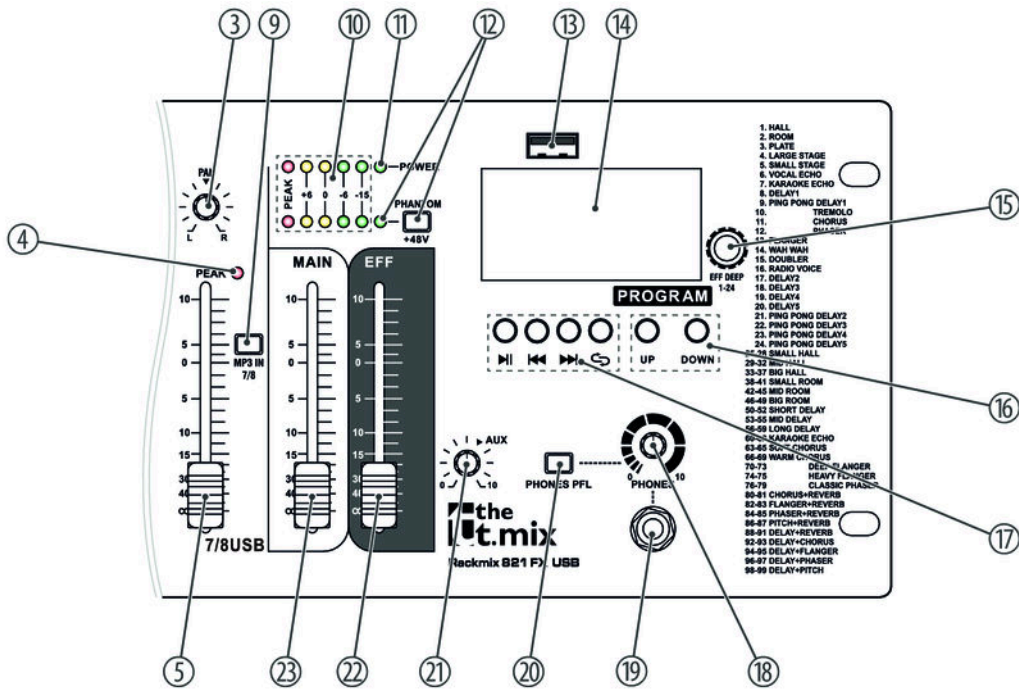

9	[MP3 IN 7/8]	Switches the signal source for channels 7 and 8 between the audio player and the inputs [R/MONO] / [L] on the rear panel.
10		These LED chains indicate the level of the sum signal. Keep the level within a range below +18. The red LEDs indicates overload. In this case, pull back the two master faders so that the red LEDs do not light up any more.
11	[POWER]	This LED shows that the unit is turned on.
12	[PHANTOM]	When this switch is in ON position, a phantom voltage of 48 V $\overline{\text{---}}$ is present at the XLR sockets in the mono channels for using condenser mics. If no condenser mics are used, the switch should be in the OFF position. The phantom voltage must not be switched on if an unbalanced XLR cable is connected to one of the MIC inputs. The LED is lit when the phantom power is on.
13		USB port for connecting data media for playback of MP3 or WAV files.
14		The left half of this display shows the contents of a connected MP3 player. The number of the selected effect is displayed in the right half.
15	[EFF DEEP 1-24]	Rotary control to fine tune specific parameters of the currently selected effect.
16	[PROGRAM][UP] / [DOWN]	Buttons to select the desired effect, see imprinted list. To select an effect, press [UP] or [DOWN] repeatedly until the display shows the desired number.

17	These buttons are used to operate the built-in audio player. ▶ : Pause / Playback ◀◀: Previous track ▶▶: Next track ↻: Operating mode selection
18	<i>[PHONES]</i> Volume control for headphone output
19	Stereo headphones output
20	<i>[PHONES PFL]</i> Switches the signal source for the headphone output between the MAIN signal (switch not pressed) or those input channels that have pre-fader listening activated with the <i>[PFL]</i> .
21	<i>[AUX]</i> Rotary control to adjust the overall level at the output <i>[EFF SEND]</i>
22	<i>[EFF]</i> Fader to adjust the effects portion in the overall signal.
23	<i>[STEREO]</i> Master fader to adjust the sum level at the output <i>[MAIN]</i>

Rear panel

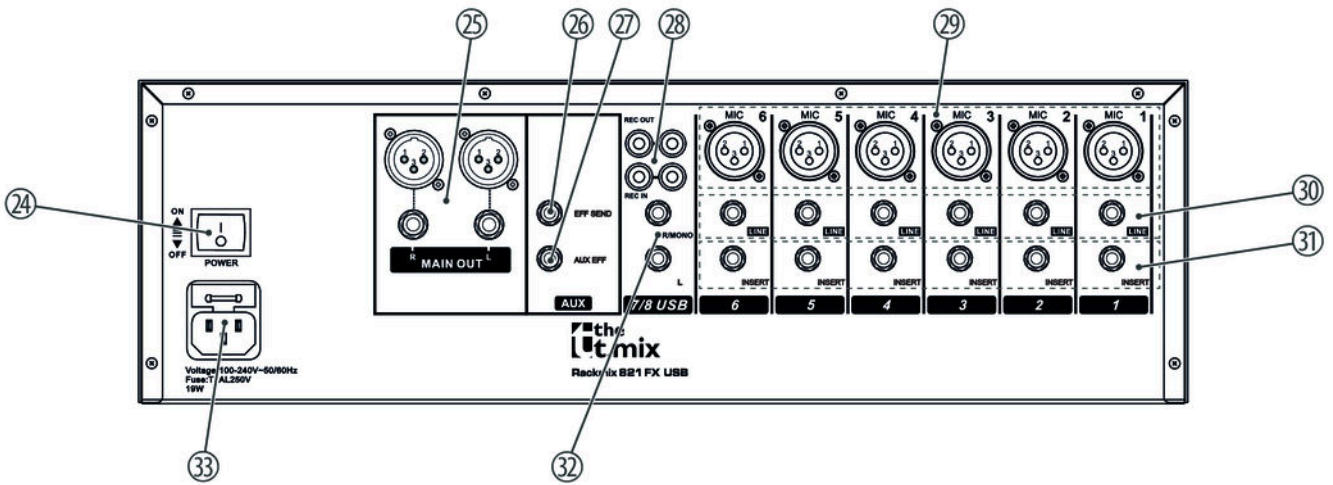

24	[ON OFF] Mains switch to turn the device on or off.
25	[MAIN OUT] Balanced 1/4" phone and XLR outputs for connecting power amplifiers, effects or recording devices.
26	[EFF SEND] 1/4" phone socket, usable, for example, for connecting external effects units. At this output, the signal controlled by the fader [EFF].
27	[AUX EFF] 1/4" phone socket, usable, for example, for connecting a monitor speaker. At this output, the signal controlled by the rotary control [AUX] is present.
28	[REC OUT] RCA connections (left and right), for example for an external recording device [REC IN] RCA connections (left and right), for example for an external player
29	[MIC] Balanced XLR mono inputs to connect each one microphone
30	[LINE] 1/4" phone input to connect a line level audio source (keyboards, drum modules etc., balanced or unbalanced)
31	[INSERT] 1/4" phone input to insert external units into the signal path of the respective channel
32	[R/MONO] / [L] Line level input for connecting external audio devices, e.g. signal processors, designed as a 1/4" phone socket.
33	IEC chassis plug for power supply with fuse holder.

6 Technical specifications

Input connections	Power supply	IEC chassis plug C14
	Line input	8 × 1/4" jack socket
	INSERT	6 × 1/4" jack socket
	REC IN	2 × RCA socket
	Mic input	6 × XLR chassis socket, 3-pin
	USB port	USB 3.0
Output connections	Main Out	2 × 1/4" phone socket, balanced
		2 × XLR chassis socket, 3-pin
	AUX	2 × 1/4" phone socket, balanced
	REC OUT	2 × RCA socket
	Headphones	1 × 1/4" jack socket
Max. output level	Main	Balanced: +28 dBu
		Unbalanced: +22 dBu
	AUX SEND, REC OUT	Unbalanced: +22 dBu
	Headphones output	+15 dBu / 150 mW
Frequency response	MIC input	10 Hz ... 200 kHz
	Line input	10 Hz ... 130 kHz
Signal-to-noise ratio	MIC input	120 dB E.I.N.
	Line input	95 dB E.I.N.
Signal gain	Mic input	14 dB ... 60 dB
	Line input	-6 dB ... 38 dB
Input level	Mic input	+4 dBu ± 1 dBu max.
	Stereo line input	+21 dBu ± 1 dBu max.
Sound control	Treble	10 kHz, ± 15 dB
	Mids	50 Hz, ± 15 dB
	Bass	700 Hz, ± 10 dB
Effects	33 in total	
Phantom power	48 V	
Power consumption	19 W	
Supply voltage	100 – 240 V ~ 50/60 Hz	
Fuse	5 mm × 20 mm, 1.6 A, 250 V, slow-blow	

Technical specifications

Installation	19", 3 RU	
Dimensions (W × H × D)	485 mm × 140 mm × 175 mm	
Weight	4.5 kg	
Ambient conditions	Temperature range	0 °C...40 °C
	Relative humidity	50 %, non-condensing

Further information

Number of microphone inputs	6
Number of line inputs	8
Rack units	3

7 Plug and connection assignment

Introduction

This chapter will help you select the right cables and plugs to connect your valuable equipment in such a way that a perfect sound experience is ensured.

Please note these advices, because especially in 'Sound & Light' caution is indicated: Even if a plug fits into the socket, an incorrect connection may result in a destroyed power amp, a short circuit or 'just' in poor transmission quality!

Balanced and unbalanced transmission

Unbalanced transmission is mainly used in semi-professional environment and in hifi use. Instrument cables with two conductors (one core plus shielding) are typical representatives of the unbalanced transmission. One conductor is ground and shielding while the signal is transmitted through the core.

Unbalanced transmission is susceptible to electromagnetic interference, especially at low levels, such as microphone signals and when using long cables.

In a professional environment, therefore, the balanced transmission is preferred, because this enables an undisturbed transmission of signals over long distances. In addition to the conductors 'Ground' and 'Signal', in a balanced transmission a second core is added. This also transfers the signal, but phase-shifted by 180°.

Since the interference affects both cores equally, by subtracting the phase-shifted signals, the interfering signal is completely neutralized. The result is a pure signal without any noise interference.

1/4" TS phone plug (mono, unbalanced)



1	Signal
2	Ground, shielding

1/4" TRS phone plug (mono, balanced)



1	Signal (in phase, +)
2	Signal (out of phase, -)
3	Ground

1/4" TRS phone plug (stereo, unbalanced)



1	Signal (left)
2	Signal (right)
3	Ground

XLR plug (balanced)

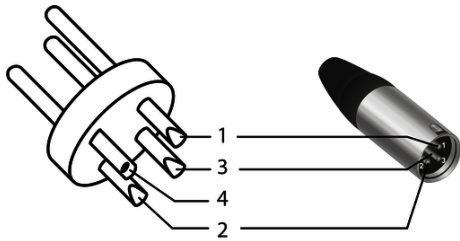

1	Ground, shielding
2	Signal (in phase, +)
3	Signal (out of phase, -)
4	Shielding on plug housing (option)

XLR plug (unbalanced)

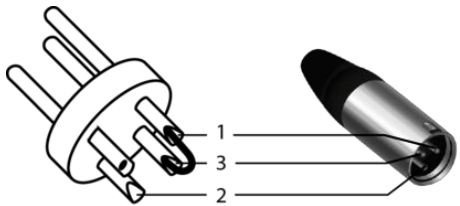

1	Ground, shielding
2	Signal
3	Bridged to pin 1

RCA connection



Drawing and table indicate the pin assignment of an RCA plug.

1	Signal
2	Ground, shielding

8 Protecting the environment

Disposal of the packaging material



For the transport and protective packaging, environmentally friendly materials have been chosen that can be supplied to normal recycling.

Ensure that plastic bags, packaging, etc. are properly disposed of.

Do not just dispose of these materials with your normal household waste, but make sure that they are collected for recycling. Please follow the notes and markings on the packaging.

Disposal of your old device



This product is subject to the European Waste Electrical and Electronic Equipment Directive (WEEE) in its currently valid version. Do not dispose with your normal household waste.

Dispose of this device through an approved waste disposal firm or through your local waste facility. When discarding the device, comply with the rules and regulations that apply in your country. If in doubt, consult your local waste disposal facility.

