

DRAWMER



CMC3 MONITOR CONTROLLER

CONTENTS

Warranty	3
Safety Consideration	3
Radio Frequencies Statement	3
<i>Chapter 1 - Introduction</i>	
Introduction	4
Installation	6
Power Connection	7
Security	7
Audio Connection	8
Typical Connection Guide.	9
<i>Chapter 2 - Control Description</i>	
Control Description	10
Mix Checking Tips.	16
<i>Chapter 3 - General Information</i>	
If a fault develops	19
Contacting Drawmer	19
Specification	19
Block Diagram	20

COPYRIGHT

This manual is copyrighted © 2018 by Drawmer Electronics Ltd. With all rights reserved. Under copyright laws, no part of this publication may be reproduced, transmitted, stored in a retrieval system or translated into any language in any form by any means, mechanical, optical, electronic, recording, or otherwise, without the written permission of Drawmer Electronics Ltd.

ONE YEAR LIMITED WARRANTY

Drawmer Electronics Ltd., warrants the Drawmer **CMC3 Monitor Controller** to conform substantially to the specifications of this manual for a period of one year from the original date of purchase when used in accordance with the specifications detailed in this manual. In the case of a valid warranty claim, your sole and exclusive remedy and Drawmer's entire liability under any theory of liability will be to, at Drawmer's discretion, repair or replace the product without charge, or, if not possible, to refund the purchase price to you. This warranty is not transferable. It applies only to the original purchaser of the product.

For warranty service please call your local Drawmer dealer. Alternatively call Drawmer Electronics Ltd. at +44 (0)1709 527574. Then ship the defective product, with transportation and insurance charges pre-paid, to Drawmer Electronics Ltd., Coleman Street, Parkgate, Rotherham, S62 6EL UK. Write the RA number in large letters in a prominent position on the shipping box. Enclose your name, address, telephone number, copy of the original sales invoice and a detailed description of the problem. Drawmer will not accept responsibility for loss or damage during transit.

This warranty is void if the product has been damaged by misuse, modification, unauthorised repair or installed with other equipment that proved to be faulty.

THIS WARRANTY IS IN LIEU OF ALL WARRANTIES, WHETHER ORAL OR WRITTEN, EXPRESSED, IMPLIED OR STATUTORY. DRAWMER MAKES NO OTHER WARRANTY EITHER EXPRESS OR IMPLIED, INCLUDING, WITHOUT LIMITATION, ANY IMPLIED WARRANTIES OF MERCHANTABILITY, FITNESS FOR A PARTICULAR PURPOSE, OR NON-INFRINGEMENT. PURCHASER'S SOLE AND EXCLUSIVE REMEDY UNDER THIS WARRANTY SHALL BE REPAIR OR REPLACEMENT AS SPECIFIED HEREIN.

IN NO EVENT WILL DRAWMER ELECTRONICS LTD. BE LIABLE FOR ANY DIRECT, INDIRECT, SPECIAL, INCIDENTAL OR CONSEQUENTIAL DAMAGES RESULTING FROM ANY DEFECT IN THE PRODUCT, INCLUDING LOST PROFITS, DAMAGE TO PROPERTY, AND, TO THE EXTENT PERMITTED BY LAW, DAMAGE FOR PERSONAL INJURY, EVEN IF DRAWMER HAS BEEN ADVISED OF THE POSSIBILITY OF SUCH DAMAGES.

Some states and specific countries do not allow the exclusion of implied warranties or limitations on how long an implied warranty may last, so the above limitations may not apply to you. This warranty gives you specific legal rights. You may have additional rights that vary from state to state, and country to country.

For the USA

FEDERAL COMMUNICATIONS COMMISSION RADIO FREQUENCY INTERFERENCE STATEMENT

This equipment has been tested and found to comply with the limits for a Class B digital device, pursuant to Part 15 of the FCC Rules. These limits are designed to provide reasonable protection against harmful interference in a residential installation. This equipment generates, uses and can radiate radio frequency energy and, if not installed and used in accordance with the instructions, may cause harmful interference to radio communications. However, there is no guarantee that interference will not occur in a particular installation. If this equipment does cause interference to radio or television reception, which can be determined by turning the equipment off and on, then the user is encouraged to try to correct the interference by one or more of the following measures:

Re-orient or relocate the receiving antenna.

Increase the separation between the equipment and the receiver.

Connect the equipment into an outlet on a circuit different from that to which the receiver is connected.

Consult the dealer or an experienced radio/TV technician for help.

Unauthorised changes or modification to this system can void the users' authority to operate this equipment. This equipment requires shielded interface cables in order to meet FCC class B limit.

For Canada

CLASS B NOTICE

This digital apparatus does not exceed the Class B limits for radio noise emissions set out in the Radio Interference Regulations of the Canadian Department of Communications.

CLASSE B AVIS

Cet appareil numérique ne dépasse pas les limites de la classe B au niveau des émissions de bruits radioélectriques fixés dans le Règlement des signaux parasites par le ministère Canadien des Communications.

SAFETY CONSIDERATIONS

CAUTION - SERVICING

DO NOT OPEN. REFER ALL SERVICING TO QUALIFIED SERVICE PERSONNEL.

WARNING

TO REDUCE RISK OF FIRE/ELECTRIC SHOCK DO NOT EXPOSE THIS EQUIPMENT TO MOISTURE.

WARNING

DO NOT ATTEMPT TO CHANGE OR TAMPER WITH THE SUPPLIED MAINS CABLES.

WARNING

THERE ARE NO USER REPLACEABLE FUSES WITHIN EITHER THE CMC3 OR IT'S SUPPLIED POWER SUPPLY. IF FOR ANY REASON THE CMC3 CEASES TO WORK DO NOT ATTEMPT TO MEND IT - CONTACT DRAWMER TO ARRANGE FOR A REPAIR/REPLACEMENT.

In the interests of product development, Drawmer reserve the right to modify or improve specifications of this product at any time, without prior notice.

CMC3 Monitor Controller

FULLY FEATURED MONITOR CONTROLLER FOR STUDIOS OF ALL SIZES.
PRECISE, COMPACT & AFFORDABLE.

The CMC3 Compact Monitor Controller consolidates the feature sets of Drawmer's 3 most popular monitor controllers: Whilst retaining the famed accurate, and transparent audio quality of the MC2.1, it has the precision and control of the MC3.1 and the low profile, compact design of the CMC2. It is equally at home in a serious home studio as in a professional recording facility.



Accurate & Transparent

With the same Drawmer pedigree as the MC2.1, the CMC3 circuit is just as transparent and accurate. It has been designed to remove the limitations that a passive circuit brings, such as the ability to increase the volume for quiet passages and improved mix checking, without adding the artifacts that lesser quality active circuits introduce. You hear exactly what you've recorded!

Precision

The CMC3 supports 3 sets of stereo monitors, plus a dedicated mono speaker/sub-woofer output, each can be switched individually and simultaneously and in any order, especially useful for A/B comparisons. You can listen to multiple speakers with the same sub-woofer, or turn the sub-woofer off altogether.

The volume control utilizes a paralleled custom quad pot for excellent channel matching and smooth feel, as does the secondary preset volume control on the front. This provides repeatable calibrated output level for the monitors, so that at the flick of a switch the engineer can hear the mix at the same predetermined volume, time after time, without having to meticulously adjust controls.

Multiple Connections

The CMC3 is very well connected with 4 stereo inputs in total: 1x SPDIF digital input (24 bit/192kHz), using the same DAC chipset as our established MC3.1 monitor controller, 2 stereo balanced jack inputs, plus a 3.5mm jack with variable level control for your Smartphone/MP3 Player.

In addition, it has a 2 professional quality headphone outputs with a separate amplifier and level control, that provide the same audio quality and mix checking as the CMC3 does through the speakers. Talkback is also included with internal or external microphone, level control and audio routing to a dedicated mono output jack & headphones.

Advanced Mix Checking

The comprehensive mix checking facilities of the CMC3 include dim, mono, phase reverse, left and right cut as well as an easy access mute switch, allowing you to check the quality of your recordings: tune into your mix to hear any unwanted artefacts, test the effectiveness of the stereo mix, check for phase cancellation, listen to the stereo difference. Features that many monitor controllers lack.

Main Features:

- Ultra low noise and transparent circuit design.
- Source switches can be active in any combination. 4 Inputs in Total - 1x Digital SPDIF (192 kHz / 24 Bit) & 2 on balanced analogue 1/4" jacks & 1 3.5mm Front Panel Aux jack for your Smartphone/MP3.
- 3x Speakers Plus a Mono Sub can be switched individually & simultaneously or give A/B comparisons.
- Timed relay protection on all speaker outputs to prevent power up/down bangs.
- Volume can be set via the Variable Front Panel Knob or a Preset Control. Each has paralleled custom quad pots for excellent channel matching and smooth feel.
- 2x Headphone Amplifiers with Individual Level Controls with easy access to the jacks on the front.
- Front Panel 3.5mm AUX Input & Level Control for connecting MP3 player, smartphone or tablet etc.
- Built In Talkback with Level Control, Internal or External Microphone, and Internal Routing to a Mono Output Jack & Headphones.
- Comprehensive Mix Checking facilities Include Dim, Phase Reverse and Mono, Left and Right Cut as well as an easy access Mute switch.
- Kensington security slot (also called a K-Slot or Kensington lock).
- Very low profile desktop enclosure with a footprint of just 18x16cm.
- Stylish and Rugged Enclosure will withstand the knocks of the studio.
- Designed and manufactured by Drawmer in the UK.

INSTALLATION

The CMC3 is a free standing, desktop unit. We have endeavoured to make the CMC3 as small as possible without compromising on controls, connections and above all sound quality. The unit has a footprint of just 27cm x 16cm with controls on the top, headphone and mp3/phone input on the front and all other connections on the rear panel.

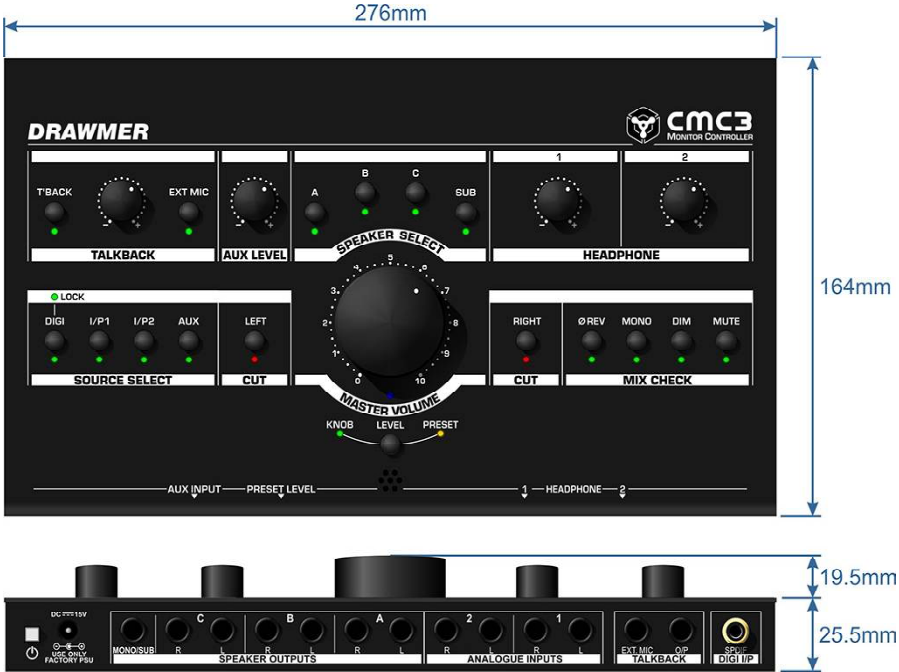

POWER CONNECTION

The CMC3 unit will be supplied with an external switching mode power supply that is capable of 100-240Vac continuous (90-264Vac max) and so should work globally. We strongly advise that the power supply that has been supplied with the CMC3 is used, rather than one with the equivalent ratings. In addition, should the power supply fail for any reason we strongly advise that you contact Drawmer for a replacement rather than repairing the unit yourselves. Failure to do either of these could permanently damage the CMC3 and will also invalidate the warranty.

The power supply will be supplied with 4 interchangeable AC pins for the UK, European, USA and Australian socket types. For your own safety, it is important that you use the correct adapter. The power supply must not be tampered with or modified.

Before connecting the CMC3 to the power supply ensure that all knobs are turned off (i.e. fully anticlockwise). A switch next to the d.c. power inlet on the rear of the unit switches the power on/off.

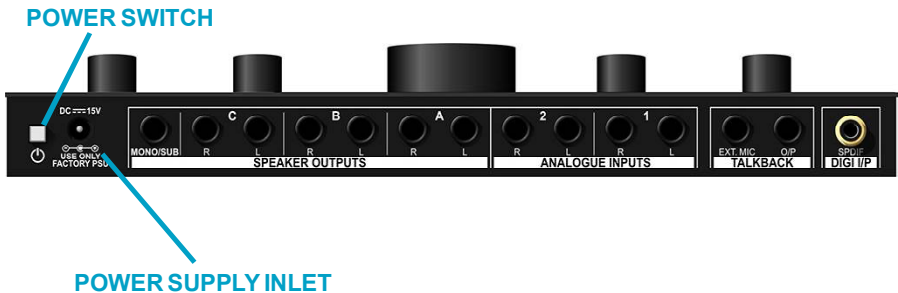

SECURITY

To help protect the CMC3 from theft the side has a Kensington Security Slot (also called a K-Slot) which enables the fitting of hardware locking accessories that can attach your CMC3 to an immovable object, making the CMC3 more of a challenge for the potential thieves to steal.

AUDIO CONNECTIONS

1/4" JACK - BALANCED MONO

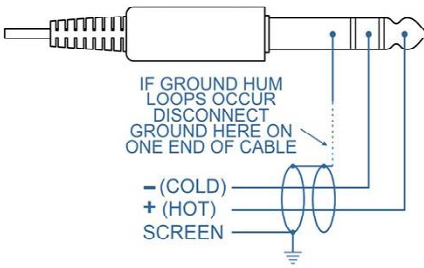

1/4" STEREO HEADPHONE JACK

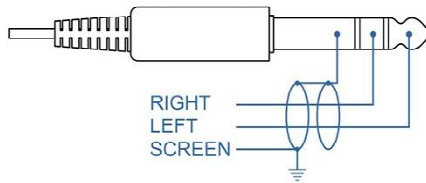

3.5mm STEREO AUX JACK

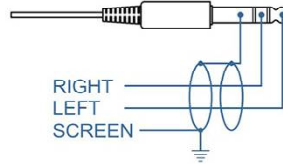

DIGITAL S/PDIF RCA JACK

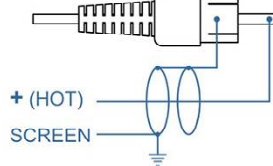

1/4" TALK BACK JACK - UNBALANCED MONO

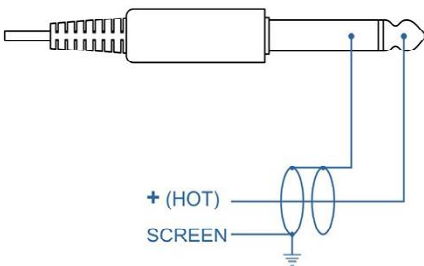

- **Interference:**
If the unit is to be used where it maybe exposed to high levels of disturbance such as found close to a TV or radio transmitter, we advise that the unit is operated in a balanced configuration. The screens of the signal cables should be connected to the chassis connection on the XLR connector as opposed to connecting to pin1. The CMC3 conforms to the EMC standards.

- **Ground Loops:**
If ground loop problems are encountered, never disconnect the mains earth, but instead, try disconnecting the signal screen on one end of each of the cables connecting the outputs of the CMC3 to the patchbay. If such measures are necessary, balanced operation is recommended.

Cable Wiring for TalkBack Output (Mono) to Stereo Distribution

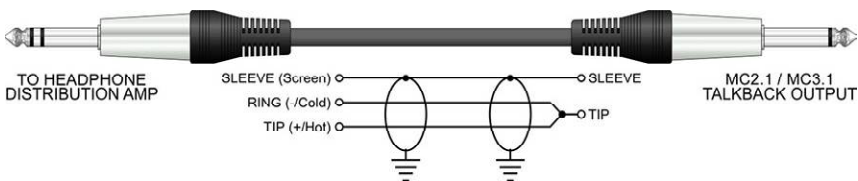

TYPICAL CONNECTION GUIDE

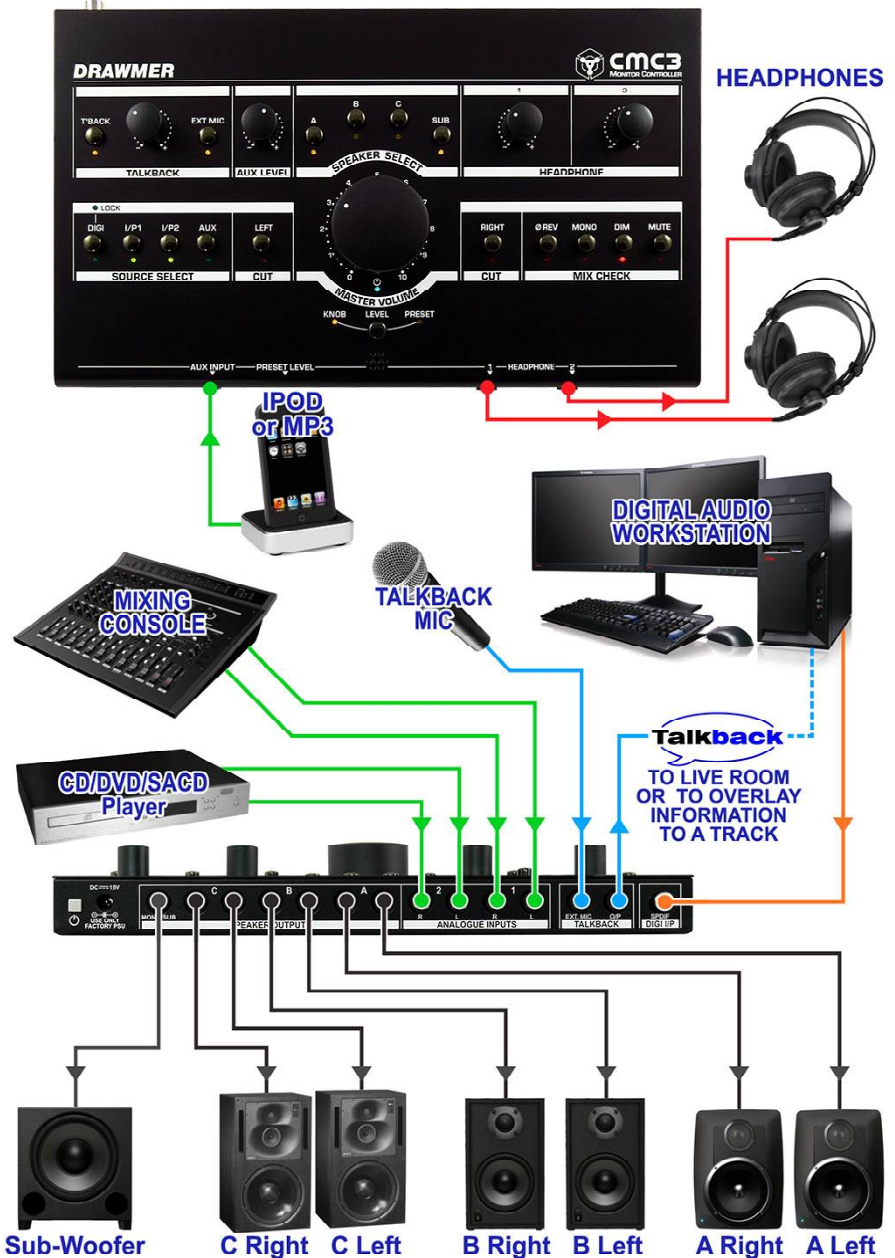

CONTROL DESCRIPTION

As well as a transparent and precise signal path the CMC3 Compact Monitor Controller incorporates many impressive features which are invaluable to the sound engineer when listening to and examining the quality of the audio.

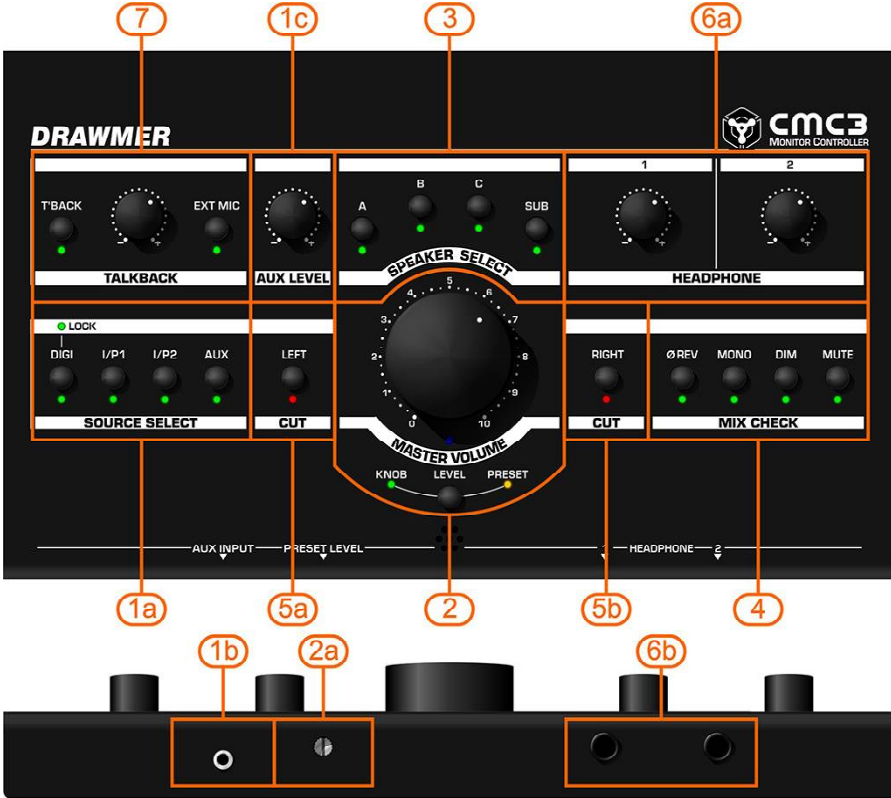

1 SOURCE SELECT

Four switches select which of the analogue inputs - **I/P1**, **I/P2** (9) and **AUX** (1b), and digital input - **DIGI** (8), are heard at the Speaker Outputs (10) and Headphones (6b). Each can be operated individually or simultaneously and in any combination. When operated simultaneously the individual signals are summed into a single stereo signal. Note that the CMC3 does not provide individual level trims for the **I/P1**, **I/P2** and **DIGI** inputs and so any level matching should be applied before it reaches the CMC3.

The digital DAC converts up to 192kHz/24 Bit and is via **SPDIF** (8) phono socket located on the rear. A **LOCK** led above the switch shows when the signal is strong and the CMC3 is locked in, if not lit the digital signal should be checked.

An **AUX** 3.5mm stereo jack input is located on the front panel (1b) to allow easy access to connect a MP3 player, smartphone or similar audio device. A control knob (1c) allows the adjustment of the **AUX** volume to match the system level.

2 MASTER VOLUME

The Monitor Volume control (2) adjusts the signal level of both stereo channels for all speaker outputs. The Volume knob affects the volume of the monitors A,B,C and SUB only and does not have a bearing on any other output such as the headphones or talkback jack.

A secondary preset volume control on the front edge (2a) provides a repeatable calibrated output level for the monitors, so that at the press of the switch just below the main volume knob the engineer can hear the mix at the same predetermined volume, time after time, without having to meticulously adjust controls. Once the system is calibrated the predetermined level could be set via a screwdriver to the maximum listening level, 85dB in the case of TV, film and music, for example, or to a standard listening level for radio, or even a preferred level for quiet passage. The level chosen is at the discretion of the operator.

Both the volume knob and preset control circuit designs incorporate identical paralleled custom quad potentiometers, for excellent channel matching and a smooth feel, with a range from Off (-infinity) to +6dB of gain.

Because the circuitry is active it allows for the signal level to be increased, rather than only attenuated, making subtle problems within the mix (such as noise at low levels, or unwanted harmonics, for example) more obvious and easier to iron out, especially during musical passages that would normally be quiet.

Before you can make full effective use of the Volume control it is necessary to calibrate the entire monitoring system, this allows for accurate level control, as well as left/right balance throughout the knob's range. Note that the actual output levels, including the maximum output level and the position of unity gain (0dB) around the knob, will alter depending on the calibration of the monitors.

WARNING:

It is recommended that you turn the volume control down to a lower level before turning the CMC3 off - this is to ensure that a sudden volume increase when turning on does not damage your speakers or your hearing.

In addition, do not use excessive force at either end of the volume knob - it's size would mean that damaging the potentiometer is possible.

Note that on the underside of the CMC3 there are 2 rotary controls that allow the left and right speaker level of all of the Speaker Outputs (10) to be trimmed. If the input levels into the CMC3 are very high the operator will find that the optimum location of the volume knob (i.e. 85dB output level) would be at around 9 o'clock or worse - leaving them with only a few degrees of rotation in which to lower the volume. By adjusting the trims underneath this can be improved to give the preferred listening level to somewhere more useful, such as the 12 o'clock position. This is especially useful for those studios who work at high gain levels, allowing them to come into the CMC3 'hot'.

To alter the speaker level trims use a small screwdriver to turn - counter-clockwise turns the speaker level down, and clockwise up.

DRAWMER

3 SPEAKER SELECT

Four switches select which of the four speaker outputs **A**, **B**, **C** or **SUB** are heard (10).

Each switch can be operated individually or simultaneously and in any combination and is perfect for performing A/B comparisons between various monitor setups. As the switches do not toggle between outputs when doing A/B comparisons both of those switches should be pressed at the same time i.e. to compare speakers A and C, with A active press both the A and C switches to swap the output to C active, and then again to return to the previous setting - this method can be used between all four outputs if required.

An additional benefit is derived when using a sub-bass. If the sub-bass is attached to the SUB/MONO output on the rear of the MC3.1, outputs A and B could deliver the higher frequencies and allow for A/B (or in this case A+Sub/B+Sub) comparisons between the two monitor setups by pressing the A and B switches simultaneously and leaving SUB always active. In addition, a full frequency range monitor could be attached to C, so, with the C switch active SUB should be disengaged.

4 MIX CHECKING

The **Mix Checking** section allows the engineer to test various aspects of the mix without having to alter the signal earlier in the chain and potentially effect the recording, and is a very thorough and versatile checking tool. The switches are especially useful when used in conjunction with each other.

Phase Reverse: Inverts the polarity of the signal on the Left Channel and is used primarily to outline any phase problems that may be occurring in the mix/recording such as phase cancellation, or an unbalanced stereo signal. As the switch is toggled any phase issues will become more apparent and easier to identify.

Mono: With the switch active both Left and Right stereo signals are combined into a single mono signal.

It is necessary when testing the audio to not only listen to the signal in stereo but also in mono. It helps to outline problems in the mix, but also when testing for use on non-standard applications such as for broadcast or mobile phone.

Dim: With the switch active the output level is attenuated by 20dB's. It enables you to lower the volume without adjusting any of the settings.

Mute: Cuts the level of both channels and is especially useful in an emergency. If Left Cut and Right Cut are both active it is just the same as Mute being active.

Note that **Mute** does not affect the headphones (6a, 6b) in the same way as it does the speakers (10). With the **Mute** switch active the headphones will still pass audio in just the same way as if it was off, they are not affected. This allows for someone to edit audio using headphones whilst a conversation is occurring in the control room, for example.

5 CUT

Left Cut (5a): Mutes the Left channel signal allowing only the right signal to be heard,

Right Cut (5b): Mutes the Right channel signal allowing only the left signal to be heard,

Note that the left and right **Cut** do have an influence on both the speaker outputs and the headphones.

When activating **Left** or **Right Cut** whilst using headphones the signal is not 100% panned one way or the other - i.e. the signal centre moves to the side but is not completely removed from the opposite ear of the headphone - this is so that the **Left/Right Cut** sounds a little more natural, after all, if listening through speakers with only the left speaker active some of the signal will reach the right ear a few milliseconds later.

6 HEADPHONE

The CMC3 has two dedicated headphone amplifiers with outputs, via 1/4" TRS jacks, on the front face (**6b**) and level control (**6a**) on the front face - Note that the level control is not affected by the main large monitor volume knob (**2**), and have no bearing on volume of the rear panel outputs (**10**).

Warning:

It is advisable to unplug the headphones before switching the CMC3 on or off.

It is also recommended that you turn the headphone level down before inserting the jack, and turn it up to your desired listening level - these measures will not only prevent your ears from being damaged but also the headphone's drivers. Also, note that these are high quality circuits and have been designed for professional headphones, so care must be taken when using lower standard, consumer quality headphones as damage could occur.

7 TALKBACK

The MC3.1 has a dedicated talkback function including inbuilt microphone, external microphone port and gain level control.

External Mic Switch: When active disengages the inbuilt front panel microphone and routes the operator's voice through an external microphone (not supplied), which is plugged into the rear panel (**11**).

Talkback Active Switch: When active engages either the inbuilt or external microphone and routes the operator's voice through the headphones and also to the talkback output on the rear of the unit (**11**). The switch is non-latching and so must be held in to be active.

Talkback Level. The knob adjusts the gain level of the talkback microphone. It can be adjusted to compensate for the distance that the operator is from the microphone, how loud his voice is, or the volume of the underlying music played, as well as several other factors.

TalkBack Microphone. An electret condenser microphone has been incorporated into the CMC3 and is located below the Volume controls in the bottom centre of the front panel.

Activating the Talkback automatically engages the Dim switch (i.e. attenuates the volume by 20dB) for the headphones (**6**) and also the speaker outputs (**10**) making it possible for the artist to clearly hear the instruction.

As well as the headphones the talkback signal is also routed to the direct talkback output jack on the rear of the unit (**11**) to be routed at the engineers discretion.

DRAWMER

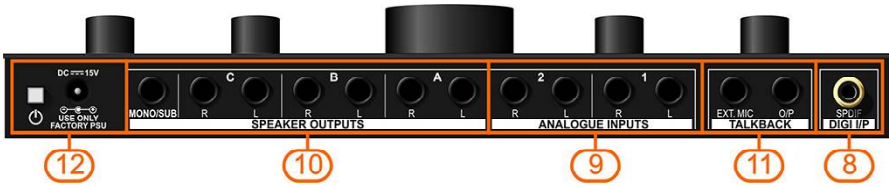

8 DIGITAL INPUT

In addition to the three analogue inputs the CMC3 a dedicated DAC has been incorporated into the CMC3, capable of converting incoming sample rates up to 192kHz at a word length of 24 Bit

The SPDIF is via 75 ohm cable with a phono socket, where the data conforms to the Sony™ Phillips™ Digital InterFace format. Because this connector only provides an unbalanced termination, the recommended maximum length for this cable is 3 metres, even with very high quality cable.

Activate the input via the input source section **(1a)**.

9 ANALOGUE INPUTS

The CMC3 has three analogue inputs comprising **I/P1 & I/P2** - both balanced ¼" phone jacks, on the rear panel, and also **AUX.** - a 3.5mm stereo jack found on the front panel (see **(1b)** & 'Audio Connections'). Activate the inputs via the input source section **(1a)**.

10 SPEAKER OUTPUTS

Three stereo balanced speaker outputs- **A, B** and **C**, plus a dedicated mono speaker/sub-woofer output - **SUB/MONO** - are found on the rear of the unit, all in the form of balanced ¼" phone jacks.

Each output is activated by the **Speaker Select** switches on the front **(3)** - and can be activated individually or simultaneously and in any configuration.

11 TALKBACK

External Microphone and **Talkback Output** connectors can be found on the rear panel, in the form of ¼" jacks.

External Microphone: An external microphone can be connected to provide a more convenient location for the talkback. It is amplified by the inbuilt preamp circuitry with the volume level controlled via the Talkback Volume knob **(7)**, however, phantom power is not supplied so a dynamic microphone should be used. To operate set the **EXT MIC** switch **(7)** to active - this will bypass the CMC3 onboard mic.

Talkback Output: A dedicated ¼" mono talkback output jack can be found on the rear panel, so that, as well as being routed through the headphones, a talkback signal can be routed to other devices at the engineers discretion. This could usually be patched into the live-room active monitor speakers for convenience when recording acoustic ensembles where the performers may not wish or need to wear headphones. It could also be used as an added channel on a mixing desk to be patched into a multiple headphone amplifier along with the stereo mix, for example. The jack also allows for routing into a separate channel of a DAW, or other recording facility, to allow for information overdubs to be added to a recording.

To connect the mono talkback to a Dual Mono jack use the following cable wiring:

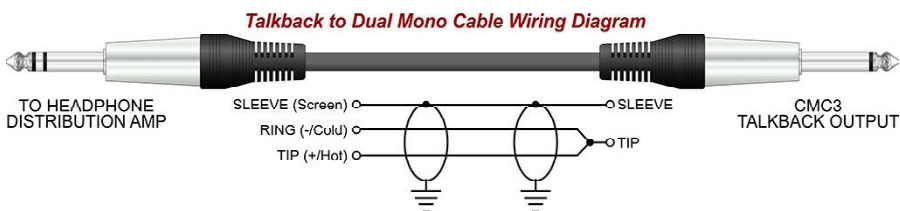

12 POWER

The CMC3 will be supplied with an external switching mode power supply that is capable of 100-240Vac continuous (90-264Vac max) and should work globally, but is supplied with a cable suitable for domestic power outlets in your country. We strongly advise that the power supply that has been supplied with the CMC3 is used, rather than one with the equivalent ratings. The push button switch activates the CMC3. Note that a timed relay protection circuit has been incorporated into circuit to prevent bangs and other potentially harmful artifacts from occurring during power up and power down.



Mix Checking Tips

Due to the versatility of the CMC3 some very useful techniques for checking your mix can easily be achieved, that can help improve the balance within a mix, pinpoint stereo width, phase and mono problems, and also aid when monogising.

The following are a few handy tips to help eradicate problems and bring about a balance within the mix:

Not too loud...

Give your ears a break. Do not have the volume too loud - frequent monitoring at anything above 90dB will only make your ears tired, meaning that you won't really hear the problems that may be occurring, and give you a false sense that the mix sounds nice and loud. Also, constant listening at anything above 100dB will probably have a long term detrimental effect on your hearing.

Shhhh...

Get into a habit of listening to your mix at very low levels quite often. Remember that not everyone listening to your song has music blasting out. As well as giving your ears a break, it will heighten problems in the mix - Do the key elements have a good balance, or are some instruments more prominent than they should be? If something is too quiet or loud adjust its volume or use E.Q. to fix it. If the mix sounds good at low levels it's likely that it will when loud.

Note that on the CMC3 it is better to lower the volume level using the DIM switch and then turn the volume up, rather than only turning the volume down, as you maintain greater control over the volume as well as better left/right channel matching.

Increase the Volume of Quiet Passages.

Because the CMC3 circuitry is active it allows for the signal level to be increased, rather than only attenuated, making subtle problems within the mix, such as noise at low levels, or unwanted harmonics, more obvious and easier to iron out, especially during passages that would normally be quiet.

Here, There and Everywhere.....

Listen to your mix on as many systems as possible. The two monitor outputs allows for the addition of a non standard testing setup i.e. the system could be forced to emulate low-quality domestic reproduction systems as well as car speakers or a portable radio, by incorporating limited-bandwidth speakers to output B. In such conditions you may find that an instrument drops out of the mix, or another is too prominent, and adjustment to the mix need to be made. For best results calibrate the speakers to match the output level of the rest of the system.

Phase Reverse...

Make use of the phase reverse switch. If the sound doesn't become less focused when the polarity is flipped then there is something wrong somewhere. Not only will the switch help confirm that the monitors are wired up in the correct polarity, phase inversion on a particular instrument can at times improve the way the instrument interacts with the rest of the mix by removing the phase cancellation.

Cut It Out...

Using the left and right cut switches will highlight the stereo balance of each channel. In stereo the mix sounds ok, however, it may be that you want an instrument to be panned so far left that it doesn't occur at all in the right channel, by cutting the left and only hearing the right channel you will hear whether the instrument bleeds across, and panning adjustment can be made.

Monogising

Check your mix in mono - often! Just because a mix sounds good in stereo doesn't mean it will sound good when the left and right channels are combined. Why should you care if your mix sounds good in mono? Well, most live music venues and dance club sound systems are mono - running the PA or sound system in mono is common practice to ensure music sounds good everywhere in the room because it removes the 'sweet spot' and the complex phase issues of stereo. In many cases the low frequencies will be put through a crossover and summed to mono before being sent to the sub, such as in a home theatre system, for example. Monogising is also necessary when testing the audio for use on non-standard applications such as for broadcast or mobile phone.

In addition, monogising will highlight phase problems. In some cases, when you activate the Mono switch you may hear comb-filtering, which will colour the sound of your mix and cause peaks and dips in its frequency response. When a stereo mix is combined into mono any elements that are out of phase will drop in level or may even disappear completely. This could be because left and right outputs are wired out of phase but its more likely to be due to phase cancellation. What causes phase cancellation?

Many stereo widening effects and techniques, such as chorus;

Simultaneous direct box and mic recording - If you've ever recorded a guitar simultaneously through a direct box and a microphone, you may have noticed the time alignment problems this causes. This type of situation can often be fixed by careful mic placement, or realigning the waveform in a DAW;

Where more than one microphone is used to record a source - on a multi-miked drumkit two mics may pick up the same signal and cancel each other out. One handy tip is to adjust the panning of your drums whilst in mono - the phase cancellation of the drums will improve, and sound even better when reverted back to stereo.

Listening in mono also highlights problems with the stereo width and balance of the mix and is more apparent when you use a lot of stereo-widening or width-enhancing techniques and tools. Switching mono in and out fairly quickly may make it apparent that the centre of the mix is shifting to the left or right, something that may go unnoticed if only working in stereo.

True Mono

As a mono signal would normally originate from a single source it would be wrong to simply activate the mono switch - as both left and right speakers are still active. When you listen to a mono signal on two speakers, you hear a false or 'phantom' image which is derived midway between the speakers, but because both speakers are contributing to the sound, the level of the bass seems to be over-inflated. To truly hear a monogised signal via one speaker (the way everyone else will hear it)

DRAWMER

the mono switch should be active but also either Left Cut or Right Cut should also be activated (depending on preference/location) to derive the signal from a single location.

Listen to the 'Stereo difference' or side signal

A very useful facility of the CMC3 is the ability to listen to the 'stereo difference' or side signal, very quickly and easily. The side signal is the difference between the two channels, and describes those elements that contribute to the stereo width.

Hearing the stereo difference is so simple using the CMC3: with the stereo signal playing, activate the **Phase Reverse** switch, and then sum the left and right channels using the **Mono** switch (in other words Left-Right). It's that simple.

Being able to audition the 'side' signal is particularly useful for judging the quality and quantity of any ambience or reverberation in a stereo mix. It is also an invaluable facility if the stereo recording has timing differences between channels (such as caused by an azimuth error on a tape machine), or for aligning a pair of desk channels for use with X-Y stereo mic pairs. In both cases, listening for a deep cancellation null, as the two signals cancel each other out, is a very fast and accurate way of matching levels in each channel, which is the basis of accurate alignment.

Active vs. Passive Circuits

There is a great debate as to which is best - a passive or active monitor control circuit. The theory is that passive monitor controllers must be best, since they do not add transformers or other components to the signal path, along with the noise and distortion that they can bring, however they have severe disadvantages over active circuits. The most significant is that the output impedance of the connected source equipment and the input impedance of the power amp or active speaker will affect the workings of the passive controller - each needs buffering to remain reliable and consistent, otherwise level matching problems will be inevitable. Since even the best cables have capacitance, it is extremely important to keep cable lengths to an absolute minimum (i.e. less than a couple of meters) to avoid signal degradation especially in high frequency signals. Long cables will act like a simple low frequency filter.

Furthermore, it is incredibly difficult to get a mono signal from a passive circuit without affecting the sound so any kind of reliable mix checking becomes near impossible.

Active designs make it easier and more reliable to guarantee a high performance level as the signal attenuation and switching is actively buffered, as well as providing complete control over distortions, crosstalk, frequency response, and transient fidelity. Moreover, cable lengths of tens of meters should not be an issue. Furthermore, it makes it possible to introduce mix checking features that would otherwise be missing. The disadvantage with active monitor controllers is that the electronics have the potential to introduce noise and distortion. Designing a clean monitor control system is far from simple, however, using only the very best components and clever circuit design, with the Drawmer CMC3 we have overcome all of these problems and managed to combine the best of both - whilst retaining the transparency and responsiveness that a passive circuit would bring with the advantages of an active one.

CMC3 GENERAL INFORMATION**IF A FAULT DEVELOPS**

For warranty service please call Drawmer Electronics Ltd. or their nearest authorised service facility, giving full details of the difficulty. A list of all main dealers can be found on the Drawmer webpages. On receipt of this information, service or shipping instructions will be forwarded to you.

No equipment should be returned under the warranty without prior consent from Drawmer or their authorised representative.

For service claims under the warranty agreement a service Returns Authorisation (RA) number will be issued.

Write this RA number in large letters in a prominent position on the shipping box. Enclose your name, address, telephone number, copy of the original sales invoice and a detailed description of the problem.

Authorised returns should be prepaid and must be insured.

All Drawmer products are packaged in specially designed containers for protection. If the unit is to be returned, the original container must be used. If this container is not available, then the equipment should be packaged in substantial shock-proof material, capable of withstanding the handling for the transit.

CONTACTING DRAWMER

We will be pleased to answer all application questions to enhance your usage of Drawmer equipment.

Please address correspondence to:

DRAWMER Electronics LTD

Coleman Street
Parkgate
Rotherham
South Yorkshire
S62 6EL
United Kingdom

Telephone: **+44 (0) 1709 527574**

Fax: **+44 (0) 1709 526871**

Contact via E-mail: **tech@drawmer.com**

Further information on all Drawmer products, dealers, Authorised service departments and other contact information can be found on our website: **www.drawmer.com**

SPECIFICATION

Note: These specifications are provisional and may alter slightly upon product release.

INPUT

Maximum Input Level 27dBu

OUTPUT

Maximum Output Level
before clipping 27dBu

DYNAMIC RANGE

@ unity gain >115dB

CROSSTALK

L/R @ 1kHz >76dB

THD & NOISE

unity gain 0dBu input
0.015%

FREQUENCY RESPONSE

20Hz-20kHz +/- 0.2dB

PHASE RESPONSE

20Hz-20kHz +/- 2degrees

POWER REQUIREMENTS

External Power Supply

Input: 100-240V ~ 50-60Hz, 0.48A MAX.

Output: 15V  1A

Voltage automatically selected by PSU



EMC Standards EN55022:2006+A1:2007 /
EN6100-3-2 / EN6100-3-3

Use only the external PSU supplied by Drawmer or an accredited partner. Failure to do so could permanently damage the CMC2 and will also invalidate the warranty.

CASE SIZE

Depth 164mm
Width 276mm
Height 45mm

WEIGHT

1.7kg

DRAWMER

BLOCK DIAGRAM

EXTERNAL POWER SUPPLY

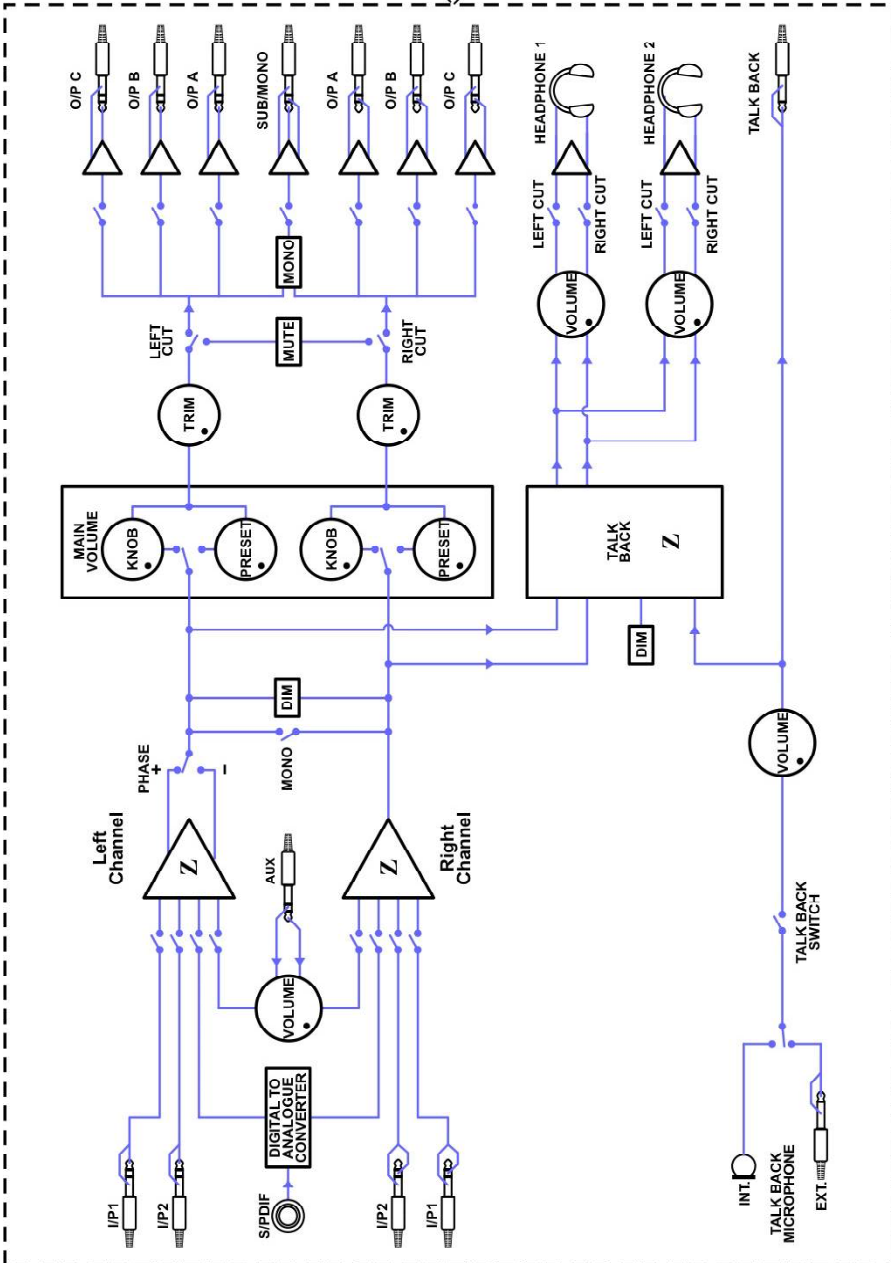

Ref:1v0B 14-08-18