



**DTX**  
drums

ELECTRONIC DRUM KIT

**DTX402K**  
**DTX432K**  
**DTX452K**

Owner's Manual

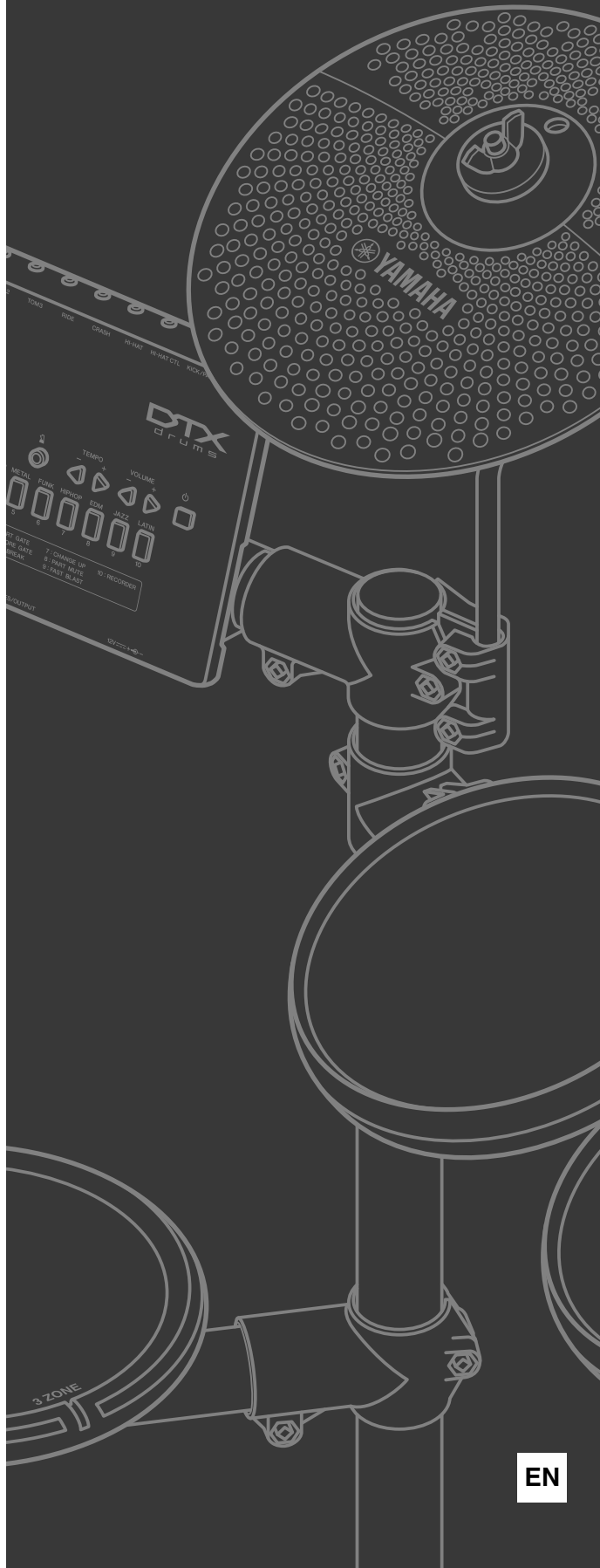

# For Instrument

## SPECIAL MESSAGE SECTION

This product utilizes batteries or an external power supply (adapter). DO NOT connect this product to any power supply or adapter other than one described in the manual, on the name plate, or specifically recommended by Yamaha.

**WARNING:** Do not place this product in a position where anyone could walk on, trip over, or roll anything over power or connecting cords of any kind. The use of an extension cord is not recommended! If you must use an extension cord, the minimum wire size for a 25' cord (or less) is 18 AWG. NOTE: The smaller the AWG number, the larger the current handling capacity. For longer extension cords, consult a local electrician.

This product should be used only with the components supplied or; a cart, rack, or stand that is recommended by Yamaha. If a cart, etc., is used, please observe all safety markings and instructions that accompany the accessory product.

### SPECIFICATIONS SUBJECT TO CHANGE:

The information contained in this manual is believed to be correct at the time of printing. However, Yamaha reserves the right to change or modify any of the specifications without notice or obligation to update existing units.

This product, either alone or in combination with an amplifier and headphones or speaker/s, may be capable of producing sound levels that could cause permanent hearing loss. DO NOT operate for long periods of time at a high volume level or at a level that is uncomfortable. If you experience any hearing loss or ringing in the ears, you should consult an audiologist.

**IMPORTANT:** The louder the sound, the shorter the time period before damage occurs.

Some Yamaha products may have benches and / or accessory mounting fixtures that are either supplied with the product or as optional accessories. Some of these items are designed to be dealer assembled or installed. Please make sure that benches are stable and any optional fixtures (where applicable) are well secured BEFORE using. Benches supplied by Yamaha are designed for seating only. No other uses are recommended.

### NOTICE:

Service charges incurred due to a lack of knowledge relating to how a function or effect works (when the unit is operating as designed) are not covered by the manufacturer's warranty, and are therefore the owners responsibility. Please study this manual carefully and consult your dealer before requesting service.

### ENVIRONMENTAL ISSUES:

Yamaha strives to produce products that are both user safe and environmentally friendly. We sincerely believe that our products and the production methods used to produce them, meet these goals. In keeping with both the letter and the spirit of the law, we want you to be aware of the following:

### Battery Notice:

This product MAY contain a small non-rechargeable battery which (if applicable) is soldered in place. The average life span of this type of battery is approximately five years. When replacement becomes necessary, contact a qualified service representative to perform the replacement.

This product may also use "household" type batteries. Some of these may be rechargeable. Make sure that the battery being charged is a rechargeable type and that the charger is intended for the battery being charged.

When installing batteries, never mix old batteries with new ones, and never mix different types of batteries. Batteries MUST be installed correctly. Mismatches or incorrect installation may result in overheating and battery case rupture.

### Warning:

Do not attempt to disassemble, or incinerate any battery. Keep all batteries away from children. Dispose of used batteries promptly and as regulated by the laws in your area. Note: Check with any retailer of household type batteries in your area for battery disposal information.

### Disposal Notice:

Should this product become damaged beyond repair, or for some reason its useful life is considered to be at an end, please observe all local, state, and federal regulations that relate to the disposal of products that contain lead, batteries, plastics, etc. If your dealer is unable to assist you, please contact Yamaha directly.

### NAME PLATE LOCATION:

The name plate is located on the bottom of the product. The model number, serial number, power requirements, etc., are located on this plate. You should record the model number, serial number, and the date of purchase in the spaces provided below and retain this manual as a permanent record of your purchase.

Model \_\_\_\_\_

Serial No. \_\_\_\_\_

Purchase Date \_\_\_\_\_

92-BP (bottom)

## PLEASE KEEP THIS MANUAL

### COMPLIANCE INFORMATION STATEMENT (DECLARATION OF CONFORMITY PROCEDURE)

Responsible Party : Yamaha Corporation of America  
Address : 6600 Orangethorpe Ave., Buena Park, Calif. 90620  
Telephone : 714-522-9011  
Type of Equipment : Electronic Drum Kit  
Model Name : DTX402K, DTX432K, DTX452K

This device complies with Part 15 of the FCC Rules.

Operation is subject to the following two conditions:

- 1) this device may not cause harmful interference, and
  - 2) this device must accept any interference received including interference that may cause undesired operation.
- See user manual instructions if interference to radio reception is suspected.

\* This applies only to products distributed by YAMAHA CORPORATION OF AMERICA.

(FCC DoC)

# For AC adaptor and Instrument

## FCC INFORMATION (U.S.A.)

### 1. IMPORTANT NOTICE: DO NOT MODIFY THIS UNIT!

This product, when installed as indicated in the instructions contained in this manual, meets FCC requirements. Modifications not expressly approved by Yamaha may void your authority, granted by the FCC, to use the product.

**2. IMPORTANT:** When connecting this product to accessories and/or another product use only high quality shielded cables. Cable/s supplied with this product MUST be used. Follow all installation instructions. Failure to follow instructions could void your FCC authorization to use this product in the USA.

**3. NOTE:** This product has been tested and found to comply with the requirements listed in FCC Regulations, Part 15 for Class "B" digital devices. Compliance with these requirements provides a reasonable level of assurance that your use of this product in a residential environment will not result in harmful interference with other electronic devices. This equipment generates/uses radio frequencies and, if not installed and used according to the instructions found in the users manual, may cause interference harmful to the operation of other electronic devices. Compliance with FCC regulations does not guarantee that interference will not

occur in all installations. If this product is found to be the source of interference, which can be determined by turning the unit "OFF" and "ON," please try to eliminate the problem by using one of the following measures:

Relocate either this product or the device that is being affected by the interference.

Utilize power outlets that are on different branch (circuit breaker or fuse) circuits or install AC line filter/s.

In the case of radio or TV interference, relocate/reorient the antenna. If the antenna lead-in is 300 ohm ribbon lead, change the lead-in to co-axial type cable.

If these corrective measures do not produce satisfactory results, please contact the local retailer authorized to distribute this type of product. If you can not locate the appropriate retailer, please contact Yamaha Corporation of America, Electronic Service Division, 6600 Orangethorpe Ave, Buena Park, CA90620

The above statements apply ONLY to those products distributed by Yamaha Corporation of America or its subsidiaries.

\* This applies only to products distributed by YAMAHA CORPORATION OF AMERICA.

(class B)

# For AC adaptor

This device complies with Part 15 of the FCC Rules. Operation is subject to the following two conditions:

(1) this device may not cause harmful interference, and (2) this device must accept any interference received, including interference that may cause undesired operation.

**CAN ICES-3 (B)/NMB-3(B)**

(can\_b\_02)

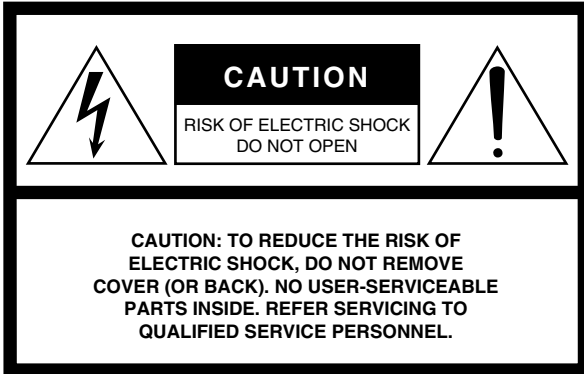

## Explanation of Graphical Symbols

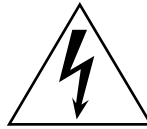

The lightning flash with arrowhead symbol within an equilateral triangle is intended to alert the user to the presence of uninsulated “dangerous voltage” within the product’s enclosure that may be of sufficient magnitude to constitute a risk of electric shock to persons.



The exclamation point within an equilateral triangle is intended to alert the user to the presence of important operating and maintenance (servicing) instructions in the literature accompanying the product.

## IMPORTANT SAFETY INSTRUCTIONS

- 1 Read these instructions.
- 2 Keep these instructions.
- 3 Heed all warnings.
- 4 Follow all instructions.
- 5 Do not use this apparatus near water.
- 6 Clean only with dry cloth.
- 7 Do not block any ventilation openings. Install in accordance with the manufacturer’s instructions.
- 8 Do not install near any heat sources such as radiators, heat registers, stoves, or other apparatus (including amplifiers) that produce heat.
- 9 Do not defeat the safety purpose of the polarized or grounding-type plug. A polarized plug has two blades with one wider than the other. A grounding type plug has two blades and a third grounding prong. The wide blade or the third prong are provided for your safety. If the provided plug does not fit into your outlet, consult an electrician for replacement of the obsolete outlet.
- 10 Protect the power cord from being walked on or pinched particularly at plugs, convenience receptacles, and the point where they exit from the apparatus.
- 11 Only use attachments/accessories specified by the manufacturer.
- 12 Use only with the cart, stand, tripod, bracket, or table specified by the manufacturer, or sold with the apparatus. When a cart is used, use caution when moving the cart/apparatus combination to avoid injury from tip-over.
- 13 Unplug this apparatus during lightning storms or when unused for long periods of time.
- 14 Refer all servicing to qualified service personnel. Servicing is required when the apparatus has been damaged in any way, such as power-supply cord or plug is damaged, liquid has been spilled or objects have fallen into the apparatus, the apparatus has been exposed to rain or moisture, does not operate normally, or has been dropped.



### WARNING

TO REDUCE THE RISK OF FIRE OR ELECTRIC SHOCK, DO NOT EXPOSE THIS APPARATUS TO RAIN OR MOISTURE.

(UL60065\_03)

### OBSERVERA!

Apparaten kopplas inte ur växelströmskällan (nätet) så länge som den är ansluten till vägguttaget, även om själva apparaten har stängts av.

**ADVARSSEL:** Netspændingen til dette apparat er IKKE afbrudt, så længe netledningen sidder i en stikkontakt, som er tændt — også selvom der er slukket på apparatets afbryder.

**VAROITUS:** Laitteen toisiopiiriin kytketty käyttökytin ei irroita koko laitetta verkosta.

# Contents

<b>PRECAUTIONS</b> .....	<b>4</b>
<b>Welcome</b> .....	<b>7</b>
<b>About the Manuals</b> .....	<b>7</b>
Printed Manual .....	7
Digital Manual (PDF).....	7

## Setup

<b>First Steps</b> .....	<b>8</b>
<b>Package Contents</b> .....	<b>9</b>
<b>Assembly Guide</b> .....	<b>12</b>
<b>Setting Up for Sound</b> .....	<b>21</b>
Connecting the Power.....	21
Connecting Headphones or Speakers .....	21
Connecting a Music Player .....	21
Turning On the Drum Module.....	22
Turning Off the Drum Module.....	22
Auto Power-Off .....	22
Restoring the Default Settings (Factory Reset).....	22
<b>Panel Controls &amp; Functions</b> .....	<b>23</b>
Control Panel .....	23
Bottom Panel.....	24
Top Panel .....	24

## Basic Techniques

<b>Playing Techniques</b> .....	<b>25</b>
Snare Pad .....	25
Hi-hat Cymbal .....	25
Crash Cymbal .....	25
<b>Performing with a Selected Music Category</b> .....	<b>26</b>
Selecting a Music Category .....	26
Adjusting Kit Sensitivity.....	26
Performing with a Song.....	27
Adjusting the Song Volume.....	27
Adjusting the Volume of Muted Drum Parts ....	28
Importing a MIDI song .....	28
<b>Using the Metronome</b> .....	<b>29</b>
Starting and Stopping the Metronome .....	29
Adjusting the Metronome Volume .....	29
Confirming Tempo.....	29
Adjusting the Tempo .....	30
Other Settings .....	30

<b>Practicing in Training Mode</b> .....	<b>31</b>
Before Training .....	31
Detailed Training settings .....	31
After Training .....	31
Switching to a different exercise .....	31
1. RHYTHM GATE .....	32
2. RHYTHM GATE.....	32
3. DYNAMIC GATE.....	33
4. SONG PART GATE .....	34
5. SONG SCORE GATE.....	35
6. MEASURE BREAK .....	36
7. CHANGE UP .....	37
8. PART MUTE.....	38
9. FAST BLAST .....	39
10. RECORDER.....	40

## Advanced Techniques

<b>Setting Parameters using Menu Mode</b> .....	<b>41</b>
Basic Menu Mode Procedure .....	41
<b>1</b> Metronome Settings.....	42
<b>2</b> Kit Settings.....	43
<b>3</b> MIDI Settings .....	45
<b>4</b> Hi-hat Settings .....	46
<b>5</b> Trigger Settings.....	48
<b>6</b> Training Settings .....	51
<b>7</b> Other Settings.....	53

## Integrating Separately

<b>Sold Accessories</b> .....	<b>57</b>
For DTX402K Owners .....	57
For DTX432K & DTX452K Owners .....	57
<b>Connecting to a Computer</b> .....	<b>58</b>
Installing the Yamaha Steinberg USB Driver ...	58
MIDI-related Reference .....	58

## Reference

<b>Troubleshooting</b> .....	<b>59</b>
<b>Data List</b> .....	<b>62</b>
<b>Specifications</b> .....	<b>64</b>
<b>Index</b> .....	<b>65</b>

# PRECAUTIONS

## PLEASE READ CAREFULLY BEFORE PROCEEDING

Please keep this manual in a safe and handy place for future reference.

### For AC adaptor



#### WARNING

- This AC adaptor is designed for use with only Yamaha electronic instruments. Do not use for any other purpose.
- Indoor use only. Do not use in any wet environments.



#### CAUTION

- When setting up, make sure that the AC outlet is easily accessible. If some trouble or malfunction occurs, immediately turn off the power switch of the instrument and disconnect the AC adaptor from the outlet. When the AC adaptor is connected to the AC outlet, keep in mind that electricity is flowing at the minimum level, even if the power switch is turned off. When you are not using the instrument for a long time, make sure to unplug the power cord from the wall AC outlet.

### For Instrument



#### WARNING

Always follow the basic precautions listed below to avoid the possibility of serious injury or even death from electrical shock, short-circuiting, damages, fire or other hazards. These precautions include, but are not limited to, the following:

##### Power supply/AC adaptor

- Do not place the power cord near heat sources such as heaters or radiators. Also, do not excessively bend or otherwise damage the cord, or place heavy objects on it.
- Only use the voltage specified as correct for the instrument. The required voltage is printed on the name plate of the instrument.
- Use the specified adaptor (page 64) only. Using the wrong adaptor can result in damage to the instrument or overheating.
- Check the electric plug periodically and remove any dirt or dust which may have accumulated on it.

##### Assembly

- Under no circumstances should any of the components of this product be taken apart or customized. Doing so could result in electric shock, fire, injury, or malfunction.

##### Water warning

- Do not expose the instrument to rain, use it near water or in damp or wet conditions, or place on it any containers (such as vases, bottles or glasses) containing liquids which might spill into any openings. If any liquid such as water seeps into the instrument, turn off the power immediately and unplug the power cord from the AC outlet. Then have the instrument inspected by qualified Yamaha service personnel.
- Never insert or remove an electric plug with wet hands.

##### Fire warning

- Do not put burning items, such as candles, on the unit. A burning item may fall over and cause a fire.

##### If you notice any abnormality

- When one of the following problems occur, immediately turn off the power switch and disconnect the electric plug from the outlet. Then have the device inspected by Yamaha service personnel.
  - The power cord or plug becomes frayed or damaged.
  - It emits unusual smells or smoke.
  - Some object has been dropped into the instrument.
  - There is a sudden loss of sound during use of the instrument.

## **CAUTION**

**Always follow the basic precautions listed below to avoid the possibility of physical injury to you or others, or damage to the instrument or other property. These precautions include, but are not limited to, the following:**

### **Power supply/AC adaptor**

- Do not connect the instrument to an electrical outlet using a multiple-connector. Doing so can result in lower sound quality, or possibly cause overheating in the outlet.
- When removing the electric plug from the instrument or an outlet, always hold the plug itself and not the cord. Pulling by the cord can damage it.
- Remove the electric plug from the outlet when the instrument is not to be used for extended periods of time, or during electrical storms.

### **Assembly**

- Read carefully the attached documentation explaining the assembly process. Failure to assemble the instrument in the proper sequence might result in damage to the instrument or even injury.
- Do not place hands or feet under a foot switch or foot pedal. Doing so could result in injury.
- Do not use the electronic drum kit's rack to hold acoustic drums. Doing so could cause clamps to break and the drums to fall off, which in turn could lead to injury.
- Mind your fingers when adjusting clamps. Fingers can easily be caught and crushed if care is not taken during this operation.
- Be careful with the tips of supports, arms, screws, and the like. Fingers can easily be injured by sharp tips if these components are not handled carefully.
- Do not sit or stand on the rack. Doing so could cause it to fall over or break, possibly causing injury.
- Be careful with the holders for cymbal and tom pads as they have sharp tips. In order to avoid injury, therefore, you should take special care whenever handling these components.
- Be careful with the anti-slip stoppers on kick pads and foot pedals as they have sharp tips. In order to avoid injury, therefore, you should take special care whenever handling these components.
- Securely tighten fixing nuts and other fasteners. In addition, be sure to immediately tighten any nuts that have come loose. If this precaution is not observed, pads may fall off or the rack may collapse or fall over, possibly causing injury.
- Take care when setting up cables. If anyone were to trip on a cable, the instrument could topple over and cause injury.

### **Location**

- Do not place the instrument in an unstable position where it might accidentally fall over.
- The flooring material (wooden floor, etc.) may be damaged if the instrument is placed directly on the floor. We recommend that you place it on carpet or the like.
- Before moving the instrument, remove all connected cables, to prevent damage to the cables or injury to anyone who might trip over them.
- When setting up the product, make sure that the AC outlet you are using is easily accessible. If some trouble or malfunction occurs, immediately turn off the power switch and disconnect the plug from the outlet. Even when the power switch is turned off, electricity is still flowing to the product at the minimum level. When you are not using the product for a long time, make sure to unplug the power cord from the wall AC outlet.
- Use only the stand/rack specified for the instrument. When attaching it, use the provided screws only. Failure to do so could cause damage to the internal components or result in the instrument falling over.

### **Connections**

- Before connecting the instrument to other electronic components, turn off the power for all components. Before turning the power on or off for all components, set all volume levels to minimum.
- Be sure to set the volumes of all components at their minimum levels and gradually raise the volume controls while playing the instrument to set the desired listening level.

### **Handling caution**

- Avoid contact with grease. Grease is applied to pedals as a lubricant, which may attach to your clothes when carrying or setting up them.
- Do not insert a finger or hand in any gaps on the instrument.
- Never insert or drop paper, metallic, or other objects into the gaps on the panel. This could cause physical injury to you or others, damage to the instrument or other property, or operational failure.
- Do not rest your weight on, or place heavy objects on the instrument, and do not use excessive force on the buttons, switches or connectors.
- Do not use the instrument/device or headphones for a long period of time at a high or uncomfortable volume level, since this can cause permanent hearing loss. If you experience any hearing loss or ringing in the ears, consult a physician.

Yamaha cannot be held responsible for damage caused by improper use or modifications to the instrument, or data that is lost or destroyed.

Always turn the power off when the instrument is not in use.

Even when the [  ] (Standby/On) switch is in standby status (all lamps are off), electricity is still flowing to the instrument at the minimum level.

When you are not using the instrument for a long time, make sure you unplug the power cord from the wall AC outlet.

## NOTICE

To avoid the possibility of malfunction/damage to the product, damage to data, or damage to other property, follow the notices below.

### ■ Handling and Maintenance

- Do not use the instrument in the vicinity of a TV, radio, stereo equipment, mobile phone, or other electric devices. Otherwise, the instrument, TV, or radio may generate noise. When you use the instrument along with an application on your smart device, we recommend that you set "Airplane Mode" to "ON" on that device in order to avoid noise caused by communication.
- Do not expose the instrument to excessive dust or vibrations, or extreme cold or heat (such as in direct sunlight, near a heater, or in a car during the day) to prevent the possibility of panel disfiguration, damage to the internal components or unstable operation.
- Do not place vinyl, plastic or rubber objects on the instrument, since this might discolor the panel.

### ■ Maintenance

- When cleaning the drum module, use a soft and dry/slightly damp cloth. Do not use paint thinners, solvents, alcohol, cleaning fluids, or chemical-impregnated wiping cloths.
- When cleaning the pads, avoid cleaning products that contain organic solvents, paint thinner, and alcohol as they can cause discoloration and/or warping. Instead, we recommend that you remove dust using a soft dry cloth or wipe clean with a moist, tightly-wrung-out cloth. If a pad is very dirty, wipe the dirt away using a cloth moistened with a neutral detergent solution and tightly wrung out. Following this, wipe away the detergent solution using a cloth soaked in water and tightly wrung out.

## Information

### ■ About copyrights

- Copying of the commercially available musical data including but not limited to MIDI data and/or audio data is strictly prohibited except for your personal use.
- This product incorporates and bundles contents in which Yamaha owns copyrights or with respect to which Yamaha has license to use others' copyrights. Due to copyright laws and other relevant laws, you are NOT allowed to distribute media in which these contents are saved or recorded and remain virtually the same or very similar to those in the product.
  - \* The contents described above include a computer program, Accompaniment Style data, MIDI data, WAVE data, voice recording data, a score, score data, etc.
  - \* You are allowed to distribute medium in which your performance or music production using these contents is recorded, and the permission of Yamaha Corporation is not required in such cases.

### ■ About this manual

- The illustrations and LCD screens as shown in this manual are for instructional purposes only, and may appear somewhat different from those on your instrument.
- Apple, iTunes, Mac, Macintosh, iPhone, iPad, iPod touch and Lightning are trademarks of Apple Inc., registered in the U.S. and other countries.
- IOS is a trademark or registered trademark of Cisco in the U.S. and other countries and is used under license.
- The company names and product names in this manual are the trademarks or registered trademarks of their respective companies.

The model number, serial number, power requirements, etc., may be found on or near the name plate, which is at the bottom of the unit. You should note this serial number in the space provided below and retain this manual as a permanent record of your purchase to aid identification in the event of theft.

**Model No.**

---

**Serial No.**

---

(bottom\_en\_01)



## Welcome

Thank you for purchasing this Yamaha product.

To get the most out of your DTX402 series Electronic Drum Kit, be sure to read this Owner's Manual carefully. And after reading through this manual, be sure to store it in a safe place so that you can refer back to it again as needed.

## About the Manuals

The following manuals are provided for using the DTX402K, DTX432K, and DTX452K. These manuals are intended for users of the DTX402K, DTX432K, and DTX452K.

---

### Printed Manual

---



#### Owner's Manual (this book)

##### Setup

Describes how to assemble your electronic drum kit and get it set up for playing.

##### Basic Techniques

Describes the basic techniques used when operating and playing the electronic drum kit.

##### Advanced Techniques

Describes the setting of parameters and other more advanced modes of use.

##### Reference

Describes troubleshooting techniques and contains other reference materials.

---

### Digital Manual (PDF)

---



#### MIDI Reference Manual

This provides MIDI-related reference information.



#### Drum Scores

This provides drum scores for preset songs of the drum module.



#### iPhone/iPad Connection Manual

Describes how to connect smart devices such as an iPhone and iPad.

The digital format manuals listed above can be obtained from the Yamaha Downloads web page. To do so, go to the web page using the following URL, enter your drum kit name in the "Model Name" field, and then click "Search."

Yamaha Downloads: <https://download.yamaha.com/>

After accessing the Support website (and clicking on "Manual Library"), enter the appropriate model name.

# First Steps

1

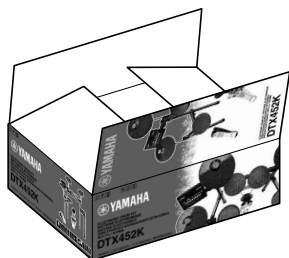

Open the box and confirm that all parts are present and correct.

2

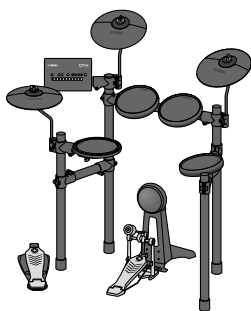

Assemble the parts.

- The assembly process is described in detail on pages 9 through 20.

3

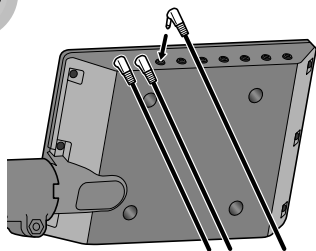

Make the necessary connections.

- Connect the pads to the drum module using the cables provided.  
→ See page 20.
- Connect the AC adaptor to the drum module and turn on the module.  
→ See page 21.

4

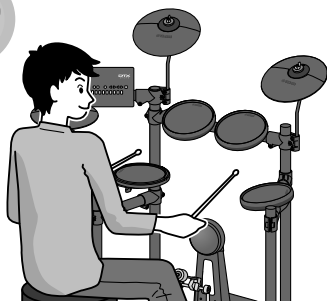

Play your electronic drum kit.

- Basic techniques used when operating and playing the electronic drum kit are described in the Basic Techniques section (pages 25 to 40).
- More complex methods are described in the Advanced Techniques section (pages 41 to 56).

# Package Contents

After opening up the package containing your electronic drum kit, please verify that all of the following parts are present.

## DTX402K

Rack (Large)

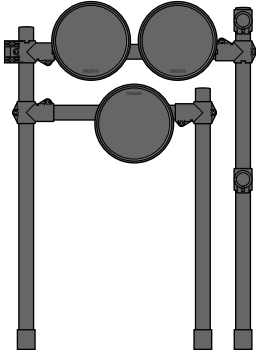

Rack (Small)

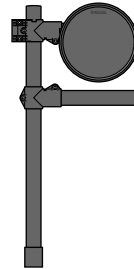

Hi-hat holder

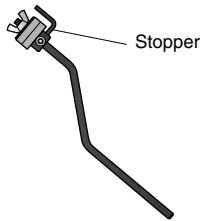

Stopper

Cymbal holders (x2)

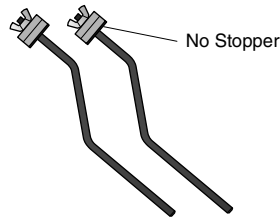

No Stopper

Cymbal/hi-hat pads (x2)

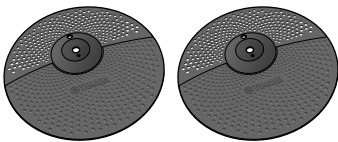

Crash cymbal pad

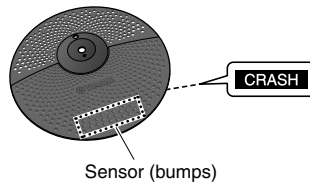

Sensor (bumps)

Drum module



HH40 Hi-hat controller



HI-HAT CTL

KU100 Kick unit



KICK

Nine-channel snake cable

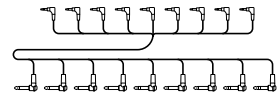

Drum key



Cable bands (x2)



AC adaptor

\* May not be included depending on your particular area. Please check you're your Yamaha dealer.

Owner's Manual (this booklet)

# DTX432K

Rack (Large)

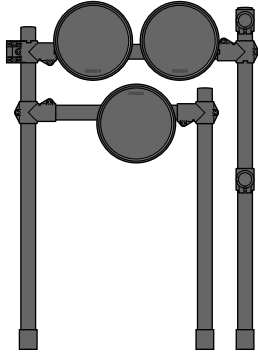

Rack (Small)

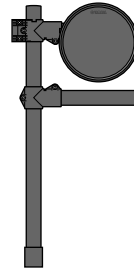

Hi-hat holder

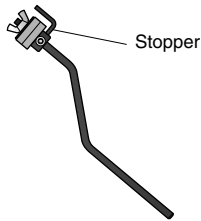

Stopper

Cymbal holders (x2)

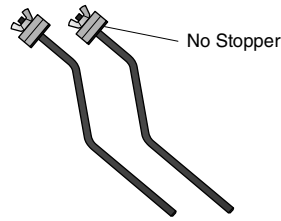

No Stopper

Cymbal/hi-hat pads (x2)

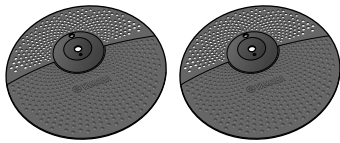

Crash cymbal pad

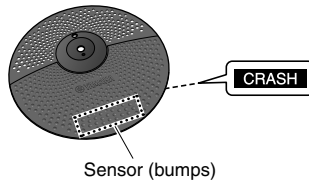

Sensor (bumps)

Drum module



HH65  
Hi-hat controller

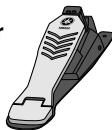

KP65  
Kick pad



FP6110A  
Foot pedal

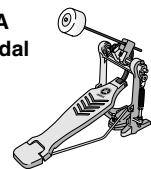

Nine-channel snake cable

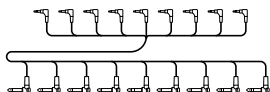

Drum key

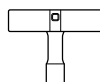

Cable bands (x2)



AC adaptor

\* May not be included depending on your particular area. Please check you're your Yamaha dealer.

Owner's Manual (this booklet)

# DTX452K

Rack (Large)

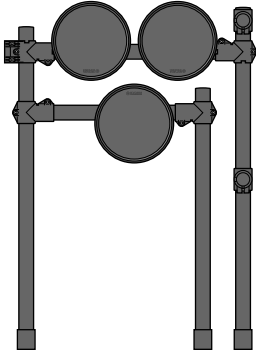

Rack (Small)

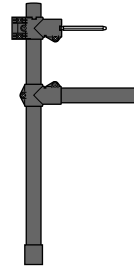

TP70S Snare pad



Hi-hat holder

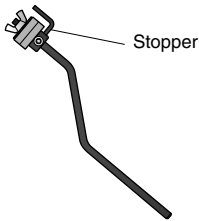

Stopper

Cymbal holders (x2)

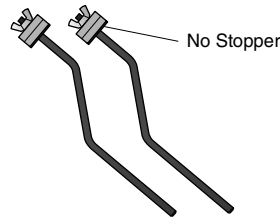

No Stopper

S wing bolt



Cymbal/hi-hat pads (x2)

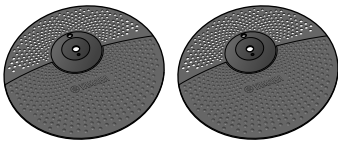

Crash cymbal pad

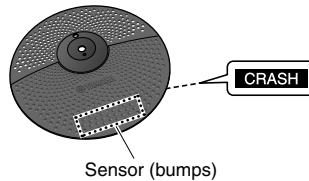

Sensor (bumps)

Drum module



HH65  
Hi-hat controller

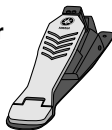

KP65  
Kick pad



FP6110A  
Foot pedal

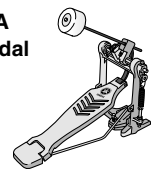

Nine-channel snake cable

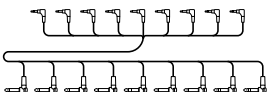

Drum key

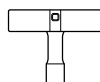

Cable bands (x2)



AC adaptor

\* May not be included depending on your particular area. Please check you're your Yamaha dealer.

Owner's Manual (this booklet)

# Assembly Guide

Fully assembled drum kit (DTX452K shown)

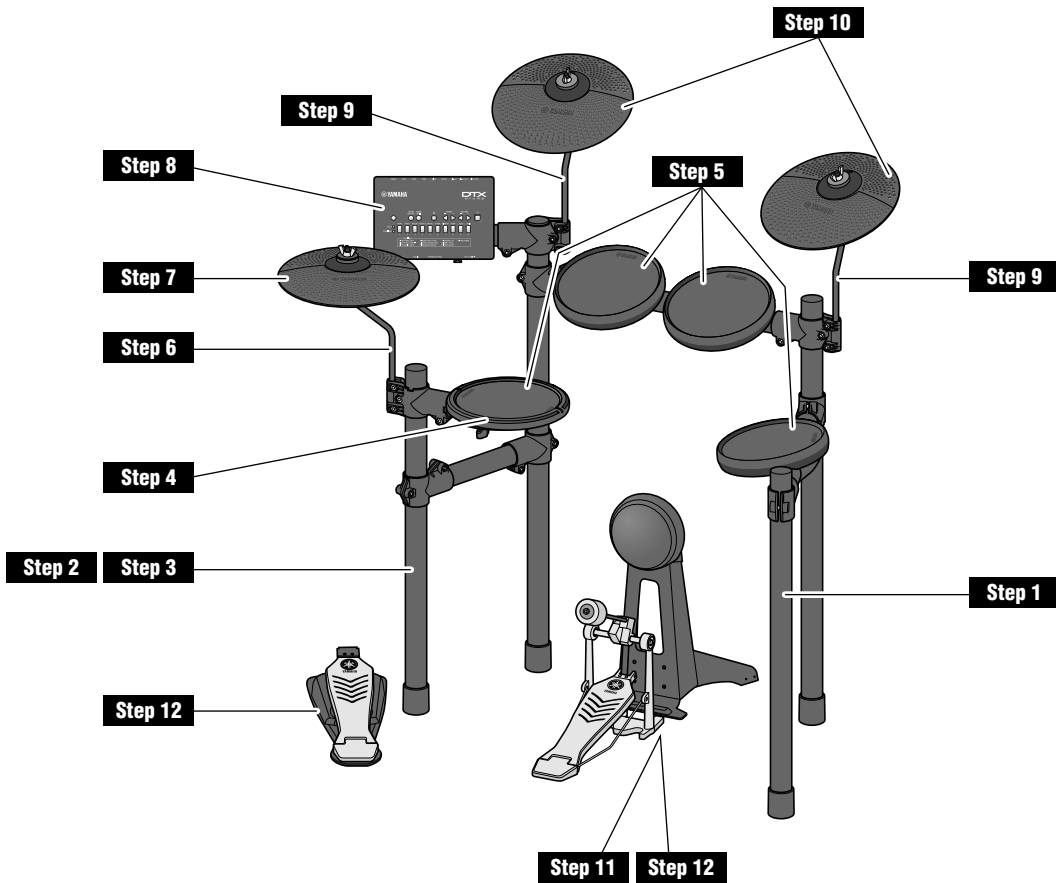

## ⚠ CAUTION

- Choose a flat, hard surface on which to assemble your electronic drum kit.
- Take care to avoid mixing up parts or assembling them in the wrong direction. In addition, the assembly steps should be completed one at a time in the order described.
- The assistance of at least one other person will be required when assembling the electronic drum kit.
- Once a piece has been assembled, be sure to tighten the corresponding key bolts.
- To disassemble your electronic drum kit, carry out the assembly sequence in reverse.

### Step 1 Standing up the Large rack

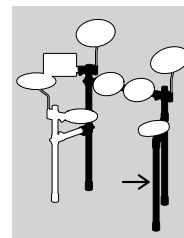
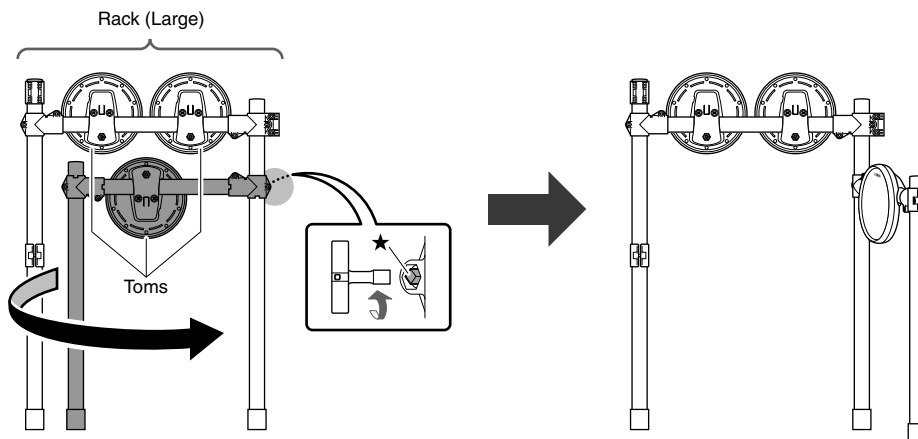

1. Stand up the Large rack with the rear of the tom pads facing towards you as shown in the figure.
2. Loosen the ★ key bolt using the drum key.
3. Pull the shorter leg towards you.

### Step 2 Standing up the Small rack

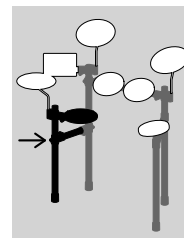
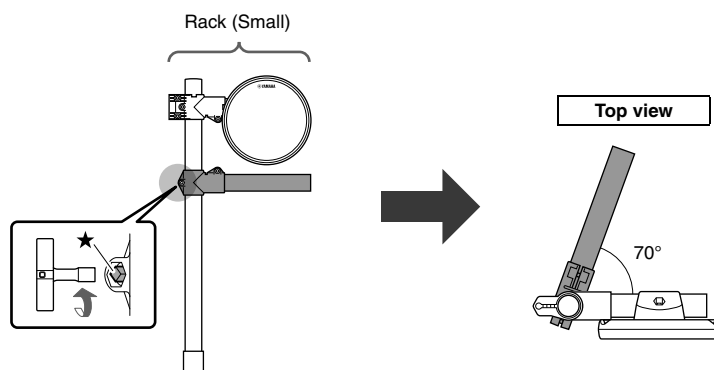

1. Stand up the Small rack as shown in the figure and support it by hand.

**For the DTX452K, the snare pad will be attached to the Small rack in the following step.**

2. Loosen the ★ key bolt.
3. Open the lower pipe approximately 70° as shown in the Top view.

### Step 3 Assembling the rack

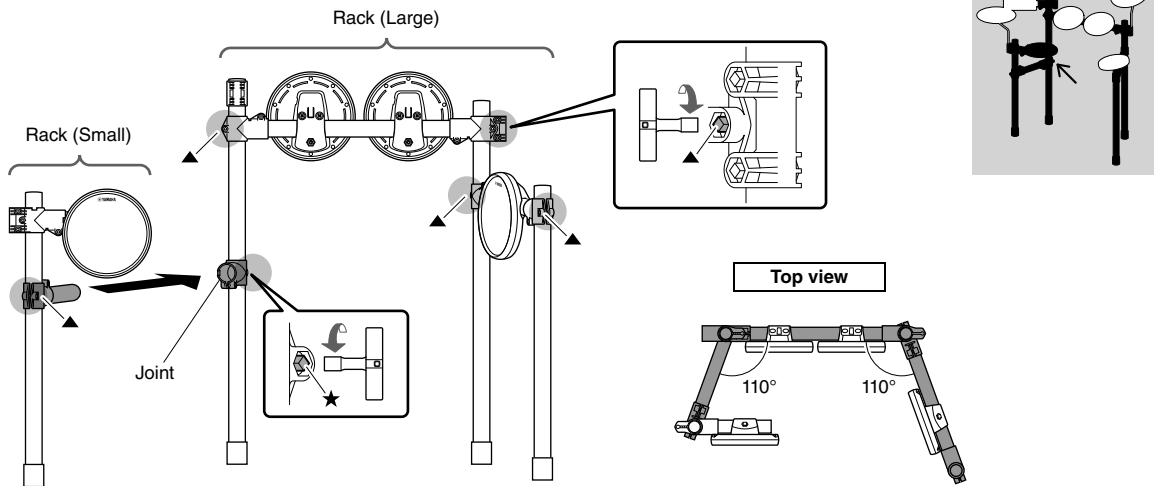

1. Loosen the ★ key bolt on the rack (Large) and turn the joint around before sliding the Small rack (in the next step).
2. Slide the Small rack fully back into the joint in **Step 1**.

**For the DTX452K, the snare pad will be attached to the Small rack in the following step.**

3. Open the left and right legs as shown in the Top view.

#### ⚠ CAUTION

The rack may topple over and cause injury if the left and right legs are opened too wide.

4. Tighten the one ★ and five ▲ key bolts to secure the entire rack.

#### NOTE

The pads will be rotated into place in a later step.

### Step 4 For DTX452K Attaching the snare pad

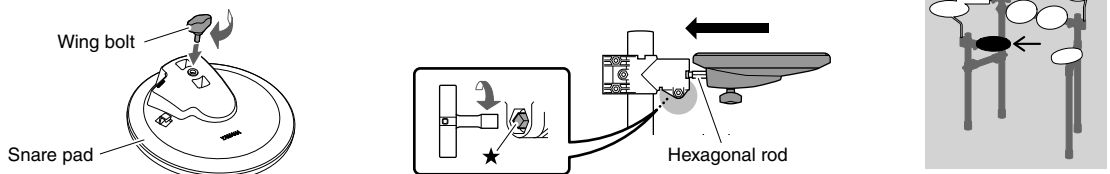

1. Take the snare pad and the S wing bolt and lightly tighten the S wing bolt. (Five or six turns is sufficient.)
2. Place the snare pad on the hexagonal rod and slide it fully back. Then tighten the S wing bolt to secure the snare pad in place.
3. Loosen the ★ key bolt and adjust the angle of the snare pad. When finished, retighten the ★ key bolt to secure the snare pad in place.



## Step 5 Rotating the pads into place

### For DTX402K and DTX432K

Step 5 applies to each of the four pads.

### For DTX452K

Step 5 applies to each of the three tom pads. For adjusting the snare pad, see **Step 4**.

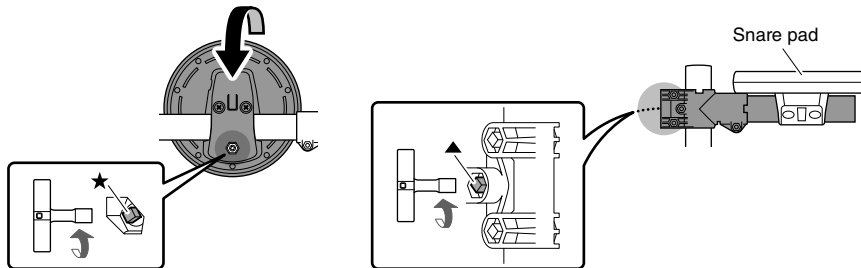
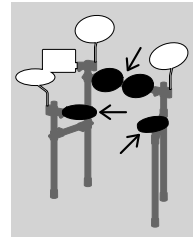

1. Loosen the ★ key bolt on each of the pads.
2. Rotate the pads to positions where they will be easy to play. (If necessary, refer to the picture of the properly assembled kit on page 12.)

**NOTE**

For the snare pad, you can also adjust the angle of the joint which supports the snare pad by loosening the ▲ key bolt.

3. Tighten each of the key bolts to secure the pads in place.

## Step 6 Attaching the hi-hat holder

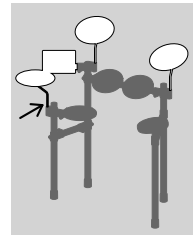
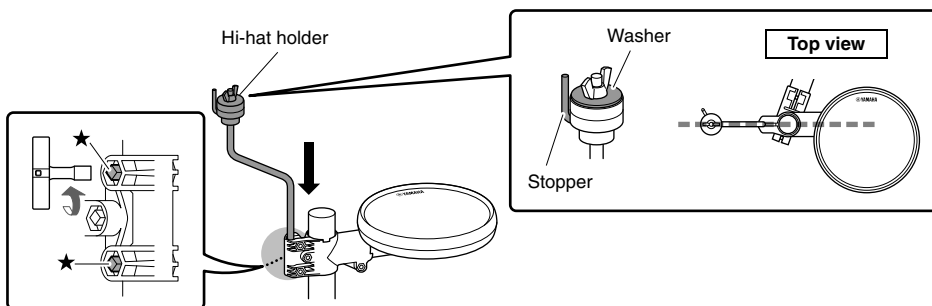

1. Loosen the two ★ key bolts in the back of the snare part.
2. Insert the hi-hat holder into the back of the snare part as shown in the figure.

**The hi-hat holder and the other two cymbal holders seem similar, but are actually different. Only the hi-hat holder has a washer and stopper.**

- When correctly inserted, the tip of the hi-hat holder will protrude slightly from the bottom of the snare part.
- When correctly oriented, the hi-hat holder will be horizontal to the snare part as shown in the Top view.

3. Tighten the two ★ key bolts to secure the hi-hat holder.

## Step 7 Attaching the hi-hat pad

### ● Adjusting the position of the hi-hat stopper

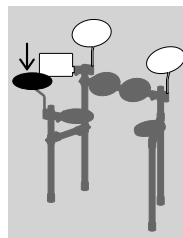
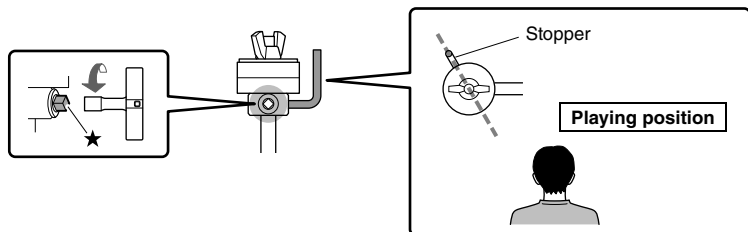

1. Loosen the ★ key bolt on the stopper, which is located at the top of the hi-hat holder.
2. Adjust the position of the stopper until it is straight in the back (as shown in the illustration) from your playing position.
3. Tighten the ★ key bolt to secure the stopper.

### ● Assembling the hi-hat pad

1. Remove the wing nut, the washer, and the upper felt pad from the hi-hat holder. (Do not remove the lower felt pad.)
2. Place the hi-hat pad, which does **NOT** have a sticker labeled “CRASH,” on the hi-hat holder with the stopper also passing through the hole provided.
3. Replace the felt pad removed in **Step 1** above the hi-hat pad.
4. Replace the washer removed in **Step 1** above the felt pad.
5. Tighten the wing nut to secure the hi-hat pad in place.

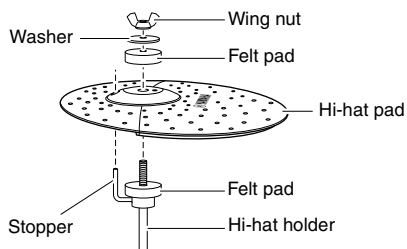

## Step 8 Attaching the drum module

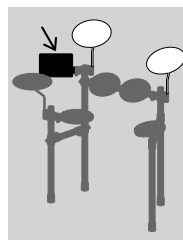
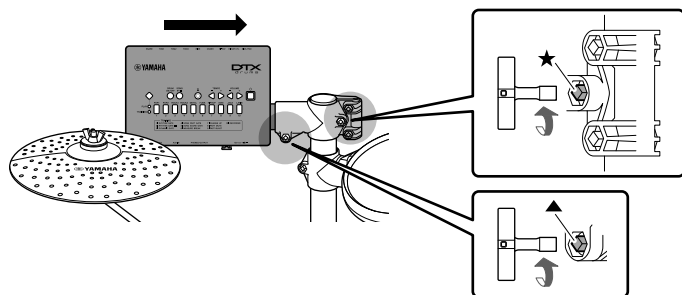

1. Loosen the ★ key bolt on the back left of the rack and turn the joint around before sliding the sliding the drum module (in the next step).
2. Loosen the ▲ key bolt and slide the drum module fully back into the joint in **Step 1**.
3. Tighten the ★ and ▲ key bolts to secure the drum module in place.

### Step 9 Attaching the cymbal holders

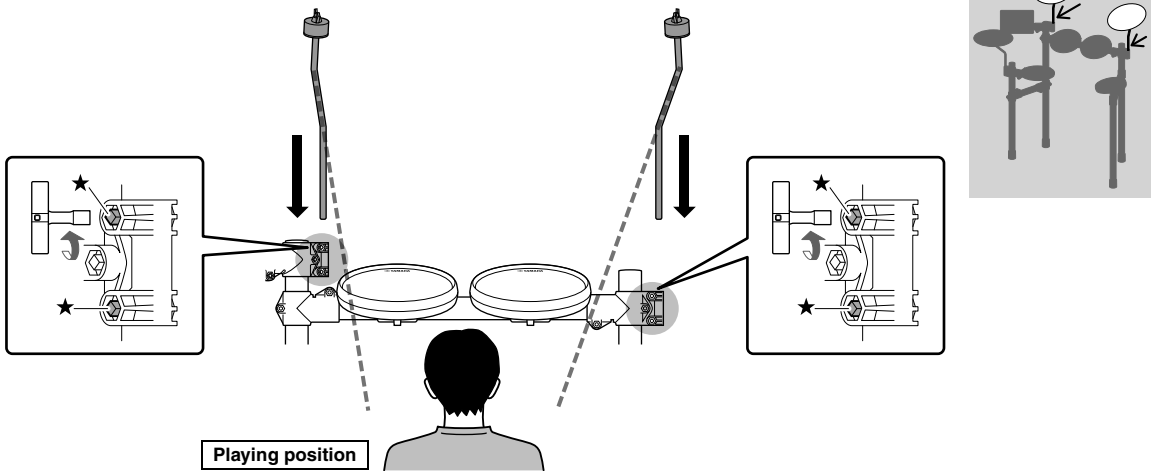

1. Loosen the four ★ key bolts at the ends of the tom 1/2 part.
2. Insert the cymbal holders into the ends of the top 1/2 part. Then adjust the angles of the cymbal holders until they are oriented as shown in the figure.

**NOTE**

The two cymbal holders are identical.

- When correctly inserted, the tips of the cymbal holders will protrude slightly from the bottom of the tom part.
- When correctly oriented, the cymbal holders will bend in the back from your playing position.

3. Tighten the four ★ key bolts to secure the cymbal holders in place.

### Step 10 Assembling the cymbal pads

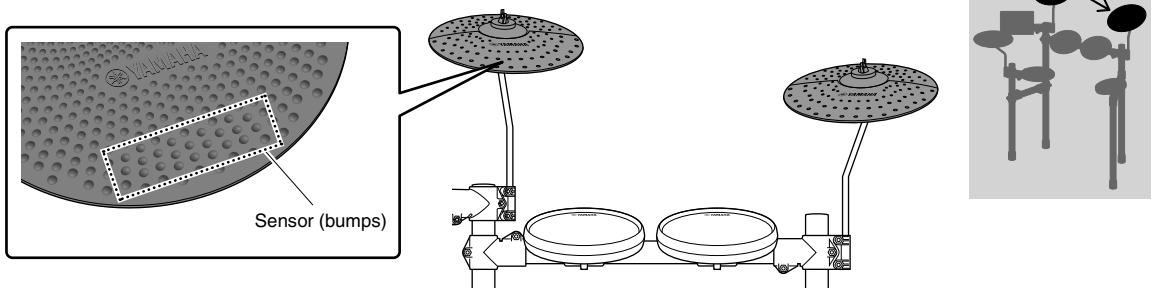

The crash cymbal, which has the sticker labeled “CRASH” on the rear side and has some bumps on the front side, is for the **left**.

The normal cymbal, which is identical with the hi-hat cymbal, is for the **right**.

1. Remove the wing nut and the upper felt pad from the cymbal holder. (Do not remove the lower felt pad.)
2. Place the cymbal pad on the cymbal holder, with the holder passing through the central hole.
3. Replace the felt pad removed in **Step 1** above the cymbal pad.
4. Tighten the wing nut to secure the cymbal pad in place.

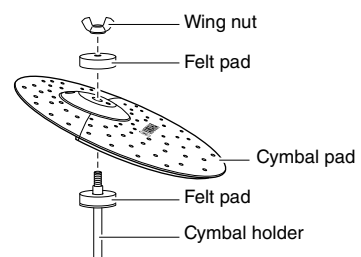

## Step 11 For DTX432K and DTX452K Assembling the kick pad



1. Remove the four wing bolts, spring washers, and flat washers from the kick pad, and arrange each set nearby in the disassembled condition.
2. Assemble the base to the kick pad as shown below, and then from the base side, assemble the wing bolts, spring washers, and flat washers removed in **Step 1** in order to secure it in place.

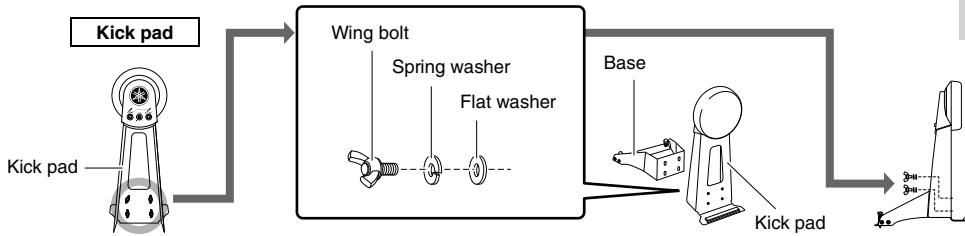

3. Insert the connecting rods into the holes in the holder of the foot pedal as shown below.
4. Slide the beater into the hole until the tip protrudes approximately 15 mm from the rear, and then tighten the beater bolt using the drum key.

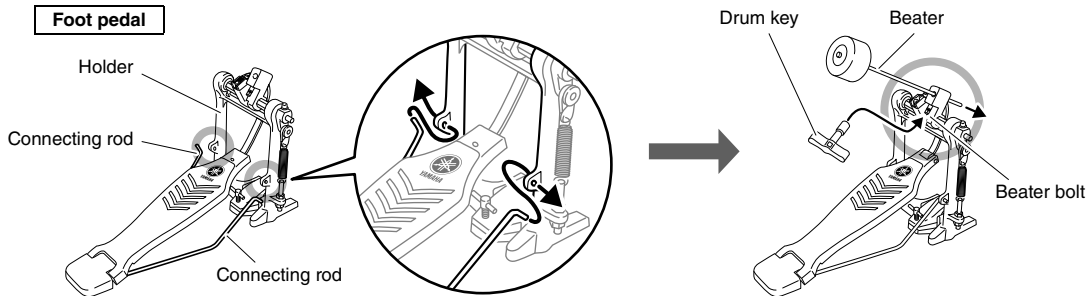

5. Turn the foot pedal's T-bolt counter-clockwise to loosen it.

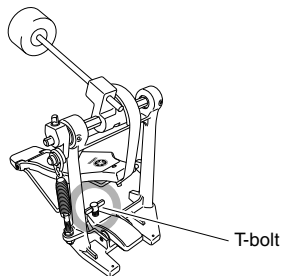

6. Fit the raised section at the front of the kick pad holder into the foot-pedal's assembly bracket.
7. Turn the foot pedal's T-bolt clockwise to secure the parts together.
8. Operate the pedal and confirm whether the beater head strikes the kick pad near the center. If not, adjust the length of the beater or move it left or right as required.

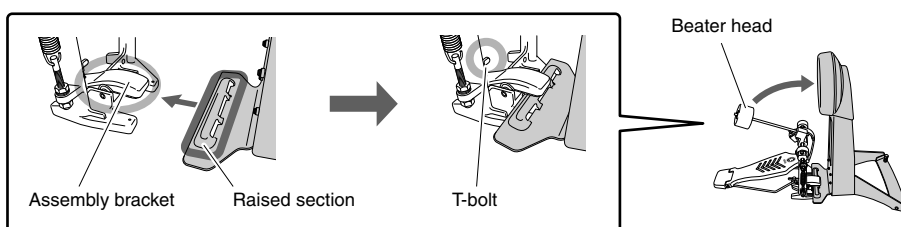

## Step 12 Positioning the hi-hat controller and kick drum

Arrange the hi-hat controller and the kick drum parts or kick unit as shown in the figure.

### IMPORTANT

The hi-hat controller and the kick unit from the DTX402K are almost identical in appearance. They can be told apart by the sticker on the base section.

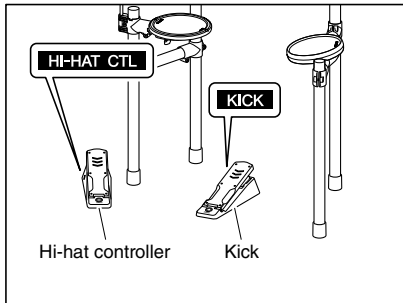

DTX402K

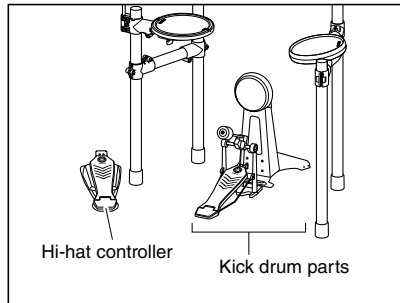

DTX432K, DTX452K

## Step 13 Fine-tuning the positions of the pads and the drum module

Sit on your stool (sold separately) and adjust the positions of the pads and the drum module to your liking.

### CAUTION

- Be sure to always retighten any key bolt after you have finished adjusting the corresponding part.
- Before moving on to the next step, ensure that all key bolts have been tightened.

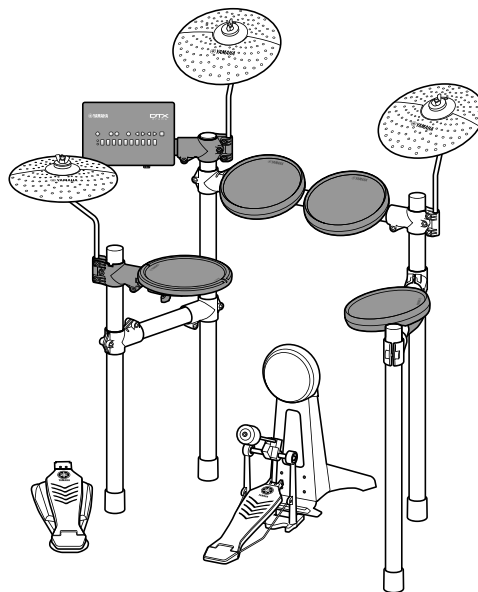

### Step 14 Connecting the pads to the drum module

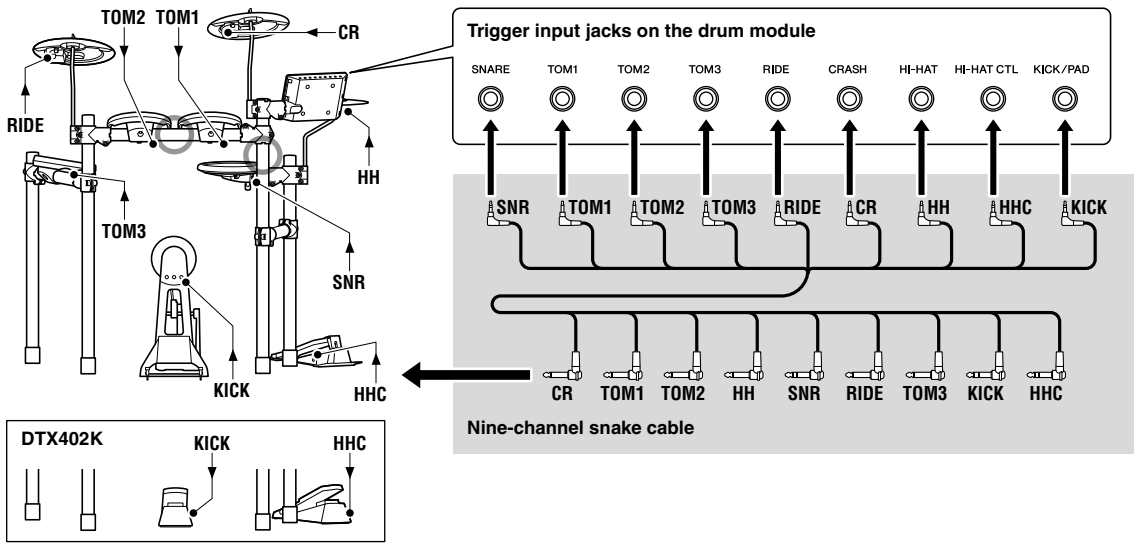

1. Insert the mini plugs\* at one end of the nine-channel snake cable into the correct trigger input jacks (SNARE to KICK/PAD) on the drum module. (\*: The smaller set of plugs.)

**NOTE**

The sticker on each of the snake cable's plugs indicates the name of the corresponding pad.

2. Insert the nine-channel snake cable's standard plugs\* into the jacks in the corresponding pads. (\*: The larger set of plugs.)

**NOTE**

For the kick pad KP65 in the DTX432K and DTX452K, use the OUT▶DTX jack. No sound will be played when the PAD▶IN jack is used.

3. Wrap the cables for the snare pads, the tom pads, and the cymbal/hi-hat pads around the cable clips to prevent them from being pulled out.

**NOTICE**

Excessive bending can damage the cables. Ensure, therefore, that they are not bent at an extreme angle when wrapped around the clips.

4. Using the cable bands, secure the cables to the kit rack at the ○ positions in the figure above.

*Congratulations—You have finished assembling your electronic drum kit!*

### Here is a left-handed setup.

**Fully assembled drum kit (DTX452K shown)**

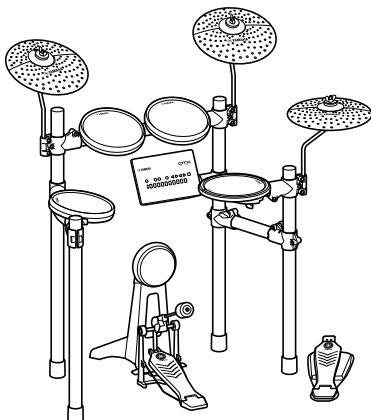

Please assemble the drum kit referring to the image.

**NOTE**

Please ensure that the two joints in the figure below are used in different ways from how they are used in the right-handed setup.

Right-handed ..... Left-handed .....

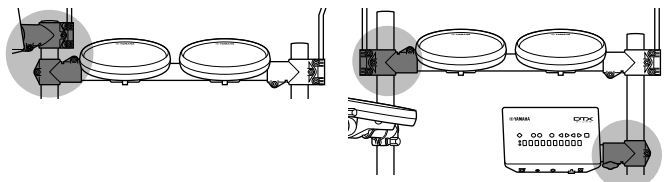

# Setting Up for Sound

## Connecting the Power

1. Ensure that your drum module is turned off (i.e., none of the buttons are lit).
2. Insert the AC adaptor's DC plug into the [ 12V  $\equiv$  +  $\ominus$  - ] connector on the bottom panel of the module.
3. Hook the AC adaptor cord around the cord clip to prevent it from being accidentally pulled out.

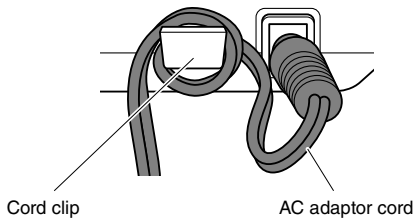

### ⚠ CAUTION

Excessive bending can damage the AC adaptor cord and create a fire hazard. Ensure, therefore, that the power cord is not bent at an extreme angle when wrapped around the clip.

4. Plug the adaptor's AC power cord into an AC wall socket or another electrical outlet.

### ⚠ WARNING

- Use the specified AC adaptor (page 64) only. Using the wrong AC adaptor can result in damage to the instrument or overheating.
- When using the AC adaptor with a removable plug, make sure to keep the plug attached to the AC adaptor. Using the plug alone can cause electric shock or fire.
- Never touch the metallic section when attaching the plug. To avoid electric shock, short circuit or damage, also be careful that there is no dust between the AC adaptor and plug.

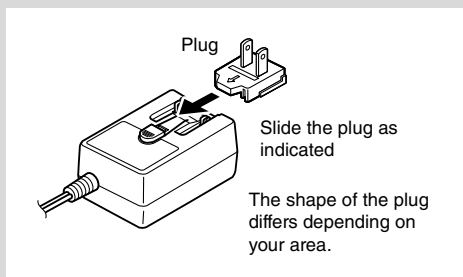

## Connecting Headphones or Speakers

Your drum module does not have built-in speakers. In order to hear it, therefore, you will need to connect headphones or monitor speakers via the [PHONES/OUTPUT] standard stereo-audio jack. You can adjust the output volume using the [VOLUME] buttons on the control panel.

### NOTE

The [PHONES/OUTPUT] jack is a stereo connector. You can connect a 1/4" mono-audio jack to it, but in such a case, please be sure to set the output to mono using the Stereo/Mono parameter from Menu Mode (page 55).

### ⚠ CAUTION

To prevent hearing loss, avoid using headphones at a high volume for extended periods of time.

## Connecting a Music Player

You can connect a portable music player or another similar source of audio to your drum module via the [AUX IN] (auxiliary input) stereo mini-jack. This makes it possible to play along with your favorite tunes.

### NOTICE

- Whenever connecting other devices, ensure that the cables you use have plugs that match the input or output connectors on those devices.
- Before making connections, furthermore, you should also turn the volume on the other devices fully down.
- When all connections have been made, use each device's volume controller to balance its output with that of the drum module.

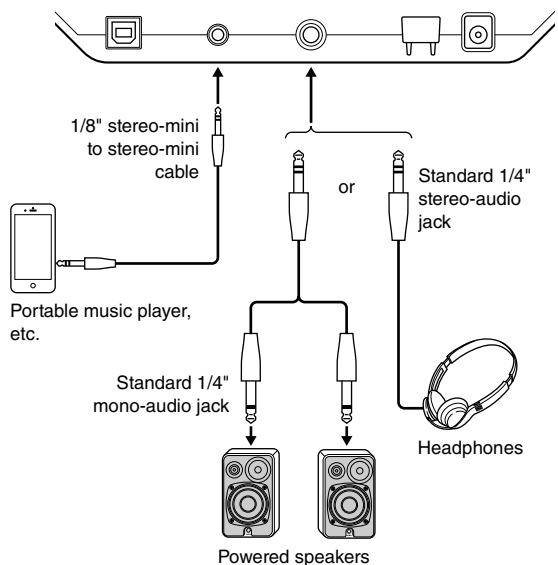

## Turning On the Drum Module

1. If you have connected your drum module to other audio devices such as powered speakers, ensure that the volume on all other devices is turned down fully.
2. Press the [  ] (Standby/On) button.  
The drum module will turn on and its buttons will light up.

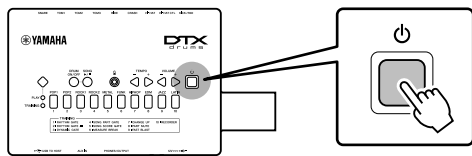

### NOTE

Connect the hi-hat controller before turning on the drum module. Please do not turn the drum module on with the hi-hat controller depressed. The drum module can not identify the type of pedal properly and it causes that the kick may produce much smaller sound than expected.

## Turning Off the Drum Module

1. If you have connected your drum module to other audio equipment, ensure that the volume on all other devices is turned down fully.
2. Press the [  ] (Standby/On) button.  
The drum module will turn off and all button lights will go out.



### NOTICE

The drum module automatically stores all current settings before it turns off. For this reason, please do not unplug the AC adaptor until all button lights have gone out.

## Auto Power-Off

The Auto Power-Off function automatically turns off the drum module after a certain period of inactivity. This helps to save energy should you forget to turn it off yourself.

### NOTE

The drum module automatically stores all current settings before it turns off.

### ● Setting the Auto Power-Off Function

You can set the amount of time that the Auto Power-Off function will wait before turning off the drum module. For details, see the description of the Auto Power-Off Time parameter from Menu Mode (page 54).

### NOTICE

- In certain modes of operation, the Auto Power-Off function will not turn off the drum module when the set time has elapsed. We recommend, therefore, that you always turn off the drum module manually when you are finished using it.
- If you expect the drum module to be inactive for a certain length of time while connected to other audio equipment, we recommend that you turn the volume on the other equipment fully down. Alternatively, you can disable the Auto Power-Off function to ensure that the drum module stays on.

### NOTE

- Settings for the Auto Power-Off function do not represent exact times and there may be some variation.
- By default, the Auto Power-Off time is set to 30 minutes.

### ● Quickly disabling Auto Power-Off

To quickly disable the Auto Power-Off function, turn on the drum module while holding down the **number button [1]**. The function will remain off until you set a new Auto Power-Off time.

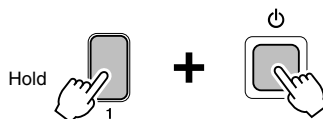

## Restoring the Default Settings (Factory Reset)

Straight out of the box, your drum module already contains a wide range of pre-programmed drum kits and songs. These default settings—collectively known as the Factory Reset—can be conveniently restored at any time if you have accidentally overwritten them or wish to delete all of your own settings. To do so, use the Factory Reset function as follows.

### NOTICE

When you restore the Factory Reset as described below, any changes you have made to parameters will be lost. Before proceeding, therefore, you should ensure that they contain no irreplaceable settings.

1. Press the [  ] (Standby/On) button and verify that the drum module turns off.
2. Turn on the drum module while holding down the **VOLUME[+] button** and the **VOLUME[-] button**.

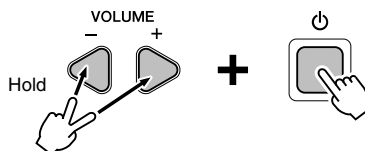

The drum module's lights will flash and the Factory Reset will be restored.



# Panel Controls & Functions

## Control Panel

### ■ Drum module

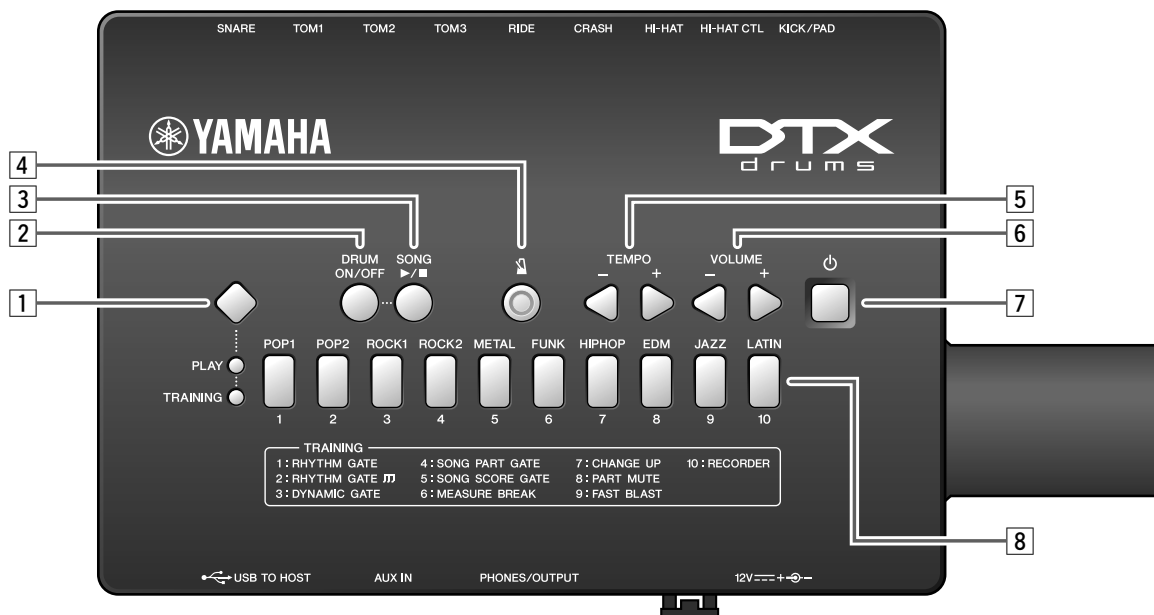

#### 1 Mode switch

- Press this switch to switch Play Mode and Training Mode. (pages 26, 31)
- Hold down this switch to select Menu Mode. (page 41)

#### 2 [DRUM ON/OFF] button (page 28)

Use this button to mute and unmute drum parts from a practice drum pattern.

#### 3 [▶/■] button

- Use this button to start and stop songs. (page 27)
- In Training Mode, it is also used to start and stop training sessions. (page 31)

#### 4 [M] (metronome) button (page 29)

- Use this button to start and stop the built-in metronome.
- In Training Mode, it is also used to start and stop training sessions.

#### 5 [TEMPO] buttons (page 30)

Use these buttons to increase or decrease the tempo in steps of one BPM.

\*: In Menu Mode, it is also used to increase or decrease settings.

#### 6 [VOLUME] buttons (page 26)

Use these buttons to adjust the overall volume of the drum module. Press the [+] **button to increase it and the [-] **button to decrease it.****

#### 7 [⏻] (Standby/On) button (page 22)

Use this button to turn the drum module on and off.

#### 8 Number buttons

- Use these buttons to select music categories and training types. (pages 27, 31)
- They are also used to enter a tempo directly. (page 30)
- In Menu Mode, they are used to select settings. (page 41)
- Also in Menu Mode, they are used to enter setting values directly. (page 41)

## Bottom Panel

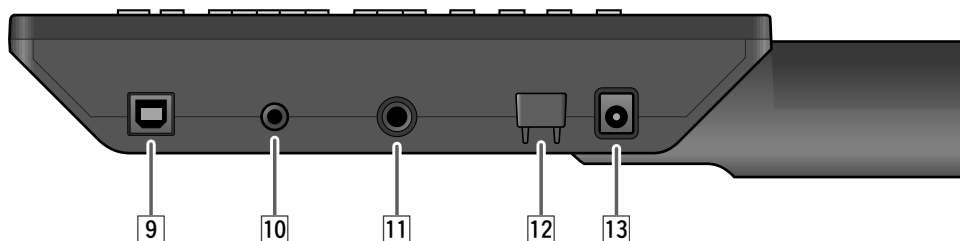

### 9 [USB TO HOST] terminal (page 58)

Connect a computer or smart device such as an iPhone or iPad to send and receive digital signals (audio and MIDI).

Additional parts are required for connecting an iPhone or iPad. For more information, refer to “iPhone/iPad Connection Manual” (PDF).

### 10 [AUX IN] jack (page 21)

The Auxiliary Input stereo mini-jack is used to input audio from an external source. For example, you can use this jack to connect a portable music player or another similar device and play along with your favorite tunes.

### 11 [PHONES/OUTPUT] jack (page 21)

Use this standard stereo-audio jack to connect headphones, an amplifier, a mixer, or other similar equipment.

### 12 Cord clip (page 21)

Wrap the AC adaptor cord around this clip to prevent accidental unplugging during use.

### 13 [ 12V + - ] connector (page 21)

Use this connector for the AC adaptor that came with your drum module.

## Top Panel

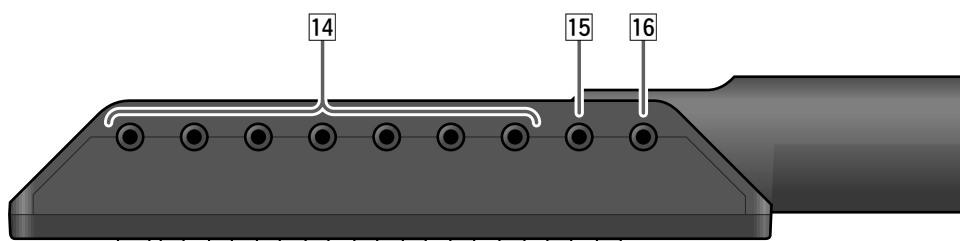

### 14 Trigger input jacks (page 20)

Use these jacks to connect the snare, tom, and cymbal pads.

### 15 [HI-HAT CTL] jack (page 20)

The Hi-hat Control jack is used to connect a hi-hat controller.

### 16 [KICK/PAD] jack (page 20)

Use this jack to connect a kick pad or pedal. By connecting a KP65, you can add another pad using the PAD ► IN jack on the KP65 (page 57).

# Playing Techniques

## Snare Pad

If using a TP70S Snare Pad with the DTX452K, you will be able to produce three distinct sounds (i.e., head, open rim, and closed rim) depending on where you strike it, much the same as if you were playing an acoustic snare.

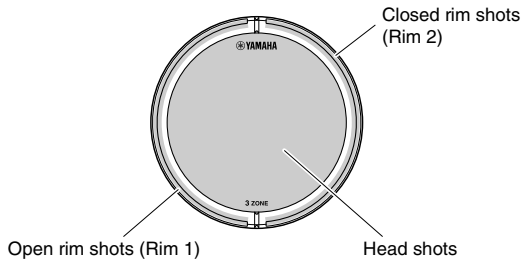

### ● Head shots

Hitting the main surface of the pad produces a head shot sound.

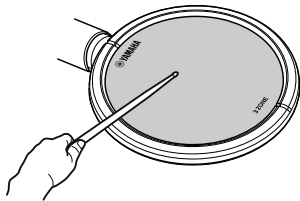

### ● Open rim shots

Hitting the open-rim zone produces an open rim-shot sound.

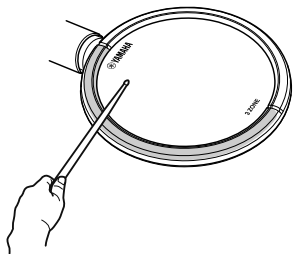

### ● Closed rim shots (cross sticking)

Hitting the closed-rim zone produces a closed rim-shot sound.

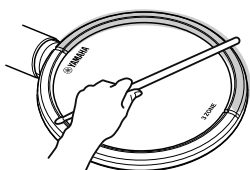

## Hi-hat Cymbal

### ● Open/close

- You can produce an open hi-hat sound by striking the hi-hat pad with the hi-hat controller's pedal not depressed.
- You can produce a closed hi-hat sound by striking the hi-hat pad with the hi-hat controller's pedal depressed.
- If using an HH65 Hi-hat Controller with the DTX432K and DTX452K, you can operate the pedal to recreate the sound of a closing hi-hat.

### ● Foot closed

You can depress the hi-hat controller's pedal to create a foot-close sound without having to strike the hi-hat pad.

#### NOTE

If using an HH40 Hi-hat Controller with the DTX402K, the velocity is fixed regardless of how strongly or softly the hi-hat controller's pedal is depressed. For adjusting the fixed velocity value, see the description of the Foot Close Velocity parameter from Memu Mode (page 47).

### ● Hi-hat splash

Depressing the hi-hat controller's pedal and then immediately releasing it produces a hi-hat splash sound.

## Crash Cymbal

### ● Choke

You can immediately mute a sound by choking (pinching) the cymbal's edge with your hand after hitting the cymbal. The Choke function only works when you grasp in the sensor area.

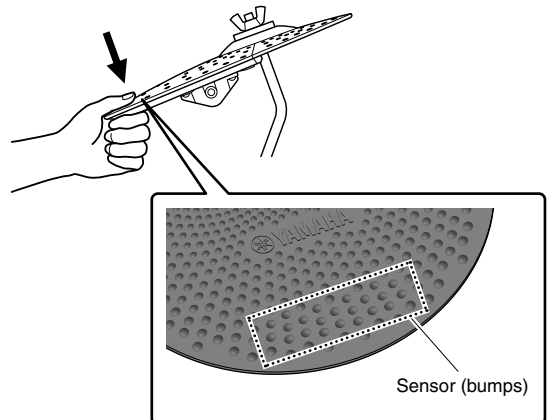

# Performing with a Selected Music Category

The drum module comes with ten different music categories. When you select a music category, the corresponding “kit” (referring to a full set of drum-sound assignments for all of the pads) and song will be automatically selected.

## Selecting a Music Category

1. Press the **Mode switch** to turn the “PLAY” light on (Play Mode).
2. Select a music category by pressing the corresponding **number button [1] to [10]**.  
The selected number button will light up and the corresponding drum or percussion kit will be automatically selected.

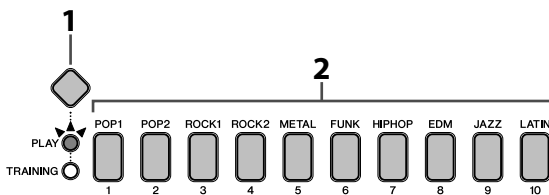

3. Play the pads and see how the kit sounds.

**NOTE**

For detailed information on the ten preset music categories, see the Data List section (page 62).

## Adjusting Kit Sensitivity

Using the following procedure, you can change the sensitivity of a kit—that is, how the drum sounds change depending on how hard you strike the pads. Sensitivity can be adjusted to ten different levels.

While holding the **Mode switch**, press either the **VOLUME[+]** or **VOLUME[-]** button.

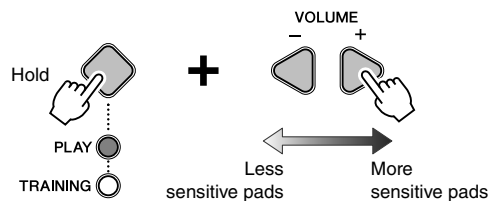

- Each time you press the **VOLUME[+] button**, you increase the sensitivity by one level. This means that louder sounds can be more easily produced with softer drumming.
- Each time you press the **VOLUME[-] button**, you decrease the sensitivity by one level. This means that louder sounds can only be produced by drumming hard.

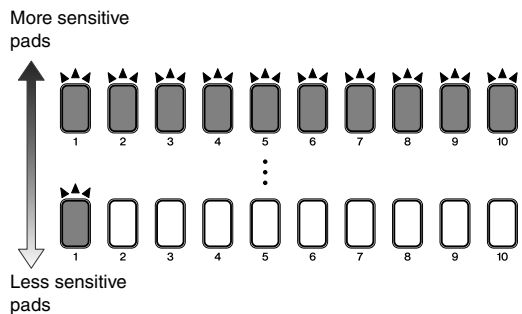

**NOTE**

- The selected sensitivity is common to the drum module’s ten kits.
- If you wish to set sensitivities on an individual pad basis, see the descriptions of the Trigger Settings parameters from Menu Mode (page 48).

## Performing with a Song

1. Press the **Mode switch** to turn the “PLAY” light on.
2. Select a music category by pressing the corresponding **number button [1] to [10]**.  
The selected number button will light up and the corresponding song will be automatically selected.

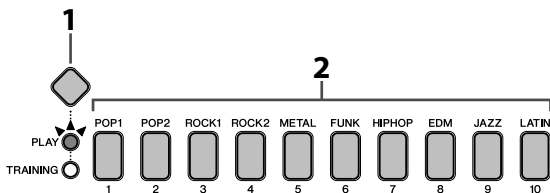

### NOTE

The score (PDF) is available at the Yamaha website:  
<https://download.yamaha.com/>

After accessing the Support website (and clicking on “Manual Library”), enter the appropriate model name.

3. Press the **[▶/■] button** to start the song.
4. Play the pads with the song.

### NOTE

If you wish to mute the programmed drum parts and hear only the song parts, press the [DRUM ON/OFF] button. To unmute the drum parts, press the [DRUM ON/OFF] button once again.

5. To stop the song, press the **[▶/■] button** once again.

## Adjusting the Song Volume

While holding the **[▶/■] button**, press either the **VOLUME[+]** or **VOLUME[-]** button.

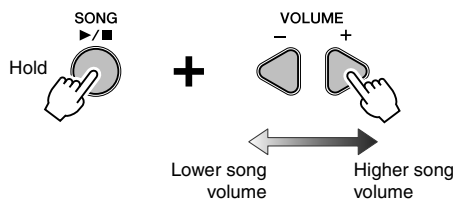

- Each time you press the **VOLUME[+]** button, you increase the song volume by one.
- Each time you press the **VOLUME[-]** button, you decrease the song volume by one.

### NOTE

The set volume is common to the drum module's ten songs.

## Adjusting the Volume of Muted Drum Parts

If you press the **[DRUM ON/OFF]** button while playing a song, the drum parts from the song will be muted—that is, their volume will be reduced to zero. If, however, you would like the drum parts to be slightly audible in this type of situation, you can adjust the muted volume as described below.

1. Press the **[▶/■]** button to start the song.



2. Press the **[DRUM ON/OFF]** button to mute the drum parts.

The button is unlit when the drum part is muted, and is lit when the drum part is played (not muted).



3. While holding the **[DRUM ON/OFF]** button, press either the **VOLUME[+]** or **VOLUME[-]** button.

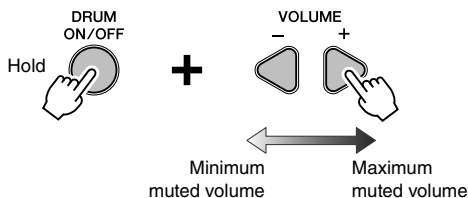

- -Each time you press the **VOLUME[+]** button, you increase the volume of the muted drums by one.
- Each time you press the **VOLUME[-]** button, you decrease the volume of the muted drums by one.

By pressing the **[DRUM ON/OFF]** button once again, you can unmute the drum parts and restore their normal volumes.

## Importing a MIDI song

Using apps compatible with the drum module, you can easily import a MIDI song on your drum module.

For details on compatible smart devices and applications, refer to the web page below.

For more information on how to connect, refer to the “iPhone/iPad Connection Manual” (PDF) on the web page below.

<https://download.yamaha.com/>

After accessing the Support website (and clicking on “Manual Library”), enter the appropriate model name.

### NOTE

- For deleting the imported MIDI song, see the description of the Delete Song parameter from Menu Mode (page 55).
- To eliminate the risk of interference due to noise by your smart device when used in combination with the drum module, turn on the Airplane Mode and then turn on Wi-Fi.

### NOTICE

Be sure to place your smart device on a stable surface to prevent it from falling over and being damaged.

# Using the Metronome

Playing your electronic drum kit along with the built-in metronome is a great way to perfect your rhythm.

## Starting and Stopping the Metronome



- Press the [M] button to turn on the metronome.
- Press the [M] button once again to turn it off.

## Adjusting the Metronome Volume

To adjust the volume of the metronome, press and hold the [M] button, and then press either the VOLUME[+] or VOLUME[-] button.

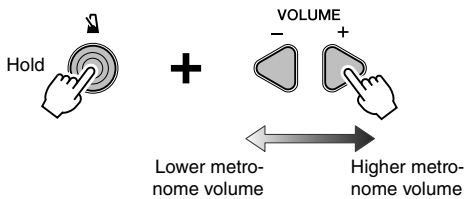

- Each time you press the VOLUME[+] button, you increase the metronome volume by one.
- Each time you press the VOLUME[-] button, you decrease the metronome volume by one.

## Confirming Tempo

Whenever necessary, you can confirm the drum module's current tempo from the flashing pattern of the number button lights and the voice guidance.

The larger the value, the faster the tempo becomes.

Press either the TEMPO[+] or TEMPO[-] button once.

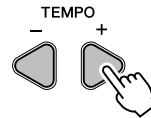

Or

Press and hold the [M] button.



Each digit of the tempo will be flashed in sequence.

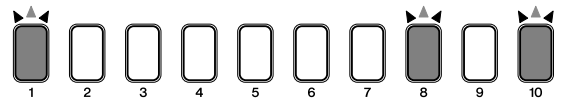

**Example:**

When the tempo is 108 BPM, the number button lights will flash [1]→[0]→[8].

**NOTE**

If you wish to turn off the voice guidance function, see 7-1. Voice Guidance Volume (page 53).

## Adjusting the Tempo

The following three methods are available when you want to change the tempo.

- Increasing or decreasing using the **TEMPO[+]** or **TEMPO[-]** button
- Directly inputting a BPM using the number buttons
- Tapping the tempo on the pads

### NOTE

- The drum module supports tempos between 30 and 300 BPM.
- If you select a different song (page 27) after adjusting the tempo, the selected song's tempo will be used for the metronome.

### ■ Increasing or decreasing using the **TEMPO[+]** or **TEMPO[-]** button

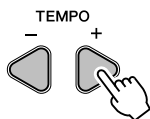

- Each time you press the **TEMPO[+]** button, you increase the metronome BPM by one.
- Each time you press the **TEMPO[-]** button, you decrease the metronome BPM by one.

### ■ Directly inputting a BPM using the number buttons

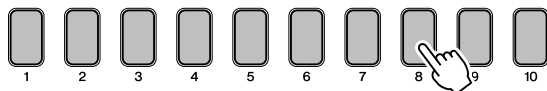
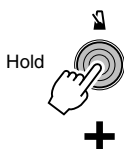

1. While holding the **[TEMPO[-]]** button, enter the BPM using the **number buttons**.

The drum module will speak the input tempo to you (in English).

#### Example: Setting a tempo of 138 BPM

Press the number buttons in the sequence [1]→[3]→[8].

2. After entering all necessary digits, remove your finger from the **[TEMPO[-]]** button.

The drum module will speak the new tempo to you (in English).

### NOTE

- Number button [10] is used to enter the value zero. You cannot use it to enter the number ten.

#### Example: Setting a tempo of 110 BPM

Press the number buttons in the sequence

[1]→[1]→[10].

You cannot do this by pressing [1]→[10].

- There is no need to enter a zero first in order to set a two-digit tempo.

#### Example:

To set a tempo of 72 BPM, simply press the number buttons in the sequence [7]→[2]. You do not need to press [10]→[7]→[2].

- Whenever the drum module is speaking the tempo, you can enter a new tempo directly using the number buttons but without having to hold down the **[TEMPO[-]]** button.

### ■ Tapping the tempo on the pads

1. While holding the **[TEMPO[-]]** button, strike a pad at least three times at the desired tempo.

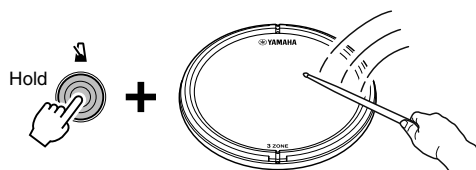

2. Remove your finger from the **[TEMPO[-]]** button.

The drum module will speak the new tempo to you (in English).

### NOTE

Instead of using a pad, you can also tap the tempo by pressing the **TEMPO[+]** or **TEMPO[-]** button at least three times.

## Other Settings

The following metronome-related settings can be made in Menu Mode. For details, see the description of the Metronome Settings parameter group from Menu Mode (page 42).

- Metronome pattern
- Metronome length in beats
- Metronome sound
- Number-button lighting pattern when using the metronome



# Practicing in Training Mode

With ten different types of training available, you can learn how to play drums and master them in an enjoyable way.

## Basic training

### Working on your rhythm:

- Rhythm Gate (2 types) . . . . . page 32
- Measure Break . . . . . page 36
- Change Up . . . . . page 37

### Playing with dynamics:

- Dynamic Gate . . . . . page 33

### Playing as fast as you can:

- Fast Blast . . . . . page 39

### Practicing by parts:

- Part Mute . . . . . page 38

### Recording your play:

- Recorder . . . . . page 40

## Advanced training

— Going on to mastery after Basic training! —

### Playing along with a song:

- Song Part Gate . . . . . page 34
- Song Score Gate . . . . . page 35



## Before Training

Before starting, please select your desired music category.

1. Press the **Mode switch** to turn the “PLAY” light on.
2. Select a music category by pressing the corresponding **number button**.

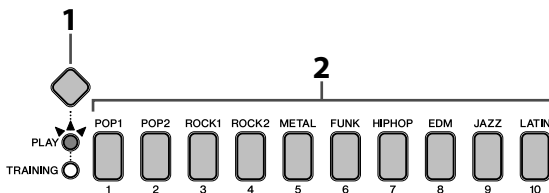

## Detailed Training settings

You can make detailed settings for Training, such as the practice timer and the difficulty level in Menu Mode (page 41).

## After Training

For the following training exercises, the drum module evaluates your ability on a scale of one to ten and displays the results using the number buttons.

- Rhythm Gate
- Dynamic Gate
- Song Score Gate
- Change Up

Number button [10] represents the highest score, while number button [1] represents the lowest. In addition, the Voice Guidance announces the results of scoring using the five levels shown below. Try your best to get a high score!

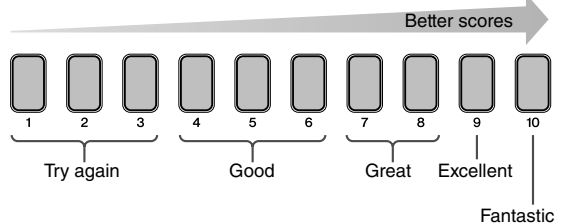

## Switching to a different exercise

To start a different exercise, you need to reenter the training mode.

1. Press the **Mode switch** to turn the “PLAY” light on (Play Mode).
2. Press the **Mode switch** again to turn the “TRAINING” light on (Training Mode).

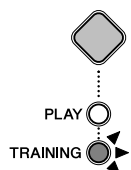

### Working on your rhythm:

## 1. RHYTHM GATE, 2. RHYTHM GATE

Rhythm Gate is an exercise for improving your timing along with a song or the metronome. When you strike with perfect timing, the number buttons [5] and [6] flash together. When you strike too early or too late, no sound is produced. Using Rhythm Gate can greatly help you improve your sense of rhythm!

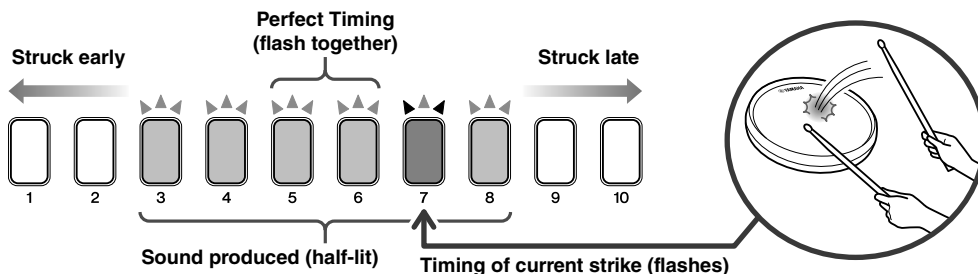



### Procedure

1. Press the **Mode switch** to turn the “TRAINING” light on (Training Mode).



**NOTE**

When the “TRAINING” light is ON, press the Mode switch to turn on the “PLAY” button, and then press the Mode switch again to turn on the “TRAINING” light.

2. Press **number button [1]** or **[2]** to select Rhythm Gate. [1] is for a sixteenth-note rhythm exercise and [2] is for a triplet  rhythm exercise.

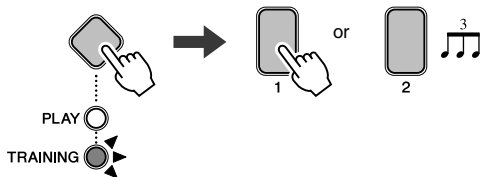
The  button and  button flash, indicating that the drum module is set to standby.



3. If you press the  button, the current song will be used for the exercise. If you press the  button, the metronome will be used.

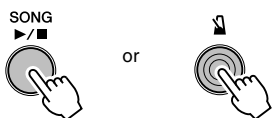

**NOTE**

Please change the beats of the metronome, as needed.

4. Play the pads as rhythmically “tight” as you can along with the song or the metronome.

5. To end the exercise, press the button used to start it in **Step 3**.

Your score will be displayed. (For details, see page 31.)

### TIPS

- Pressing the **number buttons [2] to [9]** in standby or Training Mode allows you to change the range of that sound is produced when you strike. The narrower the range, the higher the difficulty level.

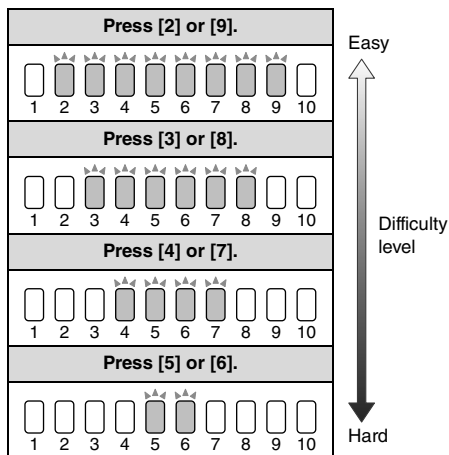

- The direction of the timing indicators for showing “too slow” to “too fast” can be reversed. (Menu Mode “Rhythm Gate indicator flipped”; page 52.)
- The exercise time can be adjusted. (Menu Mode “Timer”; page 51.)
- You can set whether the pads produce sound whenever they are struck or only when they are struck exactly in time. (Menu Mode “Ignore Timing”; page 51.)

## Playing with dynamics:

### 3. DYNAMIC GATE

Dynamic Gate is an exercise for playing pads with proper dynamics. Your aim is to control three levels: Weak, Normal and Strong. When you strike with the wrong dynamics, it will not produce any sound. How accurately you strike with the proper dynamics is evaluated at the end of the exercise. Once you master Dynamic Gate, you will be a skillful drummer at controlling dynamics depending on the situation!

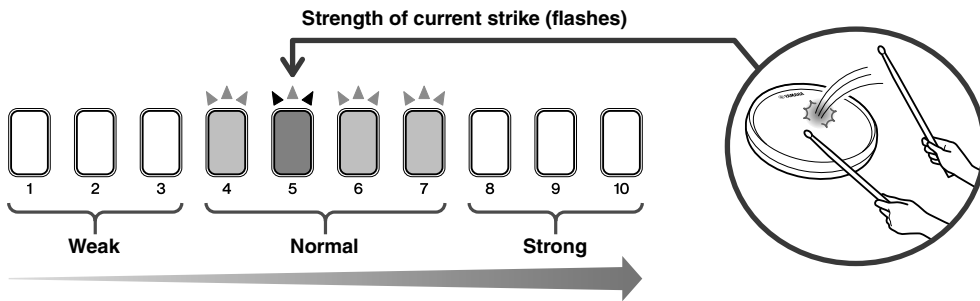

## Procedure

1. Press the **Mode switch** to turn the “TRAINING” light on.

#### NOTE

When the “TRAINING” light is ON, press the Mode switch to turn on the “PLAY” button, and then press the Mode switch again to turn on the “TRAINING” light.

2. Press **number button [3]** to select Dynamic Gate. The **[▶/■]** button flashes, indicating that the drum module is set to standby.

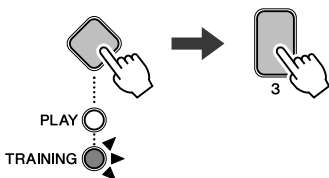

3. Strike the desired pad for practicing.
4. Press **number buttons [1] or [10]** to select the level. [1] to [3] is “weak,” [4] to [7] is “normal,” and [8] to [10] is “strong.” The number buttons in the selected level become half lit.

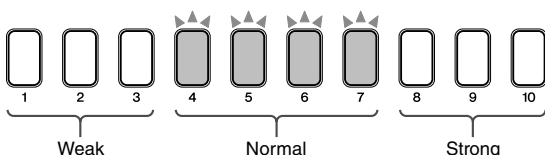

5. Press the **[▶/■]** button to start the exercise.



6. Strike the pad you chose in **Step 4** with proper dynamics.
7. To end the exercise, press the **[▶/■]** button. Your score will be displayed. (For details, see page 31.)

## TIPS

- The range of the dynamics can be adjusted. (Menu Mode “Dynamic Gate Low Limit” and “Dynamic Gate High Limit”; page 52.)
- The exercise time can be adjusted. (Menu Mode “Timer”; page 51.)

## Playing along with a song:

### 4. SONG PART GATE

Song Part Gate is an advanced exercise for playing actual drum patterns along with a part of a song. For example, you can practice just the fill-in part in the song, or only the hand parts of the basic drum pattern of the song. Before working on Song Part Gate, it would be better to master the other basic training programs. Then once you master Song Part Gate, you can confidently work on Song Score Gate (page 35) for playing the entire song!

#### NOTE

The score (PDF) is available at the Yamaha website:

<https://download.yamaha.com/>

After accessing the Support website (and clicking on "Manual Library"), enter the appropriate model name.



## Procedure

1. Press the **Mode switch** to turn the "TRAINING" light on.

#### NOTE

When the "TRAINING" light is ON, press the Mode switch to turn on the "PLAY" button, and then press the Mode switch again to turn on the "TRAINING" light.

2. Press **number button [4]** to select Song Part Gate. The **[▶/■]** button flashes, indicating that the drum module is set to standby.

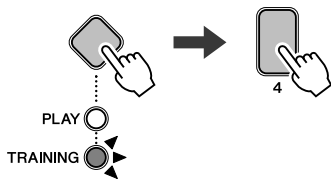

3. Press the corresponding **number button** to select the way to practice

#### NOTE

The available exercises may differ depending on the current music category. For details, refer to the Score (PDF).

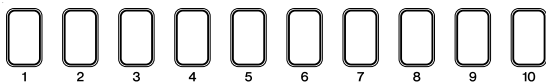

4. Press the **[▶/■]** button to start the exercise. The song will be played.

5. Play the practice drum pattern on the pads.

6. To end the exercise, press the **[▶/■]** button.



## Scoring

Your score will be announced by the voice guidance after every time the practice drum pattern is repeated. The total score is not evaluated after ending the exercise.

### TIPS

- The music category can be changed (by holding down the corresponding **number button**).
- The volume of the practice pattern can be adjusted. (While holding down the **[▶/■]** button, press the **VOLUME+[/-]** button.)
- You can mute specific parts of the practice drum pattern.
  - The mute settings are effective while the **[DRUM ON/OFF]** button is half-lit.
  - While the song is being played, strike the pad corresponding to the part you wish to mute. The selected part will be muted.
  - If the pad corresponding to the muted drum part is not struck for certain period of time, it will be automatically unmuted.
  - Press the **[DRUM ON/OFF]** button (so that it is fully lit) to end the mute settings.
- The exercise time can be adjusted. (Menu Mode "Timer"; page 51.)
- The difficulty of the exercise can be adjusted. (Menu Mode "Difficulty Level"; page 51.)
- You can set whether the pads produce sound whenever they are struck or only when they are struck exactly in time. (Menu Mode "Ignore Timing"; page 51.)

## Playing along with a song:

### 5. SONG SCORE GATE

Song Score Gate is a final exercise for playing actual drum patterns along with an entire song. Before working on Song Score Gate, we recommend that you first master Song Part Gate (page 34) as much as possible—and get you on your way to be a great drummer!

#### NOTE

The score (PDF) is available at the Yamaha website:

<https://download.yamaha.com/>

After accessing the Support website (and clicking on “Manual Library”), enter the appropriate model name.



## Procedure

1. Press the **Mode switch** to turn the “TRAINING” light on.

#### NOTE

When the “TRAINING” light is ON, press the Mode switch to turn on the “PLAY” button, and then press the Mode switch again to turn on the “TRAINING” light.

2. Press **number button [5]** to select Song Score Gate. The **[▶/■]** button flashes, indicating that the drum module is set to standby.

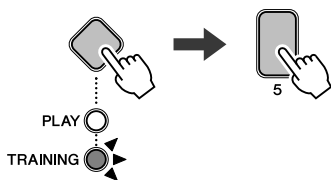

3. Press the **[▶/■]** button to start the exercise.



4. Play the drum pattern on the pads.  
After you play the entire song, your score will be displayed. (For details, see page 31.)
5. To stop the exercise, press the **[▶/■]** button.  
When you stop the exercise before the end of the song, the score for your exercise will not be shown.

## TIPS

- You can change the music category (by pressing a corresponding number key).
- The volume of the song can be adjusted. (While holding down the **[▶/■]** button, press the **VOLUME[+]/[-]** button.)
- You can mute specific parts of the practice drum pattern.
  - The mute settings are effective while the **[DRUM ON/OFF]** button is half-lit.
  - While the song is being played, strike the pad corresponding to the part you wish to mute. The selected part will be muted.
  - If the pad corresponding to the muted drum part is not struck for certain period of time, it will be automatically unmuted.
  - Press the **[DRUM ON/OFF]** button (so that it is fully lit) to end the mute settings.
- The difficulty of the exercise can be adjusted. (Menu Mode “Difficulty Level”; page 51.)
- You can set whether the pads produce sound whenever they are struck or only when they are struck exactly in time. (Menu Mode “Ignore Timing”; page 51.)

## Working on your rhythm:

## 6. MEASURE BREAK

Measure Break is an exercise for keeping a steady tempo without the metronome. How accurately you strike the first beat of the measure after the break is evaluated. Once you master Measure Break, you can keep a steady tempo even after breaks or fill ins.

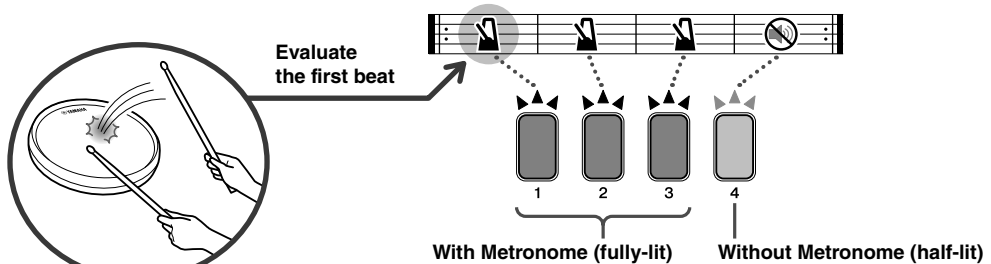

## Procedure

1. Press the **Mode switch** to turn the “TRAINING” light on.

**NOTE**

When the “TRAINING” light is ON, press the Mode switch to turn on the “PLAY” button, and then press the Mode switch again to turn on the “TRAINING” light.

2. Press **number button [6]** to select Measure Break. The **[M]** button flashes, indicating that the drum module is set to standby.

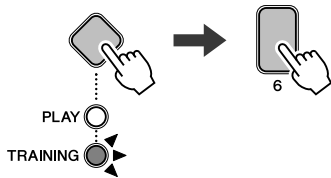

3. Press the **[M]** button to start the exercise. Four measures will be repeatedly played back. (The first to third measures are with the metronome and the fourth measure is without the metronome.) The number button flashes along with playback of the corresponding measure.



4. Play the pads.
5. To end the exercise, press the **[M]** button.

## Scoring

How exactly you strike the first beat of the measure after the break will be announced by the voice guidance after every four measures are repeated. The total score is not evaluated after ending the exercise.

## TIPS

- The total number of measures can be changed: While in standby or during the exercise, hold down the **number buttons [2] to [10]** corresponding to the desired total number of measures. For example, by holding down **[10]**, 10 measures are repeated.
- The number of measures without the metronome can be changed: While in standby or during the exercise, press the **number button** corresponding to the number of the measure. For example, if the total number of measures is set to 10, and you press **[6]**, the first to sixth measures are with the metronome and the seventh to tenth measures are without the metronome. However, keep in mind that the last measure is always without the metronome.
- The exercise time can be adjusted. (Menu Mode “Timer”; page 51.)

## Working on your rhythm:

### 7. CHANGE UP

Change Up is an exercise for playing seven different rhythms that change every two measures. How well you maintain good timing along with the rhythms is evaluated. Try your best to keep a steady tempo—even when the rhythms change!

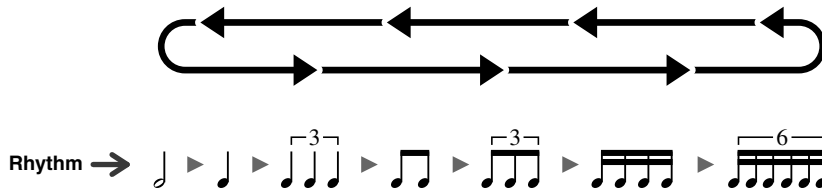

## Procedure

1. Press the **Mode switch** to turn the “TRAINING” light on.

#### NOTE

When the “TRAINING” light is ON, press the Mode switch to turn on the “PLAY” button, and then press the Mode switch again to turn on the “TRAINING” light.

2. Press **number button [7]** to select Change Up. The **[▶/■]** button flashes, indicating that the drum module is set to standby.

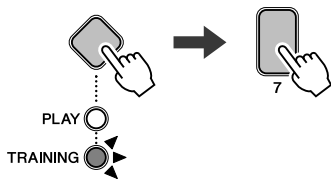

3. Press the **[▶/■]** button to start the exercise. The practice rhythm and the metronome start to play, and the rhythm changes after every two measures.



4. Play the practice rhythm on the pads.
5. To end the exercise, press the **[▶/■]** button. Your score will be displayed. (For details, see page 31.)

## TIPS

- The volume of the practice rhythm can be adjusted. (While holding down the **[▶/■]** button, press the **VOLUME+]/[-]** button.)
- The practice rhythm can be muted. (Press the **[DRUM ON/OFF]** button. To unmute, press it again.)
- You can skip among the seven rhythms as you practice by pressing the corresponding **number buttons** as shown below. The number button corresponding to the rhythm to be skipped is half lit.

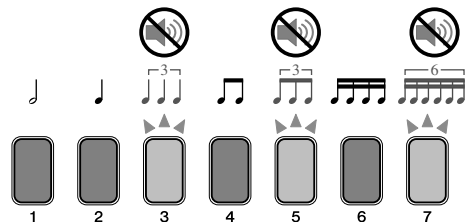

- By default, each rhythm changes after every two measures. The number of measures can be changed by pressing **[10]** several times. (Four measures when **[10]** is half lit, one measure when **[10]** is fully lit, and two measures (default) when **[10]** is off.)
- The exercise time can be adjusted. (Menu Mode “Timer”; page 51.)
- The difficulty of the exercise can be adjusted. (Menu Mode “Difficulty Level”; page 51.)
- You can set whether the pads produce sound whenever they are struck or only when they are struck exactly in time. (Menu Mode “Ignore Timing”; page 51.)

## Practicing by parts:

## 8. PART MUTE

Part Mute is an exercise which you can mute any or all of the drum parts (such as snare and kick) and the instrument parts (non-drum parts) from a song. You can select the drum parts/instrument parts to be muted by pressing the corresponding number buttons. Part Mute can be useful in many ways—for example, for practicing only the snare part of a rhythm, or for tightening up your rhythm section skills by practicing only with a bass guitar sound. Keep in mind that this exercise is not scored.

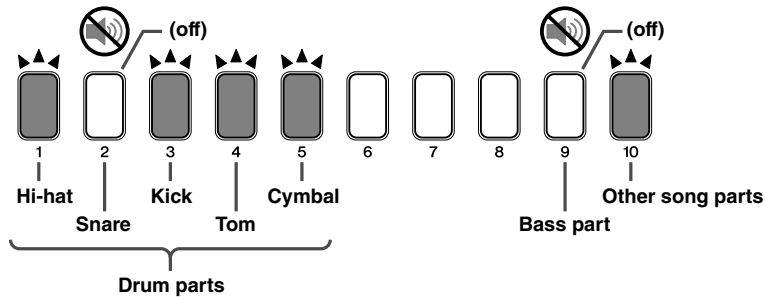

## Procedure

1. Press the **Mode switch** to turn the “TRAINING” light on.

**NOTE**

When the “TRAINING” light is ON, press the Mode switch to turn on the “PLAY” button, and then press the Mode switch again to turn on the “TRAINING” light.

2. Press **number button [8]** to select Part Mute. The **[▶/■]** button flashes, indicating that the drum module is set to standby.

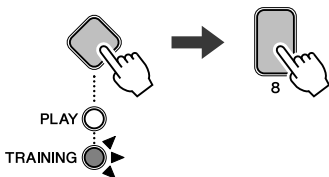

3. To mute drum parts/instrument parts, press the corresponding **number buttons [1] to [5]** or **[9] to [10]**. The number button of the muted part will be turned off (see illustration above). To unmute, press the **number button** again. The number button lights up.
4. Press the **[▶/■]** button to start the exercise.



5. Play along the song on the pads.
6. To end the exercise, press the **[▶/■]** button.

## TIPS

Drum parts can be muted by striking the pads.

- Press the **[DRUM ON/OFF] button** (so that it is half-lit).
- Strike the pad corresponding to the part from the practice drum pattern you wish to mute. The selected part will be muted and the corresponding number button will be half lit.
- If the pad corresponding to the muted drum part is not struck for certain period of time, it will be automatically unmuted and the corresponding number button will light up.
- Press the **[DRUM ON/OFF] button** (so that it is fully lit) to end the mute settings.

**NOTE**

If the part is already muted (the corresponding number button is turned off), the pad remains muted.



## Playing as fast as you can:

### 9. FAST BLAST

Fast Blast is an exercise for striking pads as fast as possible within a time limit (60 seconds). The half lit number buttons indicates the remaining time. The exercise ends when the number buttons are all turned off. The number of times you have struck will be shown by using the number buttons and also announced by the voice guidance. Try practicing your fast drumming skills as if it were a game!

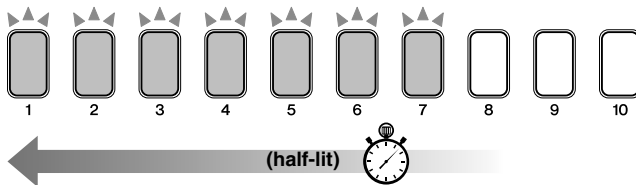

#### Procedure

1. Press the **Mode switch** to turn the “TRAINING” light on.

##### NOTE

When the “TRAINING” light is ON, press the Mode switch to turn on the “PLAY” button, and then press the Mode switch again to turn on the “TRAINING” light.

2. Press **number button [9]** to select Fast Blast. The [▶/■] button flashes, indicating that the drum module is set to standby.

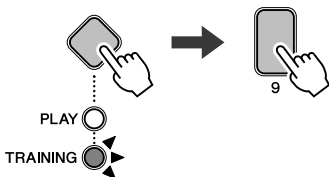

3. Press the [▶/■] button to start the exercise. The timer will start when you strike the first pad.



4. Strike pads as fast as possible. When the training has ended, your score will be displayed.
5. To stop the exercise, press the [▶/■] button.

#### Scoring

For example, if your score was 480, the number buttons would flash [4] – [8] – [10].

- Your score will be announced by the voice guidance (in English) as well.
- To check your score once again, press any of the **number buttons [1] to [10]**.

#### TIPS

The time limit can be adjusted. (Menu Mode “Fast Blast Timer”; page 53.)

## Recording your play:

## 10. RECORDER

Recorder allows you to easily record your performances. You can use those recordings not only for listening back and checking your progress, but also for playing along with yourself! Keep in mind that this training is not scored.

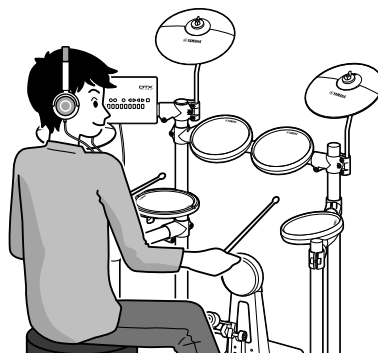

## Procedure

1. Press the **Mode switch** to turn the “TRAINING” light on.

## NOTE

When the “TRAINING” light is ON, press the Mode switch to turn on the “PLAY” button, and then press the Mode switch again to turn on the “TRAINING” light.

2. Press **number button [10]** to select Recorder. The **[▶/■]** button flashes, indicating that the drum module is set to standby.

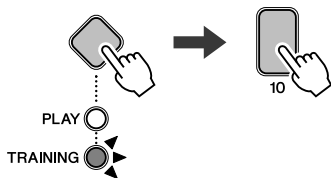

3. Play the pad, and the recording starts automatically.
4. When you finish your performance, leave all pads without striking for certain period of time. The recording will be automatically stopped and the recorded performance will be played back.
5. To end the exercise, press the Mode switch.

## TIPS

- You can play along with a song. (Press the **[▶/■]** button when the instrument is set to standby.)
- You can play with the metronome. (Press the **[M]** button when the instrument is set to standby.)
- You can stop the playback of the recording by pressing any **number button**. If you press any **number button** again, the recording will be played back from the beginning.
- The recorded performance is deleted when you exit from the Training Mode.
- The beat setting for recording is “4 beats,” and cannot be changed.

# Setting Parameters using Menu Mode

Menu Mode is used to set drum-module parameters and functions, which are arranged into the following seven groups.

## 1 Metronome Settings

1-1. Pattern .....	Page 42
1-2. Beats .....	Page 42
1-3. Sound .....	Page 42
1-4. Number Button Lighting Pattern .....	Page 43

## 2 Kit Settings

2-1. Pad Sound .....	Page 43
2-2. Pad Volume .....	Page 43
2-3. Pad Tuning .....	Page 44
2-4. Double Bass Drum .....	Page 44
2-5. Reverb .....	Page 44

## 3 MIDI Settings

3-1. Local Control .....	Page 45
3-2. Note Number .....	Page 45

## 4 Hi-hat Settings

4-1. Clutch Position .....	Page 46
4-2. Splash Sensitivity .....	Page 46
4-3. Foot Close Position .....	Page 46
4-4. Foot Close Velocity .....	Page 47
4-5. Kick Velocity .....	Page 47

## 5 Trigger Settings

5-1. Pad Velocity Curve .....	Page 48
5-2. Crosstalk .....	Page 49
5-3. Snare Pad Type .....	Page 49
5-4. Pedal Type .....	Page 50
5-5. Gain .....	Page 50
5-6. Minimum Level .....	Page 50

## 6 Training Settings

6-1. Timer .....	Page 51
6-2. Difficulty Level .....	Page 51
6-3. Ignore Timing .....	Page 51
6-4. Rhythm Gate Indicator Flipped .....	Page 52
6-5. Dynamic Gate Low Limit .....	Page 52
6-6. Dynamic Gate High Limit .....	Page 52
6-7. Fast Blast Timer .....	Page 53

## 7 Other Settings

7-1. Voice Guidance Volume .....	Page 53
7-2. Operation Sound Volume .....	Page 53
7-3. USB Audio Output Settings .....	Page 54
7-4. USB Audio Output Gain .....	Page 54
7-5. Auto Power-Off Time .....	Page 54
7-6. Stereo/Mono .....	Page 55
7-7. Initialize Kit .....	Page 55
7-8. Delete Song .....	Page 55
7-9. Revert to Last Power On .....	Page 56
7-10. Factory Reset .....	Page 56

## Basic Menu Mode Procedure

1. Hold down the **Mode switch** to turn the “PLAY” and “TRAINING” on (Menu Mode).

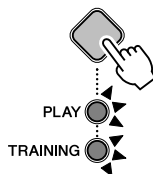

2. Press the **number button** corresponding to the group containing the parameter you wish to set. (Parameter groups are shown in the hierarchical list on the left.) To select “1-2. Beats,” for example, press the **number buttons** in the order [1]→[2].

- **When the setting value is less than 10**  
The number button of the current setting will be fully lit and the selectable number buttons will be half-lit.

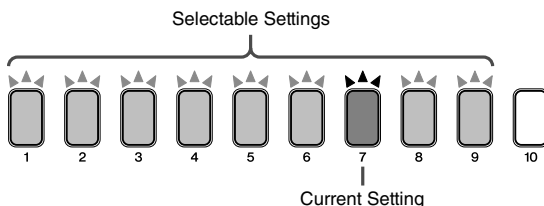

- **When the setting value is more than 10**  
The number buttons flash continuously to indicate the current setting. For example, when the current setting is 40, the number button lights will flash [4]→[10].

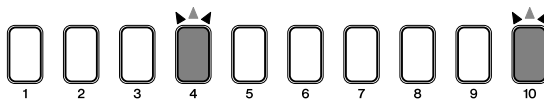

3. Enter the new setting.

- **When the setting value is less than 10**  
Select a new setting using the corresponding **number button**.
- **When the setting value is more than 10**  
Press the **TEMPO[+]/[-] button** to increase and decrease the setting values. If you take no action for a while, the setting is automatically stored.

**NOTE**

When the setting value is more than 10, you can also use the number buttons to directly set parameters with numerical values. To enter the value 105, for example, press the number buttons in the order [1]→[10]→[5]. [10] is used to enter the value zero. You cannot use [10] to enter the number ten.

# 1 Metronome Settings

## 1-1. Pattern

**Steps:**

Hold down the Mode switch → [1] → [1] → Setting

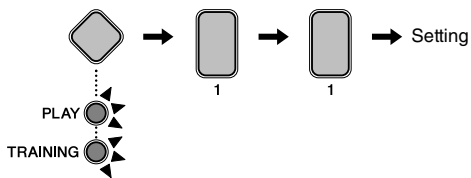

You can set one of eight patterns for the drum module's metronome.

1. Hold down the **Mode switch** to activate Menu Mode.
2. Press **number button [1]** to select the Metronome Settings parameter group.
3. Press **number button [1]** to select the Pattern parameter.
4. Select a new metronome pattern using the corresponding **number button [1] to [8]**.

Number button	Setting
[1]	
[2]	
[3]	
[4]	
[5]	3-2 Son Clave
[6]	2-3 Son Clave
[7]	3-2 Rumba Clave
[8]	2-3 Rumba Clave

## 1-2. Beats

**Steps:**

Hold down the Mode switch → [1] → [2] → Setting

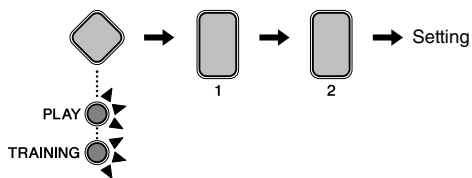

You can set the metronome to between 1 and 9 beats in length.

1. Hold down the **Mode switch** to activate Menu Mode.
2. Press **number button [1]** to select the Metronome Settings parameter group.
3. Press **number button [2]** to select the Beats parameter.
4. Select a new metronome length in beats using the corresponding **number button [1] to [9]**.

Number button	Setting
[1]	1 beat
[2]	2 beats
[3]	3 beats
[4]	4 beats
[5]	5 beats
[6]	6 beats
[7]	7 beats
[8]	8 beats
[9]	9 beats

## 1-3. Sound

**Steps:**

Hold down the Mode switch → [1] → [3] → Setting

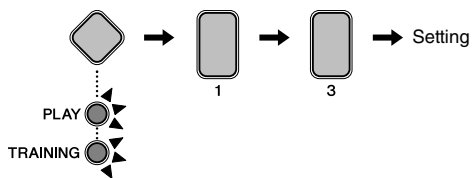

You can set the sound played by the metronome to, for example, a standard click sound, a cowbell, a drumsticks sound, or a spoken count.

1. Hold down the **Mode switch** to activate Menu Mode.
2. Press **number button [1]** to select the Metronome Settings parameter group.
3. Press **number button [3]** to select the Sound parameter.

- Select a new metronome sound using the corresponding **number button [1] to [7]**.

Number button	Setting
[1]	Metronome click 1
[2]	Metronome click 2
[3]	Cowbell
[4]	Drumsticks
[5]	Claves
[6]	Spoken count 1
[7]	Spoken count 2 (with measure number)

### 1-4. Number Button Lighting Pattern

**Steps:**  
Hold down the Mode switch → [1] → [4] → Setting

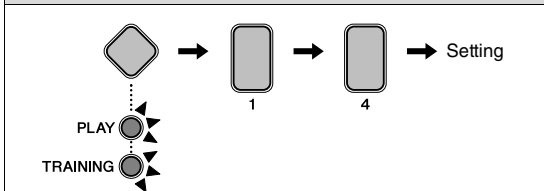

You can have number buttons [1] to [10] light up when playing the metronome in Play Mode. Use the following procedure to set the buttons' lighting pattern.

- Hold down the **Mode switch** to activate Menu Mode.
- Press **number button [1]** to select the Metronome Settings parameter group.
- Press **number button [4]** to select the Number Button Lighting Pattern parameter.
- Select a new lighting pattern using the corresponding **number button [1] to [3]**.

Number button	Setting
[1]	Off (no lighting)
[2]	Pattern 1
[3]	Pattern 2

## 2 Kit Settings

### 2-1. Pad Sound

**Steps:**  
Hold down the Mode switch → [2] → [1] → Setting

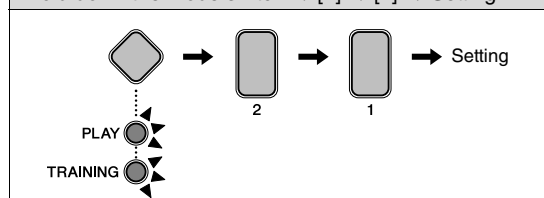

You can change the sounds assigned to the current kit's pads. This makes it very easy to create your own unique kits.

- Hold down the **Mode switch** to activate Menu Mode.
- Press **number button [2]** to select the Kit Settings parameter group.
- Press **number button [1]** to select the Pad Sound parameter.
- Strike a pad to select it.
- Enter a new drum-sound number using the **TEMPO[+]/[-] buttons**. For a list of sounds and numbers, see the Voice List (page 62).

Setting
1 to 287

### 2-2. Pad Volume

**Steps:**  
Hold down the Mode switch → [2] → [2] → Setting

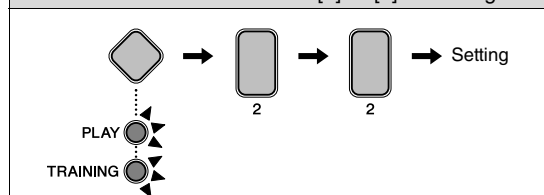

You can adjust the volume of the kit's pads.

- Hold down the **Mode switch** to activate Menu Mode.
- Press **number button [2]** to select the Kit Settings parameter group.
- Press **number button [2]** to select the Pad Volume parameter.
- Strike a pad to select it.
- Enter a new volume using the **TEMPO[+]/[-] buttons**.

Setting
0 to 127

### 2-3. Pad Tuning

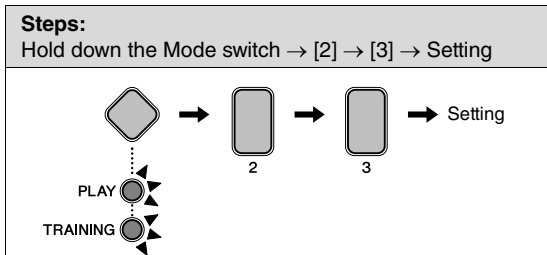

You can adjust the panning of the current kit's pads.

1. Hold down the **Mode switch** to activate Menu Mode.
2. Press **number button [2]** to select the Kit Settings parameter group.
3. Press **number button [3]** to select the Pad Panning parameter.
4. Strike a pad to select it.
5. Enter a new tuning setting using the **TEMPO[+]/[-] buttons** in 25 cent steps. The “cent” is a unit of measure for musical intervals. 100 cents make up a semitone. A value of 64 corresponds to normal pitch (0 cents).

Setting
16 (-1200 cents) to 64 (0 cent) to 112 (+1200 cents)

### 2-4. Double Bass Drum

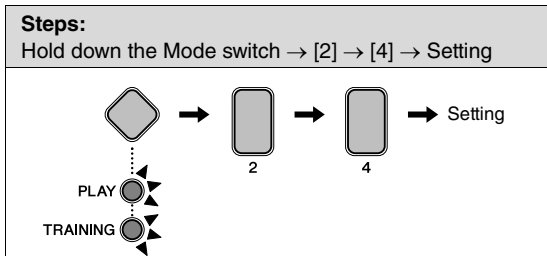

You can easily configure the drum module to produce a kick drum sound when you operate the pedal connected to the **[HI-HAT CONTROL]** trigger input jack. This convenient function provides support for double bass drumming techniques.

1. Hold down the **Mode switch** to activate Menu Mode.
2. Press **number button [2]** to select the Kit Settings parameter group.
3. Press **number button [4]** to select the Double Bass Drum parameter.

4. Set the parameter using **number button [1]** or **[2]**. The available settings are as follows.

Number button	Setting
[1]	Off
[2]	On

**NOTE**

- While the Double Bass Drum function is enabled, you will be unable to use the hi-hat controller plugged into the **[HI-HAT CONTROL]** trigger input jack to simulate opening and closing of the hi-hat.
- If using an HH40 Hi-hat Controller, you can adjust the kick velocity. For details, see 4-5. Kick Velocity (page 47).

### 2-5. Reverb

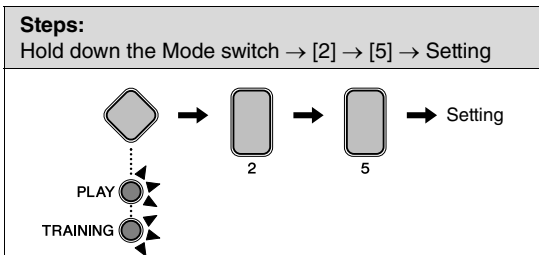

Reverb effects add a warm ambience to sounds, simulating the complex reflections of actual performance spaces, such as a concert hall or a small club. Use the following procedure to select a reverb effect for the current kit.

1. Hold down the **Mode switch** to activate Menu Mode.
2. Press **number button [2]** to select the Kit Settings parameter group.
3. Press **number button [5]** to select the Reverb parameter.
4. Select a reverb effect using the corresponding **number button [1] to [10]**.

Number button	Setting
[1]	Off
[2]	Hall
[3]	Studio
[4]	Room 1
[5]	Room 2
[6]	Stage
[7]	Small Stage
[8]	Plate
[9]	Early Reflection
[10]	Gate Reverb

## 3 MIDI Settings

### 3-1. Local Control

#### Steps:

Hold down the Mode switch → [3] → [1] → Setting

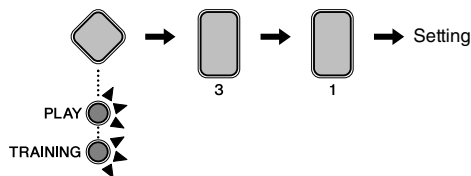

The Local Control parameter determines whether or not the drum module's internal tone generator will produce sounds in response to playing of the pads or of songs. Normally, this parameter is set to "On", meaning that pads and songs will generate sounds. When "Off" is selected, the tone generator is essentially disconnected from the pads and songs, which will be unable to generate any sound. An "Off" setting can prove highly useful when you wish to record your drum performances as MIDI data on a sequencer or using DAW software.

1. Hold down the **Mode switch** to activate Menu Mode.
2. Press **number button [3]** to select the MIDI Settings parameter group.
3. Press **number button [1]** to select the Local Control parameter.
4. Set the parameter using **number button [1]** or [2]. The available settings are as follows.

Number button	Setting	Description
[1]	Off	The internal tone generator does not respond to pads and songs.
[2]	On	The internal tone generator responds to pads and songs.

#### NOTE

- The drum module's internal tone generator will continue to respond to received MIDI data when Local Control is turned off.
- The drum module will continue to output drum performances as MIDI data when Local Control is turned off.

### 3-2. Note Number

#### Steps:

Hold down the Mode switch → [3] → [2] → Setting

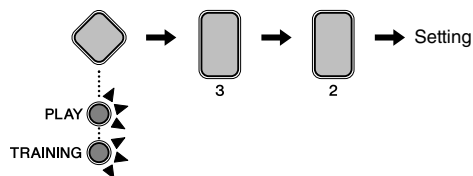

You can set the MIDI note number that is output when each of the pads is played.

1. Hold down the **Mode switch** to activate Menu Mode.
2. Press **number button [3]** to select the MIDI Settings parameter group.
3. Press **number button [2]** to select the Note Number parameter.
4. Strike a pad to select it.
5. Enter a new note number using the **TEMPO[+]/[-] buttons**.

Setting
0 to 127

#### NOTE

Note number settings are relevant only when you have connected your drum module to a computer. For more details, refer to the MIDI Reference Manual (PDF).

## 4 Hi-hat Settings

### 4-1. Clutch Position

**Steps:**

Hold down the Mode switch → [4] → [1] → Setting

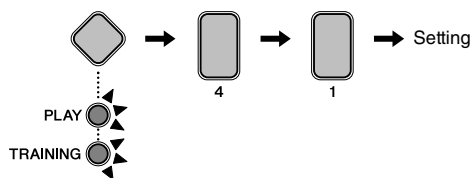

You can simulate the effect of changing the hi-hat's clutch position. The smaller the setting, the quicker an open hi-hat sound will decay.

1. Hold down the **Mode switch** to activate Menu Mode.
2. Press **number button [4]** to select the Hi-hat Settings parameter group.
3. Press **number button [1]** to select the Clutch Position parameter.
4. Enter a new clutch position using the **TEMPO+[+]/[-]** buttons.

Setting
0 to 64

### 4-2. Splash Sensitivity

**Steps:**

Hold down the Mode switch → [4] → [2] → Setting

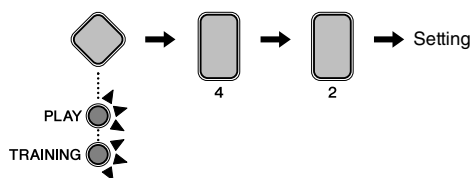

You can set the degree of sensitivity for detecting hi-hat foot splashes. The higher the value, the easier it will be to produce a foot-splash sound with the hi-hat controller. High values may, however, result in splash sounds being unintentionally produced when, for example, you operate the hi-hat controller lightly as you keep time. It is a good idea, therefore, to set this parameter to "Off" if you do not want to play foot splashes.

1. Hold down the **Mode switch** to activate Menu Mode.
2. Press **number button [4]** to select the Hi-hat Settings parameter group.
3. Press **number button [2]** to select the Splash Sensitivity parameter.

4. Enter a new splash sensitivity using the **TEMPO+[+]/[-]** buttons.

Setting
0 to 127

**NOTE**

Set this parameter to [0] in order to turn off foot splashes.

### 4-3. Foot Close Position

**Steps:**

Hold down the Mode switch → [4] → [3] → Setting

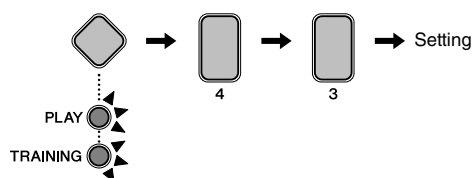

You can adjust the position at which the hi-hat switches from open to closed when you operate the hi-hat controller. The lower the value, the smaller the virtual opening between the top and bottom hi-hats. Larger values increase the size of the gap between the top and bottom cymbals, and this can prevent foot close or foot splash sounds from being produced when you operate the pedal.

This parameter only has an effect when you are using an HH65 Hi-hat Controller.

1. Hold down the **Mode switch** to activate Menu Mode.
2. Press **number button [4]** to select the Hi-hat Settings parameter group.
3. Press **number button [3]** to select the Foot Close Position parameter.
4. Enter a new foot close position using the **TEMPO+[+]/[-]** buttons.

Setting
0 to 32



#### 4-4. Foot Close Velocity

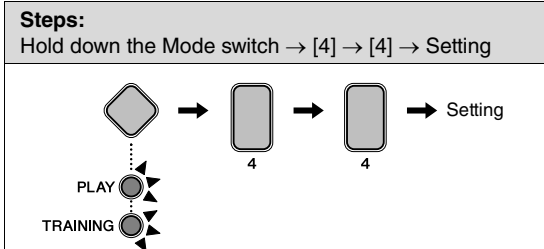

You can adjust the velocity (or power) of foot-close sounds produced using the hi-hat controller.

This parameter only has an effect when you are using an HH40 Hi-hat Controller.

1. Hold down the **Mode switch** to activate Menu Mode.
2. Press **number button [4]** to select the Hi-hat Settings parameter group.
3. Press **number button [4]** to select the Foot Close Velocity parameter.
4. Enter a new velocity using the **TEMPO[+]/[-] buttons**.

Setting
1 to 127

#### 4-5. Kick Velocity

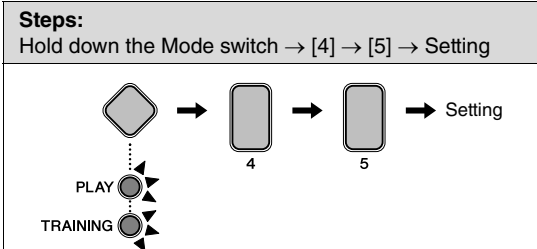

You can adjust the velocity (or power) of kick sounds produced using the hi-hat controller. In order for the Kick Velocity parameter to have an effect, Double Bass Drum must be set to “On” for the current kit (page 44).

This parameter only has an effect when you are using an HH40 Hi-hat Controller.

1. Hold down the **Mode switch** to activate Menu Mode.
2. Press **number button [4]** to select the Hi-hat Settings parameter group.
3. Press **number button [5]** to select the Kick Velocity parameter.
4. Enter a new velocity using the **TEMPO[+]/[-] buttons**.

Setting
1 to 127

## 5 Trigger Settings

### 5-1. Pad Velocity Curve

**Steps:**

Hold down the Mode switch → [5] → [1] → Setting

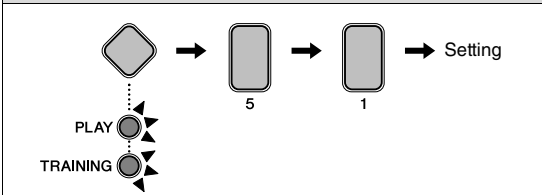

You can select a velocity curve for individual pads. A velocity curve determines how the velocity (or power) of a sound is affected by how hard you strike the pad.

1. Hold down the **Mode switch** to activate Menu Mode.
2. Press **number button [5]** to select the Trigger Settings parameter group.
3. Press **number button [1]** to select the Pad Velocity Curve parameter.
4. Strike a pad to select it.
5. Enter a new velocity curve setting using the **TEMPO[+]/[-] buttons**.

Setting
1 to 25

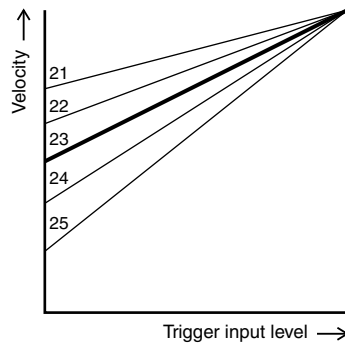
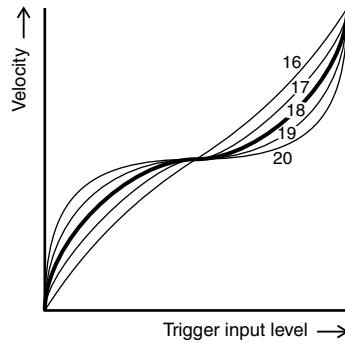
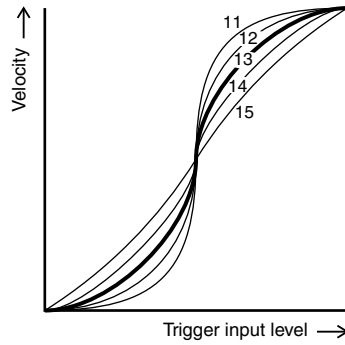
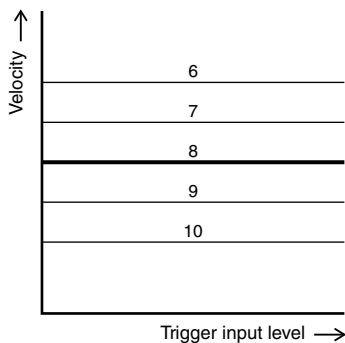
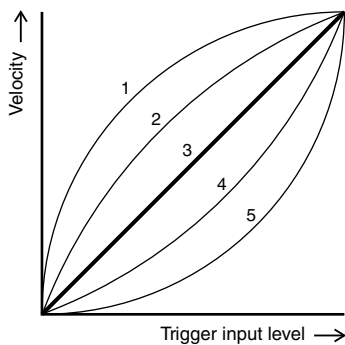

## 5-2. Crosstalk

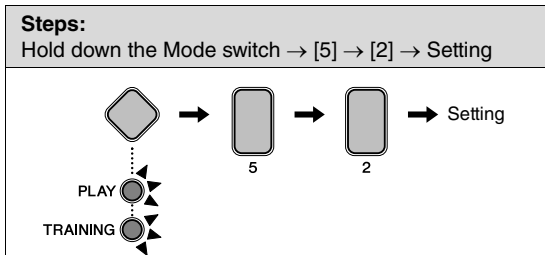

The term “crosstalk” refers to the output of spurious trigger signals from a pad other than the one that was struck as a result of vibration or interference between pads. You can adjust the Crosstalk parameter for individual pads to prevent this phenomenon from occurring.

1. Hold down the **Mode switch** to activate Menu Mode.
2. Press **number button [5]** to select the Trigger Settings parameter group.
3. Press **number button [2]** to select the Crosstalk parameter.
4. Strike a pad to select it.
5. Enter a new setting (%) using the **TEMPO[+]/[-] buttons**. Larger values are more effective in preventing crosstalk; however, they can also make it difficult to play pads simultaneously during light drumming.

Setting
0 to 99

## 5-3. Snare Pad Type

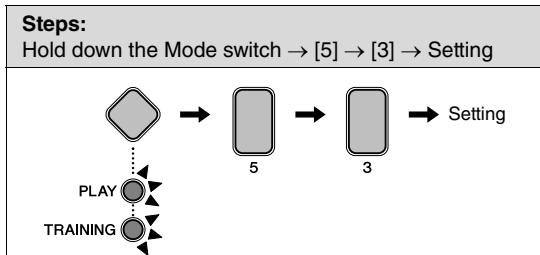

You can specify the type of snare pad connected to your drum module.

1. Hold down the **Mode switch** to activate Menu Mode.
2. Press **number button [5]** to select the Trigger Settings parameter group.
3. Press **number button [3]** to select the Snare Pad Type parameter.
4. Select a new snare pad type using the corresponding **number button [1] to [6]**.

Number button	Setting
[1]	Automatic identification (only for [2] and [3])
[2]	TP70S
[3]	Snare pad that comes with DX402K/DTX432K
[4]	XP-series pad
[5]	TP70S reversed
[6]	XP-series pad reversed

### NOTE

- When set to [1], the drum module will automatically identify the type of snare pad that came with your electronic drum kit when it is turned on. If you then press and hold number button [1], the drum module will flash number button [2] or [3] to indicate the result of automatic identification.
- Whenever you change the type of snare connected to the drum module, please update this setting using the corresponding number button [2] to [4]. For example, when you use the XP-series pad, select [4].
- You can use setting [5] or [6] to switch (or reverse) the drum sounds assigned to Rim 1 and Rim 2. This makes it easier for left-handed drummers to configure their electronic drum kit.

### 5-4. Pedal Type

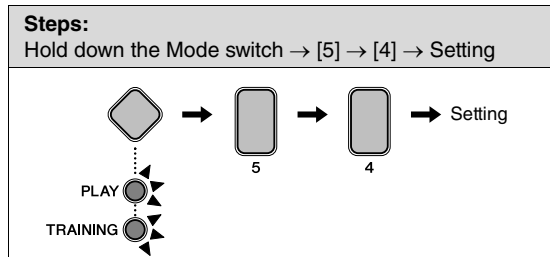

Use the following parameter to specify the types of pedals (i.e., hi-hat controller and kick) connected to your drum module.

1. Hold down the **Mode switch** to activate Menu Mode.
2. Press **number button [5]** to select the Trigger Settings parameter group.
3. Press **number button [4]** to select the Pedal Types parameter.
4. Select a new pedal type combination using the corresponding **number button [1] to [5]**.

Number button	Setting	
	Hi-hat controller	Kick pedal
[1]	Automatic identification (only for [2] and [3])	
[2]	HH65	KP65
[3]	HH40	KU100
[4]	HH40	KP65
[5]	HH65	KU100

**NOTE**

- This parameter can normally be set to [1] (automatic identification).
- When set to [1], the drum module will automatically identify the type of pedal that came with your electronic drum kit when it is turned on.  
If you then press and hold number button [1], the drum module will flash number button [2] or [3] to indicate the result of automatic identification.
- Connect the hi-hat controller before turning on the drum module. Please do not turn the drum module on with the hi-hat controller depressed. The drum module can not identify the type of pedal properly and it causes that the kick may produce much smaller sound than expected.
- Whenever you change the type of hi-hat controller or kick pedal connected to the drum module, please update this setting using the corresponding number button [2] to [5].

### 5-5. Gain

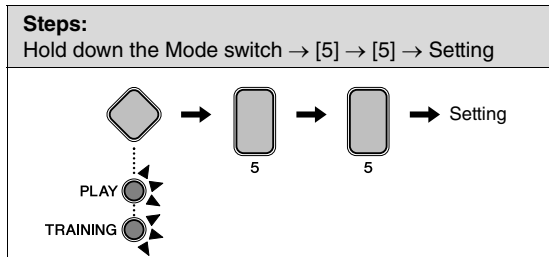

You can set the gain level for trigger signals output from individual pads. The higher the gain setting, the louder the sounds produced by light drumming.

1. Hold down the **Mode switch** to activate Menu Mode.
2. Press **number button [5]** to select the Trigger Settings parameter group.
3. Press **number button [5]** to select the Gain parameter.
4. Strike a pad to select it.
5. Enter a new gain level using the **TEMPO[+]/[-] buttons**.

Setting
1 to 127

### 5-6. Minimum Level

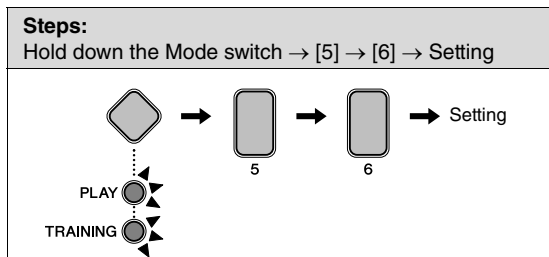

When the strength with which you strike a pad is no more than this level, the pad will not output a trigger signal in response and no sound will be produced.

1. Hold down the **Mode switch** to activate Menu Mode.
2. Press **number button [5]** to select the Trigger Settings parameter group.
3. Press **number button [6]** to select the Minimum Level parameter.
4. Strike a pad to select it.
5. Enter a new setting (%) using the **TEMPO[+]/[-] buttons**.

Setting
0 to 99 (%)

## 6 Training Settings

### 6-1. Timer

#### Steps:

Hold down the Mode switch → [6] → [1] → Setting

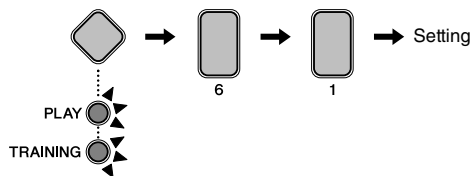

You can set the practice time for the following exercises in Training Mode.

- Rhythm Gate
- Dynamic Gate
- Song Part Gate
- Measure Break
- Change Up

The timer begins counting at the start of an exercise, and when the set time is reached, it automatically ends the exercise.

1. Hold down the **Mode switch** to activate Menu Mode.
2. Press the **number button [6]** to select the Training Settings.
3. Press the **number button [1]** to select Timer.
4. Select your preferred practice time using the **number button [1] to [10]**.

Number button	Settings
[1]	Off
[2]	30 seconds
[3]	60 seconds
[4]	90 seconds
[5]	120 seconds
[6]	150 seconds
[7]	180 seconds
[8]	300 seconds
[9]	480 seconds
[10]	600 seconds

### 6-2. Difficulty Level

#### Steps:

Hold down the Mode switch → [6] → [2] → Setting

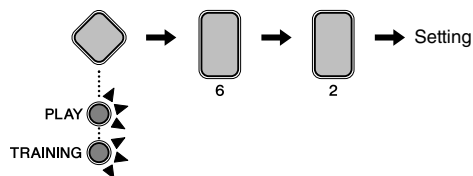

You can set the level of training difficulty for the following exercises.

- Song Part Gate
- Song Score Gate
- Change Up

1. Hold down the **Mode switch** to activate Menu Mode.
2. Press the **number button [6]** to select the Training Settings.
3. Press the **number button [2]** to select Difficulty Level.
4. Select your preferred difficulty level using the **number button [1] to [5]**. The higher the level, the more difficult the training.

Setting
1 to 5

### 6-3. Ignore Timing

#### Steps:

Hold down the Mode switch → [6] → [3] → Setting

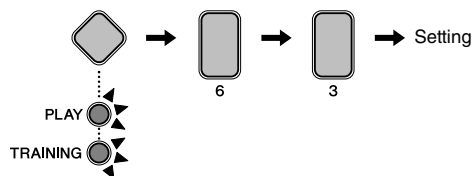



For the following trainings, you can set whether the pads produce sound whenever they are struck or only when they are struck exactly in time.

- Rhythm Gate
- Song Part Gate
- Song Score Gate
- Change Up

1. Hold down the **Mode switch** to activate Menu Mode.
2. Press the **number button [6]** to select the Training Settings.
3. Press the **number button [3]** to select Ignore Timing.

- Select the setting for each drum pad using the **number buttons [1] to [5]**. When set to producing a sound, the pad will produce a sound whenever they are struck. When set not to producing a sound, only pads played exactly in time will produce a sound.

Number button	Settings
[1] Hi-Hat	 Produce a sound (fully lit)
[2] Snare	
[3] Kick	 Not producing a sound (half lit)
[4] Tom	
[5] Cymbal	

### 6-4. Rhythm Gate Indicator Flipped

**Steps:**  
Hold down the Mode switch → [6] → [4] → Setting

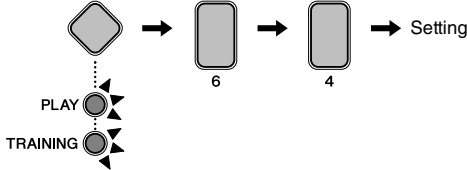

For Rhythm Gate (page 32), the time indicator using the number buttons can be reversed, according to your preference. In the normal mode, “fast” is on the left. In the reverse mode, “fast” is on the right.

- Hold down the **Mode switch** to activate Menu Mode.
- Press the **number button [6]** to select the Training Settings.
- Press the **number button [4]** to select Rhythm Gate Indicator Flipped.
- Select the mode using the **number button [1] or [2]**.

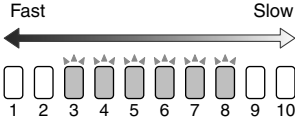
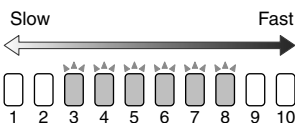
Number button	Settings	Description
[1]	Normal mode	Fast ← Slow 
[2]	Reverse mode	Slow ← Fast 

### 6-5. Dynamic Gate Low Limit

**Steps:**  
Hold down the Mode switch → [6] → [5] → Setting

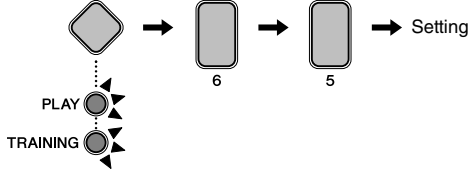

For Dynamic Gate (page 33), you can set the low limit (the threshold value between “Weak” and “Normal”).

- Hold down the **Mode switch** to activate Menu Mode.
- Press the **number button [6]** to select the Training Settings.
- Press the **number button [5]** to select Dynamic Gate Low Limit.
- Set the threshold value using the **TEMPO+[+]/[-] buttons**.

Setting
2 to 99

**NOTE**

This setting may be automatically fixed so as not to exceed the setting value of Dynamic Gate High Limit.

### 6-6. Dynamic Gate High Limit

**Steps:**  
Hold down the Mode switch → [6] → [6] → Setting

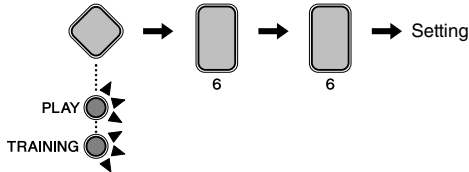

For Dynamic Gate (page 33), you can set the high limit (the threshold value between “Normal” and “Strong”).

- Hold down the **Mode switch** to activate Menu Mode.
- Press the **number button [6]** to select the Training Settings.
- Press the **number button [6]** to select Dynamic Gate High Limit.
- Set the threshold value using the **TEMPO+[+]/[-] buttons**.

Setting
2 to 99

**NOTE**

This setting may be automatically fixed so as not to be below the setting value of Dynamic Gate Low Limit.

## 6-7. Fast Blast Timer

### Steps:

Hold down the Mode switch → [6] → [7] → Setting

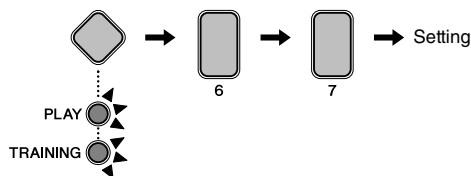

You can set the practice timer for Fast Blast (page 39). The timer begins counting at the start of an exercise, and when the set time is reached, it automatically ends the exercise.

1. Hold down the **Mode switch** to activate Menu Mode.
2. Press the **number button [6]** to select the Training Settings.
3. Press the **number button [7]** to select Fast Blast Timer.
4. Select your preferred practice time using the **number button [1] to [10]**.

Number button	Settings
[1]	Off
[2]	10 seconds
[3]	30 seconds
[4]	60 seconds
[5]	90 seconds
[6]	120 seconds
[7]	180 seconds
[8]	300 seconds
[9]	480 seconds
[10]	600 seconds

## 7 Other Settings

### 7-1. Voice Guidance Volume

#### Steps:

Hold down the Mode switch → [7] → [1] → Setting

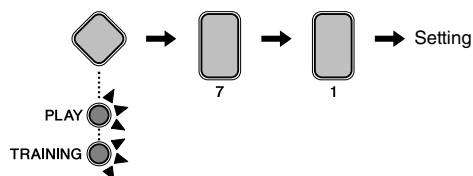

1. Hold down the **Mode switch** to activate Menu Mode.
2. Press the **number button [7]** to select the Other Settings.
3. Press the **number button [1]** to select Voice Guidance Volume.
4. Set your preferred volume using the **number button [1] to [10]**.

Setting
1 to 10

#### NOTE

Setting this parameter to [1] turns off the Voice Guidance.

### 7-2. Operation Sound Volume

#### Steps:

Hold down the Mode switch → [7] → [2] → Setting

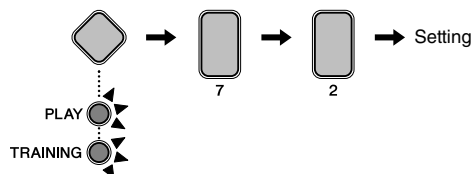

1. Hold down the **Mode switch** to activate Menu Mode.
2. Press the **number button [7]** to select the Other Settings.
3. Press the **number button [2]** to select Operation Sound Volume.
4. Set your preferred volume using the **number button [1] to [10]**.

Setting
1 to 10

#### NOTE

Setting this parameter to [1] turns off the Operation Sound.

### 7-3. USB Audio Output Settings

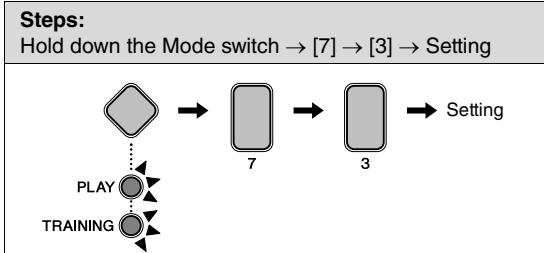

You can set whether the USB audio input is sent to the USB out or not. When set to “Output,” the audio data input from a PC (for example) is mixed with your pad performance and they are sent together to the USB out. When set to “Not out-put,” only your pad performance is sent to the USB out, even if the audio data is input and played from the PC.

1. Hold down the **Mode switch** to activate Menu Mode.
2. Press the **number button [7]** to select the Other Settings.
3. Press the **number button [3]** to select USB Audio Output Settings.
4. Select the parameter using the **number button [1] or [2]**.

Number button	Setting
[1]	Not output
[2]	Output

### 7-4. USB Audio Output Gain

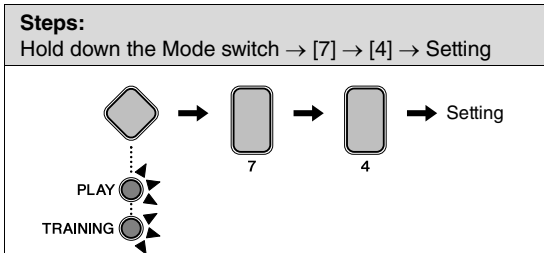

When USB Audio Output Setting is set to “Output,” you can set the output gain level.

1. Hold down the **Mode switch** to activate Menu Mode.
2. Press the **number button [7]** to select the Other Settings.
3. Press the **number button [4]** to select USB Audio Output Gain.
4. Select the gain level using the **number button [1] to [5]**.

Number button	Setting
[1]	-12 dB
[2]	-6 dB
[3]	0 dB
[4]	+6 dB
[5]	+12 dB

### 7-5. Auto Power-Off Time

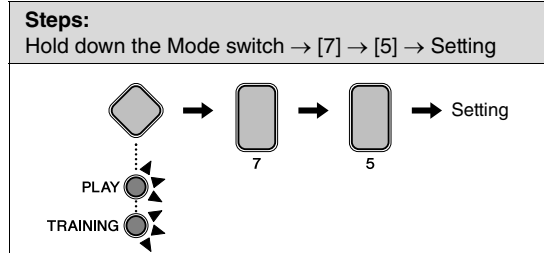

You can set the time until the Auto Power-Off function (page 22) activates or you can disable this function.

1. Hold down the **Mode switch** to activate Menu Mode.
2. Press the **number button [7]** to select the Other Settings.
3. Press the **number button [5]** to select Auto Power-Off Time.
4. Set a time or disable this function using the **number button [1] to [7]**.

Number button	Setting
[1]	Auto Power-Off disabled
[2]	5 minutes
[3]	10 minutes
[4]	15 minutes
[5]	30 minutes (default)
[6]	60 minutes
[7]	120 minutes



## 7-6. Stereo/Mono

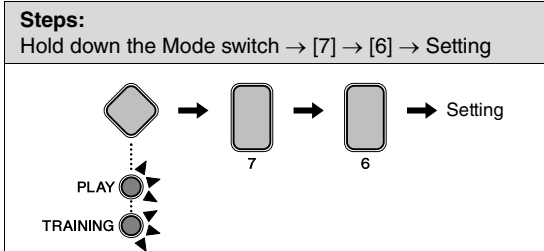

You can set the [PHONES/OUTPUT] jack to output either mono or stereo sound. We recommend that you select the Mono setting if connecting a standard mono-audio cable to this jack in order to use your drum module with external speakers, a mixer, or other similar equipment.

1. Hold down the **Mode switch** to activate Menu Mode.
2. Press the **number button [7]** to select the Other Settings.
3. Press the **number button [6]** to select Stereo/Mono.
4. Select Stereo/Mono using the **number button [1] or [2]**.

Number button	Setting
[1]	Stereo
[2]	Mono

## 7-7. Initialize Kit

You can restore a drum kit's default settings used for a specific music category.

### NOTICE

When you initialize a kit, all of the changes you have made to it will be lost. Before proceeding, therefore, you should ensure that the kit contains no irreplaceable settings.

1. Press the **Mode switch** to turn the "PLAY" light on.
2. Select a music category you wish to initialize the corresponding kit using the **number button [1] to [10]**.

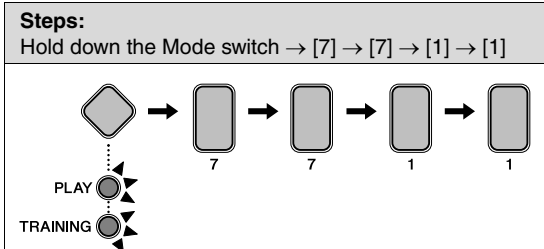

3. Hold down the **Mode switch** to activate Menu Mode.
4. Press the **number button [7]** to select the Other Settings.

5. Press the **number button [7]** to select Initialize Kit.

- The number button [1] will light up.

6. Press the **number button [1]**.

- The number button will start to flash.

- If you do not wish to proceed with initialization, press the **Mode switch** now to exit Menu Mode.

7. Press the **number button [1]**.

- The kit will be initialized.

## 7-8. Delete Song

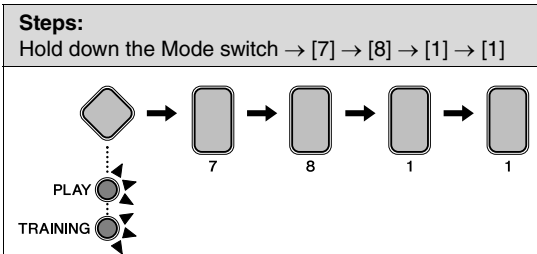

You can delete an imported MIDI song on the drum module.

### NOTICE

You cannot restore a deleted song. Before proceeding, therefore, you should ensure that the song contains no irreplaceable data.

1. Hold down the **Mode switch** to activate Menu Mode.
2. Press the **number button [7]** to select the Other Settings.
3. Press the **number button [8]** to select Delete Song.
  - The number button [1] will light up.
4. Press the **number button [1]**.
  - The number button will start to flash.
  - If you do not wish to proceed with deletion, press the **Mode switch** now to exit Menu Mode.
5. Press the **number button [1]**.
  - The song will be deleted.

## 7-9. Revert to Last Power On

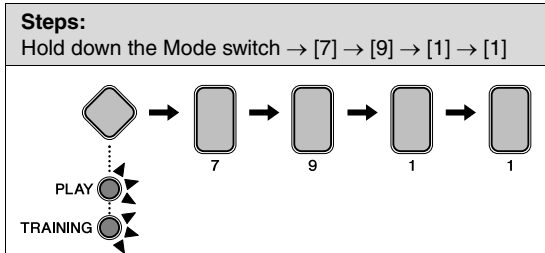

You can return all settings of drum kits, songs, and Menu Mode to the settings they had when you last turned on the drum module.

### NOTICE

- When you reset settings as described below, any changes you have made to them since last turning on the drum module will be lost. Before proceeding, therefore, you should ensure that they contain no irreplaceable settings.
- After importing or deleting a song and then changing any settings, using the “Revert to Last Power On” procedure does not restore the settings they had when you last turn on the drum module. It only restores the state before the import or delete operation.

1. Hold down the **Mode switch** to activate Menu Mode.
2. Press the **number button [7]** to select the Other Settings.
3. Press the **number button [9]** to select Revert to Last Power On.
  - The number button [1] will light up.
4. Press the **number button [1]**.
  - The number button will start to flash.
  - If you do not wish to proceed with initialization, press the **Mode switch** now to exit Menu Mode.
5. Press the **number button [1]**.
  - The settings will be initialized.

## 7-10. Factory Reset

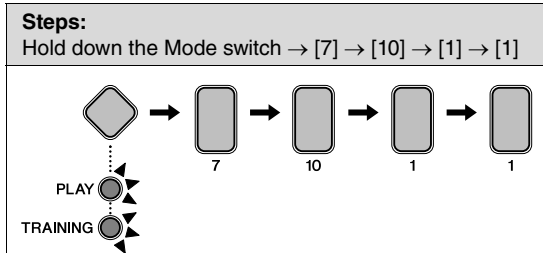

You can return all settings of drum kits, songs, and Menu Mode to their default settings.

### NOTICE

When you reset settings as described below, any changes you have made to them will be lost. Before proceeding, therefore, you should ensure that they contain no irreplaceable settings.

1. Hold down the **Mode switch** to activate Menu Mode.
2. Press the **number button [7]** to select the Other Settings.
3. Press the **number button [10]** to select Factory Reset.
  - The number button [1] will light up.
4. Press the **number button [1]**.
  - The number button will start to flash.
  - If you do not wish to proceed with initialization, press the **Mode switch** now to exit Menu Mode.
5. Press the **number button [1]**.
  - The settings will be initialized.

You can also restore the Factory Reset by turning on the drum module with the **VOLUME[+]** and **[-]** buttons held down (page 22).

# Integrating Separately Sold Accessories

As described below, you can add various accessories\* to your electronic drum kit for an even more enjoyable drumming experience. (\*: Sold separately)

Please note that these optional external pads were up-to-date as of printing of this manual. Details regarding any subsequently released models will be made available via the following web site.

<https://www.yamaha.com/dtx/>

## For DTX402K Owners

By upgrading the KU100 Kick Unit and/or the hi-hat controller included as part of the DTX402K, you can make your electronic drum kit feel much closer to the real thing.

When you upgrade your KU100 to a KP65, you will need a foot pedal to play the new kick pad.

When using a KP65, you can add pads such as a PCY95AT Cymbal Pad. (For details, refer to “Adding a PCY95AT Cymbal Pad” under “For DTX432K & DTX452K Owners.”)

### ■ Replacing the KU100 Kick Unit with a KP65 Kick Pad

1. Assemble the KP65 Kick Pad. For details, see Step 11 on page 18.
2. Turn off the drum module.  
The KP65 Kick Pad must be connected with the drum module turned off.
3. Disconnect the cable from the KU100 and plug it into the [OUT ► DTX] jack on the back on the KP65.

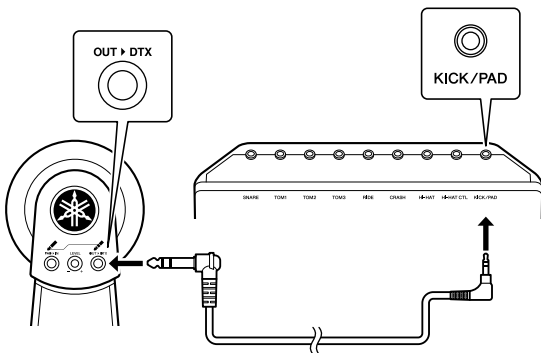

4. Turn on the drum module.
5. Set the kick type to “KP65”. For more details, see the description of the Pedal Types parameter from Menu Mode (page 50).
6. Play the KP65 Kick Pad.

### ■ Replacing the bundled hi-hat controller with an HH65 Hi-hat Controller

1. Turn off the drum module.  
The HH65 Hi-hat Controller must be connected with the drum module turned off.
2. Disconnect the cable from the bundled hi-hat controller and plug it into the [OUTPUT] jack on the HH65.
3. Turn on the drum module.
4. Set the hi-hat controller type to “HH65”. For more details, see the description of the Pedal Types parameter from Menu Mode (page 50).
5. Play the HH65 Hi-hat Controller.

## For DTX432K & DTX452K Owners

### ■ Adding a PCY95AT Cymbal Pad

1. Turn off the drum module.  
The PCY95AT Cymbal Pad must be connected with the drum module turned off.
2. Using the cable that came with the cymbal pad, connect it to the [PAD ► IN] jack on the KP65 Kick Pad.

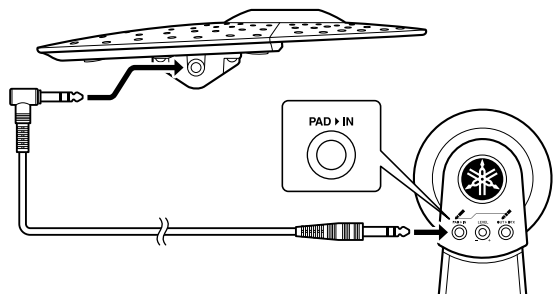

3. Turn on the drum module.
4. Play the newly added cymbal pad.

# Connecting to a Computer

Connecting the drum module to a computer or a smart device such as iPhone/iPad using a USB cable lets you send and receive audio or MIDI data. This section explains how to connect the drum module and the computer.

**NOTE**

USB cable is not included.

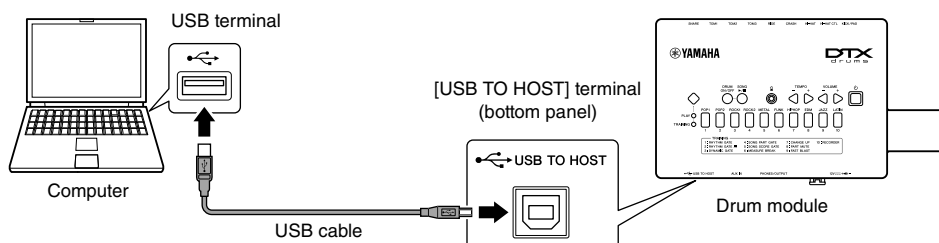

## ■ Precautions when using the [USB TO HOST] terminal

When connecting the computer to the [USB TO HOST] terminal, make sure to observe the following points. Failing to do so risks freezing the computer and corrupting or losing the data.

If the computer or the drum module freezes, restart the application software or the computer OS, or turn the power to the drum module off and then on again.

**NOTICE**

- Use an A-B type USB cable. Also, make sure the cable is less than 3 meters long. USB 3.0 cables cannot be used.
- Before connecting a computer to the [USB TO HOST] terminal, disable any power-saving mode of the computer (such as suspend, sleep, or standby).
- Before turning the power to the drum module on/off or plugging/unplugging the USB cable to/from the [USB TO HOST] terminal, quit any open application software on the computer.
- Please wait at least six seconds between turning the drum module on/off and connecting or disconnecting the USB cable.

## Installing the Yamaha Steinberg USB Driver

To use audio data with a Windows computer, you need to install the Yamaha Steinberg USB Driver.

**NOTE**

When you use a macOS computer or when you use a Windows computer only to handle MIDI data, installation of the Yamaha Steinberg USB Driver is not required.

1. Download the latest Yamaha Steinberg USB Driver from the following URL.

<https://download.yamaha.com/>

After accessing the Support website (and clicking on “Firmware/Software”), enter the appropriate model name.

Press the [ ↓ (driver name) ] button, download and open the file.

**NOTE**

- Information on system requirements is provided on the above web page.
- For improvement, the Yamaha Steinberg USB Driver may be upgraded without notice. For details and the most up-to-date information, please visit the above website.

2. Install the Yamaha Steinberg USB Driver on your computer.

For more information, please refer to the Yamaha Steinberg USB Driver Installation Guide.

## MIDI-related Reference

Information related to MIDI and creating music with a computer, is provided in the MIDI Reference Manual. The MIDI Reference Manual (PDF) is available for download at the following web page.

<https://download.yamaha.com/>

After accessing the Support website (and clicking on “Manual Library”), enter the appropriate model name.

# Troubleshooting

Some problems may be solved by restoring the default settings (Factory Reset). If the following instructions do not work, we recommend the Factory Reset (See page 22).

## No sound is produced when a pad is struck, or the volume is lower than expected.

### ■ Check connections as follows.

- Ensure that the pads are properly connected to the drum module's trigger input jacks.
- Ensure that headphones or speaker are properly connected to the [PHONES/OUTPUT] jack (not the [AUX IN] jack) on the drum module.
- Ensure that the amplifier and/or speakers connected to the drum module are turned on and are not set to the lowest possible volume.
- If you are using a KP65 Kick Pad, try adjusting its Level dial.
- Ensure that the cables you are using are in good condition.

### • For DTX402K

Ensure that an HH40 Hi-hat Controller is properly connected to the [HI-HAT CTL] jack and a KU100 Kick Unit is connected to the [KICK/PAD] jack on the drum module (page 57).

### ■ Check the drum module's settings as follows.

- Ensure that the drum module's volume is not turned fully down. Also when directly inputting the volume with numerical values by using the number buttons, try pressing the number buttons in rapid succession. (See page 41)
- Adjust the following parameters from Menu Mode.
  - Pad Volume (See page 43)
  - Gain (See page 50)
  - Pad Velocity Curve (See page 48)
  - Crosstalk (See page 49)
  - Snare Pad Type (See page 49)
  - Pedal Type (See page 50)
  - Local Control (See page 45)

### ■ If kick sounds are not produced as expected, try the following.

- Low notes may not be produced depending on the particular headphones you are using. If necessary, try different headphones.

### • For DTX402K

If you are using a KU100 Kick Unit, connect an HH40 hi-hat controller before turning on the drum module. Please do not turn the drum module on with the HH40 depressed. The drum module cannot identify the type of pedal properly and it causes that the kick may produce much smaller sound than expected.

### ■ If you cannot play foot closed hi-hat sounds, try the following.

- Ensure that you are operating the hi-hat controller in a firm and full manner.
- Ensure that the Double Bass Drum parameter from Menu Mode is set to "Off" (See page 44)
- If you are using an HH65 Hi-hat Controller, set the Foot Close Position parameter from Menu Mode to a small value. (See page 46)

**Sounds or volumes are not as expected.****■ If hi-hat splash sounds are not produced as expected, try the following.**

- Adjust the Splash Sensitivity parameter from Menu Mode. (See page 46)

**■ If it is difficult to produce closed hi-hat sounds with an HH65 Hi-hat Controller, try the following.**

- Adjust the Foot Close Position parameter from Menu Mode. (See page 46)

**■ If it is difficult to produce louder and quieter foot-closed hi-hat sounds, try the following.**

- Ensure that the Pedal Type parameter from Menu Mode is set correctly. (See page 50)

**■ For DTX402K**

If you are using an HH40 Hi-hat Controller, the velocity is fixed regardless of how strongly or softly the HH40 is depressed. Adjust the Foot Close Velocity parameter from Menu Mode. (See page 47)

**■ If pads are producing only sounds at very high volumes (i.e., high velocities), try the following.**

- Adjust the sensitivity of the drum kit. (See page 26)
- Adjust the Gain parameter from Menu Mode. High settings will result in loud drum sounds. (See page 50)
- Adjust the Pad Velocity Curve parameter from Menu Mode. (See page 48)
- Ensure that you are using only the recommended Yamaha pads. (Products from other manufacturers can output excessively large signals.)

**■ If the volumes of drum sounds produced by the various pads are poorly balanced, proceed as follows.**

- Adjust the Pad Volume parameter from Menu Mode for each pad. (See page 43)
- Ensure that the Stereo/Mono parameter from Menu Mode is set correctly. (See page 55)

**■ If the drum module's volume is not well balanced with that of the device connected to the [AUX IN] jack (such as a portable music player), proceed as follows.**

- Ensure that the volume of the connected device is set to a suitable level. (See page 21)

**■ If the volume of your drumming is not well balanced with that of a drum-module song, proceed as follows.**

- Adjust the song volume. (See page 27)

**If you notice double triggering, crosstalk, or skipped sounds (as described below), proceed as follows.****■ Double triggering—i.e., multiple sounds are produced in response to a single strike:**

- If the pad or drum trigger in question features a controller for adjusting output or sensitivity, turn it down.
- Ensure that the Pad Type parameter from Menu Mode is set correctly. (See page 49)
- Ensure that the Gain parameter from Menu Mode is not set too high. (See page 50)

**■ Crosstalk—i.e., a sound is produced by a pad other than the one that was struck:**

- Adjust the following parameters from Menu Mode.
  - Gain (See page 50)
  - Minimum Level (See page 50)
  - Crosstalk (See page 49)

**■ Skipped sounds—i.e., a pad does not produce a sound (usually during rolls or fills):**

- Adjust the Crosstalk parameter from Menu Mode to a suitable level for each affected pad. (See page 49)

### Other common questions

- **How do I make the drum module store its settings?**
  - The drum module automatically stores its settings whenever you turn it off using the [⏻] (Standby/On) button. (See page 22)
- **How do I reset all of the drum module's parameters to their default settings?**
  - You can restore default settings using the Factory Reset function. (See page 22)
- **How do I reset all of the drum module's parameters to the settings they had when I last turned it on?**
  - You can do this using the Revert to Last Power On function. (See page 56)
- **How do I reset only a desired drum kit to the default setting?**
  - Initialize the kit from Menu Mode. (See page 55)
- **How do I stop the drum module turning off while I'm using it?**
  - Disable the Auto Power-Off function. (See page 22)
- **How do I turn off the voice guidance or the operation sound?**
  - Adjust the Voice Guidance Volume parameter (page 53) or the Operation Sound Volume (page 53) to [1].
- **If choke function does not work, try the following.**
  - Ensure that you are using a crash cymbal pad with sensor. (See page 17)

\* You can also find troubleshooting tips in the MIDI Reference Manual (PDF). (See page 58)

# Data List

## ■ Music Category List

Number	Music category	Song description	Kit description
1	POP1	8-beat Pops	A versatile kit suitable for Pops.
2	POP2	16-beat Pops	A kit that simulates gated-reverb drum sounds.
3	ROCK1	8-beat Rock	A kit with powerful sounds suitable for rock music.
4	ROCK2	Rock tune with a swung rhythm	Another kit with different characteristics also suitable for rock music.
5	METAL	A heavy metal song using two bass drums	A kit with a bass drum assigned to a hi-hat controller. Useful for a double bass setup.
6	FUNK	Up-tempo funk	A kit with a distinctive hi-pitched snare drum.
7	HIPHOP	Modern Hip hop	A kit with a common setup for Modern Hip hop.
8	EDM	Electronic dance music	A kit with a common setup for electronic dance music.
9	JAZZ	4-beat Jazz	A kit with small diameter drums. Suitable for jazz.
10	LATIN	Salsa, a type of Latin music	A kit with various Latin percussion sounds.

## ■ Voice List

### Kick

- 1 MapleC 22
- 2 Big Gate
- 3 Rock
- 4 Vtg50s 22
- 5 Vtg70s 24
- 6 Metal
- 7 BirchC 22
- 8 Jazz
- 9 HipHop 1
- 10 HipHop 2
- 11 HipHop 3
- 12 HipHop 4
- 13 HipHop 5
- 14 HipHop 6
- 15 HipHop 7
- 16 HipHop 8
- 17 HipHop 9
- 18 EDM
- 19 T8-1
- 20 T8-2
- 21 T8-3
- 22 T8-4
- 23 T9-1
- 24 T9-2
- 25 T9 Hard
- 26 ElecComp
- 27 Break 1
- 28 Break 2
- 29 DNB 1
- 30 DNB 2

### Snare

- 31 MapleCustm
- 32 Big Gate
- 33 Rock
- 34 Vintage50s
- 35 Vintage70s
- 36 Metal
- 37 BirchCustm
- 38 Jazz
- 39 HipHop 1
- 40 HipHop 2
- 41 EDM
- 42 T8
- 43 T9
- 44 Analog
- 45 Gate 1
- 46 Gate 2
- 47 Gate 3
- 48 Electro 1
- 49 Electro 2
- 50 Electro 3
- 51 Electro 4
- 52 Break
- 53 DNB
- 54 Clap 1
- 55 Clap 2
- 56 Clap 3
- 57 Clap 4
- 58 Clap 5
- 59 Clap 6
- 60 Clap 7
- 61 Clap 8
- 62 Clap 9
- 63 Clap 10
- 64 Clap 11
- 65 Clap 12
- 66 Clap 13
- 67 Clap 14
- 68 Snap 1
- 69 Snap 2
- 70 Snap 3

### Tom

- 71 MapleC H
- 72 MapleC M
- 73 MapleC L
- 74 Big Gate H
- 75 Big Gate M
- 76 Big Gate L
- 77 Rock H
- 78 Rock M
- 79 Rock L
- 80 Vintg50s H
- 81 Vintg50s M
- 82 Vintg50s L
- 83 Vintg70s H
- 84 Vintg70s M
- 85 Vintg70s L
- 86 Metal H
- 87 Metal M
- 88 Metal L
- 89 BirchC H
- 90 BirchC M
- 91 BirchC L
- 92 Jazz H
- 93 Jazz M
- 94 Jazz L
- 95 Gate H
- 96 Gate M
- 97 Gate L
- 98 Electro H
- 99 Electro M
- 100 Electro L
- 101 T8-1 H
- 102 T8-1 M
- 103 T8-1 L
- 104 T8-2 H
- 105 T8-2 M
- 106 T8-2 L
- 107 T9-1 H
- 108 T9-1 M
- 109 T9-1 L
- 110 Syn H
- 111 Syn M
- 112 Syn L

### Cymbal

- 113 DarkRd20-1
- 114 DarkRd20-2
- 115 VtgRd 22
- 116 WarmRd 20
- 117 JazzRd 22
- 118 SzRide 20
- 119 Brilliant16
- 120 Brilliant18
- 121 Vivid 17
- 122 Bright 18
- 123 Dark 18
- 124 Vintage 16
- 125 Vintage 18
- 126 Jazz 18
- 127 SzCrash 20
- 128 Splash 1
- 129 Splash 2
- 130 China
- 131 Trash
- 132 ElecRide 1
- 133 ElecRide 2
- 134 ElecRide 3
- 135 ElecShaker
- 136 T8 Ride
- 137 T9 Ride
- 138 ElecCym 1
- 139 ElecCym 2
- 140 ElecCym 3
- 141 ElecCym 4
- 142 T8 Crash
- 143 T9 Crash
- 144 SynCrash 1
- 145 SynCrash 2
- 146 HipHopCr 1
- 147 HipHopCr 2
- 148 HipHopCr 3
- 149 HipHopCr 4
- 150 HipHopCr 5
- 151 RevCym 1
- 152 RevCym 2



**Hi-Hat**

153 Brilliant14  
 154 Dark 14  
 155 Vintage 14  
 156 Bright 14  
 157 Jazz 14  
 158 R&B 1  
 159 R&B 2  
 160 Electro 1  
 161 Electro 2  
 162 Electro 3  
 163 Electro 4  
 164 T8  
 165 T9  
 166 HipHop 1  
 167 HipHop 2  
 168 DNB

**Percussion**

169 Cajon Mt  
 170 Cajon Slp  
 171 Cajon Lo  
 172 Cajon Ft  
 173 PndeiroTap  
 174 PndeiroOp  
 175 PndeiroShk  
 176 PndeiroSld  
 177 Claves  
 178 Conga H Sw  
 179 Conga L Sw  
 180 BongoH Sw  
 181 BongoL Sw  
 182 Cowbell1Sw  
 183 Cowbell 2  
 184 Cowbell 3  
 185 Shaker Op  
 186 Shaker Cl  
 187 Timbales H  
 188 Timbales L  
 189 Vibraslap  
 190 Surdo Sw  
 191 Tambarin 1  
 192 Tambarin 2  
 193 Maracas  
 194 TriangleOp  
 195 TriangleMt  
 196 GuiroShort  
 197 GuiroLong  
 198 Agogo H  
 199 Agogo L  
 200 WoodBlockH  
 201 WoodBlockL  
 202 Caxixi Hit  
 203 Whistle S  
 204 Whistle L  
 205 Djambe Lo  
 206 Djambe Op  
 207 Djambe Slp  
 208 Djambe Mt  
 209 TalkDr Op  
 210 PotDrum Op  
 211 Dundun Op  
 212 Dundun Cl  
 213 Darbuka Op  
 214 Darbuka Sl  
 215 Darbuka Mt  
 216 Sangban Op  
 217 Kenkeni Op  
 218 AfricanBIH  
 219 AfricanBIL  
 220 Tombak Op  
 221 Daf Open  
 222 Daf Slap  
 223 Daf Mute  
 224 Riq Open  
 225 Riq Slap  
 226 Riq Shake  
 227 Riq Hit  
 228 Sagat Op  
 229 Sagat Cl  
 230 Sagat Sw  
 231 Tabla Na  
 232 Bayan Ge  
 233 Dhol RH Op  
 234 Dhol RH Cl  
 235 Dhol LH Op  
 236 Dhol LH Cl  
 237 KanjiraHit  
 238 KanjiraSlp  
 239 KanjiraShk  
 240 ZangGu  
 241 ZangGu Rim  
 242 BianGu  
 243 BianGu Rim  
 244 BianGuHand  
 245 TangGu  
 246 TangGu Rim  
 247 PaiGu 1  
 248 PaiGu 2  
 249 PaiGu 3  
 250 XiaoBo Opn  
 251 XiaoBo Cls  
 252 DaBo Opn  
 253 DaBo Cls  
 254 XiaoLuo  
 255 ZhongLuo  
 256 FengLuo  
 257 ShangNao 1  
 258 ShangNao 2  
 259 Qing H  
 260 Qing L  
 261 Taiko Don  
 262 Taiko Ka  
 263 KoTaik1Ten  
 264 KoTaik1Tsu  
 265 KoTaik2Ten  
 266 KoTaik2Tsu  
 267 TsuzumiPon  
 268 TsuzumiBnd  
 269 OokawaChon  
 270 Temple Blk  
 271 KontikiKon  
 272 Kontiki Ki

273 Atari Kon  
 274 Atari Chi  
 275 Ainote 1  
 276 Ainote 2  
 277 GranCasaOp  
 278 Castanet  
 279 SleighBel  
 280 WindChime  
 281 HandCym Op  
 282 HandCym Mt  
 283 FingerCymOp  
 284 RibonCrash  
 285 Timpani  
 286 Tamtam  
 287 Latin HH

# Specifications

## ■ Drum module

<b>Tone generator</b>	Type	AWM2
	Maximum polyphony	64 notes
	Voices	Drum and percussion: 287 Keyboard: 128
	Drum kits	10 (all of which may be edited and overwritten)
	Songs	10
	Reverb	9 types
<b>Metronome</b>	Tempo	30 to 300 BPM (Tap Tempo and Voice Guidance functions)
	Beats	1/4 to 9/4
<b>Other</b>	Jacks and terminals	SNARE (mini stereo audio) TOM1 (mini mono audio) TOM2 (mini mono audio) TOM3 (mini mono audio) RIDE (mini mono audio) CRASH (mini stereo audio) HI-HAT (mini mono audio) HI-HAT CTL (mini stereo audio) KICK/PAD (mini stereo audio) USB TO HOST (type B) AUX IN (mini stereo audio) PHONES/OUTPUT (standard stereo audio) DC IN
	Power consumption	5 W
	AC adaptor	PA-130 (or an equivalent recommended by Yamaha)
	Dimensions and weight	269 (W) × 147 (D) × 39 (H) mm, 0.5 kg 10-9/16"(W) × 5-13/16" (D) × 1-9/16" (H), 1 lb 2 oz





\* The contents of this manual apply to the latest specifications as of the publishing date.

To obtain the latest manual, access the Yamaha website then download the manual file.

Since specifications, equipment or separately sold accessories may not be the same in every locale, please check with your Yamaha dealer.

## Index

## Symbols

[12V  ] connector.....	24
[  ] (metronome) button.....	23
[  ] button.....	23
[  ] (Standby/On) button.....	23
[AUX IN] jack.....	24
[DRUM ON/OFF] button.....	23
[HI-HAT CTL] jack.....	24
[KICK/PAD] jack.....	24
[PHONES/OUTPUT] jack.....	24
[TEMPO] buttons.....	23
[USB TO HOST] terminal.....	24, 58
[VOLUME] buttons.....	23

## A

AC adaptor.....	9, 10, 11, 21
Auto Power-Off.....	22

## B

Beats.....	42
Bottom Panel.....	24

## C

Cable bands.....	9, 10, 11, 20
CHANGE UP.....	37
Choke.....	25
Click.....	29
Close.....	25
Closed rim shots.....	25
Computer.....	58
Control Panel.....	23
Cord clip.....	21
Crash cymbal pad.....	9, 10, 11
Cross sticking.....	25
Crosstalk.....	49
Cymbal holders.....	9, 10, 11
Cymbal/hi-hat pads.....	9, 10, 11

## D

Delete Song.....	55
Difficulty Level.....	51
Double Bass Drum.....	44
Drum key.....	9, 10, 11
Drum module.....	9, 10, 11
DYNAMIC GATE.....	33

## F

Factory Reset.....	22, 56
FAST BLAST.....	39
Foot closed.....	25
FP6110A.....	10, 11

## G

Gain.....	50
-----------	----

## H

Head shots.....	25
Headphones.....	21
HH40 Hi-hat controller.....	9
HH65 Hi-hat controller ..	10, 11, 25, 57
Hi-hat holder.....	9, 10, 11
Hi-hat splash.....	25

## K

Kick Unit.....	57
Kit.....	26
KP65.....	10, 11, 57
KU100 Kick unit.....	9

## M

MEASURE BREAK.....	36
Menu Mode.....	23, 41
Metronome.....	29
MIDI Reference.....	58
MIDI Reference Manual.....	7
MIDI Settings.....	45
Mode switch.....	23
Music category list.....	62
Music Player.....	21
Mute.....	28

## N

Nine-channel snake cable.....	9, 10, 11
Number buttons.....	23

## O

Open.....	25
Open rim shots.....	25

## P

PART MUTE.....	38
Pattern.....	42
PCY95AT.....	57
Play Mode.....	23, 26

## R

RECORDER.....	40
Revert to Last Power On.....	56
RHYTHM GATE.....	32
Rim.....	25

## S

S wing bolt.....	11
Score.....	31
Sensitivity.....	26
Separately Sold Accessories.....	57
Snare Pad.....	25
Song.....	27
SONG PART GATE.....	34
SONG SCORE GATE.....	35
Speakers.....	21

## T

Tap tempo.....	30
Tempo.....	29
Toms.....	13
Top Panel.....	24
TP70S Snare pad.....	11, 25
Training Mode.....	23, 31
Trigger input jacks.....	24

## V

Voice guidance.....	29, 53
Voice list.....	62

## Y

Yamaha Steinberg USB Driver.....	58
----------------------------------	----

## Information for users on collection and disposal of old equipment:



This symbol on the products, packaging, and/or accompanying documents means that used electrical and electronic products should not be mixed with general household waste. For proper treatment, recovery and recycling of old products, please take them to applicable collection points, in accordance with your national legislation.

By disposing of these products correctly, you will help to save valuable resources and prevent any potential negative effects on human health and the environment which could otherwise arise from inappropriate waste handling.

For more information about collection and recycling of old products, please contact your local municipality, your waste disposal service or the point of sale where you purchased the items.

### **For business users in the European Union:**

If you wish to discard electrical and electronic equipment, please contact your dealer or supplier for further information.

### **Information on Disposal in other Countries outside the European Union:**

This symbol is only valid in the European Union. If you wish to discard these items, please contact your local authorities or dealer and ask for the correct method of disposal.

(weee\_eu\_en\_02)

# Important Notice: Guarantee Information for customers in European Economic Area (EEA) and Switzerland

<b>English</b>	<b>Important Notice: Guarantee Information for customers in EEA* and Switzerland</b> For detailed guarantee information about this Yamaha product, and Pan-EEA* and Switzerland warranty service, please either visit the website address below (Printable file is available at our website) or contact the Yamaha representative office for your country. * EEA: European Economic Area
<b>Deutsch</b>	<b>Wichtiger Hinweis: Garantie-Information für Kunden in der EWR* und der Schweiz</b> Für nähere Garantie-Information über dieses Produkt von Yamaha, sowie über den Pan-EWR* und Schweizer Garantieservice, besuchen Sie bitte entweder die folgende angegebene Internetadresse (eine druckfähige Version befindet sich auch auf unserer Webseite), oder wenden Sie sich an den für Ihr Land zuständigen Yamaha-Vertrieb. *EWR: Europäischer Wirtschaftsraum
<b>Français</b>	<b>Remarque importante: Informations de garantie pour les clients de l'EEE* et la Suisse</b> Pour des informations plus détaillées sur la garantie de ce produit Yamaha et sur le service de garantie applicable dans l'ensemble de l'EEE ainsi qu'en Suisse, consultez notre site Web à l'adresse ci-dessous (le fichier imprimable est disponible sur notre site Web) ou contactez directement l'Yamaha dans votre pays de résidence. * EEE : Espace Economique Européen
<b>Nederlands</b>	<b>Belangrijke informatie voor klanten in de EER* en Zwitserland</b> Voor gedetailleerde garantie-informatie over dit Yamaha-product en de garantie van de EER* en Zwitserland, gaat u naar de onderstaande website (u vindt een afdrukbare bestand op onze website) of neemt u contact op met de vertegenwoordiging van Yamaha in uw land. * EER: Europese Economische Ruimte
<b>Español</b>	<b>Aviso importante: información sobre la garantía para los clientes del EEE* y Suiza</b> Para una información detallada sobre este producto Yamaha y sobre el soporte de garantía en la zona EEE* y Suiza, visite la dirección web que se incluye más abajo (la versión del archivo para imprimir está disponible en nuestro sitio web) o póngase en contacto con el representante de Yamaha en su país. * EEE: Espacio Económico Europeo
<b>Italiano</b>	<b>Avviso importante: informazioni sulla garanzia per i clienti residenti nell'EEA* e in Svizzera</b> Per informazioni dettagliate sulla garanzia relativa a questo prodotto Yamaha e l'assistenza in garanzia nei paesi EEA* e in Svizzera, potete consultare il sito Web all'indirizzo riportato di seguito (è disponibile il file in formato stampabile) oppure contattate l'ufficio di rappresentanza locale della Yamaha. * EEA: Area Economica Europea
<b>Português</b>	<b>Aviso importante: informações sobre as garantias para clientes da AEE* e da Suíça</b> Para obter uma informação pormenorizada sobre este produto da Yamaha e sobre o serviço de garantia na AEE* e na Suíça, visite o site a seguir (o arquivo para impressão está disponível no nosso site) ou entre em contato com o escritório de representação da Yamaha no seu país. * AEE: Área Económica Europeia
<b>Ελληνικά</b>	<b>Σημαντική σημείωση: Πληροφορίες εγγύησης για τους πελάτες στον ΕΟΧ* και την Ελλάδα</b> Για λεπτομερείς πληροφορίες εγγύησης σχετικά με το παρόν προϊόν της Yamaha και την κάλυψη εγγύησης σε όλο το εύρος του ΕΟΧ και την Ελλάδα, επισκεφτείτε την παρακάτω ιστοσελίδα (εγκυρίσιμη μορφή είναι διαθέσιμη στην ιστοσελίδα μας) ή απευθυνθείτε στην αντιπροσωπεία της Yamaha στη χώρα σας. * ΕΟΧ: Ευρωπαϊκός Οικονομικός Χώρος
<b>Svenska</b>	<b>Viktigt: Garantierinformation för kunder i EES-området* och Schweiz</b> För detaljerad information om denna Yamaha-produkt och garantier i hela EES-området* och Schweiz kan du antingen besöka nedanstående webbadress (en utskriftsvänlig fil finns på webbplatsen) eller kontakta Yamahas officiella representant i ditt land. * EES: Europeiska Ekonomiska Samarbetsområdet
<b>Norsk</b>	<b>Viktig merknad: Garantierinformasjon for kunder i EØS* og Sveits</b> Detaljert informasjon om dette Yamaha-produktet og garantier for hele EØS-området* og Sveits kan fås enten ved å besøke nettstedene nedenfor (utskriftsversjon finnes på våre nettsider) eller kontakte Yamahas kontoret i landet der du bor. *EØS: Det europeiske økonomiske samarbeidsområdet
<b>Dansk</b>	<b>Vigtig oplysning: Garantiplysninger til kunder i EØO* og Schweiz</b> De kan finde detaljerede garantiplysninger om dette Yamaha-produkt og den fælles garantierisicovering for EØO* (og Schweiz) ved at besøge det websted, der er angivet nedenfor (der findes en fil, som kan udskrives, på vores websted), eller ved at kontakte Yamahas nationale repræsentationskontor i det land, hvor de bor. * EØO: Det Europæiske Økonomiske Område

<b>Suomi</b>	<b>Tärkeä ilmoitus: Takuutiedot Euroopan talousalueen (ETA)* ja Sveitsin asiakkaille</b> Tämän Yamaha-tuotteen sekä ETA-alueen ja Sveitsin takuuta koskevat yksityiskohtaiset tiedot saatte alla olevasta nettiosoitteesta. (Tulostettava tiedosto saatavissa sivustollamme.) Voitte myös ottaa yhteyttä paikalliseen Yamaha-edustajaan. *ETA: Euroopan talousalue
<b>Polski</b>	<b>Ważne: Warunki gwarancyjne obowiązujące w EOG* i Szwajcarii</b> Aby dowiedzieć się więcej na temat warunków gwarancyjnych tego produktu firmy Yamaha i serwisu gwarancyjnego w całym EOG* i Szwajcarii, należy odwiedzić wskazaną poniżej stronę internetową (plik gotowy do wydruku znajduje się na naszej stronie internetowej) lub skontaktować się z przedstawicielstwem firmy Yamaha w swoim kraju. * EOG — Europejski Obszar Gospodarczy
<b>Česky</b>	<b>Důležité oznámení: Zásady informací pro zákazníky v EHS* a ve Švýcarsku</b> Podrobné zprávy o informacích o tomto produktu Yamaha a záručním servisu v celém EHS* a ve Švýcarsku naleznete na níže uvedené webové adrese (soubor k tisku je dostupný na našich webových stránkách) nebo se můžete obrátit na zastoupení firmy Yamaha ve své zemi. * EHS: Evropský hospodářský prostor
<b>Magyar</b>	<b>Fontos figyelmeztetés: Garancia-információk az EGT* területén és Svájcban élő vásárlók számára</b> A jelen Yamaha termék részletes garancia-információk, valamint az EGT*-re és Svájcra kiterjedő garanciális szolgáltatás tekintetében keressék fel webhelyünket az alábbi címen (a webhelyen nyomtatható fájl is található), vagy pedig lépjen kapcsolatba az országában működő Yamaha képviselői rovással. * EGT: Európai Gazdasági Térség
<b>Eesti keel</b>	<b>Ouline märkus: Garantiteave Euroopa Majanduspiirkonna (EMP)* ja Šveitsi klientidele</b> Täpsemat teabe saamiseks selle Yamaha toote garantii ning kogu Euroopa Majanduspiirkonna ja Šveitsi garantiteeninduse kohta, külastage palun veebisaiti alljärgneval aadressil (meie saidil on saadaval printitav fail) või pöörduge Teie riigioni Yamaha esinduse poole. * EMP: Euroopa Majanduspiirkond
<b>Latviešu</b>	<b>Svarīgs paziņojums: garantijas informācija klientiem EEZ* un Šveicē</b> Lai saņemtu detalizētu garantijas informāciju par šo Yamaha produktu, kā arī garantijas apkalpošanu EEZ* un Šveicē, lūdzam apmeklēt zemāk norādīto tīmekļa vietnes adresi (tīmekļa vieta ir pieejams drukājams fails) vai sazināties ar Jūsu valstī apkalpojamo Yamaha pārstāvniecību. * EEZ: Eiropas Ekonomikas zona
<b>Lietuvių kalba</b>	<b>Dėmesio: informacija dėl garantijos pirkėjams EEE* ir Šveicarijoje</b> Jei reikia išsamios informacijos apie šį „Yamaha“ produktą ir jo techninę priežiūrą visoje EEE* ir Šveicarijoje, apsilankykite mūsų svetainėje toliau nurodytu adresu (svetainėje yra spausdinamas failas) arba kreipkitės į „Yamaha“ atstovybę savo šaliai. *EEE – Europos ekonominė erdvė
<b>Slovenčina</b>	<b>Dôležité upozornenie: Informácie o záruke pre zákazníkov v EHP* a Švajčiarsku</b> Podrobnejšie informácie o záruke týkajúcej sa tohto produktu od spoločnosti Yamaha a garancijnom servise v EHP* a Švajčiarsku nájdete na webovej stránke uvedenej nižšie (na našej webovej stránke je k dispozícii súbor na tlač) alebo sa obráťte na zástupcu spoločnosti Yamaha vo svojej krajine. * EHP: Európsky hospodársky priestor
<b>Slovensščina</b>	<b>Pomembno obvestilo: Informacije o garanciji za kupce v EGP* in Švici</b> Za podrobnejše informacije o tem Yamahinem izdelku ter garancijskem servisu v celotnem EGP in Švici, obiščite spletno mesto, ki je navedeno spodaj (našljiva datoteka je na voljo na našem spletnem mestu), ali se obrnite na Yamahinega predstavnik v svoji državi. * EGP: Evropski gospodarski prostor
<b>Български език</b>	<b>Важно съобщение: Информация за гаранцията за клиенти в ЕИП* и Швейцария</b> За подробна информация за гаранцията за този продукт на Yamaha и гаранционното обслужване в паневропейската зона на ЕИП* и Швейцария или посетете посочения по-долу уеб сайт (на нашия уеб сайт има файл за печат), или се свържете с представителния офис на Yamaha във вашата страна. * ЕИП: Европейско икономическо пространство
<b>Limba română</b>	<b>Notificarea importantă: Informații despre garanție pentru clienții din SEE* și Elveția</b> Pentru informații detaliate privind acest produs Yamaha și serviciul de garanție Pan-SEE* și Elveția, vizitați site-ul la adresa de mai jos (fișierul imprimabil este disponibil pe site-ul nostru) sau contactați biroul reprezentanții Yamaha din țara dumneavoastră. * SEE: Spațiul Economic European

<http://europe.yamaha.com/warranty/>



## LIMITED WARRANTY ON YAMAHA DRUMS, HARDWARE AND ACCESSORY PRODUCTS

Thank you for selecting a YAMAHA product. YAMAHA products are designed and manufactured to provide a high level of defect-free performance. Yamaha Corporation of America ("YAMAHA") is proud of the experience and craftsmanship that goes into each and every YAMAHA product. YAMAHA sells its products through a network of reputable, specially authorized dealers and is pleased to offer you, the Original Owner, the following Limited Warranty, which applies only to products that have been (1) directly purchased from YAMAHA's authorized dealers in the fifty states of the USA and District of Columbia (the "Warranted Area") and (2) used exclusively in the Warranted Area. YAMAHA suggests that you read the Limited Warranty thoroughly, and invites you to contact your authorized YAMAHA dealer or YAMAHA Customer Service if you have any questions.

### THIS WARRANTY COVERS THE LISTED PRODUCTS AGAINST DEFECTS IN MATERIALS OR WORKMANSHIP.

Warranty Term

*Duration of Warranty from Date of Purchase by or for the Original Owner*

*Type of Product*

**Acoustic Drum Shells, Finish, Drum Hardware, Freestanding Hardware, Pedals, Hardware Accessories**  
**Electronic Drums Modules, Pads, Accessories, Hardware, Pedals**

**5 Years**  
**1 Year**

**Coverage:** YAMAHA will, at its option, repair or replace the product covered by this warranty if it becomes defective, malfunctions or otherwise fails to conform with this warranty under normal use and service during the term of this warranty, without charge for labor or materials. Repairs may be performed using new or refurbished parts that meet or exceed YAMAHA specifications for new parts. If YAMAHA elects to replace the product, the replacement may be a reconditioned unit. You will be responsible for any installation or removal charges and for any initial shipping charges if the product(s) must be shipped for warranty service. However, YAMAHA will pay the return shipping charges to any destination within the USA if the repairs are covered by the warranty. This warranty does not cover (a) damage, deterioration or malfunction resulting from accident, negligence, misuse, abuse, improper installation or operation or failure to follow instructions according to the Owner's Manual for this product; any shipment of the product (claims must be presented to the carrier); repair or attempted repair by anyone other than YAMAHA or an authorized YAMAHA Service Center; (b) any unit which has been altered or on which the serial number has been defaced, modified or removed; (c) normal wear and any periodic maintenance; (d) deterioration due to perspiration, corrosive atmosphere or other external causes such as extremes in temperature or humidity; (e) damages attributable to power line surge or related electrical abnormalities, lightning damage or acts of God; or (f) RFI/EMI (Interference/noise) caused by improper grounding or the improper use of either certified or uncertified equipment, if applicable. Any evidence of alteration, erasing or forgery of proof-of-purchase documents will cause this warranty to be void. This warranty covers only the Original Owner and is not transferable.

**In Order to Obtain Warranty Service:** Warranty service will only be provided for defective products within the Warranted Area. Contact your local authorized YAMAHA dealer who will advise you of the procedures to be followed. If this is not successful, contact YAMAHA at the address, telephone number or website shown below. YAMAHA may request that you send the defective product to a local authorized YAMAHA Servicer or authorize return of the defective product to YAMAHA for repair. If you are uncertain as to whether a dealer has been authorized by YAMAHA, please contact YAMAHA's Service Department at the number shown below, or check Yamaha's website at <http://usa.yamaha.com>. Product(s) shipped for service should be packed securely and must be accompanied by a detailed explanation of the problem(s) requiring service, together with the original or a machine reproduction of the bill of sale or other dated, proof-of-purchase document describing the product, as evidence of warranty coverage. Should any product submitted for warranty service be found ineligible therefore, an estimate of repair cost will be furnished and the repair will be accomplished only if requested by you and upon receipt of payment or acceptable arrangement for payment.

**Limitation of Implied Warranties and Exclusion of Damages:** ANY IMPLIED WARRANTIES, INCLUDING WARRANTIES OF MERCHANTABILITY AND FITNESS FOR A PARTICULAR PURPOSE SHALL BE LIMITED IN DURATION TO THE APPLICABLE PERIOD OF TIME SET FORTH ABOVE. YAMAHA SHALL NOT BE RESPONSIBLE FOR INCIDENTAL OR CONSEQUENTIAL DAMAGES OR FOR DAMAGES BASED UPON INCONVENIENCE, LOSS OF USE, DAMAGE TO ANY OTHER EQUIPMENT OR OTHER ITEMS AT THE SITE OF USE OR INTERRUPTION OF PERFORMANCES OR ANY CONSEQUENCES. YAMAHA'S LIABILITY FOR ANY DEFECTIVE PRODUCT IS LIMITED TO REPAIR OR REPLACEMENT OF THE PRODUCT, AT YAMAHA'S OPTION. SOME STATES DO NOT ALLOW LIMITATIONS ON HOW LONG AN IMPLIED WARRANTY LASTS OR THE EXCLUSION OR LIMITATION OF INCIDENTAL OR CONSEQUENTIAL DAMAGES, SO THE ABOVE LIMITATION OR EXCLUSION MAY NOT APPLY TO YOU. This Warranty gives you specific legal rights, and you may also have other rights which vary from state to state. This is the only express warranty applicable to the product specified herein; Yamaha neither assumes nor authorizes anyone to assume for it any other express warranty.

If you have any questions about service received or if you need assistance in locating an authorized YAMAHA Servicer, please contact:



CUSTOMER SERVICE

Yamaha Corporation of America

6600 Orangethorpe Avenue, Buena Park, California 90620-1373

Telephone: 800-854-1569 • <http://usa.yamaha.com>

**Do not return any product to the above address without a written Return Authorization issued by YAMAHA.**



Yamaha web site  
<https://www.yamaha.com/>  
Yamaha Downloads  
<https://download.yamaha.com/>

Manual Development Group  
©2018 Yamaha Corporation  
Published 04/2018 POMA\*.\*-\*\*A0

ZZ03340