

Technical Data

Speaker Type: 2-way battery speaker with wireless microphone (handheld or bodypack versions)

Acoustical data

Frequency Response [-10 dB]: 62 - 20000 Hz

Frequency Response [-6 dB]: 66 - 18100 Hz

Max SPL (1 m): 123 dB

HF compression driver: 1" Exit (voice coil: 1")

LF: 10" (voice coil: 1.5")

Crossover frequency: 2400 Hz

Dispersion: 90° (H) x 45° (V)

Amplifier

Amp Technology: Amp SMPS Power Supply

Amp Class: Class-D

RMS Power: 95 W

Peak Power: 190 W

Cooling: Passive (convection)

Operating voltage range:

220-240V~/100-120V~ 50-60 Hz (factory set)

Operating temperature: [-10 +55] °C

Charger operating temperature: [-0 +44] °C

B-HYPE MOBILE battery

Battery type: Li-Ion (25.9 V / 2200 mAh)

Charging time: Less than 2 hours

Mean usage time: 4 hours



POWER SUPPLY SPECIFICATIONS (POWER ABSORPTION)

Draw at 1/8 of full power in average use conditions (*): 0.35 A (220-240V~) - 0.57 A (100-120V~)

Draw at 1/3 of full power in maximum use conditions (**): 0.65 A (220-240V~) - 1.3 A (100-120V~)

Power absorption with speaker turned on without signal (idle): 16 W

* INSTALLER NOTES: The values refer to 1/8 of full power, in average operating conditions (music program with infrequent or no clipping). It is recommended to consider them the minimum sizing values for any type of configuration.

** INSTALLER NOTES: The values refer to 1/3 of full power, in heavy operating conditions (music program with frequent clipping or activation of the limiter).

Download the complete user manual on: www.dbtechnologies.com/EN/Downloads.aspx, or scan with your QR Reader App to download it.

EMI CLASSIFICATION

According to the standards EN 55103 this equipment is designed and suitable to operate in CLASS B Electromagnetic environments.

FCC CLASS B STATEMENT ACCORDING TO TITLE 47, PART 15, SUBPART B, §15.105

This equipment has been tested and found to comply with the limits for a Class B digital device, pursuant to part 15 of the FCC Rules.

These limits are designed to provide reasonable protection against harmful interference in a residential installation.

This equipment generates, uses and can radiate radio frequency energy and, if not installed and used in accordance with the instructions, may cause harmful interference to radio communications.

However, there is no guarantee that interference will not occur in a particular installation. If this equipment does cause harmful interference to radio or television reception, which can be determined by turning the equipment off and on, the user is encouraged to try to correct the interference by one or more of the following measures:

1. Reorient or relocate the receiving antenna.
2. Increase the separation between the equipment and receiver.
3. Connect the equipment into an outlet on a circuit different from that to which the receiver is connected.
4. Consult the dealer or an experienced radio/TV technician for help.

Changes or modifications not expressly approved by the party responsible for compliance could void the user's authority to operate the equipment.

B-HYPE MOBILE contains transmitter module:

HANDHELD VERSION → FCC ID: 2ADDV-HTBHM (USA) IC: 12207A-HTBHM (CANADA)

BODYPACK VERSION → FCC ID: 2ADDV-BTBHM (USA) IC: 12207A-BTBHM (CANADA)

WARNING: Make sure that the loudspeaker is securely installed in a stable position to avoid any injuries or damages to persons or properties. For safety reasons do not place one loudspeaker on top of another without proper fastening systems. Before hanging the loudspeaker check all the components for damages, deformations, missing or damaged parts that may compromise safety during installation. If you use the loudspeakers outdoor avoid spots exposed to bad weather conditions.

Contact dB Technologies for accessories to be used with speakers. dBTechnologies will not accept any responsibility for damages caused by inappropriate accessories or additional devices.

Features, specification and appearance of products are subject to change without notice. dBTechnologies reserves the right to make changes or improvements in design or manufacturing without assuming any obligation to change or improve products previously manufactured.

The Bluetooth® word mark and logos are registered trademarks owned by Bluetooth®SIG, Inc. and any use of such marks by AEB Industriale SRL is under license. Other Trademarks and trade names are those of their respective owners.

Integrated transmitter Charger

Rechargeable Device: HT-BHM handheld only (Ni-MH rechargeable batteries only)

Audio Media Player

Supported audio formats: .mp3, .wav, .wma

RF section

Available bands: 542-566 / 638-662 / 863-865 MHz

(factory set)

RF selectable channels: 8

Transmission range: up to 35 m (114.82 in)

Input / Output

Mains connections: VDE

Signal I/O: (Balanced) 1x combo (XLR/TRS) IN, 1x stereo

RCA IN, 1x mini-jack IN, 1 x TRS link OUT

Mixer controls: Volume controls, EQ, CH1/RF priority

Mechanics

Housing: Plastic cabinet

Grille: Full grille

Handles: 1 for each side, 1 on top (retractable)

Mounting pole: yes, 36 mm

Width: 300 mm (11.81 in)

Height: 568 mm (22.36 in)

Depth: 301 mm (11.86 in)

Weight (without transmitter): 12.5 kg (27 lbs.)

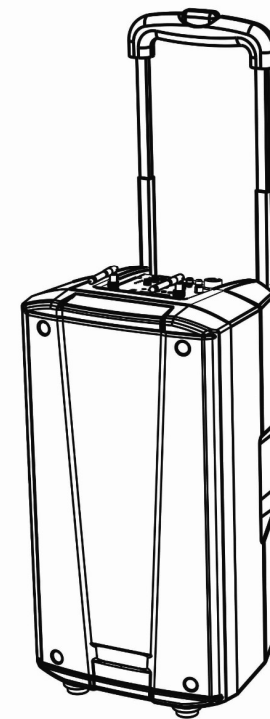

Handheld Transmitter Version / Bodypack Transmitter Version

Quick start user manual
Section 1

The warnings in this manual must be observed together with the "USER MANUAL - Section 2".

Le avvertenze nel presente manuale devono essere osservate congiuntamente al "MANUALE D'USO - Sezione 2".

Die Warnungen in diesem Handbuch müssen in Verbindung mit der "BEDIENUNGSANLEITUNG - Abschnitt 2" beobachtet werden".

Les avertissements spécifiés dans ce manuel doivent être respectés ainsi que les "CARACTERISTIQUES TECHNIQUES - Section 2".

Las advertencias del presente manual se deben tener en cuenta conjuntamente con las del "MANUAL DEL USUARIO" - Sección 2".

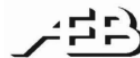

Thank you for choosing a dBTechnologies Product!

B-HYPE MOBILE is the new powerful bi-amped dBTechnologies battery speaker, available in two versions: handheld transmitter (**B-HYPE M HT bundle**) or bodypack transmitter (**B-HYPE M BT bundle**). It is equipped with: one 1" compression driver exit (1" voice coil) and one 10" woofer (1.5" voice coil). The input section allows the user to connect: up to three cabled inputs, one wireless microphone, and different media inputs (included a Bluetooth* one). The user can also connect the audio output to a second active speaker. The control section is equipped with a convenient equalizer and a CH1/RF priority function that mutes all the other channels, if the user is speaking. The long-lasting lithium battery allows an easy and portable usage for your music performances. Check the site www.dbtechnologies.com for the complete user manual!

1) UNPACKING

The box contains:

	B-HYPE MOBILE SPEAKER
	B-HYPE MOBILE ANTENNAS
	B-HYPE POWER CORD
	INCLUDED IN HANDHELD TRANSMITTER VERSION (B-HYPE M HT BUNDLE) ONLY*
	INCLUDED IN BODYPACK TRANSMITTER VERSION (B-HYPE M BT BUNDLE) ONLY*
	QUICKSTART AND WARRANTY DOCUMENTS
* SOLD ALSO AS SEPARATED ACCESSORIES	

NEVER USE THE HANDLES TO SUSPEND THE SPEAKER. THE USER MUST READ THE COMPLETE USER MANUAL AFTER THE FIRST SWITCH-ON AND FOR FURTHER INFORMATION.

2) BEFORE YOU START

a) Mount the antennas

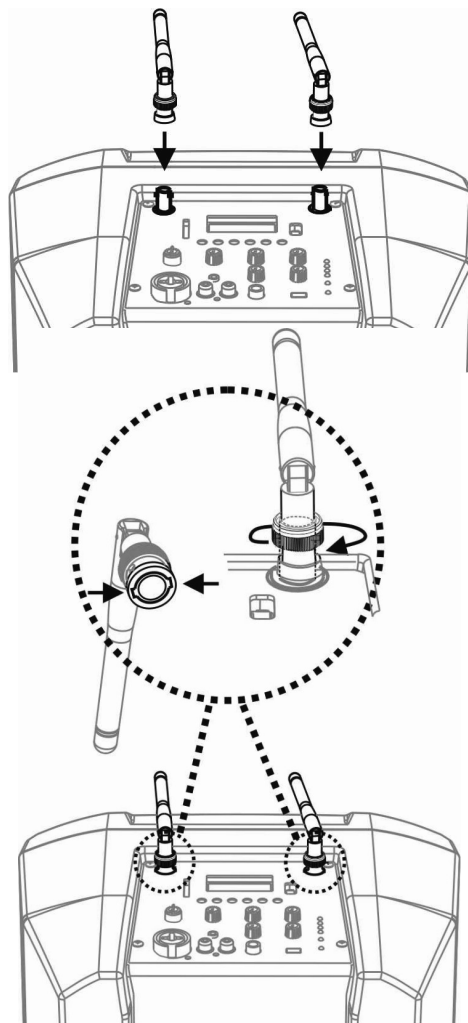

9) OPTIONAL ACCESSORIES AND RF BANDS

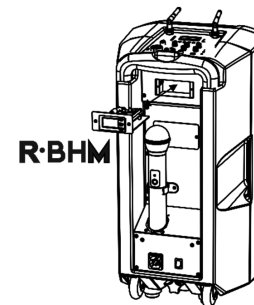

Depending on the voltage range, two or three RF bands are available to the user of B-HYPE MOBILE:

- 542-566 MHz (8 channels)
- 638-662 MHz (8 channels)
- 863-865 MHz (8 channels) *

*not available for 100-120V~

In order to change the wireless band the user must:

- Change the receiver **R-BHM**
- Change the transmitter (**HT-BHM** or **HM-BHM**)

See the complete manual for further details. In this page you can find the reference tables about main accessories and frequency bands.

Name	Type
R-BHM	RECEIVER MODULE*
BT-BHM	BODYPACK TRANSMITTER*
HT-BHM	HANDHELD TRANSMITTER*
HM-BHM	BLACK HEADSET
HM-BHM TAN	BEIGE HEADSET
* AVAILABLE FOR SPECIFIC RF BANDS USAGE	



Check periodically the website www.dbtechnologies.com for any documentation, and new accessories update.

Check the complete user manual on www.dbtechnologies.com for further information about the system and available accessories.

Scarica il manuale completo da www.dbtechnologies.com per ogni ulteriore informazione sul sistema e sugli accessori disponibili.

Für weitere Informationen und verfügbares Zubehör lesen sie bitte die vollständige Bedienungsanleitung unter www.dbtechnologies.com.

Vérifiez le manuel de l'utilisateur complet sur www.dbtechnologies.com pour des informations complémentaires du système et des accessoires disponibles. Compruebe el manual de usuario completo sobre www.dbtechnologies.com para la información adicional sobre el sistema y accesorios disponibles.

542 - 566 MHz	
Channel	Frequency
1	542.125 MHz
2	547.300 MHz
3	547.825 MHz
4	551.850 MHz
5	554.500 MHz
6	562.350 MHz
7	563.725 MHz
8	565.825 MHz

638 - 662 MHz	
Channel	Frequency
1	638.575 MHz
2	639.075 MHz
3	640.900 MHz
4	649.150 MHz
5	652.100 MHz
6	655.875 MHz
7	656.875 MHz
8	661.150 MHz

863 - 865 MHz*	
Channel	Frequency
1	863.025 MHz
2	863.175 MHz
3	863.475 MHz
4	863.625 MHz
5	864.375 MHz
6	864.525 MHz
7	864.825 MHz
8	864.975 MHz
* NOT AVAILABLE FOR 100-120V~ PRODUCTS	

7) MEDIA PLAYER SECTION

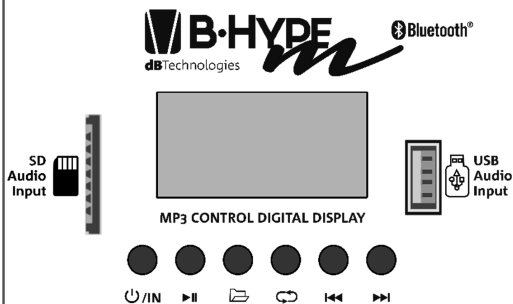

In this section you can find:

- SD Audio Input:
- USB Audio Input:
- Controls buttons

a) Audio reproduction from USB flash drive / SD CARD

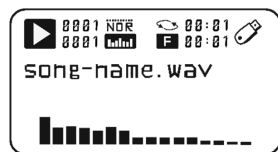

1. Turn on the B-HYPE MOBILE (see chapter 4 for further information), and check that the MASTER volume and the Bluetooth*/USB/SD one is on a medium/low level (see chapter 5).
2. Insert the correct device (a USB flash drive or SD CARD). Please note that only MP3, WAV and WMA files can be read and that the player can read only one media source at a time.
3. Push the **⏻/⏹** button for a few seconds. Once the reader is on, you can select the audio source by shortly pressing the same button.
4. Push the buttons **⏮** **⏪** **⏩** **⏭** to play/pause, search through the folders, repeat/change the equalization, rewind, fast forward a track respectively.
5. Adjust the MASTER and Bluetooth*/USB/SD volumes.

b) Audio reproduction from Bluetooth* device

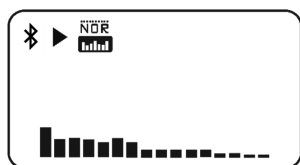

1. Turn on the B-HYPE MOBILE (see chapter 4 for further information), and check that the MASTER volume and the Bluetooth*/USB/SD one is on a medium/low level (see chapter 5).
2. Push the **⏻/⏹** button for a few seconds to turn on the player.
3. Once the reader is on, you can select the audio source by shortly pressing the same button.
4. Enable Bluetooth* transmission on your device and check that its “visibility mode” is enabled.
5. Once the communication is established, the name of your device is displayed on the screen. Adjust the source volume, and the MASTER and Bluetooth*/USB/SD ones.

8) THE HT-BHM CHARGER

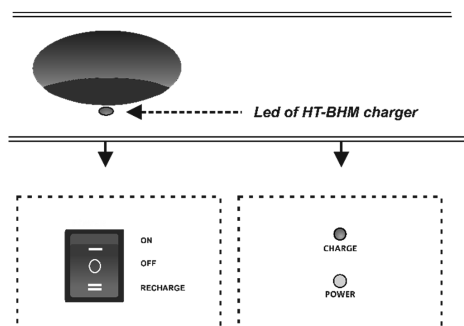

MAINS SECTION

CONNECTIONS AND CONTROL SECTION

“RECHARGE” mode allows the user to charge not only the internal Li-Ion battery, but also the HT-BHM transmitter. HT-BHM can be charged also in “ON” mode, while B-HYPE MOBILE is turned on. In order to correctly charge the transmitter:

1. Use the correct HT-BHM batteries (Ni-MH AA type only)
2. Insert properly the handheld transmitter in the charger on the rear panel
3. Turn on the B-HYPE MOBILE (“Power” LED green) or select the “RECHARGE” mode (“Charge” LED red).
4. The Led of HT-BHM charger can be:

- RED – the batteries are charging
- GREEN – the batteries are fully charged
- FLASHING RED – the batteries in the transmitter are not of the correct type

b) Place the batteries (not included)
Please note that for the correct use of the integrated charger of B-HYPE MOBILE, only Ni-MH batteries must be used with the HT-BHM.

HT·BHM

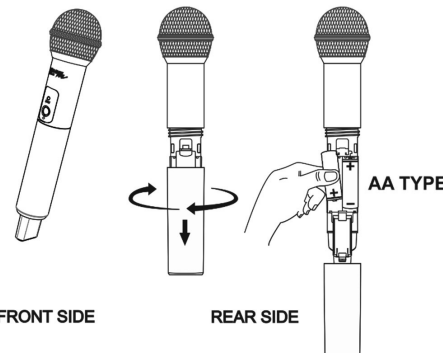

USE RECHARGEABLE NI-MH BATTERIES. DO NOT USE ALKALINE, LITHIUM, NiCd OR OTHER BATTERY CHEMISTRY.

BT·BHM

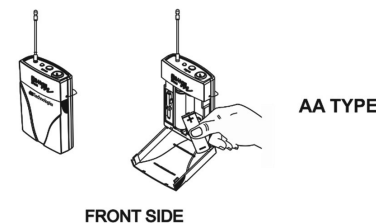

YOU CAN USE ANY TYPE OF AA BATTERIES

3) A CONTROLS OVERVIEW

The top and rear panel can be divided in main sections:

- MEDIA PLAYER SECTION
- CONNECTIONS AND CONTROL SECTION
- RECEIVER MODULE R-BHM
- BATTERY HOLDER
- HT-BHM CHARGER
- MAINS SECTION

In the following chapters these sections are presented and they are recalled with reference to this scheme.



MEDIA PLAYER SECTION

CONNECTIONS AND CONTROL SECTION

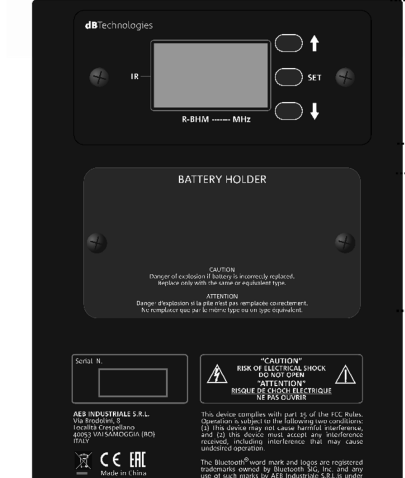

RECEIVER MODULE R-BHM

BATTERY HOLDER

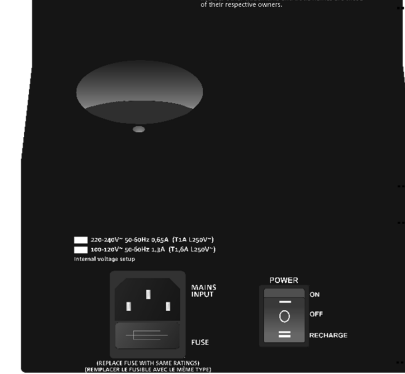

HT-BHM CHARGER

MAINS SECTION

4) MAINS SECTION

220-240V~ 50-60Hz 0,65A (T3A L250V~)
100-120V~ 50-60Hz 1,3A (T1,6A L250V~)
Internal voltage setup



(REPLACE FUSE WITH SAME RATINGS)
(REMPLACER LE FUSIBLE AVEC LE MEME TYPE)

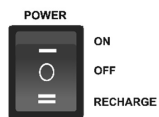

The mains section contains:

- Mains VDE connector
- Mains switch

The B-HYPE usage modes, once the VDE cable is connected are:

- ON (B-HYPE MOBILE is fully operative and it can operate with the battery without the mains cable, if charged, or with the mains cable inserted)
- OFF
- RECHARGE (the battery located in BATTERY HOLDER section charges with the power cord inserted, the B-HYPE MOBILE is turned off)

5) CONNECTIONS, CONTROLS, STATUS LEDs

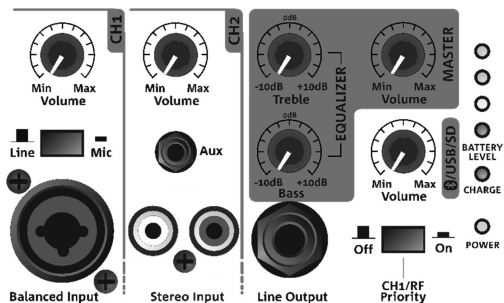

In this section you can find:

- CH1: Balanced/Unbalanced input (XLR/TLR combo connector type) with input sensitivity switch (LINE/MIC) and channel volume control.
- CH2: Aux input connector for 3,5 mm jack and RCA stereo input connectors with channel volume control.
- Master section with EQUALIZER rotaries (Treble and Bass separated regulations) and MAIN volume control.
- Bluetooth*/USB/SD volume control.
- Unbalanced Line Output. The signal which can be connected to another active loudspeaker is the output of the B-HYPE mobile mixer (so it is affected by all volume controls).
- CH1/RF Priority. If in "On" position the source audio level of CH2 and of Bluetooth*/USB/SD is instantly reduced by the presence of the CH1/RF signal).

- Control LEDs:
 1. POWER: green when B-HYPE MOBILE is on.
 2. CHARGE: red when B-HYPE MOBILE is in RECHARGE mode or in ON mode. It becomes green when the battery is fully charged.
 3. BATTERY LEVEL: four-stage LEDs that show the battery status.

At the first switch-on, in order to charge the lithium battery integrated in the B-HYPE MOBILE, simply plug the VDE mains cable and switch to "RECHARGE" till the CHARGE LED becomes green.

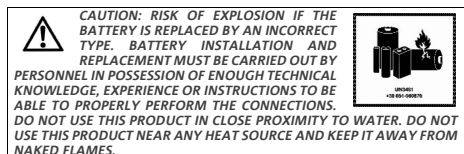

An example of connections in B-HYPE MOBILE is represented below, purely for information.

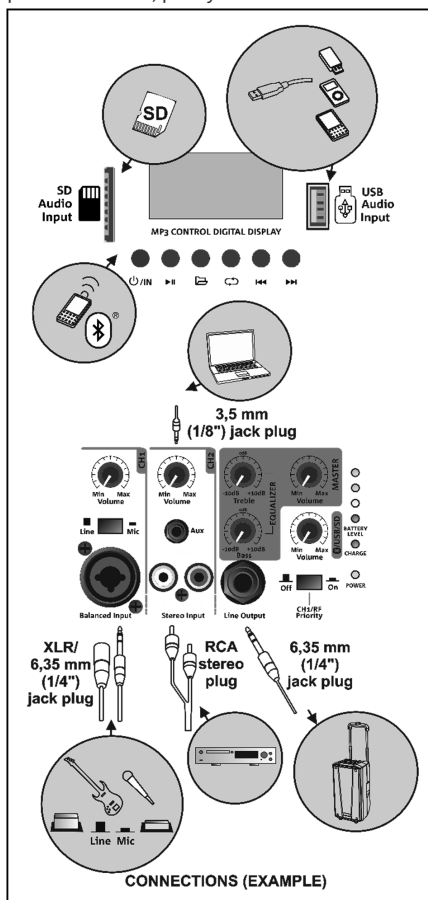

CONNECTIONS (EXAMPLE)

6) TURN ON AND SYNCHRONIZE THE TRANSMITTER TO THE RECEIVER

HT-BHM

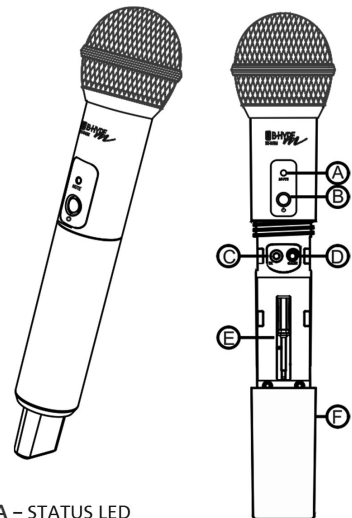

- A - STATUS LED
- B - POWER/MUTE SWITCH
- C - IR LENS
- D - GAIN (INPUT SENSITIVITY)
- E - PLASTIC SCREWDRIVER FOR [D] GAIN
- F - BATTERY COVER

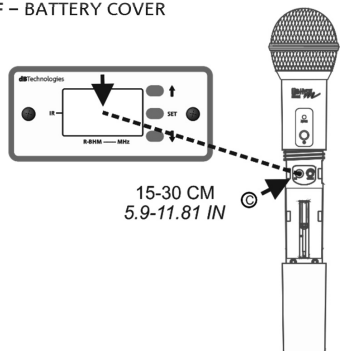

15-30 CM
5.9-11.81 IN

R-BHM

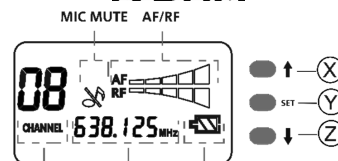

CHANNEL FREQUENCY BATTERY LEVEL
AF = AUDIO VOLUME INTENSITY
RF = WIRELESS RECEPTION INTENSITY

BT-BHM

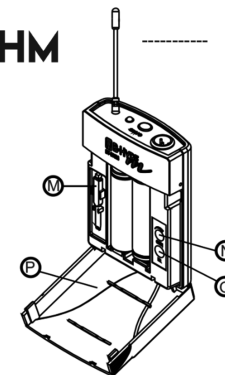
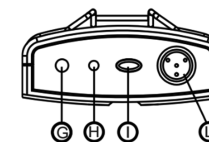

- G - ANTENNA
- H - STATUS LED
- I - POWER/MUTE SWITCH
- L - 4-POLE CONNECTOR FOR HEADSET
- M - PLASTIC SCREWDRIVER FOR [N] GAIN
- N - GAIN (INPUT SENSITIVITY)
- O - IR LENS
- P - BATTERY COVER

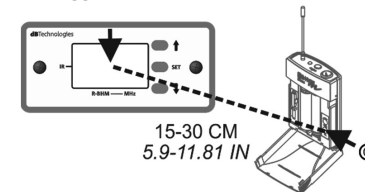

15-30 CM
5.9-11.81 IN

1. Turn on the B-HYPE MOBILE (see chapter 4 for further information), and check that the MASTER Volume is on a medium/low level (see chapter 5).
2. Unscrew the battery cover [F] of HT-BHM or open the [P] one of BT-BHM.
3. On the transmitter, hold down for a few seconds the "POWER" button [B], or [I] (for HT-BHM or BT-BHM). Please note that a short pressure enables "MUTE" status when the transmitter is on.
4. On the receiver, select one of the eight available channels by shortly pressing [X] or [Z] buttons.
5. Hold down for a few seconds the [X] button, then release it. The CHANNEL number in the display starts blinking.
6. The IR LENS of the transmitter must face the display of the RECEIVER MODULE R-BHM as shown in the pictures.
7. The transmitter is then synchronized with the receiver in a few seconds, and the CHANNEL number in the display becomes fixed.
8. RF indicator in the display shows the wireless reception intensity with a synchronized transmitter, the AF the audio volume one. You can enter the related submenus by pressing SET button. In the transmitter you can set the gain ([D] or [N]) with the related screwdriver [E] or [M].
9. Screw the battery cover [F] of HT-BHM or close the [P] one of BT-BHM.