



Büro für Tragwerksplanung und Ingenieurbau  
vom Felde + Keppler GmbH & Co. KG

Lütticher Straße 10-12  
52064 Aachen  
www.vom-felde.de

Telefon: 0241 / 70 96 96  
Telefax: 0241 / 70 96 46  
buero@vom-felde.de

## Kurzfassung der Statischen Berechnung Abstract of the Structural Report

**F23**

für das System der Firma  
for the system by

**Global Truss**  
Furong Industrial Area  
Shajing Town

Baoan District Shenzhen China

Aufgestellt:  
compiled by:

Aachen, 24.11.2014



Diese statische Berechnung umfasst die Seiten 1 - 19  
This Structural Report includes pages

Diese statische Berechnung ist ausschließlich aufgestellt für die Firma Global Truss.  
Eine Weitergabe an Dritte ist nur mit vorheriger Genehmigung des Aufstellers möglich.  
This Structural Report is set up exclusively for the company Global Truss.  
Forwarding to third parties only with the author's approval.



## INHALTSVERZEICHNIS

Table of contents

1	VORBEMERKUNGEN / PRELIMINARY NOTES .....	1
1.1	Grundlagen / Basics .....	1
1.2	Verwendete Baustoffe / Materials .....	1
1.3	Allgemeine Beschreibung / General remarks.....	1
1.4	Geometrie und Belastung / Geometry and loadings .....	3
2	SYSTEM.....	6
3	QUERSCHNITTS - UND MATERIALEIGENSCHAFTEN / SECTION- AND MATERIAL PROPERTIES .....	7
4	ZULÄSSIGE BELASTUNGEN EINZELBAUTEILE / ALLOWABLE LOADING SINGLE COMPONENTS ...	10
5	ZULÄSSIGE BELASTUNG EINFELDTRÄGER / ALLOWABLE LOADING SINGLE SPAN GIRDER .....	13
5.1	Gleichlast vertikal (UDL) / Vertically uniformly distributed loads (UDL) .....	13
5.2	Einzellast in Feldmitte / Single point load in 1/2 point .....	14
5.3	Einzellasten in den Drittelpunkten / Single point load in 1/3 points .....	15
5.4	Einzellasten in den Viertelpunkten / Single point load in 1/4 points .....	16
5.5	Einzellasten in den Fünftelpunkten / Single point load in 1/5 points .....	17
6	ZUSAMMENFASSUNG DER ERGEBNISSE / SUMMARY OF RESULTS.....	18
6.1	Zulässige Belastung / Allowable loading:.....	18
6.2	Vorhandene Durchbiegung unter max. Belastung / Deflection at allowable loading: .....	19
	<u>ANHÄNGE / ANNEXES</u> .....	

Zeichnungen Systeme F23. ....  
Drawings F23

F23050-Model, F23100-Model, F23150-Model, F23200-Model,  
F23250-Model, F23300-Model, F23350-Model, F23400-Model,  
F23450-Model, F23500-Model



# 1 VORBEMERKUNGEN

## PRELIMINARY NOTES

### 1.1 Grundlagen

#### Basics

Die z.Zt. gültigen Vorschriften und Normen, insbesondere:

DIN EN 1991-1	Lastannahmen für Bauten (Eurocode 1) Actions on structures (Eurocode 1)
DIN EN 13814	Fliegende Bauten Fairground and amusement park machinery and structures
DIN EN 13782	Fliegende Bauten – Zelte Temporary Structures – Tents
DIN EN 1993-1	Bemessung und Konstruktion von Stahlbauten (Eurocode 3) Design of steel structures
DIN EN 1999-1	Bemessung und Konstruktion von Aluminiumtragwerken (Eurocode 9) Design of aluminium structures

### 1.2 Verwendete Baustoffe

#### Materials

Rohre / Tubes	Aluminium EN AW-6061 T6 (Gurtrohre, chords)
Bolzen / Bolts	Aluminium EN AW-6061 T4 (Diagonalen, bracing) Güte min. 8.8 (grade min. 8.8)

### 1.3 Allgemeine Beschreibung

#### General Remarks

Diese statische Berechnung beinhaltet die Berechnung und die Nachweise eines Traversensystems, das von der Firma GLOBAL TRUSS hergestellt wird. Die Bezeichnung des Traversentyps lautet F23. Die Berechnung ist Grundlage für eine Bauartprüfung durch einen TÜV auf Grundlage der EN 1999-1.

Es handelt sich um ein „Baukastensystem“ mit den folgenden möglichen Einzelelementlängen: 500mm, 1000mm, 1500mm, 2000mm, 2500mm, 3000mm, 3500mm, 4000mm, 4500mm und 5000mm.

Die Traverse bestehen aus einem Ober- und zwei Untergurten (Rundrohre 35 x 1,6mm), in dreieckiger Anordnung und angeschweißten Diagonalstäben (Rundstäbe  $\varnothing$ 8mm). Die Diagonalstäbe werden in allen 3 Seiten angeordnet.

Der Achsabstand der Gurtrohre beträgt 18,5 cm.

Die Traversen werden über Kupplungen miteinander verbunden, die aus einer Hülse, einem Verbinder und Bolzen bestehen.

Die zulässigen Belastungen sind in Tabellen aufgeführt (siehe Kapitel 6).

Die Nachweise der Einzelbauteile erfolgen nach dem Sicherheitskonzept nach EN 1990 mit einem Teilsicherheitsbeiwert auf der Lastseite von  $\gamma_F = 1,50$  für Nutzlasten.

Bei Anwendungsfällen, die auf Grundlage anderer Normen berechnet werden, können die Teilsicherheitsbeiwerte auf der Lastseite angepasst werden (z.B. fliegende Bauten nach EN 13814,  $\gamma_F = 1,35$  für Nutzlasten).



Bei Anwendung des British Standard (BS) und des ANSI müssen die in den Tabellen aufgeführten zulässigen Belastungen mit dem Faktor 0,85 multipliziert werden.

This structural report is an structural calculation concerning a trussystem produced by the company GLOBAL TRUSS. The truss types go by the names F23. The structural report is the basis for the certification by TÜV based on EN 1999-1.

The truss system is part of a "modular construction system" with the different truss lengths

500mm, 1000mm, 1500mm, 2000mm, 2500mm, 3000mm, 3500mm, 4000mm, 4500mm and 5000mm.

The Trusses consist of one upper and two lower main chords (round tube 35 x 1,6mm), which are arranged in a triangular shape. The trusses also consist of welded diagonal bracings (roundbars  $\varnothing$  8mm). The truss type F23 is stiffened by diagonal bracings at all three sides.

The distance between system lines of the mainchords is 18,5 cm.

The trusses are connected with couplers consisting of female fittings, connectors and bolts.

The allowable loads are listed in tables (see chapter 6).

The verification of the single parts is done according the safety concept of EN 1990 with a partial safety factor of the loading side of 1.50 for payloads.

For applications which can be calculated on the basis of other codes, the partial safety factors can be adjusted (for example temporary structures acc. EN 13814,  $\gamma_F = 1.35$  for payloads).

To use the resulting allowable loads with British Standard (BS) and ANSI, the allowable loads listed in tables have to be multiplied by 0.85.



## 1.4 Geometrie und Belastung

### Geometry and Loadings

Als Belastung werden folgende Lastarten untersucht /  
the following loadcases are taken into account

Gleichlast vertikal  
uniformly distributed load (UDL)

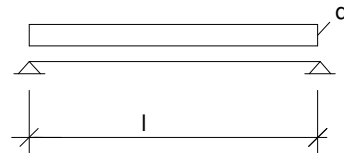

Einzellast in Feldmitte  
Single-load in 1/2 point

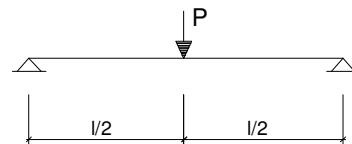

Einzellasten in den Drittelpunkten  
Single-load in 1/3 point

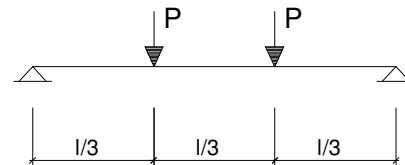

Einzellasten in den Viertelpunkten  
Single-load in 1/4 point

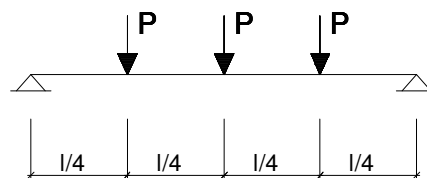

Einzellasten in den Fünftelsspunkten  
Single-load in 1/5 point

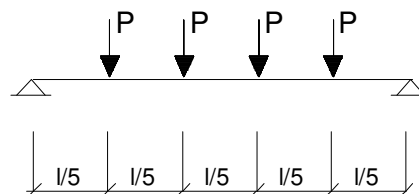

Das Eigengewicht der Traverse beträgt ca. 3,0 kg/m.  
The selfweight of the truss is approx. 3,0 kg/m



Für die Anwendung der hier ermittelten Belastungswerte gelten folgende Regeln:  
For the application of the calculated allowable loadings the following rules have to be regarded:

Die Einzellasten sind an den Knoten einzuleiten oder über geeignete zusätzliche Konstruktionen zu verteilen.  
Large loads have to be applied at the nodes or have to be distributed by appropriate constructions.

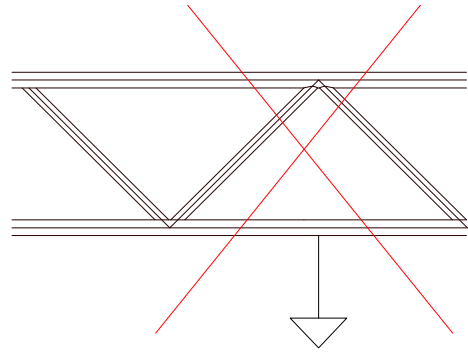
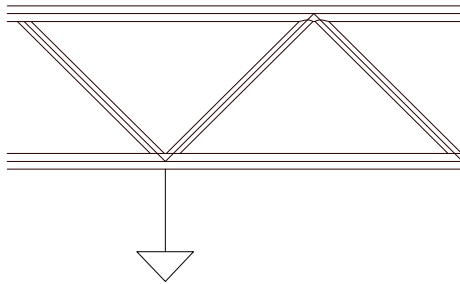

Die Lasten mittig auf den Kupplungen sind nicht zulässig.  
Loads at the middle of the couplers are not allowed.

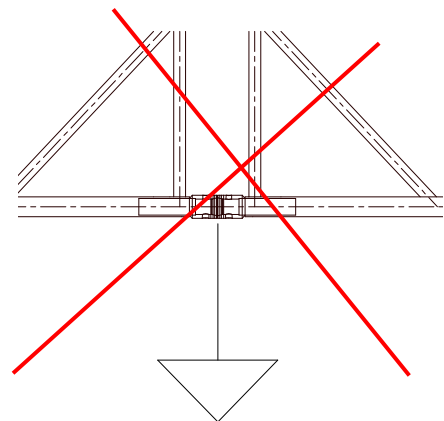
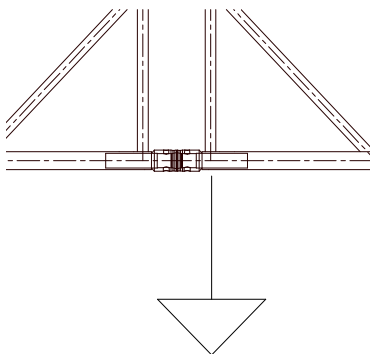

Alle Lasten sind gleichmäßig auf die Gurte zu verteilen.  
All loads have to be distributed equally to the chords.

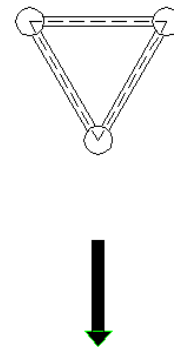
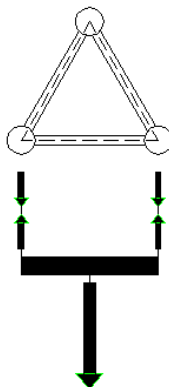
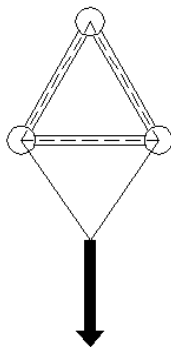



Für die Auflagerung bzw. Aufhängung des Systems bestehen folgende Möglichkeiten:  
For the support or suspension there are the following possibilities:

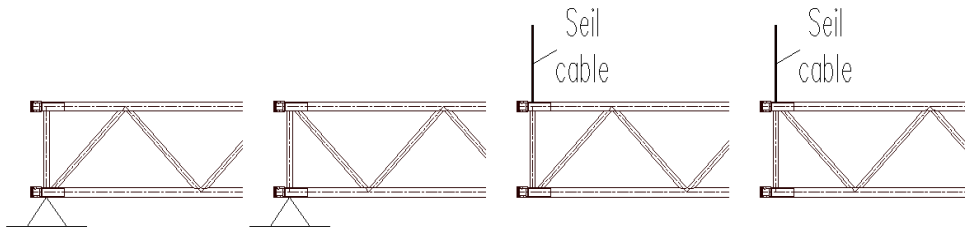



## 2 SYSTEM

Zeichnungen Systeme F23. ....  
Drawings F23

F23050-Model, F23100-Model, F23150-Model, F23200-Model,  
F23250-Model, F23300-Model, F23350-Model, F23400-Model,  
F23450-Model, F23500-Model

siehe Anhang  
see annex





### 3 QUERSCHNITTS - UND MATERIALEIGENSCHAFTEN

#### SECTION- AND MATERIAL PROPERTIES

Querschnittswerte Rohre / properties Tubes						
	D	t	A	I	Wel	i
	[mm]	[mm]	[cm <sup>2</sup> ]	[cm <sup>4</sup> ]	[cm <sup>3</sup> ]	[cm]
Gurtrohre / main chords	35,0	1,6	1,68	2,35	1,34	1,18
vertikal Diagonalen / Bracing	8	-	0,50	0,02	0,05	0,20
horizontal Diagonalen / Bracing	8	-	0,50	0,02	0,05	0,20

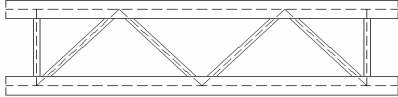
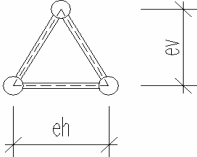
Geometrie Traverse / truss geometry				
				
Achsabstand Gurtrohre	vertikal	ev	16,03	[cm]
distance axes main chords	horizontal	eh	18,5	[cm]
min. Neigung Diagonalen	vertikal	$\alpha$	40,5	[°]
min. gradient bracing	horizontal	$\alpha$	40,5	[°]
Kennwerte Gesamttraverse / properties truss-Section				
A	=	$3 \times A_G$	=	6,72 [cm <sup>2</sup> ]
I <sub>yy</sub>	=	$3 \times I_G + A_G \times [2 \times (ev/3)^2 + (ev \times 2/3)^2]$	=	294,64 [cm <sup>4</sup> ]
I <sub>zz</sub>	=	$3 \times I_G + 2 \times A_G \times (eh/2)^2$	=	294,34 [cm <sup>4</sup> ]
I <sub>t</sub>	=	aus Näherung / approximately	=	40,00 [cm <sup>4</sup> ]
i <sub>y</sub>	=	$(I_{yy}/A)^{1/2}$	=	6,62 [cm]
i <sub>z</sub>	=	$(I_{zz}/A)^{1/2}$	=	6,62 [cm]
Index G :		Querschnittseigenschaft Gurtrohr section properties main chord		



**Materialeigenschaften**  
Material properties

<b>Gurtrohre</b>	<b>EN AW 6061 T6</b>
chords	
zulässige Spannungen nach EN-1999-1-1 / allowable stress acc. to EN-1999-1-1	
Teilsicherheitsbeiwerte Material / partial safety factors material	
YM1=	1,10
YM2=	1,25
	Beulklasse / BC= <b>A</b>
0,2%-Dehngrenze / 0,2%-Proof Strength	
fo t<25mm=	240 [N/mm <sup>2</sup> ]
fo,haz=	115 [N/mm <sup>2</sup> ]
Zugfestigkeit / ultimate tensile strength	
fu t<5mm=	260 [N/mm <sup>2</sup> ]
fu,haz=	175 [N/mm <sup>2</sup> ]
Festigkeit der Schweißnaht	
Strength of welding seams	fw= 170 [N/mm <sup>2</sup> ]
Faktor für die WEZ-Werte beim WIG-Schweißen:	
Factor for HAZ-values for TIG-welding:	0,8

<b>Diagonalen</b>	<b>EN AW 6061 T4</b>
bracing	
zulässige Spannungen nach EN-1999-1-1 / allowable stress acc. to EN-1999-1-1	
Teilsicherheitsbeiwerte Material / partial safety factors material	
YM1=	1,10
YM2=	1,25
	Beulklasse / BC= <b>B</b>
0,2%-Dehngrenze / 0,2%-Proof Strength	
fo t<25mm=	110 [N/mm <sup>2</sup> ]
fo,haz=	95 [N/mm <sup>2</sup> ]
Zugfestigkeit / ultimate tensile strength	
fu t<5mm=	180 [N/mm <sup>2</sup> ]
fu,haz=	150 [N/mm <sup>2</sup> ]
Festigkeit der Schweißnaht	
Strength of welding seams	fw= 170 [N/mm <sup>2</sup> ]
Faktor für die WEZ-Werte beim WIG-Schweißen:	
Factor for HAZ-values for TIG-welding:	0,8



<b>Bolzen / Bolt</b>	min. grade 8.8
----------------------	----------------

<b>Verbinder / Connector</b>	EN AW 2011 (AlCuBiPb F37)		
0,2%-Dehngrenze / 0,2%-Proof Strength	Zugfestigkeit / ultimate tensile strength		
fo>	230 [N/mm <sup>2</sup> ]	fu>	310 [N/mm <sup>2</sup> ]

<b>Hülse / Female fitting</b>	EN AW 6061 T6		
zulässige Spannungen nach EN-1999-1-1 / allowable stress acc. to EN-1999-1-1			
Teilsicherheitsbeiwerte Material / partial safety factors material			
YM1=	1,10		
YM2=	1,25		
0,2%-Dehngrenze / 0,2%-Proof Strength	Zugfestigkeit / ultimate tensile strength		
fo=	240 [N/mm <sup>2</sup> ]	fu=	260 [N/mm <sup>2</sup> ]

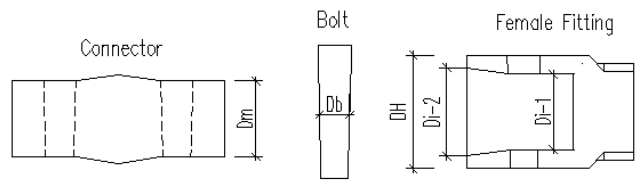



## 4 ZULÄSSIGE BELASTUNGEN EINZELBAUTEILE

### ALLOWABLE LOADING SINGLE COMPONENTS

In dieser Kurzfassung werden nur die maßgebenden zulässigen Beanspruchungen aufgeführt. Die Berechnung der zulässigen Beanspruchung aller Bauteile erfolgt in der Statischen Berechnung 14917 vom 01.09.2014.

In this abstract only the relevant allowable loadings are mentioned. The calculation of the allowable loadings of all parts is done in the Structural Report 14917 from 01.09.2014.

Maßgebend für die Ermittlung der zulässigen Belastungen sind folgende Punkte:  
Following points are relevant for the determination of the allowable loads:

1. Zulässige Normalkraft im Gurtrohr (NRd<sub>G</sub>)  
Allowable normal force in main chord

Gurtrohr im Bereich der WEZ an Kupplung maßgebend      =>      NRd<sub>G</sub> = 18,80 kN  
Main chord in heat affected zone at coupler is relevant

Gurtrohr im Bereich der WEZ an der Kupplung main chord in heat affected zone at coupler	
$NRd = A \times 0,8^* \times f_{u,haz} / Y_{M2} =$	<b>18,80</b> [kN]      *(WIG $\pi_{IG}$ ) örtliche Schweißnaht nach Kap. 6.2.9.3 (1) local welding seam acc. chapter 6.2.9.3 (1)

2. Globale Querkraft in der Traverse (Q)  
Global shear force in truss

Maßgebend Zul N-Kraft infolge Knicken      =>      NRd<sub>D</sub> = 1,72 kN  
Allowable normal force due to buckling

Knicken Diagonale buckling bracing	sk= <b>23,50</b> [cm]
$NRd = X \times A_G \times f_o / Y_{M1} =$	<b>1,72</b> [kN]      nach Gl. 6.49 acc. equation 6.49

zul Querkraft aus       $QRd / (2 \cdot \sin 40,5^\circ) < 0,9 \cdot NRd_D$

\* 10 % Abminderung wg. Einfluss aus Nebenspannungen  
(10% reduction because of minor stresses)

=> zul QRd =  $0,9 \cdot 1,72 \cdot 2 \cdot \sin 40,5^\circ \cdot \sin 60^\circ$       =>      QRd > 1,01 kN

3. Interaktion Querbiegung und Normalkraft an der Kupplung  
Interaction bending and normal force at coupler      siehe folgende Seiten  
see following pages



## Interaktion Biegung und Normalkraft an der Kupplung Interaction bending and normal force at coupler

Normalkraft und Biegemomente werden über die Schweißnaht zwischen Kupplung und Gurtrohr übertragen.

Normal force and bending moments are transmitted by the welding seam between coupler and chord.

Nachweis der Interaktion Biegung und Normalkraft an Kupplung

Verification of interaction bending and normal force at coupler

$$\Rightarrow \quad (\mathbf{Nsd}_G / \mathbf{NRd}_G)^{1,3} + (\mathbf{Msd}_G / \mathbf{MRd}_G) < 1,0$$

mit  $\mathbf{Nsd}_G = \mathbf{Nsd} / 3 + \mathbf{Msd} / (0,160 \text{ m})$   $n = 1$   $b = 0,160 \text{ m}$

und  $\mathbf{Msd}_G = 1,53 \text{ cm} \cdot \mathbf{Qsd}$

$\mathbf{Nsd}$ ,  $\mathbf{Msd}$  und  $\mathbf{Qsd}$ : globale Schnittgrößen in der Traverse (in kN bzw. kNm)  
global internal forces in the truss (in kN resp. kNm)

Die globalen Schnittgrößen sind Bemessungsschnittgrößen, die die folgenden Sicherheitsbeiwerte nach Eurocode enthalten:

The global internal forces include the following safety factors acc. Eurocode:

Eigengewicht der Traversen:  $yF = 1,35$

selfweight of the truss:

Nutzlasten auf der Traversen:  $yF = 1,50$

Net load on the truss:

$\mathbf{NRd}_G =$  zulässige Beanspruchung des Gurtrohrs in der WEZ (siehe folgende Tabelle):

= allowable loading of the chord in the heat affected zone (see following table):

Gurtrohr im Bereich der WEZ an der Kupplung main chord in heat affected zone at coupler			
$\mathbf{NRd} = A \times 0,8^* \times f_{u,haz} / \mathbf{YM2} =$	<b>18,80</b>	[kN]	*(WIG TIG) örtliche Schweißnaht nach Kap. 6.2.9.3 (1) local welding seam acc. chapter 6.2.9.3 (1)

$\mathbf{MRd}_G = \mathbf{MuRd}$  (siehe folgende Tabelle):

=  $\mathbf{MuRd}$  (see following table):

Lokale Biegung Gurtrohr Knotenpunkt vollst. in WEZ Local bending of chord			
$\mathbf{MuRd} = \mathbf{Wnet} \cdot f_u / \mathbf{yM2} =$	<b>15,70</b>	[kNcm]	nach Gl. 6.24 acc. equation 6.24



Es werden 2 Fälle betrachtet.  
The following 2 cases are taken into account.

### 1. Belastung bei gleichförmigen Streckenlasten

Loading with uniformly distributed load (UDL)

Hier wird immer eine Kupplung an der theoretisch ungünstigsten Stelle berücksichtigt.  
Diese ergibt sich aus einer Extremwertbetrachtung:  
The coupler is always located at the theoretically worst point. This results from an extremum-calculation:

$$x = 0,294 \text{ m (Abstand von Feldmitte / from middle of span)}$$

### 2. Belastung durch Einzellasten ohne Einschränkung hinsichtlich Position der Kupplung

Loading with **single-point loads** without requirements for position of couplers

Keine Anforderungen an Position der Kupplung (Abstand der Lasteinleitungsstelle zur Kupplung beträgt  $e$ , siehe unten).

No requirements for position of coupler (Distance between load and coupler is  $e$ , see below).

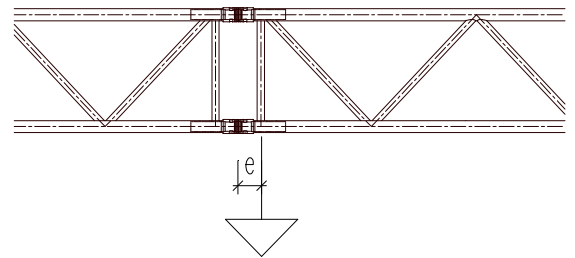



## 5 ZULÄSSIGE BELASTUNG EINFELDTRÄGER

### ALLOWABLE LOADING SINGLE SPAN GIRDER

#### 5.1 Gleichlast vertikal (UDL)

uniformly distributed load (UDL)

System:

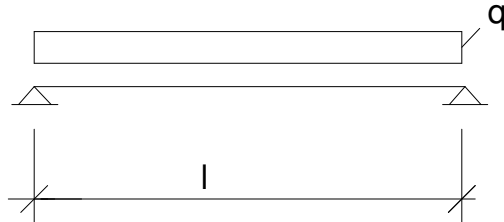

$$q_{sd} = p_{sd} + g_{sd}$$

Normalkraft im Gurt:  
Normal force chord

$$\Rightarrow \text{zul } p = (NR_d \cdot (n \cdot b) \cdot 8 / L^2 - g_{sd}) / \gamma_F$$

Normalkraft in der Diagonalen  
Normal force bracing

$$\Rightarrow \text{zul } p = (QR_d \cdot 2 / L - g_{sd}) / \gamma_F$$

Interaktion an der Kupplung:  
Interaction at coupler

$$\Rightarrow (N_{sdG} / NR_{dG})^{1,3} + (M_{sdG} / MR_{dG}) < 1,0$$

angesetzt: Abstand Kupplung von Feldmitte  $e = 0,294$  m (ungünstigste Stelle, Herleitung: siehe Extremwertbetrachtung in Kapitel 4)

applied: The coupler is located at  $e = 0,294$  m from the middle of the span (theoretically worst point, see extremum-calculation in chapter 4)

Belastungstabelle:  
Loading-table:

#### Gleichstreckenlast

Uniformly distributed load UDL

zulässige Belastung in Abhängigkeit von				
allowable load as a function of				
	Nrd	Qrd	Interaction at coupler	
L [m]	zul q [kN/m]	zul q [kN/m]	zul q [kN/m]	min zul q [kN/m]
2,00	3,99	0,65	3,79	0,65
3,00	1,76	0,42	1,72	0,42
4,00	0,98	0,31	0,97	0,31
5,00	0,62	0,24	0,61	0,24
6,00	0,42	0,20	0,42	0,20
7,00	0,30	0,17	0,30	0,17
8,00	0,22	0,14	0,22	0,14
9,00	0,17	0,12	0,17	0,12
10,00	0,13	0,11	0,13	0,11



## 5.2 Einzellast in Feldmitte:

Single-load in 1/2 point

System

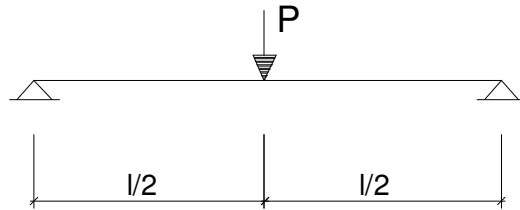

Normalkraft im Gurt:  
Normal force chord

$$\Rightarrow \text{zul } P = [\text{NRd} \cdot (n \cdot b) - \text{gsd} \cdot L^2 / 8] \cdot 4 / L / \gamma_F$$

Normalkraft in der Diagonalen  
Normal force bracing

$$\Rightarrow \text{zul } P = (\text{QRd} - \text{gsd} \cdot L / 2) \cdot 2 / \gamma_F$$

Interaktion an der Kupplung:  
Interaction at coupler

$$\Rightarrow (\text{Nsd}_G / \text{NRd}_G)^{1,3} + (\text{Msd}_G / \text{MRd}_G) < 1,0$$

angesetzt: Lasteinleitung an der Kupplung

$e = 0,05 \text{ m}$

applied: Loading point at coupler

$e = 0,05 \text{ m}$

Belastungstabellen:  
Loading-tables:

### Einzellast in Feldmitte

Single-load in 1/2point

zulässige Belastung in Abhängigkeit von				
allowable load as a function of				
	Nrd	Qrd	Interaction at coupler	
			0,05	= e [m]
L [m]	zul P [kN]	zul P [kN]	zul P [kN]	min zul P [kN]
2,00	3,99	1,29	3,23	1,29
3,00	2,64	1,27	2,28	1,27
4,00	1,96	1,24	1,76	1,24
5,00	1,54	1,21	1,43	1,21
6,00	1,26	1,18	1,19	1,18
7,00	1,05	1,16	1,00	1,00
8,00	0,90	1,13	0,86	0,86
9,00	0,77	1,10	0,74	0,74
10,00	0,67	1,08	0,65	0,65





### 5.3 Einzellasten in den Drittelpunkten:

Single-loads in 1/3 points

System

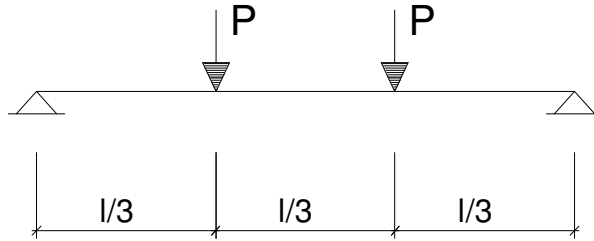

Normalkraft im Gurt:

Normal force chord

$$\Rightarrow \text{zul } P = [\text{NRd} \cdot (n \cdot b) - \text{gsd} \cdot L^2 / 8] \cdot 3 / L / \gamma_F$$

Normalkraft in der Diagonalen

Normal force bracing

$$\Rightarrow \text{zul } P = (\text{QRd} - \text{gsd} \cdot L / 2) / \gamma_F$$

Interaktion an der Kupplung:

Interaction at coupler

$$\Rightarrow (\text{Nsd}_G / \text{NRd}_G)^{1,3} + (\text{Msd}_G / \text{MRd}_G) < 1,0$$

angesetzt: Lasteinleitung an der Kupplung

$e = 0,05 \text{ m}$

applied: Loading point at coupler

$e = 0,05 \text{ m}$

Belastungstabellen:

Loading-tables:

#### Last in den Drittelpunkten

Single-load in 1/3points

zulässige Belastung in Abhängigkeit von				
allowable load as a function of				
	Nrd	Qrd	Interaction at coupler	
			0,05	= e [m]
L [m]	zul P [kN]	zul P [kN]	zul P [kN]	min zul P [kN]
2,00	2,99	0,65	2,24	0,65
3,00	1,98	0,63	1,61	0,63
4,00	1,47	0,62	1,25	0,62
5,00	1,15	0,61	1,02	0,61
6,00	0,94	0,59	0,86	0,59
7,00	0,79	0,58	0,73	0,58
8,00	0,67	0,57	0,63	0,57
9,00	0,58	0,55	0,55	0,55
10,00	0,50	0,54	0,48	0,48



### 5.4 Einzellasten in den Viertelpunkten:

Single-loads in 1/4 points

System

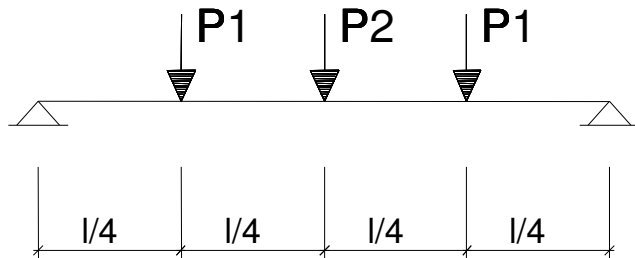

Normalkraft im Gurt:

Normal force chord

$$\Rightarrow \text{zul } P = [NRd \cdot (n \cdot b) - gsd \cdot L^2 / 8] \cdot 2 / L / yF$$

Normalkraft in der Diagonalen

Normal force bracing

$$\Rightarrow \text{zul } P = (QRd - gsd \cdot L / 2) \cdot 2 / 3 / yF$$

Interaktion an der Kupplung:

Interaction at coupler

$$\Rightarrow (Nsd_G / NRd_G)^{1,3} + (Msd_G / MRd_G) < 1,0$$

angesetzt: Lasteinleitung an der Kupplung

$e = 0,05 \text{ m}$

applied: Loading point at coupler

$e = 0,05 \text{ m}$

Belastungstabellen:

Loading-tables:

### Last in den Viertelpunkten

Single-load in 1/4points

zulässige Belastung in Abhängigkeit von					
allowable load as a function of					
	Nrd	Qrd	Interaction at coupler 1	Interaction at coupler 2	
			0,05	0,05	= e [m]
L [m]	zul P [kN]	zul P [kN]	zul P [kN]	zul P [kN]	min zul P [kN]
2,00	2,00	0,43	1,94	1,87	0,43
3,00	1,32	0,42	1,42	1,27	0,42
4,00	0,98	0,41	1,11	0,95	0,41
5,00	0,77	0,40	0,91	0,75	0,40
6,00	0,63	0,39	0,76	0,61	0,39
7,00	0,53	0,39	0,65	0,51	0,39
8,00	0,45	0,38	0,56	0,44	0,38
9,00	0,39	0,37	0,49	0,38	0,37
10,00	0,33	0,36	0,43	0,33	0,33



### 5.5 Einzellasten in den Fünftelpunkten:

Single-loads in 1/5 points

System

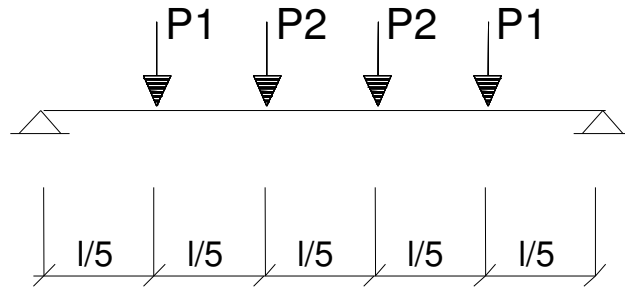

Normalkraft im Gurt:  
Normal force chord

$$\Rightarrow \text{zul } P = [\text{NRd} \cdot (n \cdot b) - \text{gsd} \cdot L^2 / 8] \cdot 5 / 3 / L / yF$$

Normalkraft in der Diagonalen  
Normal force bracing

$$\Rightarrow \text{zul } P = (\text{QRd} - \text{gsd} \cdot L / 2) / 2 / yF$$

Interaktion an der Kupplung:  
Interaction at coupler

$$\Rightarrow (\text{Nsd}_G / \text{NRd}_G)^{1,3} + (\text{Msd}_G / \text{MRd}_G) < 1,0$$

angesetzt: Lasteinleitung an der Kupplung

e = 0,05 m

applied: Loading point at coupler

e = 0,05 m

Belastungstabellen:  
Loading-tables:

### Last in den Fünftelpunkten

Single-load in 1/5points

zulässige Belastung in Abhängigkeit von allowable load as a function of					
	Nrd	Qrd	Interaction at coupler 1	Interaction at coupler 2	
			0,05	0,05	= e [m]
L [m]	zul P [kN]	zul P [kN]	zul P [kN]	zul P [kN]	min zul P [kN]
2,00	1,66	0,32	1,69	1,47	0,32
3,00	1,10	0,32	1,27	1,01	0,32
4,00	0,81	0,31	1,01	0,77	0,31
5,00	0,64	0,30	0,83	0,61	0,30
6,00	0,52	0,30	0,70	0,50	0,30
7,00	0,44	0,29	0,60	0,42	0,29
8,00	0,37	0,28	0,52	0,36	0,28
9,00	0,32	0,28	0,46	0,31	0,28
10,00	0,28	0,27	0,41	0,27	0,27



## 6 ZUSAMMENFASSUNG DER ERGEBNISSE

### SUMMARY OF THE RESULTS

#### 6.1 Zulässige Belastung:

Allowable loadings

### Zulässige Belastung F23

Einfeldträger / single-span beam

allowable load F23

Spannweite	UDL	Einzellasten / Single point loads			
		in 1/2 Punkt	in 1/3 Punkten	in 1/4 Punkten	in 1/5 Punkten
Span	UDL	in 1/2 Point	in 1/3 Points	in 1/4 Points	in 1/5 Points
[m]	[kN/m]	[kN]	[kN]	[kN]	[kN]
2	0,65	1,29	0,65	0,43	0,32
3	0,42	1,27	0,63	0,42	0,32
4	0,31	1,24	0,62	0,41	0,31
5	0,24	1,21	0,61	0,40	0,30
6	0,20	1,18	0,59	0,39	0,30
7	0,17	1,00	0,58	0,39	0,29
8	0,14	0,86	0,57	0,38	0,28
9	0,12	0,74	0,55	0,37	0,28
10	0,11	0,65	0,48	0,33	0,27

Die Tabellenwerte gelten nur für das System eines Einfeldträgers.  
The values of the table are only valid for single-span girder.

Die Traversenelemente müssen mit Diagonalen ausgebildet sein.  
The truss-elements have to be braced with diagonals.

Die Einzellasten sind an den Knoten einzuleiten oder über geeignete zusätzliche Konstruktionen zu verteilen.  
Large loads have to be applied at the nodes or have to be distributed by appropriate constructions.

Lasten mittig auf den Kupplungen sind nicht zulässig.  
Loads at the middle of the couplers are not allowed.

Alle Lasten sind gleichmäßig auf beide Gurte zu verteilen.  
All loads have to be distributed equally to both chords.

In den angegebenen Werten der Tabelle sind Teilsicherheitsbeiwerte auf der Lastseite nach EN 1990 mit einem  $\gamma_F = 1,50$  für Nutzlasten und  $\gamma_G = 1,35$  für das Eigengewicht der Traversen berücksichtigt.  
The specified values include partial safety coefficients on the loadings side acc. EN 1990 of  $\gamma_F = 1.50$  for payloads and  $\gamma_G = 1.35$  for selfweight of the truss.

Bei Anwendungsfällen, die auf Grundlage anderer Normen berechnet werden, können die Teilsicherheitsbeiwerte auf der Lastseite angepasst werden (z.B. fliegende Bauten nach EN 13814,  $\gamma_F = 1,35$  für Nutzlasten).  
For applications which can be calculated on the basis of other codes, the partial safety factors can be adjusted (for example temporary structures acc. EN 13814,  $\gamma_F = 1.35$  for payloads).

Bei Anwendung des British Standard (BS) und des ANSI müssen die in den Tabellen aufgeführten zulässigen Belastungen mit dem Faktor 0,85 multipliziert werden.  
To use the resulting allowable loads with British Standard (BS) and ANSI, allowable loads listed in tables have to be multiplied by 0.85.



## 6.2 Vorhandene Durchbiegung unter max. Belastung:

Deflections at max. allowable loadings

### Vorhandene Durchbiegung [cm] F23 unter max. zul. Lasten

Deflections [cm] for F23 at max. allowable loads

[cm]

Spannweiten	UDL	Einzellasten / Single point loads			
		in 1/2 Punkt	in 1/3 Punkten	in 1/4 Punkten	in 1/5 Punkten
Span	UDL	in 1/2 Point	in 1/3 Points	in 1/4 Points	in 1/5 Points
[m]	[cm]	[cm]	[cm]	[cm]	[cm]
2	0,07	0,11	0,09	0,09	0,08
3	0,23	0,36	0,31	0,29	0,28
4	0,55	0,85	0,73	0,68	0,65
5	1,07	1,65	1,42	1,33	1,28
6	1,86	2,83	2,45	2,29	2,20
7	2,96	3,93	3,87	3,63	3,49
8	4,43	5,22	5,76	5,41	5,20
9	6,32	6,71	8,17	7,68	7,39
10	8,69	8,42	10,23	9,77	10,12

 = Durchbiegung  $\geq L/100$   
deflection  $\geq L/100$

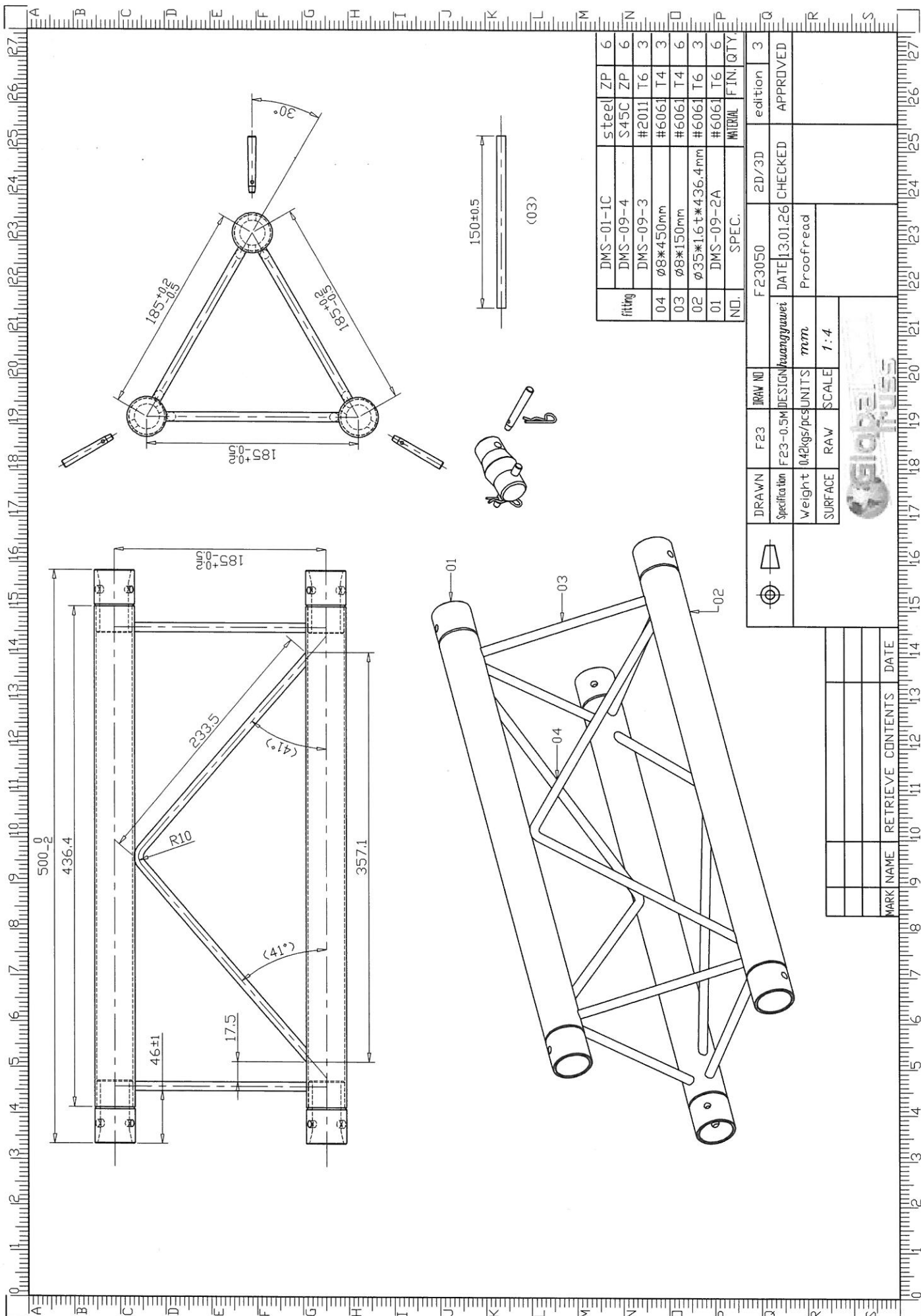

fitting	DMS-01-1C	steel	ZP	6	
	DMS-09-4	S45C	ZP	6	
	DMS-09-3	#2011	T6	3	
	04	ø8*450mm	#6061	T4	3
	03	ø8*150mm	#6061	T4	6
	02	ø35*1.6t*436.4mm	#6061	T6	3
	01	DMS-09-2A	#6061	T6	6
ND.	SPEC.	MATERIAL	FIN.	QTY	

DRAWN	F23	DRAW NO	F23050	2D/3D	edition	3	
Specification	F23-0.5M	DESIGN	huangyuwei	DATE	13.01.26	CHECKED	APPROVED
Weight	0.42kgs	PCS	UNITS	mm	Proofread		
SURFACE	RAW	SCALE	1:4				

MARK NAME	RETRIEVE	CONTENTS	DATE



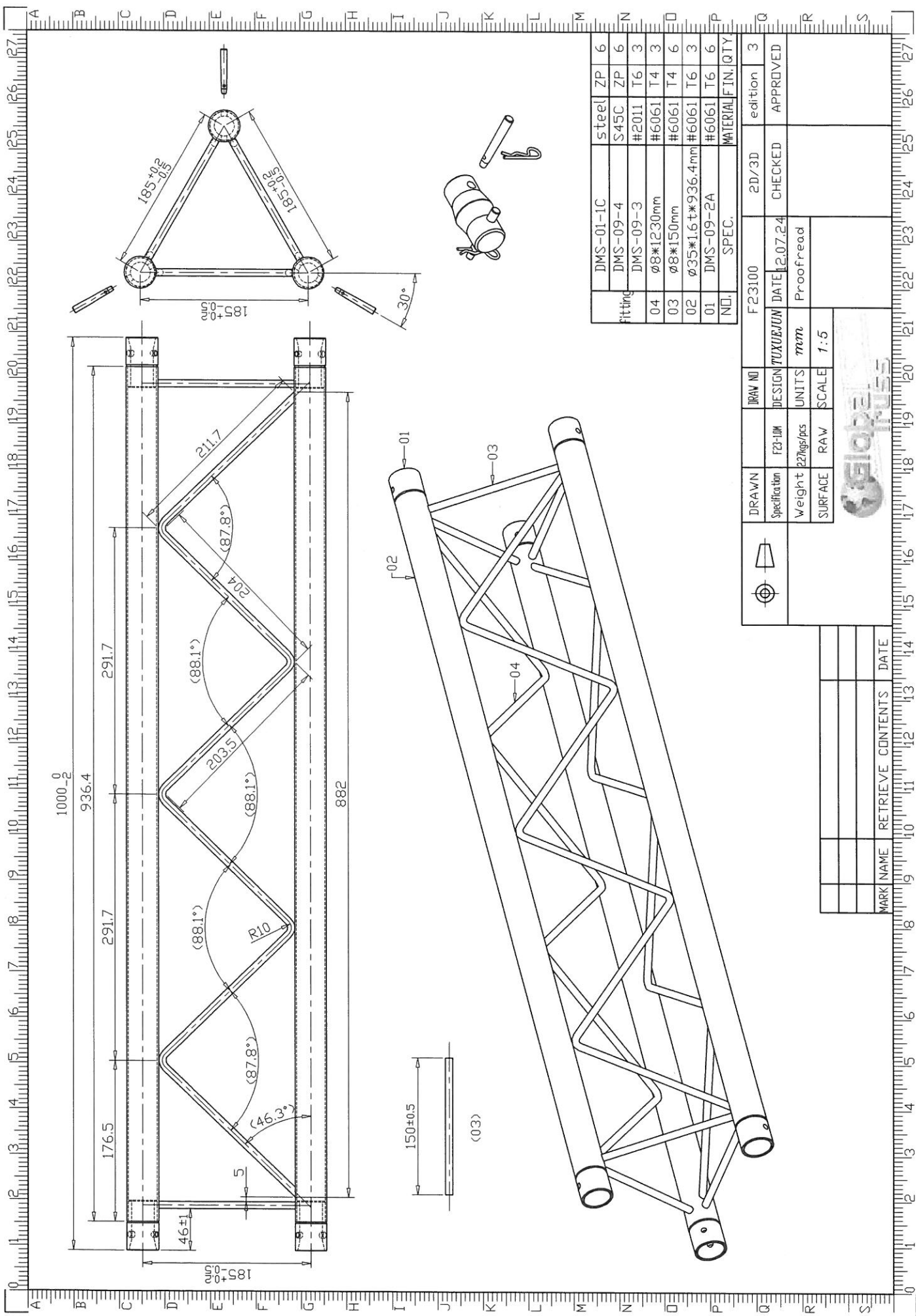

fitting	DMS-01-1C	steel	ZP	6
	DMS-09-4	S45C	ZP	6
	DMS-09-3	#2011	T6	3
04	Ø8*1230mm	#6061	T4	3
03	Ø8*150mm	#6061	T4	6
02	Ø35*1.6t*936.4mm	#6061	T6	3
01	DMS-09-2A	#6061	T6	6
NO.	SPEC.	MATERIAL	FIN.	QTY

DRAWN	DESIGN	DATE	2D/3D	edition
Specification	TUXUEJUN	12.07.24	CHECKED	APPROVED
Weight	UNITS	Proofread		
227kg±5	mm			
SURFACE	RAW	SCALE		
		1:5		

MARK NAME	RETRIEVE	CONTENTS	DATE

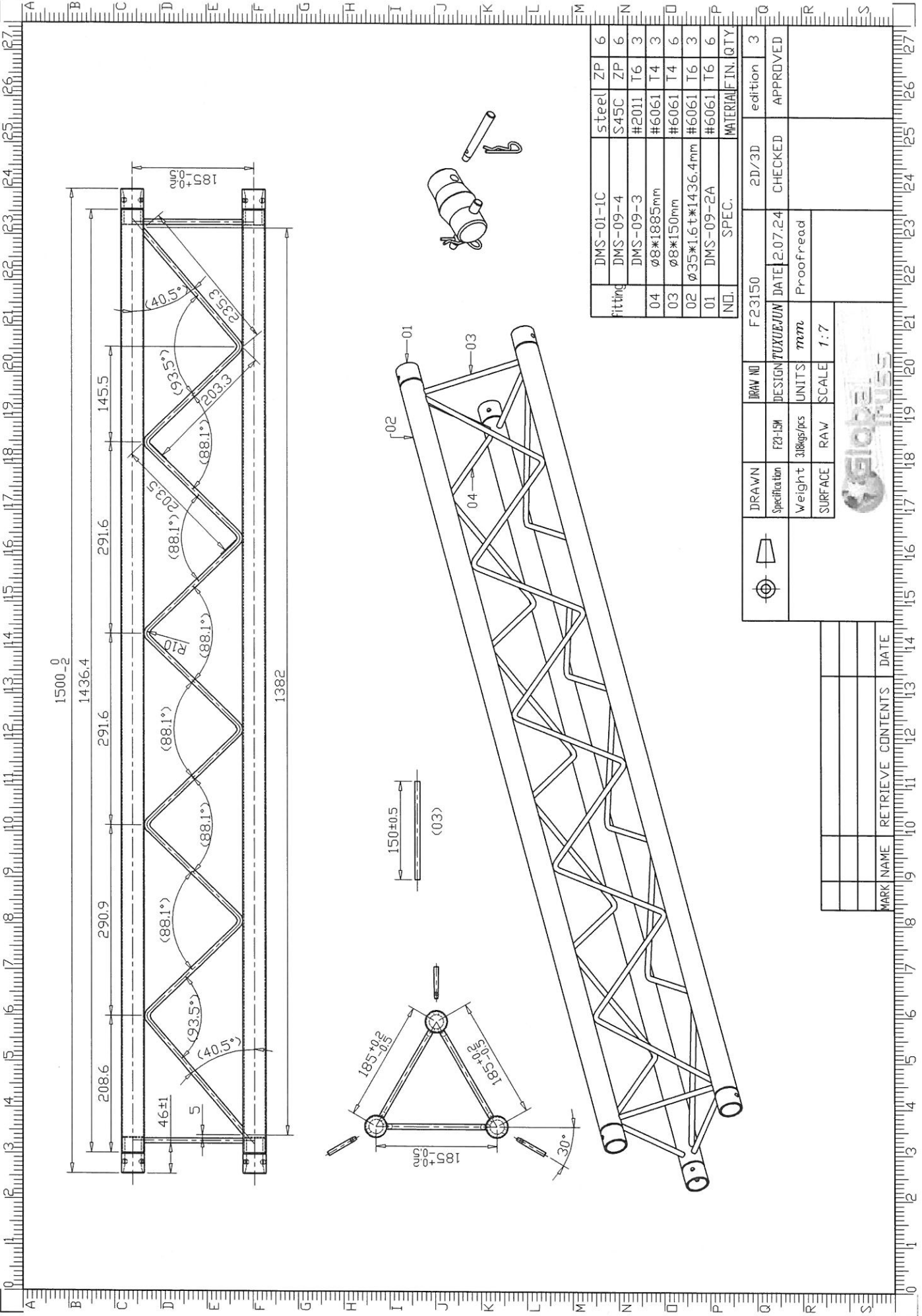

Fitting	DMS-01-1C	steel	ZP	6
	DMS-09-4	S45C	ZP	6
	DMS-09-3	#2011	T6	3
04	ø8*1885mm	#6061	T4	3
03	ø8*150mm	#6061	T4	6
02	ø35*1.6t*1436.4mm	#6061	T6	3
01	DMS-09-2A	#6061	T6	6
NO.	SPEC.	MATERIAL	FIN.	QTY

DRAWN	Specification	DESIGN	TUXUEJUN	DATE	2.07.24	CHECKED	APPROVED
Weight	318kg/pcs	UNITS	mm	Proofread			
SURFACE	RAW	SCALE	1:7				



MARK NAME	RETRIEVE CONTENTS	DATE



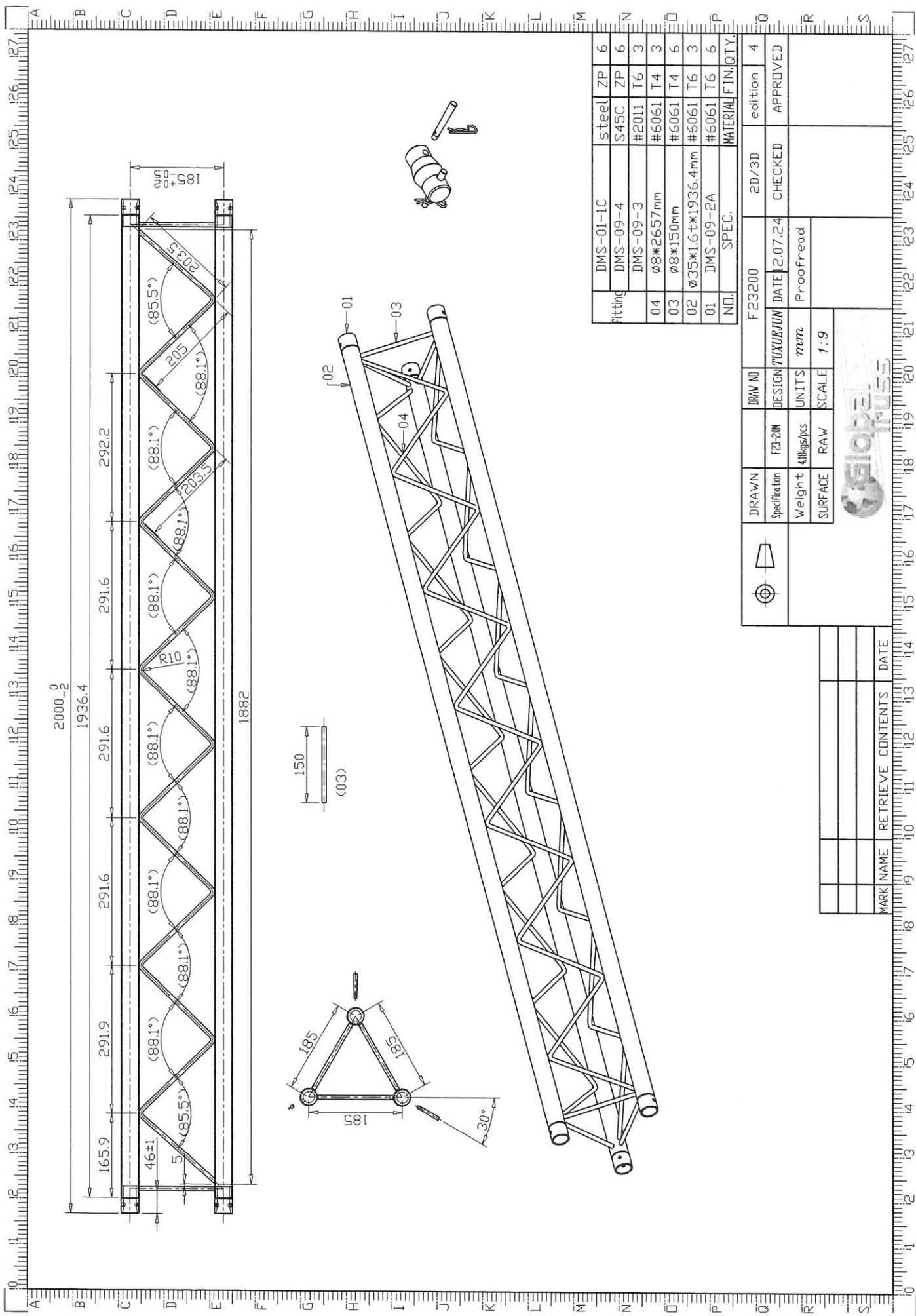

Fitting	DMS-01-1C	steel	ZP	6
	DMS-09-4	S45C	ZP	6
	DMS-09-3	#2011	T6	3
04	Ø8*2657mm	#6061	T4	3
03	Ø8*150mm	#6061	T4	6
02	Ø35*1.6t*1936.4mm	#6061	T6	3
01	DMS-09-2A	#6061	T6	6
ND.	SPEC.	MATERIAL FIN. QTY.		

DRAWN	DESIGN	DATE	2D/3D	edition
Specification	TUXUEJUN	2.07.24	CHECKED	APPROVED
Weight	UNITS	Proofread		
418kgs/pcs	mm			
SURFACE	RAW	SCALE		
		1:9		

MARK NAME	RETRIEVE	CONTENTS	DATE



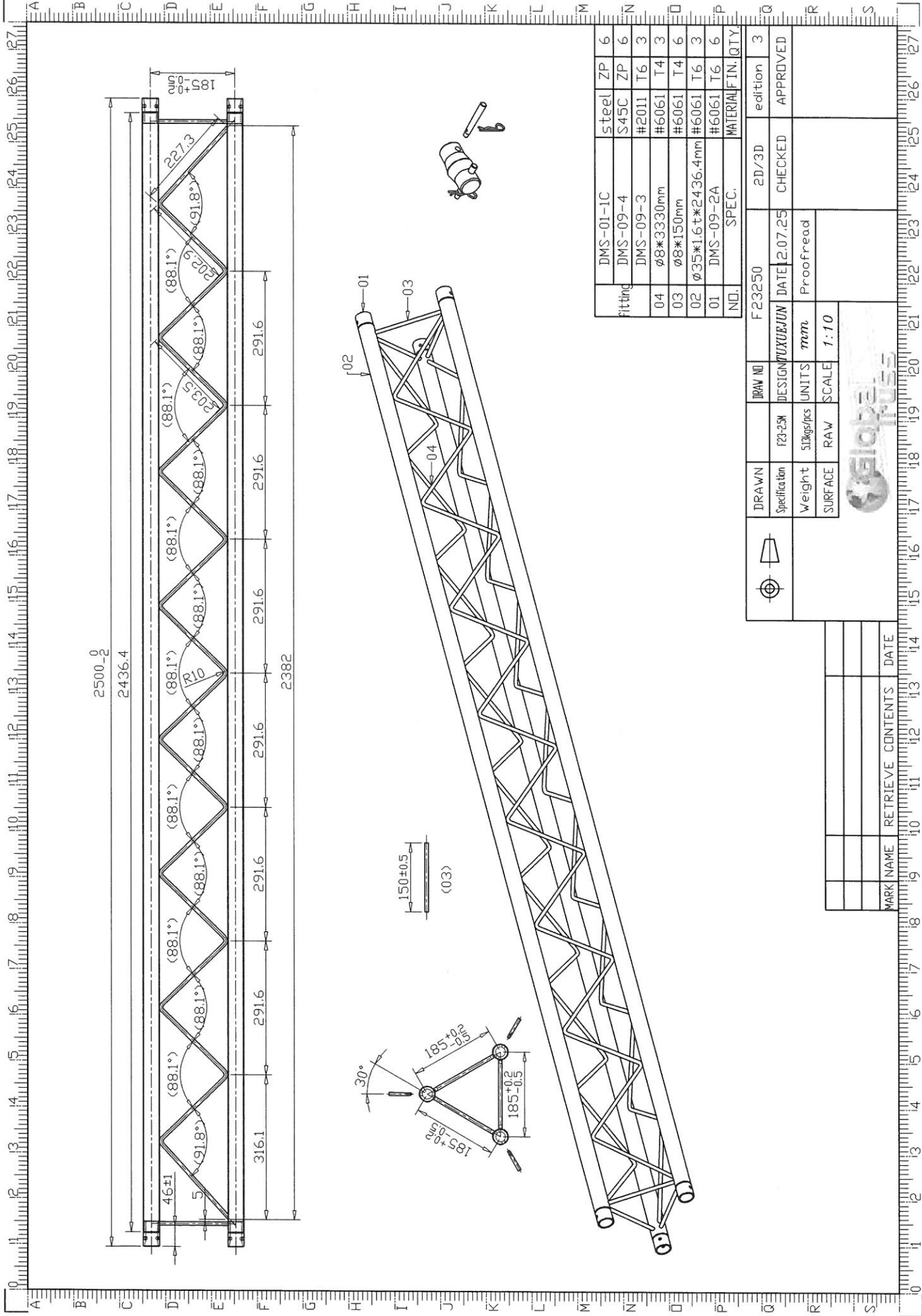

fitting	DMS-01-1C	steel	ZP	6
	DMS-09-4	S45C	ZP	6
	DMS-09-3	#2011	T6	3
04	ø8*3330mm	#6061	T4	3
03	ø8*150mm	#6061	T4	6
02	ø35*1.6t*2436.4mm	#6061	T6	3
01	DMS-09-2A	#6061	T6	6
NO.	SPEC.	MATERIAL	FIN.	QTY.

DRAWN	Specification	F23-25N	DESIGN	TUXUE/JUN	DATE	2.07.25	2D/3D	edition	3
Weight	5.0kgs/mts	UNITS	mm	Proofread	CHECKED	APPROVED			
SURFACE	RAW	SCALE	1:10						

MARK NAME	RETRIEVE CONTENTS	DATE



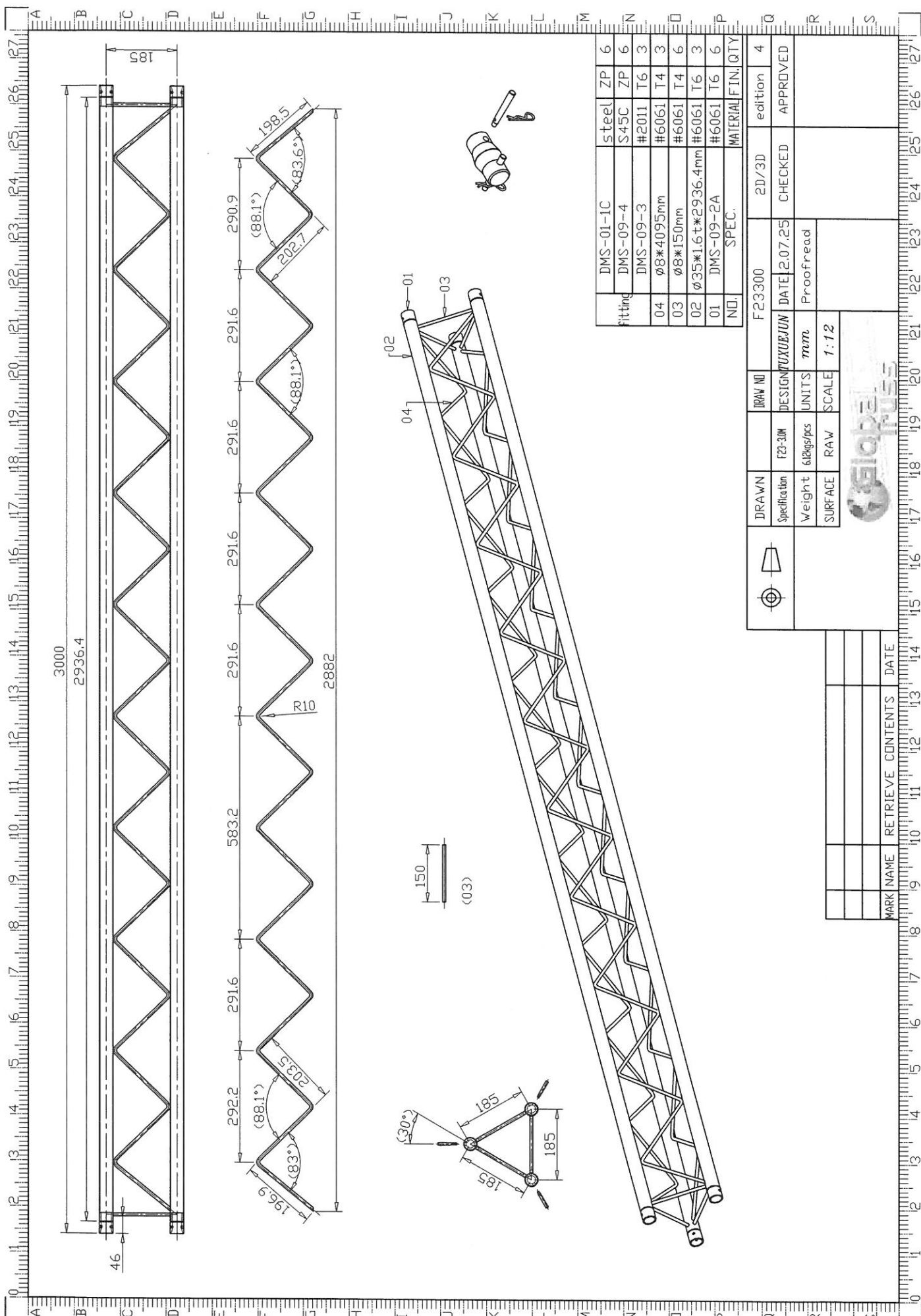

fitting	DMS-01-1C	steel	ZP	6	
	DMS-09-4	S45C	ZP	6	
	DMS-09-3	#2011	T6	3	
	04	ø8*40*5mm	#6061	T4	3
	03	ø8*150mm	#6061	T4	6
	02	ø35*1.6t*2936.4mm	#6061	T6	3
	01	DMS-09-2A	#6061	T6	6
NO.	SPEC.	MATERIAL	FIN.	QTY	

DRAWN	DESIGN	TRAV	NO.	F23300	2D/3D	edition	4
Specification	F23-30M	DATE	2.07.25	CHECKED	APPROVED		
Weight	612kgs/pcs	UNITS	mm	Proofread			
SURFACE	RAW	SCALE	1:12				

MARK NAME	RETRIEVE	CONTENTS	DATE

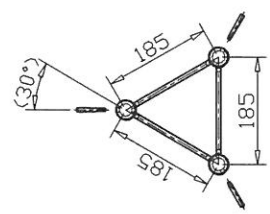
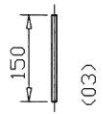
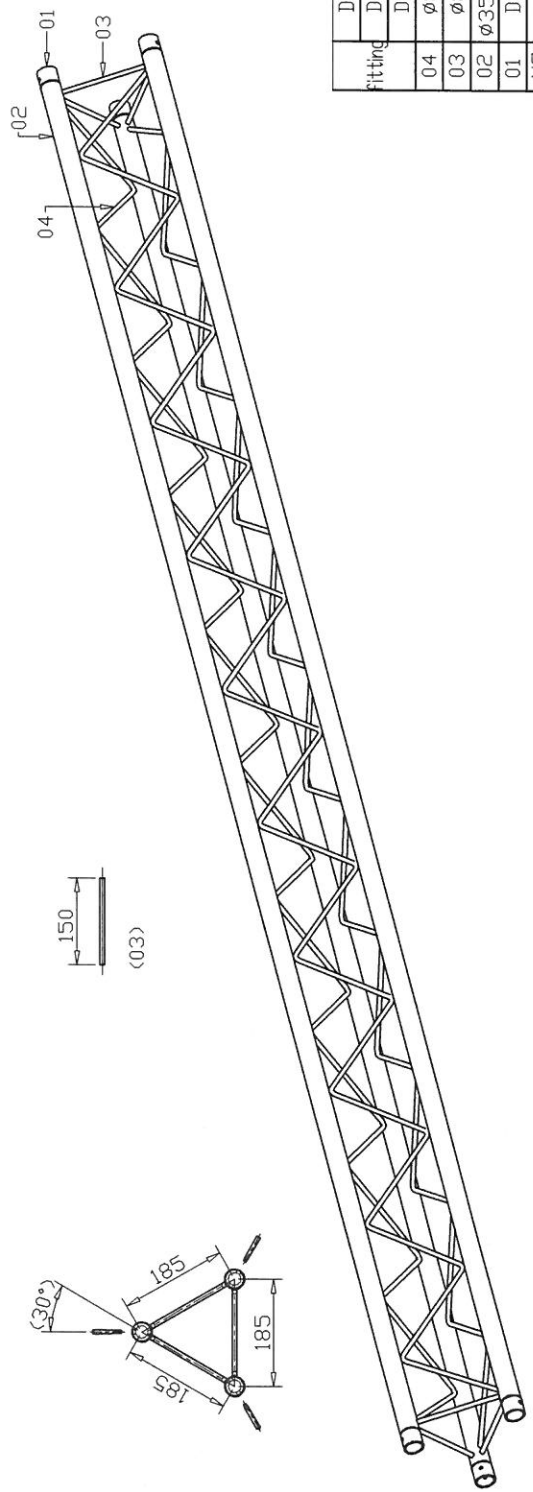
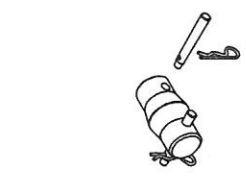

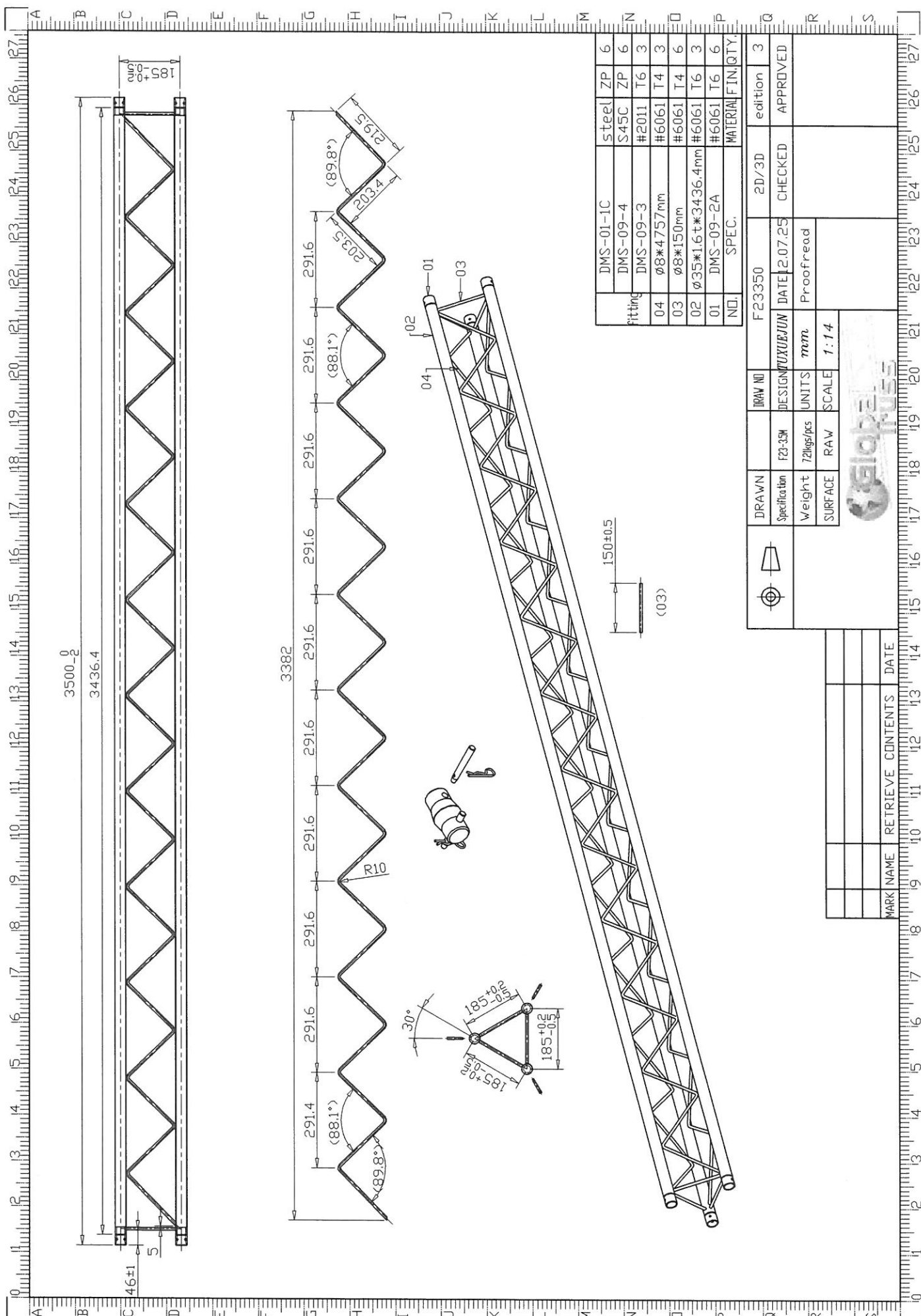

DMS-01-1C	Steel	ZP	6	
DMS-09-4	S45C	ZP	6	
DMS-09-3	#2011	T6	3	
04	∅8*4757mm	#6061	T4	3
03	∅8*150mm	#6061	T4	6
02	∅35*1.6t*3436.4mm	#6061	T6	3
01	DMS-09-2A	#6061	T6	6
NO.	SPEC.	MATERIAL FIN.	QTY.	

DRAWN	Specification	F23-35M	DESIGN	TUYUE/JUN	DATE	2.07.25	2D/3D	edition	3
Weight	72kgs/pcs	UNITS	mm	Proofread					
SURFACE	RAW	SCALE	1:14						

MARK NAME	RETRIEVE	CONTENTS	DATE



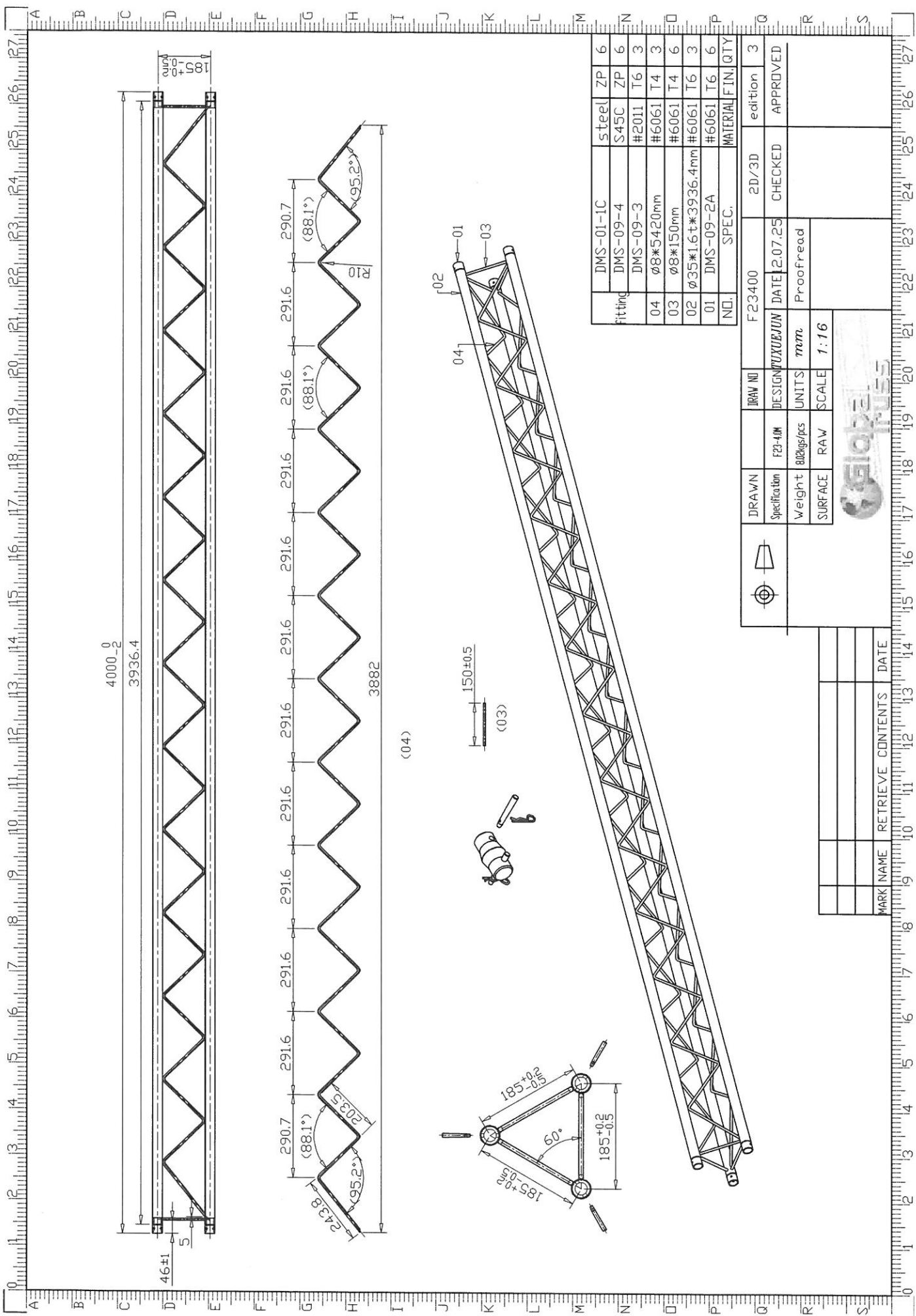

fitting	DMS-01-1C	steel	ZP	6
	DMS-09-4	S45C	ZP	6
	DMS-09-3	#2011	T6	3
04	ø8*5420mm	#6061	T4	3
03	ø8*150mm	#6061	T4	6
02	ø35*1.6t*3936.4mm	#6061	T6	3
01	DMS-09-2A	#6061	T6	6
NO.	SPEC.	MATERIAL FIN.	QTY	

DRAWN	DESIGN	DRAW NO	F 23400	2D/3D	edition	3
Specification	DATE	2.07.25	CHECKED	APPROVED		
Weight	UNITS	mm	Proofread			
SURFACE	SCALE	1:16				

MARK NAME	RETRIEVE	CONTENTS	DATE



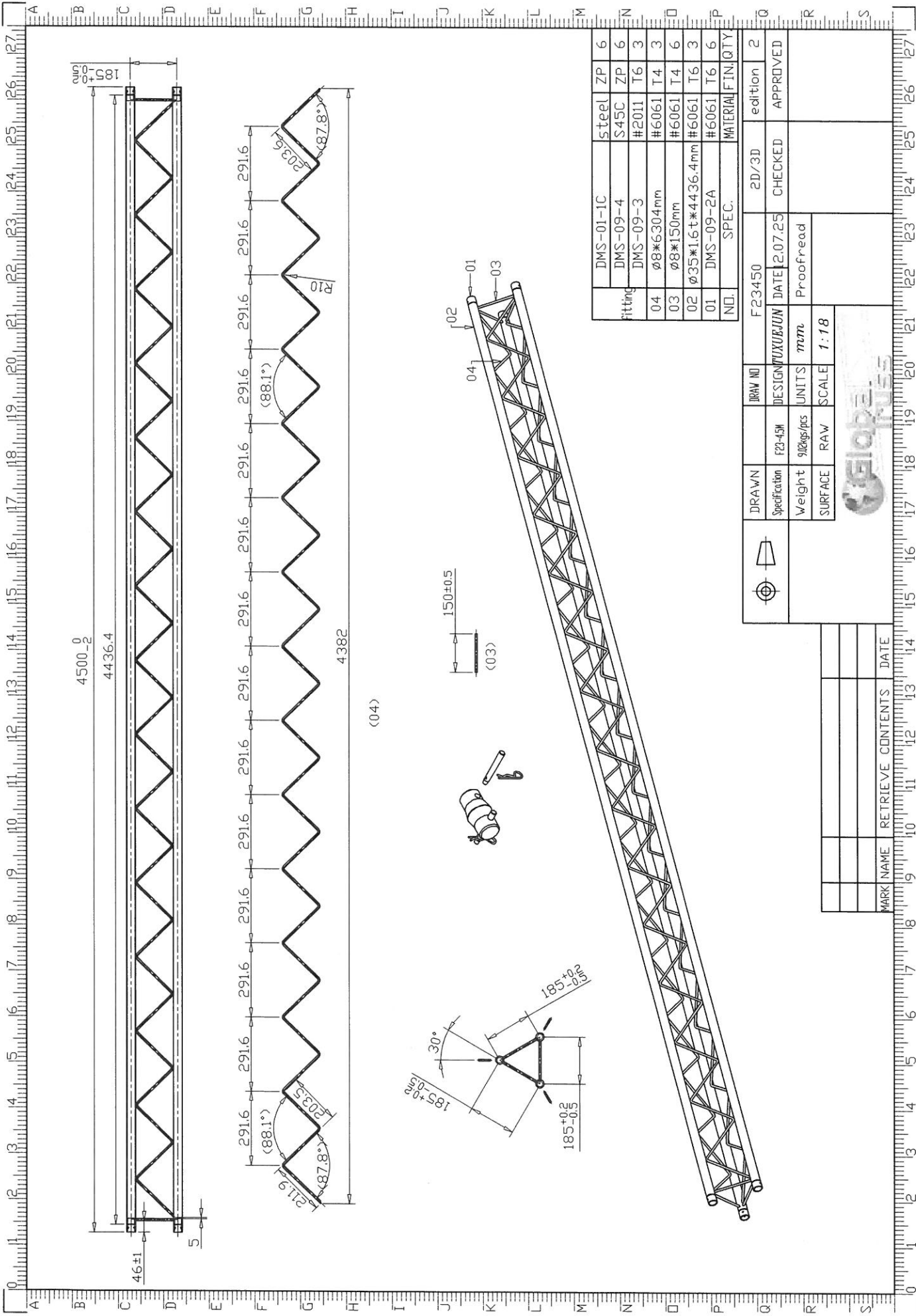

fitting	Steel	ZP	6
	S45C	ZP	6
	#2011	T6	3
04	∅8*6304mm	#6061	T4
03	∅8*150mm	#6061	T4
02	∅35*1.6t*4436.4mm	#6061	T6
01	DMS-09-2A	#6061	T6
NO.	SPEC.	MATERIAL	FIN.QTY

DRAWN	DRW NO	F23450	2D/3D	edition	2
Specification	DESIGN	F23-45H	DATE	2.07.25	CHECKED
Weight	UNITS	922kgs/pcs	mm	Proofread	APPROVED
SURFACE	RAW	SCALE	1:18		

MARK NAME	RETRIEVE CONTENTS	DATE



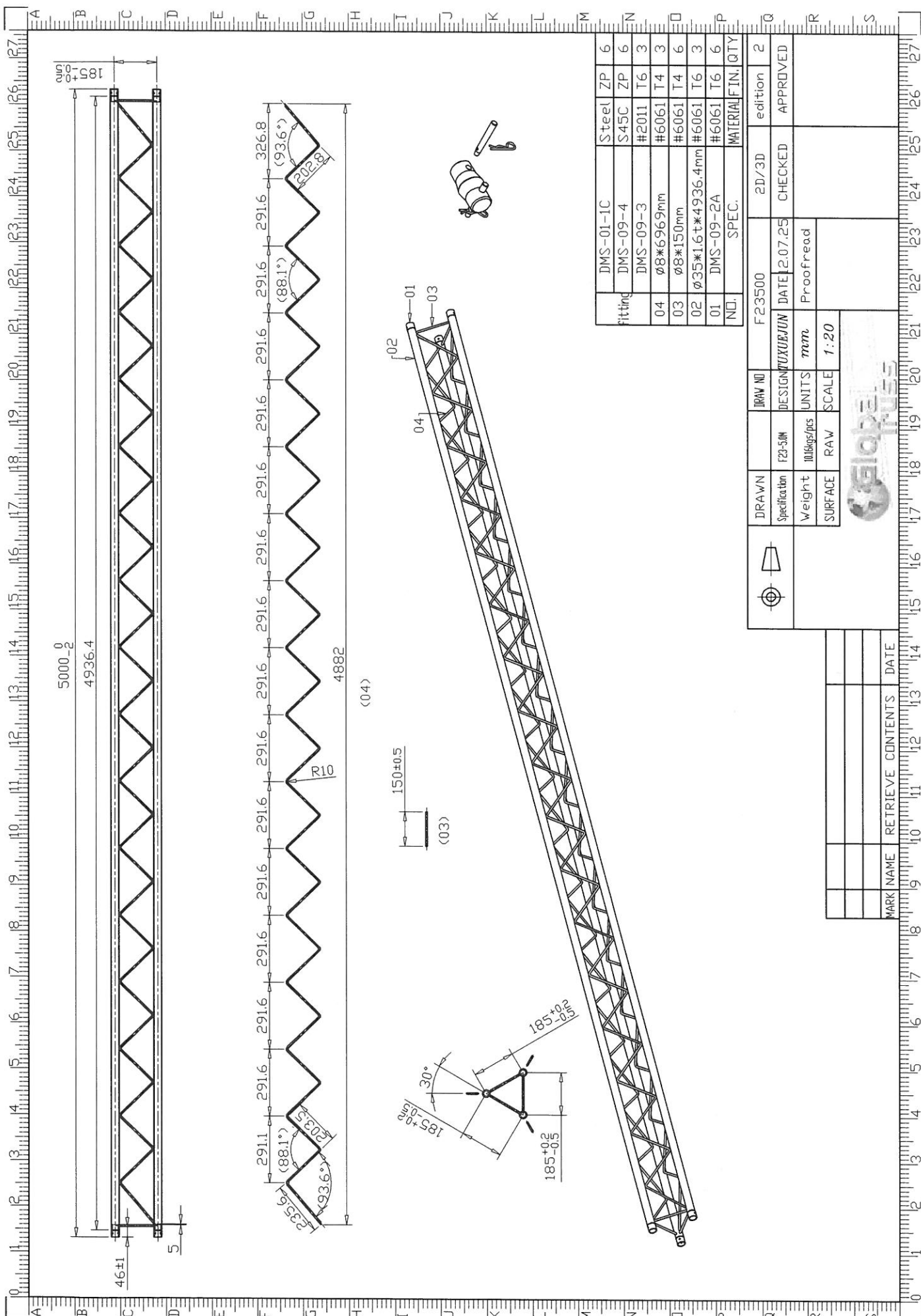

fitting	DMS-01-1C	Steel	ZP	6
	DMS-09-4	S45C	ZP	6
	DMS-09-3	#2011	T6	3
04	∅8*696.9mm	#6061	T4	3
03	∅8*150mm	#6061	T4	6
02	∅35*1.6t*4936.4mm	#6061	T6	3
01	DMS-09-2A	#6061	T6	6
NO.	SPEC.	MATERIAL	FIN.	QTY

DRAWN	Specification	Weight	SURFACE	RAW	SCALE	1:20
DESIGN	F23-5/IN	UNITS	mm	PROOFREAD		
DATE	2.07.25	CHECKED	APPROVED	edition	2	
DRAW NO	F23500	2D/3D				

MARK NAME	RETRIEVE	CONTENTS	DATE

