

Parts List and Wiring Diagrams

Model PH-88 Headset



The PH-88 headset is a super lightweight, single sided headset for the ultimate in day-long comfort. The PH-88 features a high quality monaural dynamic earphone with dynamic noise cancelling microphone on an adjustable boom that can be bent to practically any mouth-to-mic position. The unit has a straight cord and is available in various connector configurations.

Specifications

Receiver Type Dynamic
 Receiver Impedance 300 ohms
 Microphone Type Dynamic
 Microphone Impedance 200 ohms
 Weight 4.6 ozs
 Cord 6 ft. straight

Parts List

ITEM NO.	DESCRIPTION	QTY	PART NO.
1	Windscreen	1	59835-000
2	PT-Pan Head Screw, KA15 x 6(.236) LG., Black	2	590404-360
3	Glider Spring	2	64305-000
4	Housing Assy.	1	64308-107
5	Glider Assy.	1	64310-000
6	Cord Amp Assy.	1	64311-053
7	Boom Mic / Housing Assy.	1	800499-100
8	Headband Assy.	1	64352-026
9	Temple Plate	1	70531-003
10	Foam Pad	1	70533-000
11	Ear Cushion	1	590626-000
12	Connector, PH-88 & PH-88E, XLR-4F	1	35320-004
	Connector, PH-88R, XLR-4M	1	35398-004
	Connector, PH-88R5, XLR-5M	1	35398-005

Exploded View

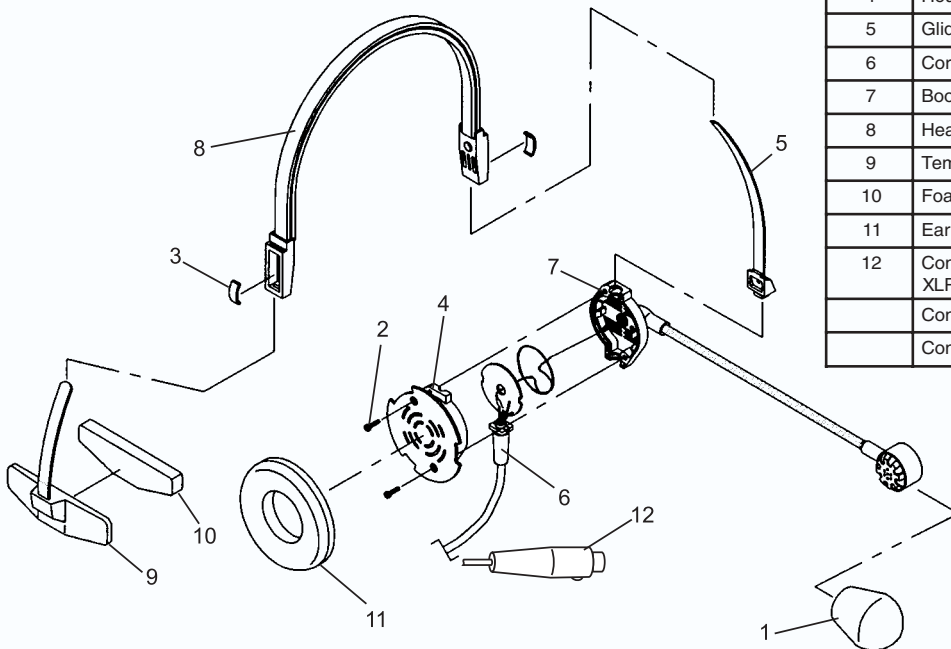

Wiring Diagram

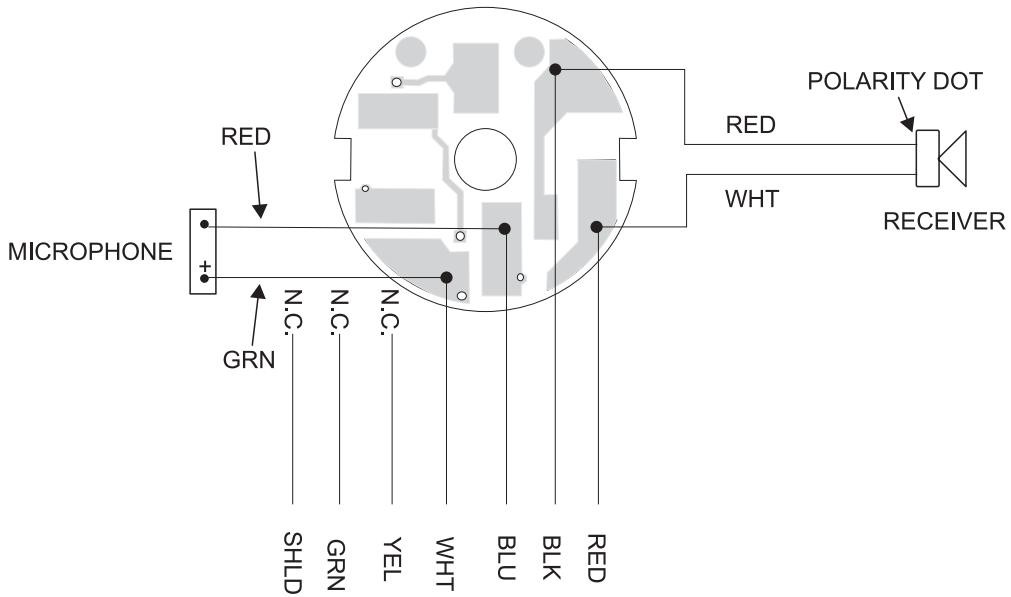

Connector Wiring

PH-88 / PH-88E

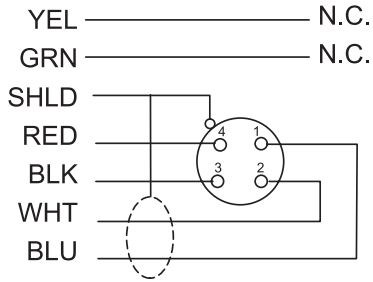
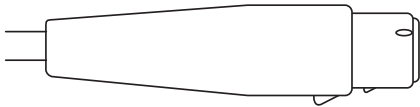

300852-200, -203

PH-88R

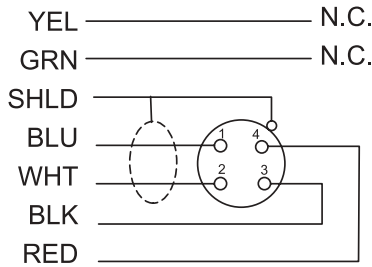
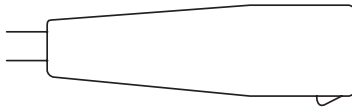

300852-201

PH-88R5

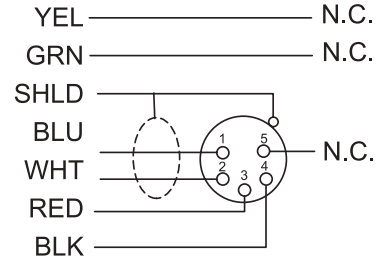
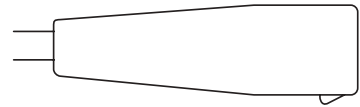

300852-202