

4PRO 2031-A

ACTIVE TWO-WAY SPEAKER



MAIN APPLICATIONS

- Sound reinforcement systems
- Band and vocal PA
- DJ PA systems
- Small to medium size venue Main PA

MAIN FEATURES

- 1200 WATT PEAK, 600 WATT RMS
- 129 dB max spl
- 90 x 60, Wide dispersion constant directivity horn
- 12" woofer, 2.5" voice coil
- 1" HF driver, 1.7" voice coil

DESCRIPTION

The 4PRO 2031-A is a two-way active bass reflex loudspeaker offering exceptional full range and accurate reproduction.

It integrates a 600 Watt digital bi-amplification, a complete electronic processor section and RCF low distortion, high power transducers. The system is compact and extremely linear and offers the typical balanced sound of high level two way systems.

The 90° angle is wide enough to provide coverage of an audience when used one per side, yet narrow enough to allow displaying of multiple enclosures without excessive coverage overlap.

The 12" woofer delivers a fast and accurate reproduction of the midbass frequency range and controlled deep bass while the 1" compression driver offers a very open and natural midrange sound and extreme precision high frequencies reproduction. The 4PRO 2031-A comprises a 12" woofer and a 1.7" voice coil compression driver that is mounted to a 90° x 60° constant directivity horn.

4PRO 2031-A are equipped with a new generation of 600 Watt Digital Amplifier, 400 Watt for the woofer and 200 Watt for the compression driver. The result of this is very high output, extremely low distortion and an incredible natural sound. The amplifier presents both XLR/jack (Combo) balanced inputs, XLR output link, volume, a switchable EQ Mode (Contour) and a mic/line switch. The amplifier features a solid mechanical aluminium structure which not only stabilize the amplifier during transportation but also assist in the heat dissipation.

The processor section includes active crossover, system equalization, transducer phase alignment, limiter and protection functions. The system is visually monitored from 4 status LEDs. All components are housed in a strong Baltic birch plywood enclosure where high density polystyrene end caps guarantee the maximum strength.

The front is protected from a strong, powder coated, metal grille. The cabinet features two comfortable recessed side handles for easy portability.

ACOUSTICAL SPECIFICATIONS

Frequency response:	45 Hz- 20 KHz
Max SPL:	129 dB
Horizontal coverage angle:	90°
Vertical coverage angle:	60°
Compression driver:	1", 1.7" v.c.
Midrange:	-
Woofer:	12", 2,5" v.c.

INPUT SECTION

Input connector:	Combo XLR-JCK
Output connector:	XLR
Input sensitivity:	-2 dBu / + 4 dBu

PROCESSOR SECTION

Crossover frequencies:	1700 Hz
Protections:	Themel, RMS
Limiter:	Fast limiter
Controls:	Volume, EQ Shape, Mic/Line

AMPLIFIER

Power supply:	600 Watt
---------------	----------

High frequencies:	200 Watt
Mid frequencies:	-
Low frequencies:	400 Watt
Cooling:	Convection
Connection:	VDE connector IN/OUT

PHYSICAL

Height:	627 mm (24.68")
Width:	380 mm (14.96")
Depth:	380 mm (14.96")
Weight:	22.2 Kg (48.94 lbs)
Cabinet:	Baltic Birch
Hardware:	3 x Flytracks

Handles:	2 side
Pole mount cap:	yes
Colour:	Black



4PRO 2031-A

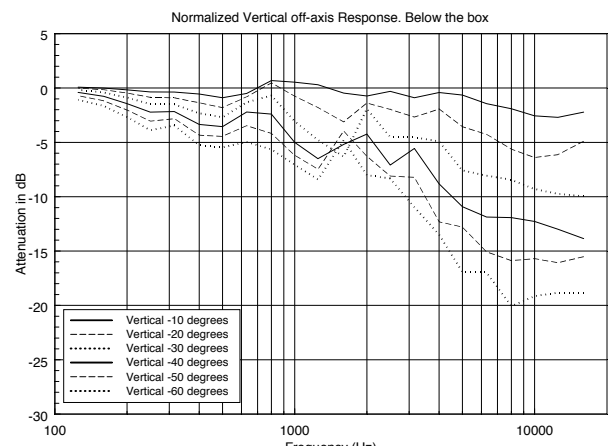
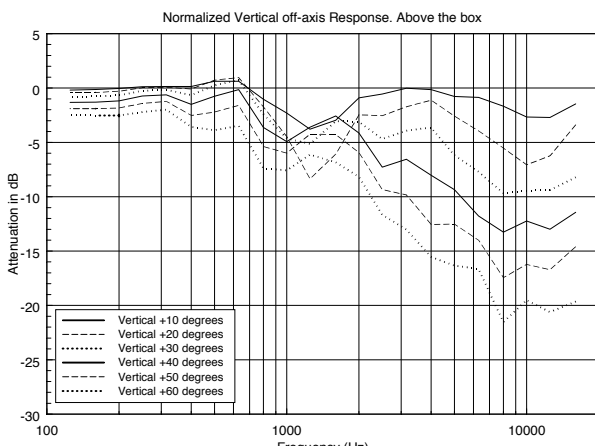
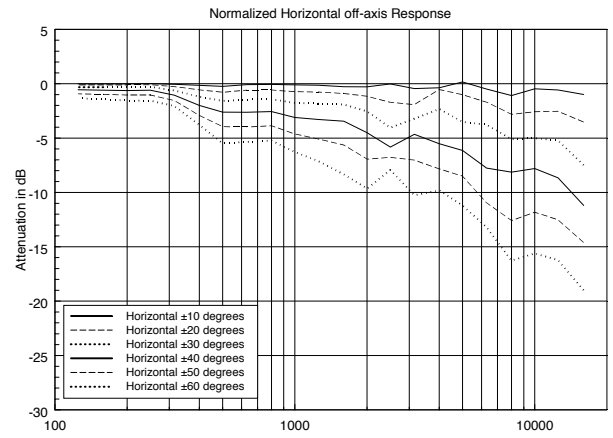
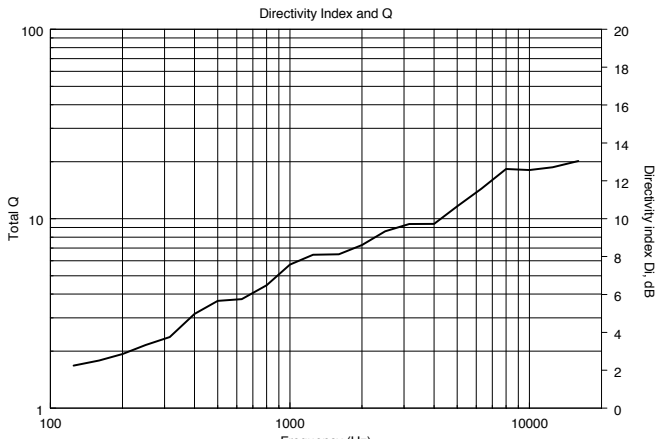
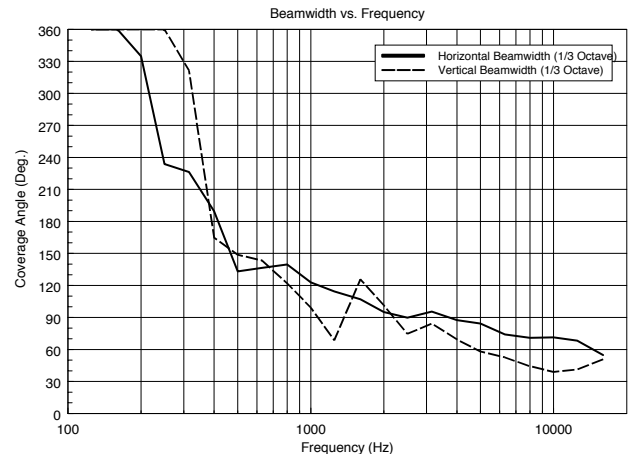
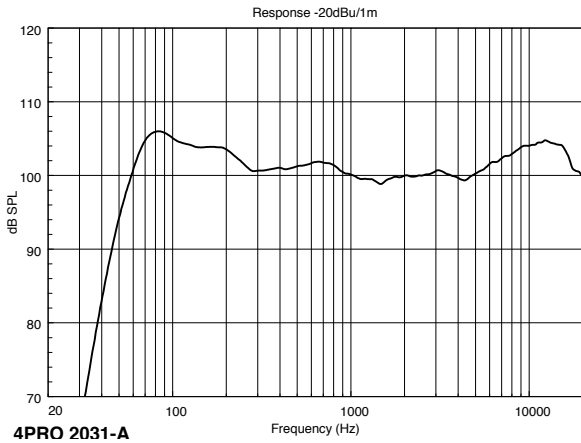

4PRO 2031-A

HORIZONTAL 1/3 POLAR PLOT

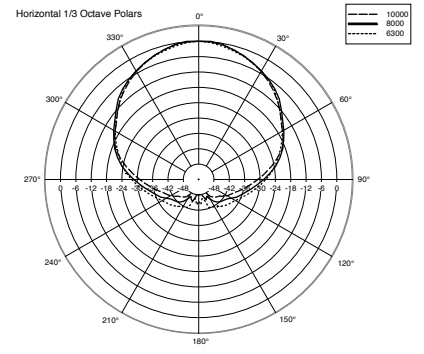
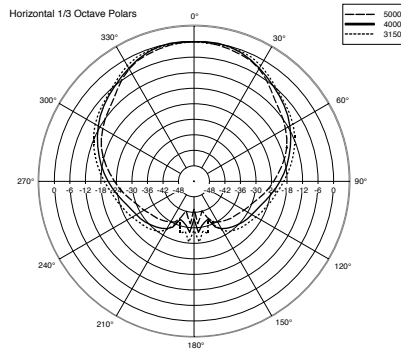
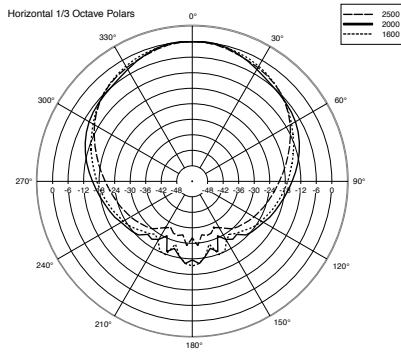
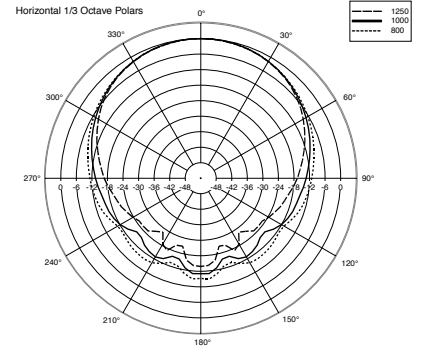
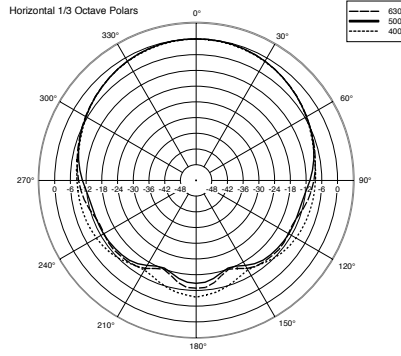
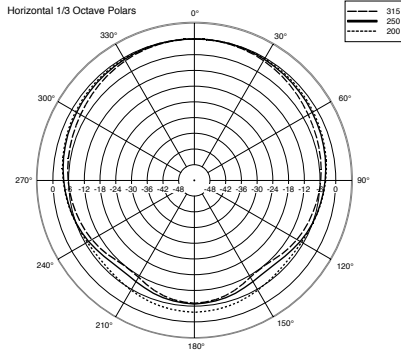

VERTICAL 1/3 POLAR PLOT

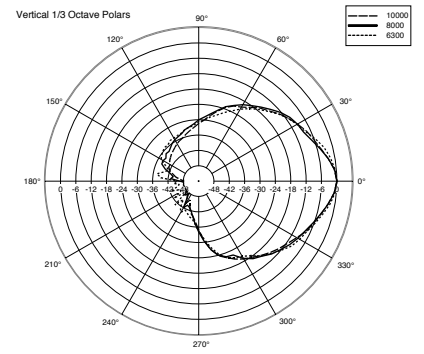
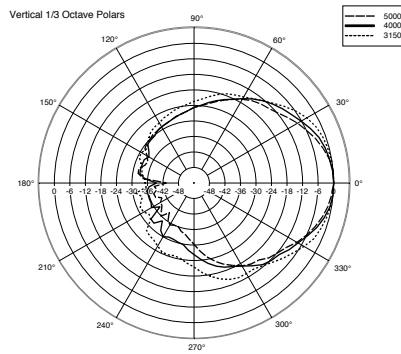
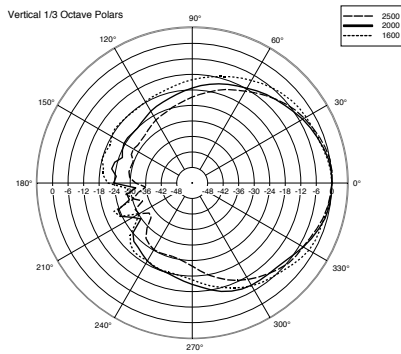
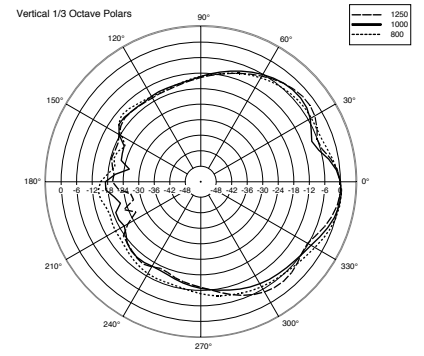
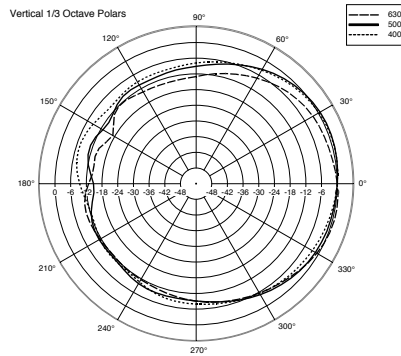
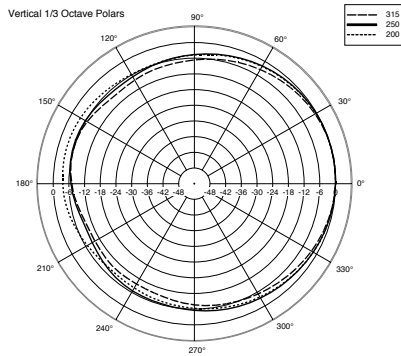

4PRO 2031-A

1.0-J-F

PART NUMBERS

13000364 - 230VOLT

13000365 - 115 VOLT

DIMENSIONS (All data are in mm)

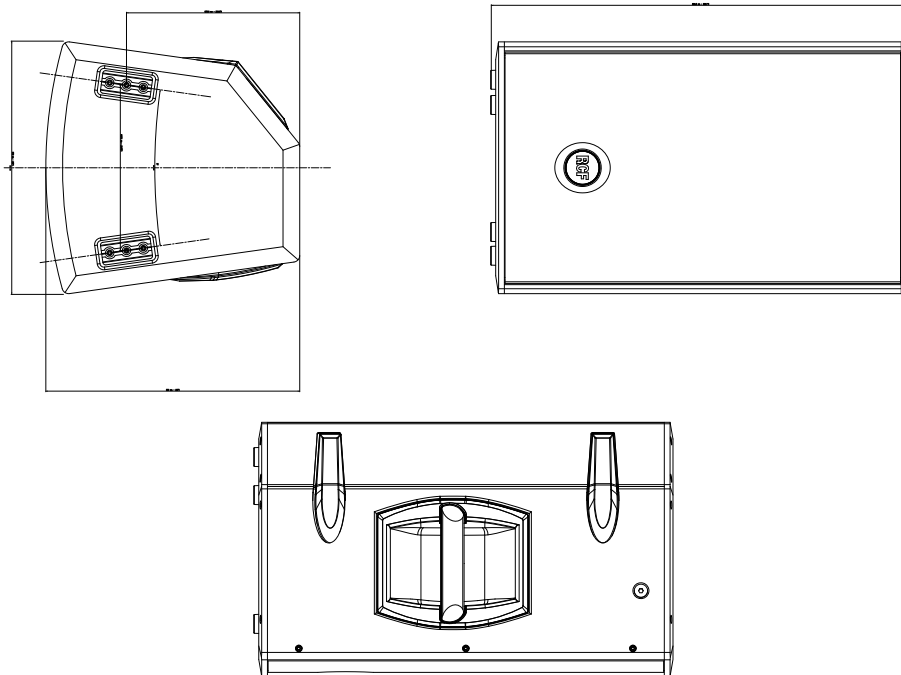

ACCESSORIES

AC DS4X	4 Hooks Kit
AC PMA	Speaker Pole Mount
AC PRO-FS	Professional Loudspeaker Floor Stand
AC PRO-LF	Professional Adapter Sleeve
AC PRO-PM	Pole Mount with Ring Lock
AC S140	Floor Stand for Loudspeakers
AC PMX	Speaker Pole Mount
AC S260	Floor Stand for Loudspeakers