

Quick Start Guide

This quick start guide contains important information on the safe operation of the product. Read and follow the safety advice and instructions given. Retain the manual for future reference. If you pass the product on to others please include this manual.

Safety instructions

Intended use

This device is used to shield unwanted noise and room acoustics from microphone recordings. Any other use or use under other operating conditions is considered to be improper and may result in personal injury or property damage. No liability will be assumed for damages resulting from improper use.

Danger for children



Ensure that plastic bags, packaging, etc. are disposed of properly and are not within reach of babies and young children. Choking hazard! Ensure that children do not detach any small parts from the product. They could swallow the pieces and choke!

Where to use the product

Never use the product

- in conditions of extreme temperature or humidity
- in extremely dusty or dirty areas
- at locations where the unit can become wet

General handling

- To prevent damage, never use force when handling the product.
- Never immerse the product in water. Just wipe it with a clean dry cloth. Do not use liquid cleaners such as benzene, thinners or flammable cleaning agents.

Set-up

- 1) First make sure the scope of delivery is complete:

- A) Microphone screen (310 × 230 mm)
 B) Handscrew for screen
 C) Support arm for the screen
 D) Mic support arm
 E) Sliding assembly
 F) Base plate (222 × 234 mm)
 G) End cap

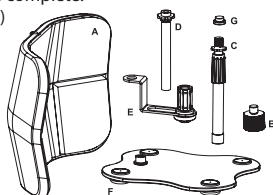

- 2) Screw the support arm for the screen (C) onto the base plate (F).

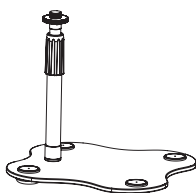

- 3) Hang the sliding assembly (E) onto the upper thread of the support arm (C) and fix it by screwing the handscrew for screen (B) onto the thread on top of the support arm (C).

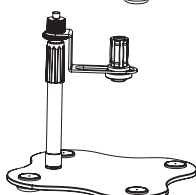

- 4) Place the microphone screen (A) onto the hand screw (B).



- 5) Remove the end cap (G) from the mic support arm (D). Then insert the support arm (D) into the sliding assembly (E).

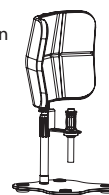

- 6) Then, screw the end cap back into the lower thread on the mic support arm (D) to hold the support arm in the sliding assembly.

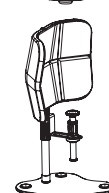

- 7) Attach the microphone holder to the upper thread of the mic support arm (D).



- 8) The microphone screen can also be mounted on a studio boom instead of on the base plate. The assembly is no different, only mic screen and microphone are then positioned inverted.

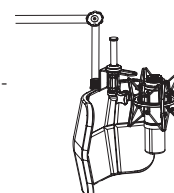

Adjustment

- 1) Loosen the handscrew of the sliding assembly (E), then move the microphone on the mic support arm (D) horizontally toward or away from the screen.
- 2) Loosen the thumbscrew on the mic support arm (D), then adjust the height of the microphone as desired. Then re-tighten the hand screw to hold the microphone in place.
- 3) Loosen the hand screw on the support arm for the screen (C), then adjust the position of the screen together with the microphone in height as desired. Then, tighten the hand screw to hold the screen and microphone in place.

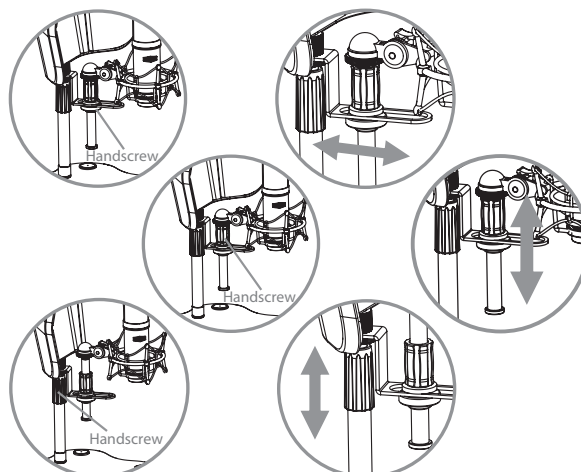

For the transport and protective packaging, environmentally friendly materials have been chosen that can be supplied to normal recycling. Ensure that plastic bags, packaging, etc. are properly disposed of. Do not just dispose of these materials with your normal household waste, but make sure that they are collected for recycling. Please follow the notes and markings on the packaging.

! The plasticiser contained in the rubber feet of this product may possibly react with the coating of your parquet, linoleum, laminate or PVC floor and after some time cause permanent dark stains. In case of doubt, do not put the rubber feet directly on the floor, but use felt-pad floor protectors or a carpet.