

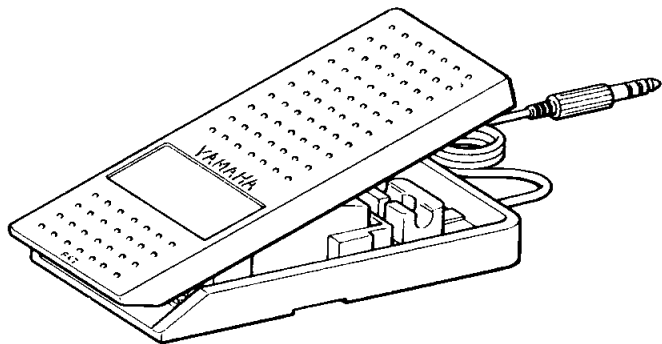

FC7

FOOT CONTROLLER

OWNER'S MANUAL



PRECAUTIONS

PLEASE READ CAREFULLY BEFORE PROCEEDING

* Please keep these precautions in a safe place for future reference.

WARNING

Always follow the basic precautions listed below to avoid the possibility of serious injury or even death from electrical shock, short-circuiting, damages, fire or other hazards. These precautions include, but are not limited to, the following:

- Do not open the instrument or attempt to disassemble the internal parts or modify them in any way. The instrument contains no user-serviceable parts. If it should appear to be malfunctioning, discontinue use immediately and have it inspected by qualified Yamaha service personnel.
- Do not expose the instrument to rain, use it near water or in damp or wet conditions.

CAUTION

Always follow the basic precautions listed below to avoid the possibility of physical injury to you or others, or damage to the instrument or other property. These precautions include, but are not limited to, the following:

- Do not expose the instrument to excessive dust or vibrations, or extreme cold or heat (such as in direct sunlight, near a heater, or in a car during the day) to prevent the possibility of panel disfiguration or damage to the internal components.
- Before moving the instrument, remove the connected cable.
- When cleaning the instrument, use a soft, dry cloth. Do not use paint thinners, solvents, cleaning fluids, or chemical-impregnated wiping cloths. Also, do not place vinyl or plastic objects on the instrument, since this might discolor the panel.
- Do not rest your weight on, or place heavy objects on the instrument, and do not use excessive force on the connectors.

Yamaha cannot be held responsible for damage caused by improper use or modifications to the instrument.

● INTRODUCTION

Thank you for purchasing the Yamaha FC7 foot controller. The FC7 uses a rotary potentiometer control, and is compatible with the older photo interpret type of pedal (FC-3A). Also, the FC7 has a fortissimo function, which enables you to accent certain parts of your performance. Also, the pedal angle is adjustable for seated or standing performance. In order to make full use of the FC7's capabilities and enjoy trouble-free operation, please read this manual carefully.

THIS DIGITAL APPARATUS DOES NOT EXCEED THE "CLASS B" LIMITS FOR RADIO NOISE EMISSIONS FROM DIGITAL APPARATUS SET OUT IN THE RADIO INTERFERENCE REGULATION OF THE CANADIAN DEPARTMENT OF COMMUNICATIONS.

LE PRESENT APPAREIL NUMERIQUE N'EMET PAS DE BRUITS RADIOELECTRIQUES DEPASSANT LES LIMITES APPLICABLES AUX APPAREILS NUMERIQUES DE LA "CLASSE B" PRESCRITES DANS LE REGLEMENT SUR LE BROUILLAGE RADIOELECTRIQUE EDICTE PAR LE MINISTERE DES COMMUNICATIONS DU CANADA.

* This applies only to products distributed by YAMAHA CANADA MUSIC LTD.

● SPECIFICATIONS

Total Pedal Angle 30°
(Both standing and seated positions)

Resistance

(K Ω)

	RT	RV
Minimum	50 \pm 30%	50 \pm 30%
Maximum	50 \pm 30%	—

Dimensions(W \times H \times D) 116 \times 58 \times 250mm

Weight 1.3kg

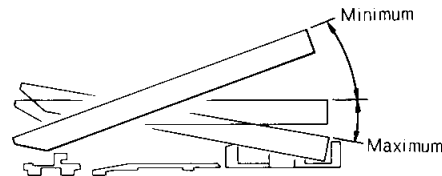
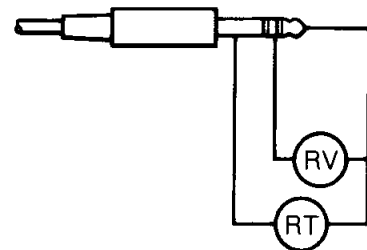

● OPERATION OF THE FC7

■ Fortissimo function

This allows you to selectively emphasise parts of your performance. As shown in the diagram, the pedal angle is 30° when fully raised. The pedal will rest at any point you take your foot off from fully raised to standard position. If you depress the pedal further from standard position, it will return to standard position when you take your foot off. Also, by adjusting the screw on the bottom, you may adjust the spring return range from 0°~10°.

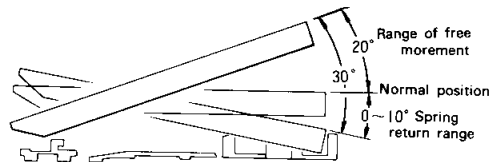

■ Selectable pedal angle

As shown below, you may change the pedal angle to fit your playing position.

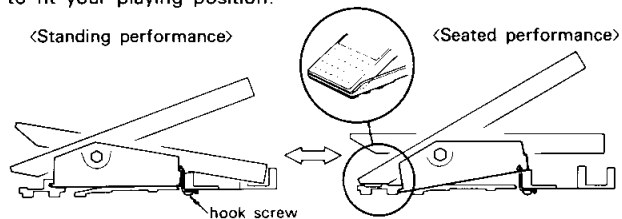

- To select pedal angle
1. Loosen hook screw with a screwdriver.
 2. Move the pedal body to the position in the illustration.
 3. Retighten the hook screw.

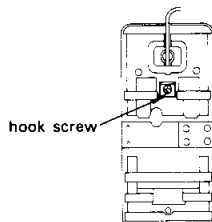

● CONNECTION OF MULTIPLE PEDALS

When using several FC7 s, you may connect them together by moving the metal plate on the bottom.

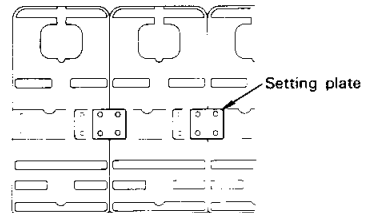

● CABLE STORAGE

Store the cable as shown.

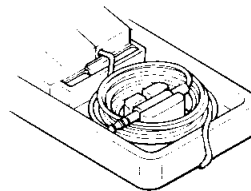

You may write the function of the pedal (eg. VOLUME, MODULATION) on a piece of tape and put it in this area.

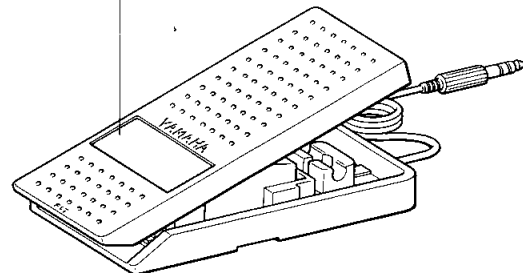



この取扱説明書は、エコパルプ（ECF：無塩素系漂白パルプ）を使用し、大豆インクで印刷しています。

This document is printed on chlorine free (ECF) paper with soy ink.

VD69020 002ITIT25.2-17P0

M.D.G., EMI Division, Yamaha Corporation
© 1999 Yamaha Corporation