



**the
t.amp**

TA 450 MK-X
TA 600 MK-X
TA 1050 MK-X
TA 1400 MK-X
TA 2400 MK-X

power amplifier

Musikhaus Thomann
Thomann GmbH
Hans-Thomann-Straße 1
96138 Burgebrach
Germany
Telephone: +49 (0) 9546 9223-0
E-mail: info@thomann.de
Internet: www.thomann.de

12.04.2019, ID: 156554, 156555, 156556, 156557, 163846 (V3)

Table of contents

1	General information	4
	1.1 Further information.....	5
	1.2 Notational conventions.....	6
	1.3 Symbols and signal words.....	6
2	Safety instructions	8
3	Features	14
4	Installation and starting up	15
5	Connections and controls	16
6	Technical specifications	21
7	Plug and connection assignment	37
8	Cleaning	41
9	Protecting the environment	42

1 General information

This user manual contains important information on the safe operation of the device. Read and follow all safety notes and all instructions. Save this manual for future reference. Make sure that it is available to all persons using this device. If you sell the device to another user, be sure that they also receive this manual.

Our products and user manuals are subject to a process of continuous development. We therefore reserve the right to make changes without notice. Please refer to the latest version of the user manual which is ready for download under www.thomann.de.

1.1 Further information

On our website (www.thomann.de) you will find lots of further information and details on the following points:

Download	This manual is also available as PDF file for you to download.
Keyword search	Use the search function in the electronic version to find the topics of interest for you quickly.
Online guides	Our online guides provide detailed information on technical basics and terms.
Personal consultation	For personal consultation please contact our technical hotline.
Service	If you have any problems with the device the customer service will gladly assist you.

1.2 Notational conventions

This manual uses the following notational conventions:

Letterings

The letterings for connectors and controls are marked by square brackets and italics.

Examples: *[VOLUME]* control, *[Mono]* button.



Cross-references

References to other locations in this manual are identified by an arrow and the specified page number. In the electronic version of the manual, you can click the cross-reference to jump to the specified location.

Example: See ↗ *'Cross-references'* on page 6.

1.3 Symbols and signal words

In this section you will find an overview of the meaning of symbols and signal words that are used in this manual.

Signal word	Meaning
DANGER!	This combination of symbol and signal word indicates an immediate dangerous situation that will result in death or serious injury if it is not avoided.
CAUTION!	This combination of symbol and signal word indicates a possible dangerous situation that can result in minor injury if it is not avoided.
NOTICE!	This combination of symbol and signal word indicates a possible dangerous situation that can result in material and environmental damage if it is not avoided.
Warning signs	Type of danger
	Warning – high-voltage.
	Warning – danger zone.

2 Safety instructions

Intended use

This device amplifies electric audio frequency signals to operate passive speakers. Use the device only as described in this user manual. Any other use or use under other operating conditions is considered to be improper and may result in personal injury or property damage. No liability will be assumed for damages resulting from improper use.

This device may be used only by persons with sufficient physical, sensorial, and intellectual abilities and having corresponding knowledge and experience. Other persons may use this device only if they are supervised or instructed by a person who is responsible for their safety.

Safety



DANGER!

Danger for children

Ensure that plastic bags, packaging, etc. are disposed of properly and are not within reach of babies and young children. Choking hazard!

Ensure that children do not detach any small parts (e.g. knobs or the like) from the unit. They could swallow the pieces and choke!

Never let children unattended use electrical devices.



DANGER!

Electric shock caused by high voltages inside

Within the device there are areas where high voltages may be present. Never remove any covers.

There are no user-serviceable parts inside.

Do not use the device if covers, protectors or optical components are missing or damaged.



DANGER!

Electric shock caused by short-circuit

Always use proper ready-made insulated mains cabling (power cord) with a protective contact plug. Do not modify the mains cable or the plug. Failure to do so could result in electric shock/death or fire. If in doubt, seek advice from a registered electrician.



CAUTION!

Possible hearing damage

The device can produce volume levels that may cause temporary or permanent hearing impairment. Over an extended period of time, even levels that seem to be uncritical can cause hearing damage.

Decrease the volume level immediately if you experience ringing in your ears or hearing impairment. If this is not possible, keep a greater distance or use sufficient ear protectors.



CAUTION!

Risk of injury due to heavy weight

Due to the heavy weight of the device, at least two persons are required for transport and installation.



NOTICE!

Risk of fire

Do not block areas of ventilation. Do not install the device near any direct heat source. Keep the device away from naked flames.



NOTICE!

Operating conditions

This device has been designed for indoor use only. To prevent damage, never expose the device to any liquid or moisture. Avoid direct sunlight, heavy dirt, and strong vibrations.



NOTICE!

Power supply

Before connecting the device, ensure that the input voltage (AC outlet) matches the voltage rating of the device and that the AC outlet is protected by a residual current circuit breaker. Failure to do so could result in damage to the device and possibly injure the user.

Unplug the device before electrical storms occur and when it is unused for long periods of time to reduce the risk of electric shock or fire.



NOTICE!

Magnetic fields

The device generates strong magnetic fields that can interfere with the function of poorly shielded devices. The strongest magnetic fields are directly above and below the power amplifier. Therefore, never place sensitive devices such as pre-amplifiers, radio transmission systems, or tape decks directly above or below the power amplifier. When installing the power amplifier into a rack, you should place it in the lowest position, and further equipment such as pre-amplifiers in the highest position.



NOTICE!

Possible damage due to installation of a wrong fuse

The use of different types of fuses can cause serious damage to the unit. Fire hazard!

Only fuses of the same type may be used.

3 Features

- Inputs
 - 2 × XLR
 - 2 × 1/4" phone socket
- Outputs
 - 2 × NL4 connectors (lockable)
 - 2 × screw terminal
- Protective circuits
 - Audio limiter
 - Thermal protection
 - Short circuit protection
 - DC voltage protection
 - Overcurrent protection
 - Infrasound protection
- Cooling via integrated two-stage fans
- Suitable for 19" racks (2 RU, mounting depth 44 cm)

Find device-specific features here ↗ *Chapter 6 'Technical specifications' on page 21.*

4 Installation and starting up

Unpack and check carefully there is no transportation damage before using the unit. Keep the equipment packaging. To fully protect the product against vibration, dust and moisture during transportation or storage use the original packaging or your own packaging material suitable for transport or storage, respectively.

Create all connections while the device is off. Use the shortest possible high-quality cables for all connections. Take care when running the cables to prevent tripping hazards.

5 Connections and controls

Front panel

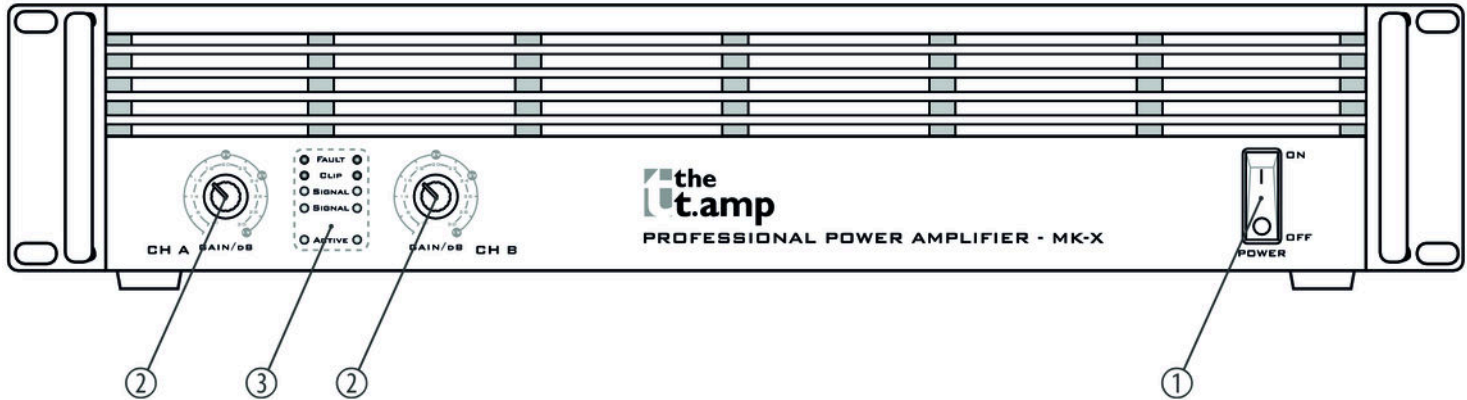

1	<i>[POWER]</i> Main switch to turn the device on and off.
2	<i>[CH-A/B]</i> Controls for input gain of channels CH-A and CH-B.
3	LED indicators for channels CH-A/B These LEDs indicate the ready status of the device (<i>[Power]</i>), the input signal level (<i>[Signal]</i>), channel overdrive (<i>[Clip]</i>) and a fault condition (<i>[Fault]</i>).



The [Power] LED is permanently lit during operation. The [Signal] LEDs respond to the input signal. If one of these LEDs is lit without an input signal being present, disconnect the loudspeakers from the power amplifier and turn the input gain control knobs of channels CH-A and CH-B to their minimum levels. If the LEDs are still permanently lit, the device must be checked by an authorized technical service centre.

Rear panel

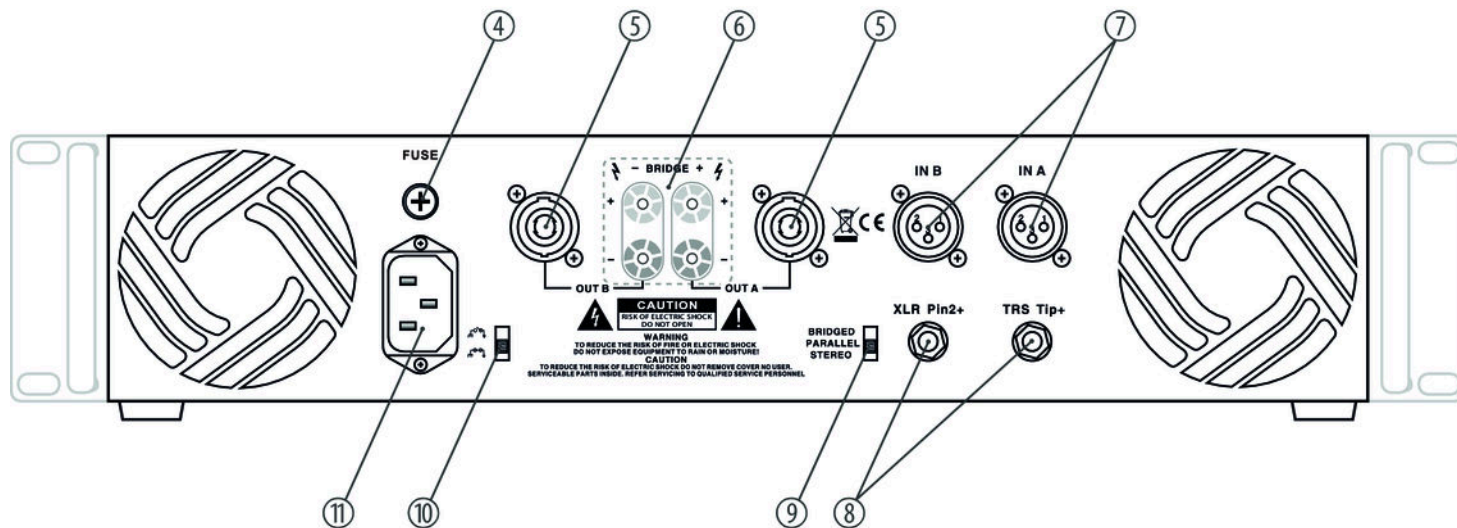

4	Fuse holder
5	<i>[OUT A OUT B]</i> Signal outputs, designed as lockable NL4 panel sockets for connecting speakers.
6	<i>[OUT A OUT B]</i> Signal outputs, designed as screw terminals (+/-) to connect speakers.
7	<i>[IN A IN B]</i> Signal inputs, designed as XLR chassis sockets.
8	<i>[IN A IN B]</i> Signal inputs, designed as 1/4" phone sockets.
9	Switch <i>[STEREO PARALLEL BRIDGED]</i> Switch for operating modes 'STEREO' (channels operate independently of each other), 'PARALLEL' (two channels are interconnected) and 'BRIDGED' (two channels are interconnected to form one channel with double output).

10 *[Lift | Ground]* selector switch

The Ground/Lift switch allows you to interrupt the connection between the device's protective earth terminal and signal ground in order to prevent hum loops (Lift/unpressed state: disconnected. 'Ground' position / switch pressed: Earth pin and signal ground are electrically connected).

11 IEC chassis plug for the power supply.

6 Technical specifications

TA 450 MK-X

Amplifier class	H	
Input impedance	20 k Ω (balanced) 10 k Ω (unbalanced)	
Output power	RMS 8 Ω , stereo	2 \times 160 W
	RMS 4 Ω , stereo	2 \times 250 W
	RMS 8 Ω , mono bridged	490 W
Slew rate	40 V/ μ s	
Common mode rejection	> 60 dB (1 kHz)	
IMD-SMPTE (60 Hz, 7 kHz)	< 0.01 % / 160 W	
Crosstalk	< 60 dB	
Frequency response	20 Hz ... 20 kHz (+ 0.1 ... - 3 dB, 1 W, 8 Ω)	

TA 450 MK-X TA 600 MK-X TA 1050 MK-X TA 1400 MK-X TA 2400 MK-X

Technical specifications

Signal-to-noise ratio	103 dB			
Total harmonic distortion (THD) 4 Ω at 1 kHz	< 0.05 % / 250 W			
Damping factor (8 Ω , 1 kHz)	300:1			
Sensitivity	0,775 V at rated power (8 Ω)			
Gain	34 dB			
Cooling	2 \times 2-speed DC fan			
Power consumption	Load	1/8 nominal power	1/3 nominal power	1/1 nominal power
	(2 \times) 8 Ω	213 W / 1,4 A	336 W / 2,1 A	565 W / 3,3 A
	(2 \times) 4 Ω	338 W / 2,1 A	540 W / 3,2 A	890 W / 4,9 A
Supply voltage	230 V \sim 50 Hz			
Fuse	5 mm \times 20 mm, 8 A, 250 V, fast blow			
Dimensions (W \times H \times D)	483 mm \times 103 mm \times 475 mm			
Weight	13.3 kg			

Ambient conditions	Temperature range	0 °C...40 °C
	Relative humidity	50 %, non-condensing

TA 450 MK-X TA 600 MK-X TA 1050 MK-X TA 1400 MK-X TA 2400 MK-X

TA 600 MK-X

Amplifier class	H	
Input impedance	20 k Ω (balanced) 10 k Ω (unbalanced)	
Output power	RMS 8 Ω , stereo	2 \times 220 W
	RMS 4 Ω , stereo	2 \times 330 W
	RMS 8 Ω , mono bridged	640 W
Slew rate	40 V/ μ s	
Common mode rejection	> 60 dB (1 kHz)	
IMD-SMPTE (60 Hz, 7 kHz)	< 0.01 % / 220 W	
Crosstalk	< 60 dB	
Frequency response	20 Hz ... 20 kHz (+ 0.1 ... - 3 dB, 1 W, 8 Ω)	
Signal-to-noise ratio	103 dB	

Total harmonic distortion (THD) 4 Ω at 1 kHz	< 0.05 % / 330 W			
Damping factor (8 Ω, 1 kHz)	300:1			
Sensitivity	0,775 V at rated power (8 Ω)			
Gain	34 dB			
Cooling	2 × 2-speed DC fan			
Power consumption	Load	1/8 nominal power	1/3 nominal power	1/1 nominal power
	(2 ×) 8 Ω	250 W / 1,6 A	375 W / 2,3 A	650 W / 3,7 A
	(2 ×) 4 Ω	405 W / 2,5 A	650 W / 3,7 A	1075 W / 5,8 A
Supply voltage	230 V ~ 50 Hz			
Fuse	5 mm × 20 mm, 10 A, 250 V, fast blow			
Dimensions (W × H × D)	485 mm × 103 mm × 470 mm			
Weight	13.7 kg			

TA 450 MK-X TA 600 MK-X TA 1050 MK-X TA 1400 MK-X TA 2400 MK-X

Technical specifications

Ambient conditions	Temperature range	0 °C...40 °C
	Relative humidity	50 %, non-condensing

TA 1050 MK-X

Amplifier class	H	
Input impedance	20 k Ω (balanced) 10 k Ω (unbalanced)	
Output power	RMS 8 Ω , stereo	2 \times 400 W
	RMS 4 Ω , stereo	2 \times 620 W
	RMS 8 Ω , mono bridged	1200 W
Slew rate	40 V/ μ s	
Common mode rejection	> 60 dB (1 kHz)	
IMD-SMPTE (60 Hz, 7 kHz)	< 0.01 % / 400 W	
Crosstalk	< 60 dB	
Frequency response	20 Hz ... 20 kHz (+ 0.1 ... - 3 dB, 1 W, 8 Ω)	
Signal-to-noise ratio	103 dB	

TA 450 MK-X TA 600 MK-X TA 1050 MK-X TA 1400 MK-X TA 2400 MK-X

Technical specifications

Total harmonic distortion (THD) 4 Ω at 1 kHz	< 0.05 % / 620 W			
Damping factor (8 Ω , 1 kHz)	300:1			
Sensitivity	0,775 V at rated power (8 Ω)			
Gain	34 dB			
Cooling	2 \times 2-speed DC fan			
Power consumption	Load	1/8 nominal power	1/3 nominal power	1/1 nominal power
	(2 \times) 8 Ω	450 W / 2,9 A	690 W / 4,2 A	1190 W / 6,8 A
	(2 \times) 4 Ω	735 W / 4,4 A	1150 W / 6,6 A	1980 W / 10,6 A
Supply voltage	230 V \sim 50 Hz			
Fuse	5 mm \times 20 mm, 15 A, 250 V, fast blow			
Dimensions (W \times H \times D)	483 mm \times 103 mm \times 475 mm			
Weight	16.4 kg			

Ambient conditions	Temperature range	0 °C...40 °C
	Relative humidity	50 %, non-condensing

TA 450 MK-X TA 600 MK-X TA 1050 MK-X TA 1400 MK-X TA 2400 MK-X

TA 1400 MK-X

Amplifier class	H	
Input impedance	20 k Ω (balanced) 10 k Ω (unbalanced)	
Output power	RMS 8 Ω , stereo	2 \times 570 W
	RMS 4 Ω , stereo	2 \times 850 W
	RMS 8 Ω , mono bridged	1600 W
Slew rate	40 V/ μ s	
Common mode rejection	> 60 dB (1 kHz)	
IMD-SMPTE (60 Hz, 7 kHz)	< 0.01 % / 570 W	
Crosstalk	< 60 dB	
Frequency response	20 Hz ... 20 kHz (+ 0.1 ... - 3 dB, 1 W, 8 Ω)	
Signal-to-noise ratio	103 dB	

Total harmonic distortion (THD) 4 Ω at 1 kHz	< 0.05 % / 850 W			
Damping factor (8 Ω, 1 kHz)	350:1			
Sensitivity	0,775 V at rated power (8 Ω)			
Gain	36.9 dB			
Cooling	2 × 2-speed DC fan			
Power consumption	Load	1/8 nominal power	1/3 nominal power	1/1 nominal power
	(2 ×) 8 Ω	380 W / 2,4 A	985 W / 5,8 A	1650 W / 9,3 A
	(2 ×) 4 Ω	665 W / 3,9 A	1730 W / 9,9 A	2650 W / 14,0 A
Supply voltage	230 V ~ 50 Hz			
Fuse	5 mm × 20 mm, 15 A, 250 V, fast blow			
Dimensions (W × H × D)	483 mm × 103 mm × 475 mm			
Weight	17.5 kg			

TA 450 MK-X TA 600 MK-X TA 1050 MK-X TA 1400 MK-X TA 2400 MK-X

Technical specifications

Ambient conditions	Temperature range	0 °C...40 °C
	Relative humidity	50 %, non-condensing

TA 2400 MK-X

Amplifier class	H	
Input impedance	20 k Ω (balanced) 10 k Ω (unbalanced)	
Output power	RMS 8 Ω , stereo	2 \times 760 W
	RMS 4 Ω , stereo	2 \times 1200 W
	RMS 8 Ω , mono bridged	2300 W
Slew rate	60 V/ μ s	
Common mode rejection	> 60 dB (1 kHz)	
IMD-SMPTE (60 Hz, 7 kHz)	< 0.01 % / 760 W	
Crosstalk	< 60 dB	
Frequency response	20 Hz ... 20 kHz (+ 0.1 ... - 3 dB, 1 W, 8 Ω)	
Signal-to-noise ratio	103 dB	

Technical specifications

Total harmonic distortion (THD) 4 Ω at 1 kHz	< 0.05 % / 1200 W			
Damping factor (8 Ω, 1 kHz)	500:1			
Sensitivity	0,775 V at rated power (8 Ω)			
Gain	39.2 dB			
Cooling	2 × 2-speed DC fan			
Power consumption	Load	1/8 nominal power	1/3 nominal power	1/1 nominal power
	(2 ×) 8 Ω	443 W / 2,8 A	1080 W / 6,6 A	2180 W / 12,2 A
	(2 ×) 4 Ω	790 W / 4,8 A	2004 W / 10,3 A	3600 W / 18,9 A
Supply voltage	230 V ~ 50 Hz			
Fuse	5 mm × 20 mm, 20 A, 250 V, fast blow			
Dimensions (W × H × D)	483 mm × 103 mm × 475 mm			
Weight	19.7 kg			

Ambient conditions	Temperature range	0 °C...40 °C
	Relative humidity	50 %, non-condensing

Further information

Channels	2
suitable for 19" racks	2 RU
2 Ω stability	No
DSP / frequency	No
Convection cooling	No
Protection circuits (DC voltage protection, overtemperature protection, short-circuit protection, infrasound protection, overcurrent protection)	Yes

Block diagram

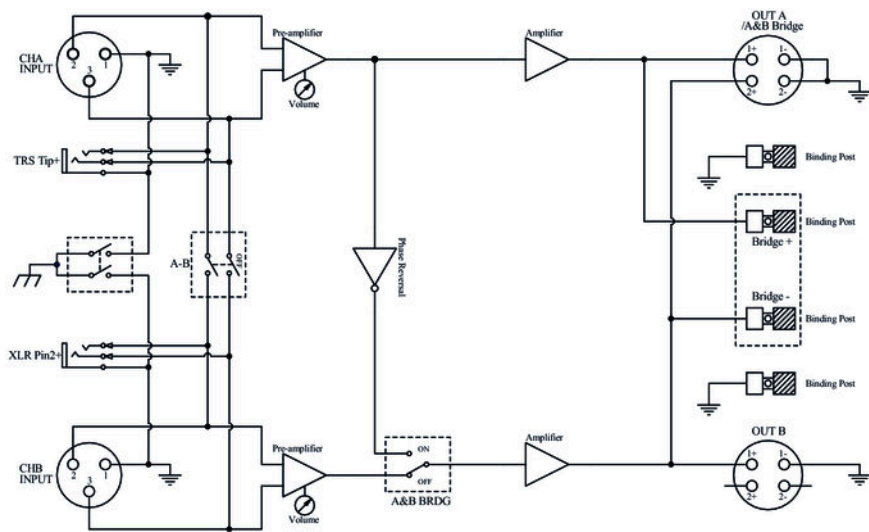

7 Plug and connection assignment

Introduction

This chapter will help you select the right cables and plugs to connect your valuable equipment in such a way that a perfect sound experience is ensured.

Please note these advices, because especially in 'Sound & Light' caution is indicated: Even if a plug fits into the socket, an incorrect connection may result in a destroyed power amp, a short circuit or 'just' in poor transmission quality!

Balanced and unbalanced transmission

Unbalanced transmission is mainly used in semi-professional environment and in hifi use. Instrument cables with two conductors (one core plus shielding) are typical representatives of the unbalanced transmission. One conductor is ground and shielding while the signal is transmitted through the core.

Unbalanced transmission is susceptible to electromagnetic interference, especially at low levels, such as microphone signals and when using long cables.

In a professional environment, therefore, the balanced transmission is preferred, because this enables an undisturbed transmission of signals over long distances. In addition to the conductors 'Ground' and 'Signal', in a balanced transmission a second core is added. This also transfers the signal, but phase-shifted by 180°.

Since the interference affects both cores equally, by subtracting the phase-shifted signals, the interfering signal is completely neutralized. The result is a pure signal without any noise interference.

1/4" TS phone plug (mono, unbalanced)



1	Signal
2	Ground, shielding

1/4" TRS phone plug (mono, balanced)



1	Signal (in phase, +)
2	Signal (out of phase, -)
3	Ground

1/4" TRS phone plug (stereo, unbalanced)



1	Signal (left)
2	Signal (right)
3	Ground

XLR plug (balanced)

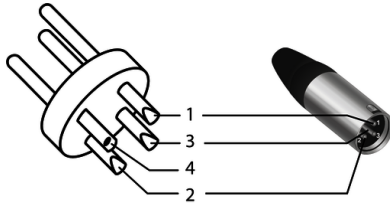

1	Ground, shielding
2	Signal (in phase, +)
3	Signal (out of phase, -)
4	Shielding on plug housing (option)

XLR plug (unbalanced)

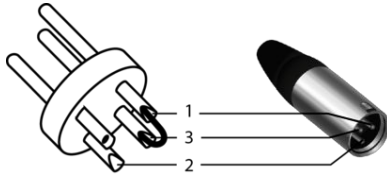

1	Ground, shielding
2	Signal
3	Bridged to pin 1

Speaker Twist chassis connector

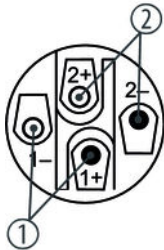

1, +	Signal 1 (in phase)
1, -	Signal 1 (out of phase)
2, +	Signal 2 (in phase)
2, -	Signal 2 (out of phase)

8 Cleaning

Fan grids

The fan grids of the device must be cleaned of any contamination, such as dust, etc. on a regular basis. Before cleaning, switch off the device and disconnect mains-operated devices from the mains. Only use pH-neutral, solvent-free and non-abrasive cleaning agents. Clean the unit with a slightly damp lint-free cloth.

9 Protecting the environment

Disposal of the packaging material



For the transport and protective packaging, environmentally friendly materials have been chosen that can be supplied to normal recycling.

Ensure that plastic bags, packaging, etc. are properly disposed of.

Do not just dispose of these materials with your normal household waste, but make sure that they are collected for recycling. Please follow the notes and markings on the packaging.

Disposal of your old device



This product is subject to the European Waste Electrical and Electronic Equipment Directive (WEEE) in its currently valid version. Do not dispose with your normal household waste.

Dispose of this device through an approved waste disposal firm or through your local waste facility. When discarding the device, comply with the rules and regulations that apply in your country. If in doubt, consult your local waste disposal facility.



