



DM-2512

DMX manager

Musikhaus Thomann
Thomann GmbH
Hans-Thomann-Straße 1
96138 Burgebrach
Germany
Telephone: +49 (0) 9546 9223-0
E-mail: info@thomann.de
Internet: www.thomann.de

31.10.2018, ID: 172666

Table of contents

1	General information	6
	1.1 Further information.....	7
	1.2 Notational conventions.....	8
	1.3 Symbols and signal words.....	9
2	Safety instructions	11
	2.1 Safety instructions.....	11
3	Features	15
4	Installation and starting up	16
5	Connections and controls	19
6	Operating	23
	6.1 Setting the operating modes.....	23
	6.2 Setting the DMX address.....	25
7	Technical specifications	27
8	Plug and connection assignments	28

9	Protecting the environment.....	29
----------	--	-----------



1 General information

This manual contains important instructions for the safe operation of the unit. Read and follow the safety instructions and all other instructions. Keep the manual for future reference. Make sure that it is available to all those using the device. If you sell the unit please make sure that the buyer also receives this manual.

Our products are subject to a process of continuous development. Thus, they are subject to change.

1.1 Further information

On our website (www.thomann.de) you will find lots of further information and details on the following points:

Download	This manual is also available as PDF file for you to download.
Keyword search	Use the search function in the electronic version to find the topics of interest for you quickly.
Online guides	Our online guides provide detailed information on technical basics and terms.
Personal consultation	For personal consultation please contact our technical hotline.
Service	If you have any problems with the device the customer service will gladly assist you.

1.2 Notational conventions

This manual uses the following notational conventions:

Letterings



The letterings for connectors and controls are marked by square brackets and italics.

Examples: *[VOLUME]* control, *[Mono]* button.

Instructions

The individual steps of an instruction are numbered consecutively. The result of a step is indented and highlighted by an arrow.

Example:

1.  Switch on the device.
2.  Press *[Auto]*.
 - ⇒ Automatic operation is started.
3.  Switch off the device.

1.3 Symbols and signal words

In this section you will find an overview of the meaning of symbols and signal words that are used in this manual.

Signal word	Meaning
DANGER!	This combination of symbol and signal word indicates an immediate dangerous situation that will result in death or serious injury if it is not avoided.
NOTICE!	This combination of symbol and signal word indicates a possible dangerous situation that can result in material and environmental damage if it is not avoided.
Warning signs	Type of danger
	Warning – high-voltage.

Warning signs	Type of danger
	Warning – danger zone.

2 Safety instructions

2.1 Safety instructions

Intended use

This device is intended for merging multiple DMX signals, for distributing one DMX signal to multiple DMX chains and for the extension of a DMX chain. Use the device only as described in this user manual. Any other use or use under other operating conditions is considered to be improper and may result in personal injury or property damage. No liability will be assumed for damages resulting from improper use.

This device may be used only by persons with sufficient physical, sensorial, and intellectual abilities and having corresponding knowledge and experience. Other persons may use this device only if they are supervised or instructed by a person who is responsible for their safety.

Safety



DANGER!

Danger for children

Ensure that plastic bags, packaging, etc. are disposed of properly and are not within reach of babies and young children. Choking hazard!

Ensure that children do not detach any small parts (e.g. knobs or the like) from the unit. They could swallow the pieces and choke!

Never let children unattended use electrical devices.



DANGER!

Electric shock caused by high voltages inside

Within the device there are areas where high voltages may be present. Never remove any covers.

There are no user-serviceable parts inside.

Do not use the device if covers, protectors or optical components are missing or damaged.



NOTICE!

Risk of fire

Do not block areas of ventilation. Do not install the device near any direct heat source. Keep the device away from naked flames.



NOTICE!

Operating conditions

This device has been designed for indoor use only. To prevent damage, never expose the device to any liquid or moisture. Avoid direct sunlight, heavy dirt, and strong vibrations.



NOTICE!

External power supply

The device is powered by an external power supply. Before connecting the external power supply, ensure that the input voltage (AC outlet) matches the voltage rating of the device and that the AC outlet is protected by a residual current circuit breaker. Failure to do so could result in damage to the device and possibly the user.

Unplug the external power supply before electrical storms occur and when the device is unused for long periods of time to reduce the risk of electric shock or fire.

3 Features

DMX manager with the following features:

- Three operating modes: HTP, Backup and Merge
- 2 × 3-pin DMX input on the front panel, 2 × 3-pin DMX input on the rear panel (not usable in parallel)
- 1 × 3-pin DMX output on the front panel, 1 × 3-pin DMX output on the rear panel (not usable in parallel)
- 19" rack-mountable

4 Installation and starting up

Unpack and check carefully there is no transportation damage before using the unit. Keep the equipment packaging. To fully protect the product against vibration, dust and moisture during transportation or storage use the original packaging or your own packaging material suitable for transport or storage, respectively.

Create all connections while the device is off. Use the shortest possible high-quality cables for all connections. Take care when running the cables to prevent tripping hazards.



NOTICE!

Possible data transmission errors

For error-free operation make use of dedicated DMX cables and do not use ordinary microphone cables.

Never connect the DMX input or output to audio devices such as mixers or amplifiers.

Connections in 'DMX' mode

Connect the output of the first DMX device to the input of the second one and so on, to form a series connection. Connect the output of this DMX chain to input A on the front or back of the DMX Manager. Connect the output of a second DMX chain to input B on the front or back of the DMX Manager. Connect the output on the front or rear of the DMX Manager to the DMX input of a DMX controller or other DMX device. Make sure that the output of the last DMX device in the chain is terminated by a resistor (110 Ω , 1/4 W). Note that the ports on the front and back can not be used in parallel.

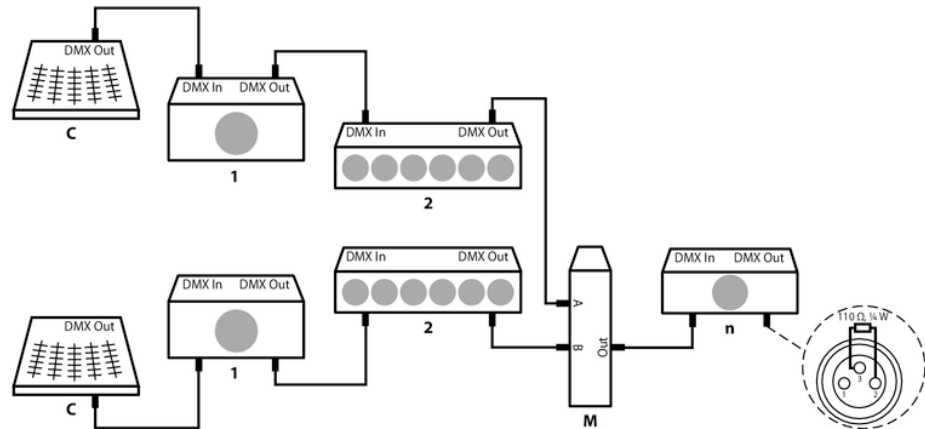

DMX indicator

When the device and the DMX controller are operational, the DMX indicator in the display shows that a DMX signal is being received on the input.

Rack mounting

The unit has been designed for rack mounting in a standard 19" rack; it occupies one rack unit.

5 Connections and controls

Front panel

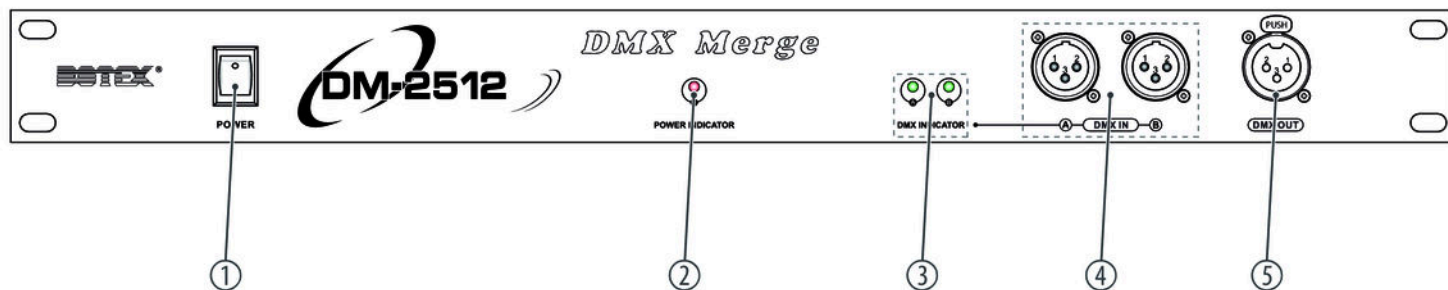

1	<i>[POWER]</i> Main switch. Turns the device on and off.
2	<i>[POWER INDICATOR]</i> Indicator LED for operating status. Lights up once the device is turned on.
3	<i>[DMX INDICATOR] [A], [B]</i> 2 × indicator LED for DMX input. The indicator LED of the respective channel lights up green as soon as a signal is present.
4	<i>[DMX IN]</i> 2 × DMX input, designed as XLR socket
5	<i>[DMX OUT]</i> 1 × DMX output, designed as XLR socket

Rear panel

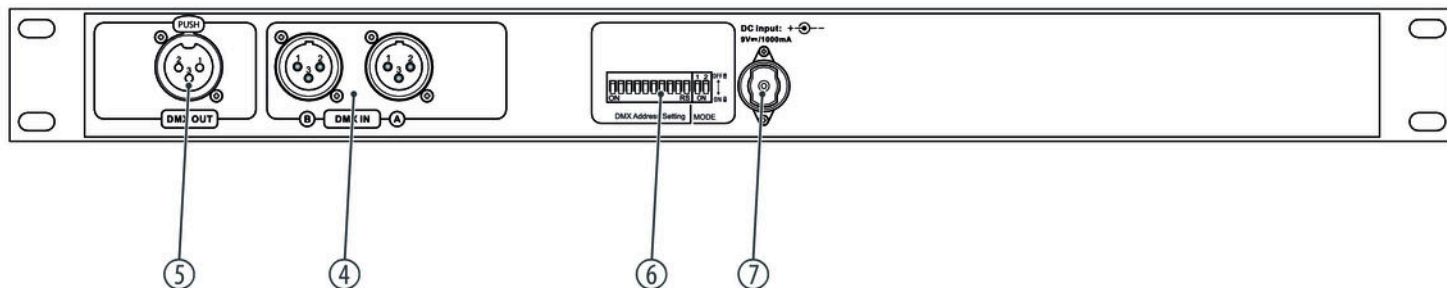

4	<i>[DMX IN]</i> 2 × DMX input, designed as XLR socket
5	<i>[DMX OUT]</i> 1 × DMX output, designed as XLR socket
6	DIP switches for setting the operating modes and DMX addresses
7	Connection for the plug-in power supply.

6 Operating

6.1 Setting the operating modes

The device offers three different operating modes for combining several DMX signals: HTP, Backup and Merge.

Operating mode HTP (High Take Precedence Modus)

In HTP mode, the highest DMX value has priority.

➔ Set DIP switches 1 and 2 to *[OFF]*.

⇒ The HTP mode is activated. If two DMX signals are present at the inputs of the device, then the signal with the higher value overwrites the other signal.

Operating mode BACKUP

In BACKUP mode, the signal of the other input is accepted if no DMX signal is present at one input.

- Set DIP switch 1 to *[ON]* and switch 2 to *[OFF]*.
 - ⇒ The BACKUP mode is activated. If a DMX signal is present at input A, it is output at the device output. If no DMX signal is present at input A, then the signal from input B is output at the device output.

Operating mode MERGE

In MERGE mode, the DMX signals A and B are combined to form a new signal.

- 1.** ➤ Set DIP switch 1 to *[OFF]* and switch 2 to *[ON]*.
 - ⇒ The MERGE mode is activated.
- 2.** ➤ Use the DIP switches 1 ... 9 to set the DMX start address for the merged new signal.

Example: You want to merge the first 6 channels of DMX signal A and all subsequent channels of DMX signal B.

- 1.** ➤ Set DIP switches 1, 2 and 3 to *[ON]*.
- 2.** ➤ Set DIP switches 4 ... 10 to *[OFF]*.
 - ⇒ The first 6 channels of the DMX output signal are occupied by the 6 channels of the DMX signal A. The channels 7 ... 512 of the DMX output signal are occupied by the channels of the DMX signal B.

6.2 Setting the DMX address

DMX address table

DMX B Start channel number	Dip switch ON
1	1
2	2
3	1, 2
4	3
5	1, 3
6	2, 3
7	1, 2, 3
8	4
9	1, 4
10	2, 4

DMX B Start channel number	Dip switch ON
11	1, 2, 4
12	3, 4
13	1, 3, 4
14	2, 3, 4
15	1, 2, 3, 4
16	5
...	...
511	1, 2, 3, 4, 5, 6, 7, 8, 9

7 Technical specifications

Voltage supply	Plug-in power supply (9 V $\overline{\text{---}}$ / 1000 mA , centre positive)
Dimensions (W \times H \times D)	482 mm \times 44 mm \times 162 mm
Weight	2.0 kg

8 Plug and connection assignments

Introduction

This chapter will help you select the right cables and plugs to connect your valuable equipment so that a perfect light experience is guaranteed.

Please take our tips, because especially in 'Sound & Light' caution is indicated: Even if a plug fits into a socket, the result of an incorrect connection may be a destroyed DMX controller, a short circuit or 'just' a not working light show!

DMX connections

The unit offers a 3-pin XLR socket for DMX output and a 3-pin XLR plug for DMX input. Please refer to the drawing and table below for the pin assignment of a suitable XLR plug.



Pin	Configuration
1	Ground, shielding
2	Signal inverted (DMX-, 'cold signal')
3	Signal (DMX+, 'hot signal')

9 Protecting the environment

Disposal of the packaging material



For the transport and protective packaging, environmentally friendly materials have been chosen that can be supplied to normal recycling.

Ensure that plastic bags, packaging, etc. are properly disposed of.

Do not just dispose of these materials with your normal household waste, but make sure that they are collected for recycling. Please follow the notes and markings on the packaging.

Disposal of your old device



This product is subject to the European Waste Electrical and Electronic Equipment Directive (WEEE) in its currently valid version. Do not dispose with your normal household waste.

Dispose of this device through an approved waste disposal firm or through your local waste facility. When discarding the device, comply with the rules and regulations that apply in your country. If in doubt, consult your local waste disposal facility.

