



DR.DMX III

PROFESSIONAL RDM TESTER



User's Instruction

General Index

General Information

Description.....	Page4
Unpacking.....	Page4
Safety Instructions.....	Page4
Specifications.....	Page4
General Instructions.....	Page5
Physical Diagram.....	Page5

Operation Guide

Main Menus.....	Page6
DMX Packet.....	Page7
1. Data Format	
2. Data Timing	
3. Data Level	
DMX Data RX.....	Page9
1. Barchart display	
2. Value display	
3. Min/Max display	
DMX Data TX.....	Page12
1. 512 channel	
2. Single channel	
3. Cue/Memory	
4. Run Cues(Scenes)	
RDM Control.....	Page15
1. DISC_COMMAND	
2. GET or SET COMMAND	
DMX 1000K Mode.....	Page21
1. DMX-1000K RX	
2. DMX-1000K TX	
3. TX Single Chanl	
Moving Light.....	Page23
1. Library Setting	
2. Play mode	
Save Cue(Scene).....	Page24
Cable Test.....	Page25
MIDI Data-RX.....	Page26
System Setup.....	Page26
1. DMX Setting	
2. English	
3. Display Setting	

Software Updating

.....	Page28
-------	--------

General Information

Description

Thank you for your purchase of the Dr.DMXIII !

The Dr.DMXIII is a professional RDM tester with the features of stylish design and versatility . Ten mainly menus are available for user adopt .With it's flexible dial wheel, the user may use it to access all the menus and do the tests DMX packet and cable concerned , identify whether any errors occurring on your console or dimmers. It's 4x20 characters LCD displays the menu states and the received DMX data which makes the operation interface is very friendly. Prior to use your new product, please read this user's instruction carefully and keep it well for the possible future reference.

Unpacking

This unit has been thoroughly tested and carefully packed. For some unexpected reasons, check it carefully to be sure that your product is not damaged and all accessories are not missing. If your product happens to be damaged or missing, please do not use it. Contact the local dealer or distributor without hesitation.

Safety Instructions

Reduce the risk of electric shock or fire when using this unit.
Do not immerse in or expose to water.
Turn off this unit, if not being used for a long time.
Do not use immediately in the event of malfunction.
Do not dismantle or modify the unit, only by qualified staff.

Specifications

Model No:	Dr.DMXIII
Power Input:	9V DC , 500mA (an AC ~ DC adaptor included or built-in rechargeable battery)
DMX In :	3 and 5 pins male XLR connectors
DMX Out :	3 and 5 pins female XLR connectors
MIDI In:	5 pins male XLR socket
Dimensions:	207.5x208x75 mm
Weight:	0.6 kg

All rights reserved. No part of this manual may be reproduced in any form or by any means without written permission.

General Instructions

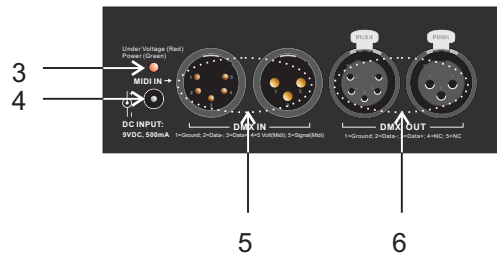

1. **LCD** : Displays the functions and guides you to operate the unit.
2. **Dial Wheel** : Used to operate this device.
3. **Power Indicator** : It will light red when the unit is in the state of "under voltage". It will light green when the unit was supplied with the full power source .
4. **DC INPUT**: Connects to the power of 9V DC, 500mA .
5. **DMX/MIDI IN**: Used to input DMX signal via 5-pin or 3-pin connector. To input MIDI via 5-pin connector.
6. **DMX OUT** : Outputs DMX signal via 5-pin or 3-pin connector.

Physical Diagram

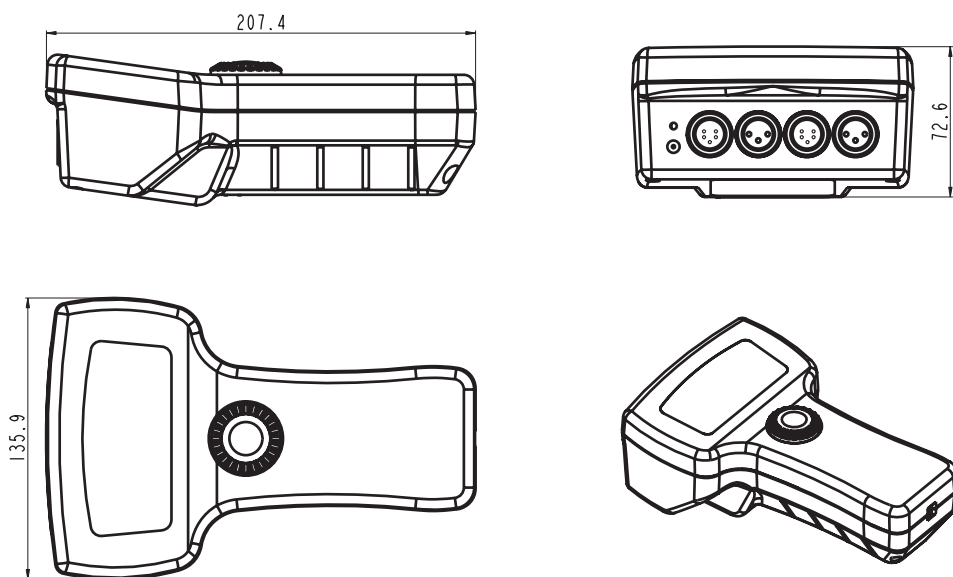

Operation Guide

Main Menus

Dr.DMXIII, which can be applied in various lighting occasions to meet your requirements, provides ample menu options in 20 x 4 LCD window for you. The desired menu or window can be activated by turning the Dial wheel, and by pressing this Dial wheel in the central place will access to the menu functions.

NOTE: If you want to browse the next forward menu, please turn the Dial wheel right. On the contrary, you may turn it left to browse the previous menu option.

The power of this unit can be supplied by built-in storage battery or DC 9V adaptor. When using DC 9V adaptor for this unit, the built-in battery will automatically be charged at the same time. To increase the charging speed, do not switch on this unit. The time for full charging battery is about 3~5 hours, which can supply the unit for 6~8 hours. When switching the unit on at first, with its switch at back cover, the LCD window shows main window information as follows:

```

≤ ==== BOTEX ====
  Dr.DMX-III RDM TESTER
    REV1.00
  ( C ) NCW 2009  >
  
```

Pressing the dial wheel will access the top window.

```

≤ DMX Packet test  >
  DMX data--RX    >
  DMX data--TX    >
↓ RDM Control     >
  
```

There are 10 main menu options for your choice, including **DMX packet test**, **DMX dataRX**, **DMX dataTX**, **RDM Control**, **DMX 1000K Mode**, **Moving light**, **Save Cue**, **Cable test**, **MIDI data RX** and **System setup**.

```

≤ DMX 1000K mode  >
  Moving Light    >
  Save Cue(Scene) >
↓ Cable Test     >
  
```

```

↑ MIDI data-RX    >
  System Setup    >
  
```

DMX packet test

Turn the Dial wheel right to select **DMX packet test** and then press the Dial wheel to access this function.

```

≤ DMX packet test:
 1. Data format   >
 2. Data timing   >
 3. Data level ( Volt ) >

```

If there is no signal input and you have accessed each menu of Data format, Data timing, Data level (Volt) by the Dial wheel, the LCD window shows the same as follows:

```

≤ DMX packet test:

Receive no signal ?

```

You may locate the cursor to the label ? for help. In this case, the help message usually shows:

```

≤ DMX-512 tester help
No signal or signal
not complying with
USITT DMX-512( 1990 )

```

On the contrary, if there is signal input, you can do some DMX packet tests .

1. Data format

Turn the Dial wheel to select **Data format** and press it for viewing the total channels of external operator and the states of BREAK when receiving the signals.

The LCD window shows the channel information of external connected DMX operator.
(For example, here the external connected DMX operator is DC-1216II from us .)

```

≤ Data format:   ?
RX-Chan: 192
Break:--OK--
Signal present

```

Means the total channels of DC-1216II

For the further information, you may use the help function by pressing Dial wheel. The help information shows as below.

```

≤ Data format:
  Indication of --OK--
  means:Received
  signal is good
    
```

To return to the previous menu, press the ≤ by Dial wheel.

2. Data timing

Turn the Dial wheel to select **Data timing** and press it for application. You can view all the parameters of the received signals, including BREAK, MaB, START CODE, CHAN TIME, Period Time. The LCD window will dynamically show data timing information.
 (Here the external connected DMX operator is also DC-1216II.)

```

≤ Data timing:   ?
  BK: 135us MaB:016 uS
  StartCode: 000 dec
  Chan Time:053 us
    
```

All the parameters can be shown here.

Select > first and then press it can shift from Chan, Time to Period Time. In this case, the fourth line of the LCD window shows the message " Period : 036 ms ".

For the further information, you may use the help function by pressing Dial wheel. The help information shows as below.

```

≤ Data timing:
  Break      min.88us
  MaB        min. 8 us
  Chantime   min. 44us
    
```

3. Data level (Volt)

Turn the Dial wheel to select **Data level (Volt)** and press it in the central place for application.

The LCD window will dynamically shows the information of signal voltage .
 (Here the external connected DMX operator is also DC-1216II.)

```

≤ Data Level(Volt) ?
  --Good-->
  ██████████...
  Level = 4.44V
    
```

For the further information, you may use the help function by pressing Dial wheel. The help information shows as below.

≤ Data level
 Reception may still
 be possible with
 lower level

For another menu available, you may turn the Dial wheel backward to return. Then select the new entry by Dial wheel.

DMX data -- RX

Turn the Dial wheel to select **DMX data--RX** and then press the Dial wheel access this menu function. There are 3 sub-menu options, including **Barchart display, Value display and Min/max display.**

≤ DMX data RX
 1. Barchart display >
 2. Value display >
 3. Min/ max display >

This DMX data--RX function can display the value of signal input by the means of Barchart and Value and Min/max, complying with the display mode that can be adjusted in the System setup menu. There are two display modes: Normal and Hold Mode.

In the **Normal** display mode, when pushing the fader relative to the specific channel of external operator (e.g. DC-1216II), the relative channel value of the LCD window will change temporarily, conforming with the position of fader.

In the **Hold** display mode, when pushing the fader relative to the specific channel of external operator (e.g. DC-1216II), the relative channel value of the LCD window may not change temporarily. The display value is only the max. value of all the adjustment by the fader.

1. Barchart display

Turn the Dial wheel forward to enter the Barchart display option. If there is no signal input, the LCD window always show empty information as follows:

≤ RX Channel :000 ?
 001: xxxxx xxxxx
 011: xxxxx xxxxx
 021: xxxxx xxxxx

Total channels of received
 signal:000

Means: no signal input from
 channel 1 to channel 10

Each line can indicate the values of 10 channels in all. To browse the other values of channels, turn the Dial wheel forward to select >, then press the Dial wheel. At this time you can turn Dial wheel backward or forward for this purpose.

On the contrary, if there is signal input, the LCD window will display the values of received signals in the bar chart diagram.(e.g. DC-1216II)

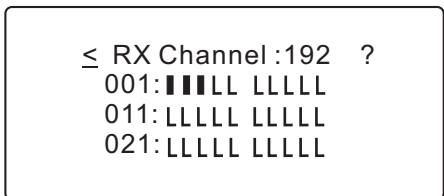

For the further information, you may use the help function by pressing Dial wheel. The help information shows as below.

Each bar chart indicates the different value of the fader.

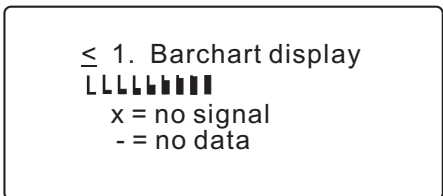

2. Value display

This option can display the value of signal input by the means of decimal, hexadecimal and percent. Turn the Dial wheel forward to enter the Barchart display option. If there is no signal input, the LCD window always show empty information as follows:

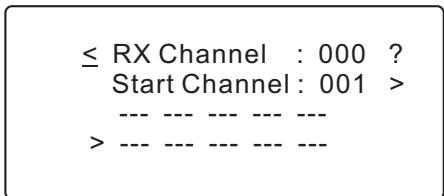

The default total channels is set to be 000 and the start channel always is automatically preset to be 001. If you would like to change the start channel, turn the Dial wheel to select > at the right side of the LCD window. You can scroll to the desired channel No., then press the Dial wheel again to confirm.

On the contrary, if there is signal input, the LCD window will display the values of received signals in the following diagram. For example(e.g. DC-1216II).



For decimal, hexadecimal or percent display mode, you can turn the Dial wheel to select > at the left side of the LCD window. And then press the Dial wheel to scroll to the desired mode. The display values of the relative channels will temporarily be changed according to the new setting.

NOTE: Other main display values of this unit may be converted, complying with the new display mode.

For the further information, you may use the help function by pressing Dial wheel. The help information shows as below.

≤ 2. Value display
 Display ten number
 in decimal, hexadecimal or percent

3. Min / max display

You can also display the values in a simple way when using this option , only for min. value, typical value, max. value. But the values will comply with the decimal, hexadecimal or percent display mode what you have set.

Supposed that you have set the percent display mode. If there is no signal input, the LCD shows as follows.

≤ RX Channel : 000
 Chan. Min typ max
 >001 --- --- ---
 >Count at : xxxxx Second

On the contrary, if the signal input has been received correctly, the LCD window displays the following diagram.(e.g. DC-1216II)

≤ RX Channel : 192
 Chan. Min typ max
 >001 000 28 70
 >Count at : 00010 Second

Total channels

Time counter for reference.

Note: The min value display is the min. value of all the adjustments referring to the present channel; the typ value display is the set value of the present channel; the max display is the max. Value of all the adjustments referring to the present channel.

To browse the value of each channel, turn the Dial wheel to select > at the third line of LCD window, then press the Dial wheel. At this time you can browse the desired channel by turning the Dial wheel backward or forward.

DMX data -- TX

When switching on the unit, the receiving DMX signal can be transmitted automatically, with the STARTCODE you have set. Supposed that you aren't in this DMX data--TX menu now and there is no DMX signal input, if you have run the specific saved cue just now , the cue will be transmitted repeatedly.

In this case the new coming DMX signal will have priority to be transmitted. However, when accessing the Cable Test or MIDI data-RX menus, the transmitting signal will be halted.

While accessing this DMX data--TX menu, new coming DMX signal will be disabled. You are allowed to temporarily set the levels for the intended channels, and also have priority to transmit cue (scene) at a set rate. Remember there are 99 cues available.

Turn the Dial wheel to select **DMX data--TX** and then press the Dial wheel to access this menu function. There are 4 sub-menu options, including **512 Channel, Single Channel, Cue/Memory, Run Cues (Scenes)**.

1. 512 Channel

This option can display the levels of 512 channels, and also be used for temporary adjustments, while the actual channel value can be held. When using the Dial wheel to enter this sub-menu, the LCD window usually shows as follows:

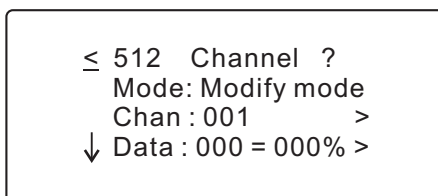

To adjust the temporary value of the desired channel, first enable the Dial wheel to > at the third line. Then adjust the "Data" at the fourth line. The "Data" display the value by the means of decimal and percent.

You may turn the Dial wheel to scroll to the next page. The LCD window shows the values of 10 channels at the following diagram.

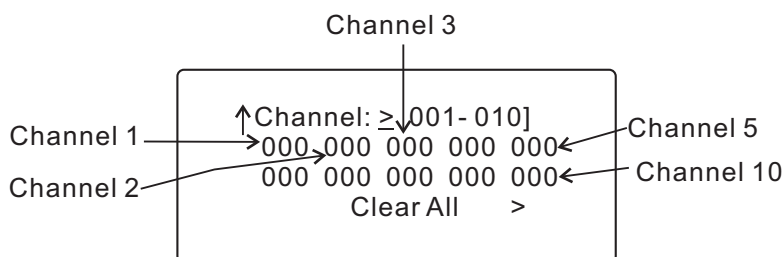

You can set these values of 10 channels (001 -- 010).For example, set the value for channel 1. Locate the cursor to the desired channel, press the Dial wheel to select it.Then turning the Dial wheel to adjust the level. When satisfying the adjustment, press the Dial wheel again to confirm the settings.

You may also adjust the other 502 channels levels. Locate the cursor to > at the first line of LCD,press the Dial wheel and turn it to the desired channels for new settings. Remember that there are only 10 continual channels available for your choices every time.

If you would like to set these 512 channels to be 000, use the Clear All function by pressing the > at the fourth line.

Locate the label ? for more details. Help information shows as follows.

≤ 512 Channel
Modify = Each
Channel will hold
its preset value

2. Single Channel

Turn the Dial wheel to select **Single Channel** option. You can adjust the speed, channel, mode, level for your requirements when applying this function. The speed value can be increased from 1 to 10. And there are 5 modes for reference, including Fade Only, Fade Fine, Auto On/ Off, Ramping, Stop.

Fade Only: Changing the channel value by Dial Wheel in the range of 0~255.

Fade Fine: Based on the initial channel value of Fade Only , turn the dial wheel can increase the value one by one. When the increment value is 31, turn the dial wheel will change the channel value into the initial value.

Auto On/Off: The channel value will be changed between 000 and 255, complying with the speed.

Ramping: The channel value will steadily increase one by one till to 255, complying with the speed. Then repeat the sequence of 0 to 255.

Stop : The channel value can not be changed and held.

The LCD window usually shows the following diagram.

≤ Auto Speed : 01 > ?
Chan : 001 >
Mode: Fade Only >
Level : 000 = 000% >

The Speed can only be taken effect when the mode is set to Auto On/Off or Ramping. In this case, the level of the desired channel is adjusted automatically by this unit.

You can adjust the level by dial wheel when the mode is set to Fader Only or Fader Fine. However, there is only one channel level varied from the other 511 channels levels. And the other 511 channels levels are zero.

In addition, when the channel is set to be " 001 - 512 (all) ", you can set all the 512 channels to the same values.

Locate the label ? for more details. Help information shows as follows.

≤ 2. Signal Channel
512 data is same, or
one data is special
the others are zero

3. Cue/Memory

This option can transmit the received data saved as cues. Remember that there are 99 Cues available for you. Therefore the Cue number is at most 99. When turn the Dial wheel to select this function, the LCD window shows a message as follows:

≤ 3. TX data as Cue ?
Cue number: 001 >

To transmit data saved the desired cue, turn the Dial wheel to select the cue, then press the Dial wheel again to confirm. The cue will automatically be transmitted.

Locate the label ? for more details. Help information shows as follows.

≤ The 512 data of cue
come from RX or from
old cue which can be
modified in 'TX-512'

If you desire to modify a saved CUE for sending or saving, you can raise this CUE from "TX data as Cue" and go to "TX-512 Channel" menu for modification. Then you can save it into a specific number while you accessed " Save Cue" menu. This function can be done only NO DMX signal input.

4. Run Cues (Scenes)

Turning the Dial wheel to select **Run Cues(Scenes)** , you can transmit cues continually at a specific rate. When accessing this option, the LCD window shows the following diagram.

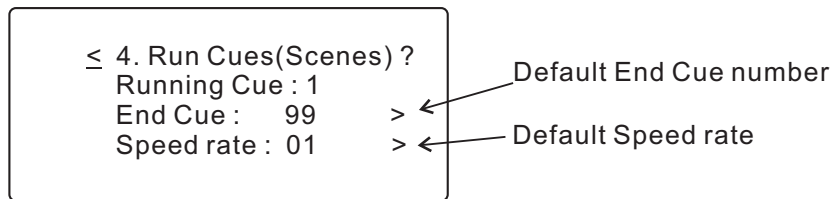

The default start cue is cue 1. You can adjust the end cue No. and speed rate (1 -10) by Dial wheel.

For more information, press ? for help.

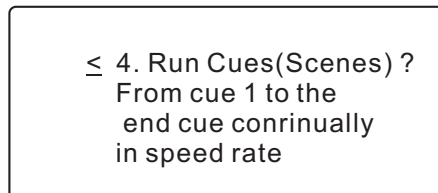

RDM Control

Turn the Dial wheel to select **RDM Control** and then press the Dial wheel to access this menu function. There are 2 sub-menu options, including DISC COMMAND, GET or SET COMMAND mode. The LCD window usually shows as follows:



- 1) In the RDM system the RDM function of Dr.DMX III was used as a controller.
- 2) For the 2 sub-menus of RDM control, you can carry out "SET or SET COMMAND" only you successfully performed "DISC_COMMAND " first.

1. DISC-COMMAND

Turn and press the Dial wheel to access DISC-COMMAND function. If your unit have linked to any RDM device, the LCD window will show you as follows:

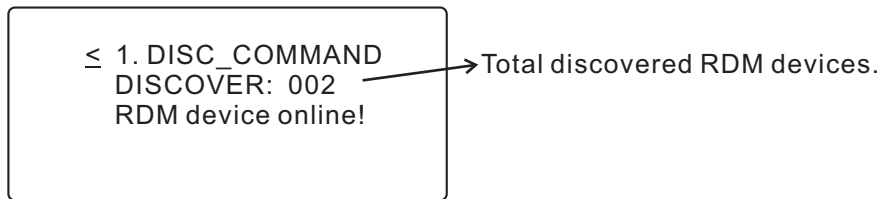

2.GET or SET COMMAND

Turn and press the Dial wheel to access GET or SET COMMAND function. If your unit doesn't link to any RDM device, the LCD window will show you as follows:

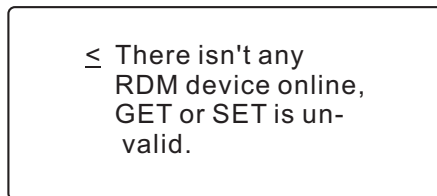

If your unit discovered any RDM devices linking to your unit, the LCD window will show you ,

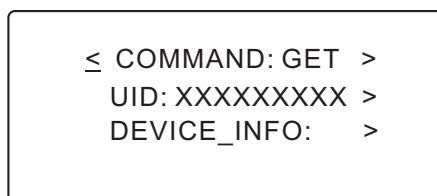

Turn the dial wheel to select the ">" of the second line right, you can select an unit ID and view it.

Turn the dial wheel to select the ">" of the third line right, you can select and view the details of each parameter. There are 45 parameters available for "COMMAND: GET"(Please refer to the tables on the following pages for details).

Turn the dial wheel to select the ">" of the first line right, you can swap "GET" and "SET". To select "SET", the LCD show you as follows:

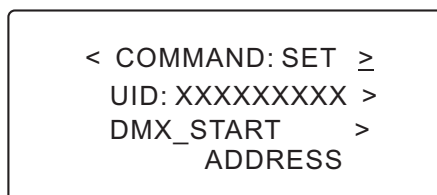

Turn the dial wheel to select the ">" of the second line right, you can select the unit you want to set the command for it.

Turn the dial wheel to select the ">" of the third line right, you can select and set the value for each parameter. There are 28 parameters available for "COMMAND: SET"(Please refer to the tables on the following pages for details).

NOTE

- 1)For "COMMAND:GET", when the UID(Unique ID) was chosen, the PID (parameter ID) can only be selected in the range of which the device supported, a part of the 45 PIDs or all of them.
- 2)Likewise, for "COMMAND:SET", the PID can only be selected in the range of which the device supported as well, a part of the 28 PIDs or all of them.
- 3)The manufacturer specific PIDs are displayed with hex form and which were excluded from the above 45 or 28 PIDs .
- 4)You can carry out GET "DMX_PERSONALITY_DESCRIPTION", GET"SENSOR_DIFINITION" and GET"SENSOR_VALUE" only you if perform GET " DEVICE_INFO" first.
- 5)You can GET or SET the relevant PID only if you perform GET " PARAMETER_DESCRIPTION" first.(" PARAMETER_DESCRIPTION" is a description for the relevant manufacturer specific PID.)
- 6)You can carry out GET "STATUS-ID_MESSAGES" only if you perform GET " STATUS_MESSAGES" first.

Tabel-1:RDM Categories/Parameter ID Defines

Get Allowed	Set Allowed	RDM Parameter ID's(Slot 21-22)	Value	Comment	Required
		Category-Network Management			
		DISC_UNIQUE_BRANCH	0x0001		✓
		DISC_MUTE	0x0002		✓
		DISC_UN_MUTE	0x0003		✓
✓		PROXIED_DEVICES	0x0010		
✓		PROXIED_DEVICES_COUNT	0x0011		
✓	✓	COMMS_STATUS	0x0015		
		Category-Status Collection			
✓		QUEUED_MESSAGE	0x0020	See Table-2	
✓		STATUS_MESSAGES	0x0030	See Table-2	
✓		STATUS_ID_DESCRIPTION	0x0031		
	✓	CLEAR_STATUS_ID	0x0032		
✓	✓	SUB_DEVICE_STATUS_REPORT_THR ESHOLD	0x0033	See Table-2	
		Category-RDM Information			
✓		SUPPORTED_PARAMETERS	0x0050	*Support required only if supporting Parameters beyond the minimum required set.	✓*
✓		PARAMETER_DESCRIPTION	0x0051	*Support required for Manufacture-Specific PIDs exposed in SUPPORTED_PARAMETERS message	✓-
		Category-Product Information			
✓		DEVICE_INFO	0x0060		✓
✓		PRODUCT_DETAIL_ID_LIST	0x0070		
✓		DEVICE_MODEL_DESCRIPTION	0x0080		
✓		MANUFACTURER_LABEL	0x0081		
✓		DEVICE_LABEL	0x0082		
✓		FACTORY_DEFAULTS	0x0090		
✓		LANGUAGE_CAPABILITIES	0x00A0		
✓	✓	LANGUAGE	0x00B0		
✓		SOFTWARE_VERSION_LABEL	0x00C0		✓
✓		BOOT_SOFTWARE_VERSION_ID	0x00C1		
✓		BOOT_SOFTWARE_VERSION-LABEL	0x00C2		
		Category-DMX512 Setup			
✓	✓	DMX_PERSONALITY	0x00E0		
✓		DMX_PERSONALITY_DESCRIPTION	0x00E1		
✓	✓	DMX_STAR_ADDRESS	0x00F0	*Support required if device uses a DMX512 Slot.	✓*
✓		SLOT_INFO	0x0120		
✓		SLOT_DESCRIPTION	0x0121		
✓	✓	DEFAULT_SLOT_VALUE	0x0122		

Get Allowed	Set Allowed	RDM Parameter ID's(Slot 21-22)	Value	Comment	Required
		Category-Sensors	0x02xx		
✓		SENSOR_DEFINITION	0x0200		
✓	✓	SENSOR_VALUE	0x0201		
	✓	RECORD_SENSORS	0x0202		
		Category-Dimmer Settings	0x03xx	Future	
		Category-Power/Lamp Settings	0x04xx		
✓	✓	DEVICE_HOURS	0x0400		
✓	✓	LAMP_HOURS	0x0401		
✓	✓	LAMP_STRIKES	0x0402		
✓	✓	LAMP_STATE	0x0403	See Table-4	
✓	✓	LAMP_ON_MODE	0x0404	See Table-5	
✓	✓	DEVICE_POWER_SYCLES	0x0405		
		Category-Display Settings	0x05xx		
✓	✓	DISPLAY_INVERT	0x0500		
✓	✓	DISPLAY_LEVEL	0x0501		
		Category-Configuration	0x06xx		
✓	✓	PAN_INVERT	0x0600		
✓	✓	TILT_INVERT	0x0601		
✓	✓	PAN_TILT_SWAP	0x0602		
✓	✓	REAL_TIME_CLOCK	0x0603		
		Category-Control	0x10xx		
✓	✓	IDENTIFY_DEVICE	0x1000		✓
	✓	RESET_DEVICE	0x1001		
✓	✓	POWER_STATE	0x1010		
✓	✓	PERFORM_SELFTEST	0x1020	See Table-7	
✓		SELF_TEST_DESCRIPTION	0x1021	See Table-6	
	✓	CAPTURE_PRESET	0x1030		
✓	✓	PRESET_PLAYBACK	0x1031	See Table-3	
		ESTA Reserved Future RDM Development	0x7FE0-0X7FFF		
		Manufacture-Specific PIDs	0x8000-0XFFDF		
		ESTA Reserved Future RDM Development	0xFFE0-0XFFFF		

Tabel-2: Status Type Defines

Status Type Defines	Value	Comment
STATUS_NONE	0x00	Not allowed for use with GET: QUEUED_MESSAGE
STATUS_GET_LAST_MESSAGE	0x01	
STATUS_ADVISORY	0x02	
STATUS_WARNING	0x03	
STATUS_ERROR	0x04	

Tabel-3: Preset Playback Defines

Preset Playback Defines	Value	Comment
PRESET_PLAYBACK_OFF	0x0000	Returns to Normal DMX512 Input
PRESET_PLAYBACK_ALL	0xFFFF	Plays Scenes in Sequence if supported.
PRESET_PLAYBACK_SCENE	0x0001-0xFFFE	Plays individual Scene #

Tabel-4: Lamp State Defines

Lamp State Defines	Value	Comment
LAMP_OFF	0x00	No demonstrate light out
LAMP_ON	0x01	
LAMP_STRIKE	0x02	Arc-Lamp ignite
LAMP_STANDBY	0x03	Arc-Lamp Reduced Power Mode
LAMP_NOT_PRESENT	0x04	Lamp not installed
LAMP_ERROR	0x7F	
Manufacturer_Specific States	0x80-0xDF	

Tabel-5: Lamp On Mode Defines

Lamp On Mode Defines	Value	Comment
LAMP_ON_MODE_OFF	0x00	Lamp Stays off until directly instructed to strikes.
LAMP_ON_MODE_DMX	0x01	Lamp Strikes upon receiving a DMX512 signal.
LAMP_ON_MODE_ON	0x02	Lamp Strikes automatically at Power-up.
LAMP_ON_MODE_AFTER_CAL	0x03	Lamp Strikes after Calibration or Homing procedure.
Manufacturer_Specific States	0x80-0xDF	

Tabel-6: Self Test Defines

Self Test Defines	Value	Comment
SELF_TEST_OFF	0x00	Turns Self Tests Off
Manufacturer Tests	0x01_ 0xFE	Various Manufacturer Self Tests
SELF_TEST_ALL	0xFF	Self Test All, if applicable

Tabel-7: Power State Defines

Power State Defines	Value	Comment
POWER_STATE_FULL_OFF	0x00	Completely disengages power to device. Device can no longer respond.
POWER_STATE_SHUTDOWN	0x01	Reduced power mode, may require device reset to return to normal operation. Device still responds to messages.
POWER_STATE_STANDBY	0x02	Reduced power mode. Device can return to NORMAL without a reset. Device still responds to messages.
POWER_STATE_NORMAL	0xFF	Normal Operating Mode.

DMX-1000K Mode

Turn the Dial wheel to select **DMX-1000K** and then press the Dial wheel to access this menu function. There are 3 sub-menu options, including DMX-1000K RX, DMX-1000K TX and TX Single chanl mode. The LCD window usually shows as follows:

≤ DMX-1000K Mode	?
1. DMX-1000K RX	>
2. DMX-1000K TX 2048	>
3. TX Single chanl	>

Turn and press the Dial wheel to access "?" for help, the LCD window shows you as follows:

```
< DMX-1000K Mode ?
At this, all init
buffer is zero.
Bandrate is 1000Khz.
```

1. DMX-1000K RX

Turn and press the Dial wheel to access DMX-1000K RX. The LCD window shows you as follows and you can use the dial wheel to set the start channel.

```
≤ 1. RX Channel: 0000
Star Channel:0001 >
-----
-----
```

2. DMX-1000K TX 2048

Turn and press the Dial wheel to access DMX-1000K TX 2048. The LCD window shows you as follows and you can use the dial wheel to set the channel value.

```
≤ 2. TX 2048 Channel
Channel:[0001-0010] >
000 000 000 000 000
000 000 000 000 000
```

3. TX Single Chanl

Turn and press the Dial wheel to access TX Single Chanl. The LCD window shows you as follows and you can use the dial wheel to set the corresponding value.

```
≤ Auto Speed : 01 >
Chan: 0003 >
Mode: Fader Only >
Level: 000=000% >
```

Decimalism or Hex Percent

The Auto Speed can be set in the sort of 1~10.

Chan(Channel): There is only one channel level varied from the other 2047 channels levels. And the other 2047 channels levels are zero. Or, you can set the channel level as " 001 - 512 (all) ", so all the 512 channels will have the same value.

The Mode can be set as Fade Only, Auto on/off or Ramping.

The Level can be set in the range of 1~255 which was expressed as the mode of "Decimalism----Percent" or "Hex----Percent".

Moving light

Turn the Dial wheel to select **Moving light** and then press the Dial wheel to access this menu function. There are 2 sub-menu options, including **Library setting** , **Play mode**. You can set the function of each fixture channel, complying with the present library. The library of this unit is preset to meet your requirements in general. If you would like to use your own library, please mail us an attachment of this information for update. For more tests, in the **Play Mode** you can use the library settings and adjust the parameters of relative channels for this purpose. After accessing the **Moving light**, the LCD window usually shows as follows:

```

≤ Moving light :
  1. Library setting >
  2. Play mode      >

```

1. Library setting

To set the lighting function of the desired channel, you can use Dial wheel to access this option. The LCD window will show the fixture number, name and function of each channel. Remember that there are only 36 channels and 10 kind of fixtures in all, which can be set. And each channel has 29 effect functions to be selected.

```

≤ 1. Library setting >
  FX No.:01 NAME_1 >
  01 Pan  02 Tilt
  03 Focus 04 Frost

```

You can adjust the fixture number, name and function of each channel by Dial wheel.

If you would save your new settings, press > at the first line of LCD window, the label displays "Library stored". Pressing the Dial wheel again to save the present fixture settings.

To change the fixture name, locate the cursor to the label > and press the Dial wheel . The label > will change to ? , then you can locate the desired characters and press the Dial wheel. Label ?? Appears, then you can enter a new character by turning the Dial wheel. Press Dial wheel to confirm your setting. Repeat the procedures for the adjustment of any other characters.

To change the lighting function of the desired channel, e.g. channel 1. First locate the cursor to 01 and press the Dial wheel. Then turn the Dial wheel to the right lighting function and press the Dial wheel to confirm.

You can turn the Dial wheel to browse the functions of other channels.

If you would like to set the lighting function of this unit for testing the other lighting equipments, do pay attention to the relative channels parameters of them. What you have set must be complying with the devices.

2. Play mode

In this function you can test the fixtures by using the previous library settings. Turn on the Dial wheel to select **Play mode** . The LCD window a message as follows:

```

≤ 2. Play mode
  FX No.:01 NAME_1 >
  Start address: 001 >
  Func : Pan> 001 >

```

Locate to > at the second line and turn the Dial wheel. Then you can select the set fixture name. The relative library settings can be available. Complying with the fixture channel, locate to > at the third line and turn the Dial wheel to set the right start address.

```

≤ 2. Play mode
  FX No.:01 NAME_1 >
  Start address: 001 >
  Func : Pan> 001 >

```

↑
Part 1

← Part 2

For some tests, first locate the > at the part [1] to select the desired function. Then locate the > at the part [2] to adjust the level by turning the Dial wheel.

Supposed that the start address is assigned to 001 and function is set to Pan, complying with the specific fixture. Then change the level. The fixture arms will rotate horizontally at your disposal. For another option, pressing < will give access to the previous menu. Continue to press < again for main menus. Turning the Dial wheel can display the other main menus.

Save Cue (Scene)

If there is DMX signal input at present, the saved cue can be the received signal. However, when no signal input, enabling this Save Cue function will save the previous received or running cue as new one. By the way, you can access the 512 channel of DMX data--TX menu to set values of the desired channels or modify the existed cue, and then enabling this Save Cue can also save the settings as new cue.

When accessing this menu, the LCD window will ask for you the cue number to be saved.

```

≤ Save Cue ( Scene ) ?
  As Cue No.: 001 >
  Confirm >

```

The default cue no. is preset to be 001. You can change the default cue number to the desired one. First locate to > at the second line and turn the Dial wheel for this purpose. To save the received data, press > at the third line to confirm. Otherwise, automatically save the received data and the cue number will increase by 1 for the next saving.

NOTE: After you have locate to > at the second line, turning the Dial wheel can allow you to select the " Clear all Cues ". When you confirm this function, the LCD window will ask for you " Be sure ? Yes > No > " at the fourth line . Press the first label > to confirm, all the stored cues will be cleared out. For no clearing the cues, press the second label > to quit. For more information,press ? for help.

≤ Save Cue (Scene)
The cue with 512 data
can be stored to
memory or clear cues

Cable test

When enable this function, you can test the cable whether there are errors or not.

Use the standard DMX In/Output of this unit for connecting the cable. One head for female plug-in, another head for male plug-in. Then press > at the fourth line to start the test, If the cable works normal, the LCD window shows as follows:

≤ Cable Test ---
Result:
> Cable Pass

Otherwise, if the cable can not work normal, the LCD window shows:

≤ Cable Test ---
Result:
> Cable failure

MIDI data -- RX

This option can test whether there are some errors when transmitting MIDI data. When the cable isn't connected normal and you have accessed this function, the LCD window usually shows .

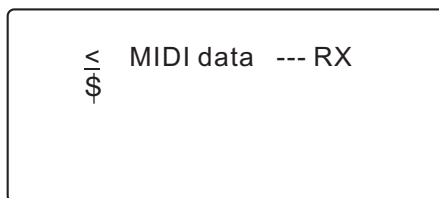

However, if there are signal inputs and no errors, the LCD window usually shows as follows:

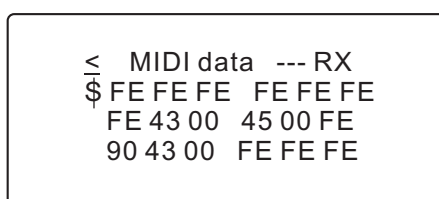

FE means NULL signal

System setup

In this menu you can set the system settings at your disposal. There are three sub-menus for your choice, including DMX setting, Language, Display setting. You can set the DMX display mode, value display mode, and so on.

Turn the Dial wheel to System setup and press it to enable this function. The LCD window shows as follows.

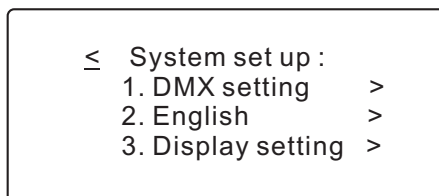

1. DMX setting

Turn the Dial wheel to DMX setting and press it, then the LCD window shows the following message for you.

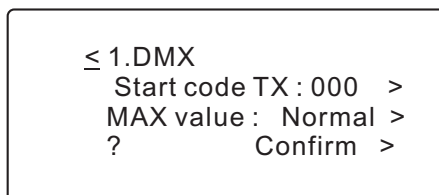

You can set the start code for DMX 512 signal transmission. Generally, you need not to adjust it.

The default of start code is set to 000. If you would like to amend it, use the Dial wheel for this purpose.

There are two modes for MAX value: Normal and Hold Mode.

Turn the Dial wheel to > at the second line, then pressing it can shift between Normal mode and Hold mode.

2. English

The instruction language is available in English for your Dr.DMX III.

3. Display setting

In this sub-menu you can adjust the contrast level of the LCD window by Dial wheel. The default level is 05 and it must range from 01 to 10.

```
≤ Contrast_Level : 06 >  
Back light : off >  
Display : percent >  
? Confirm >
```

To change the state of back light, you can enable the label > at the second line. Pressing the Dial wheel to turn on/off the back light, while pressing it again to complete your setting and exit "Back light".

You can also change the value display in three modes, including decimal, hexadecimal and percent. To save what you have set, press the label > at the fourth line to confirm by Dial wheel. Without saving, enable the label < to return the previous menu.

For more information, press ? for help.

```
≤ 3. Display setting  
Contrast_level: 1-10  
Back light : On/Off  
dec, hex or % data
```

Software Updating

Requirements

It is required to prepare the following items prior to update your DR.DMX III.

- 1) A Ulink DMX cable from us.
- 2) A downloading software ----VSave.exe we provided.
- 3) Possibly, the updated software DrDMXIIIPro.bin we may provide to you for your software updating.

Process

- 1) Connect USB port of the computer to DMX in of Dr.DMX III with the Ulink cable .
- 2) Press the dial wheel, hold on and power on the Dr.DMX III, your RDM tester will access to the state of waiting for downloading at this time. The LCD shows "Software Update...".
- 3) Run VSave.exe, and in sequence to click "19200", "Select Ulink" ,"Send File" with your mouse, then select "DrDMXIIIPro.bin" file.
- 4) After download is completed, power on your RDM tester again and it will run the new software accordingly.

All rights reserved.