



Control[®] 128W/WT Premium In-Wall Loudspeaker

Professional Series

Key Features:

- ▶ Components:
 - 200 mm (8 in) polymer-coated aluminum-cone woofer with pure butyl rubber surround.
 - 25 mm (1 in) pure-titanium dome low-diffraction swivel aimable titanium tweeter.
- ▶ High-slope crossover for natural midrange sound.
- ▶ Extended bandwidth performance of 30 Hz – 20 kHz.
- ▶ 60W continuous (120W program, 240W peak) power handling (128W).

The Control 128W is a premium in-wall speaker within the JBL Professional Control[®] Contractor line designed for applications such as foreground music, boardrooms, reception areas, airports, convention centers, cruise ships, retail outlets, restaurants, museums, surround locations, or any critical listening application where top performance from a loudspeaker with minimal visual impact is required.

The high-performance woofer features a polymer-coated aluminum cone for high performance down to 30 Hz and pure butyl rubber surround for long-life and high reliability along with extended-polepiece magnet design for long excursion and tight, low bass. The pure titanium dome high frequency driver is loaded with a built-in EOS[™] (Elliptical Oblate Spheroidal) waveguide for low distortion and a smooth frequency response. A low-diffraction swivel-mounting system enables the user to direct high frequencies where required without the diffraction distortion inherent in other aimable tweeter designs. A high-slope crossover network maintains natural midrange sound and produces more even coverage throughout the listening area. The optional Control 128WT version includes a multitap transformer for 70V/100V systems.

The Control 100 Series speakers are voiced similarly to other JBL Control Contractor models, allowing mixing with surface-mount and in-ceiling speakers within a single listening space. The premium sound quality makes these loudspeakers ideal for critical listening environments, yet they are high power and rugged enough to handle venues requiring high-SPL, heavy duty-cycle music.

The speaker fits into the wall space of ordinary stud-wall construction. An optional rough-in frame is available for installing the speakers into standard stud walls in new-construction projects. As is the case with all Control Contractor speakers, the baffles and grilles are paintable to match any décor.



Specifications:

System:	
Frequency Range (-10 dB) ¹ :	30 Hz - 20 kHz
Continuous Power Capacity ² :	240 Watts Peak 120 Watts Continuous Program 60 Watts Continuous Pink Noise
Sensitivity ³ :	90 dB SPL, 1W, 1 m (3.3 ft)
Nominal Impedance (128W):	8 ohms
Transformer Taps (128WT):	70V: 50W, 25W, 12W & 6W taps 100V: 50W, 25W, & 12W taps
Transducers:	
<u>Low-Frequency:</u>	200 mm (8 in) polymer-coated aluminum cone, pure butyl rubber surround.
<u>High-Frequency:</u>	25 mm (1 in) pure-titanium dome with cloth suspension on low-diffraction swivel-mount with -10 degree aimability.
Physical:	
Termination:	Screw-down Euroblock-type connector. Max. wire size 14 AWG (1.5 mm) ²
Crossover Network:	2nd order low-pass to the woofer and 2nd order high-pass to the tweeter.
Optimum Air Cavity Behind Speaker:	40 to 80 liters (1.4 to 2.8 cu ft)
Outside Dimensions (H x W x D):	334 x 257 x 110 mm (13.1 x 10.1 x 4.3 in), 102 mm (4.0 in) front of wall to back of speaker.
Cutout Size (H x W):	300 x 225 mm (11.9 x 8.9 in), Cutout template included.
Maximum Wall Thickness:	32 mm (1.25 in)
Net Weight (ea):	128W: 2.6 kg (5.5 lb), 128WT: 3.3 kg (7.2 lb)
Shipping Weight (pair):	128W: 5.9 kg (13.0 lb), 128WT: 7.8 kg (17.2 lb)
Included Accessories:	Cutout template & paint shield
Optional Accessories:	MTC-128RIF Rough-In Frame for new construction installation to wallstuds.

¹Half-space (mounted in-wall)

²Continuous Pink Noise rating is IEC-shaped pink noise with a 6 dB crest factor.

³Half-space (mounted in-wall), average 100 Hz to 10 kHz

JBL continually engages in research related to product improvement. Some materials, production methods and design refinements are introduced into existing products without notice as a routine expression of that philosophy. For this reason, any current JBL product may differ in some respect from its published description, but will always equal or exceed the original design specifications unless otherwise stated.

Rear Air Cavity Considerations

The Control 128W is designed to function over a wide span of rear air cavity sizes within the wall. The optimum air cavity (sometimes called "loading volume") for fullest low-frequency performance is between 40 to 80 liters (1.4 to 2.8 cu ft). In a wall with studs located 16-inches on-center, this approximately equals a 46-inch to 92-inch high space. It is recommended that the air cavity behind the speaker be sealed by the use of silicone sealant or similar material to help create an air-tight seal and minimize wall noise.

▶ Control® 128W/WT Premium In-Wall Loudspeaker

Frequency Response

Measured on-axis with distance referenced to 1 meter at 1 watt, half-space (128W).

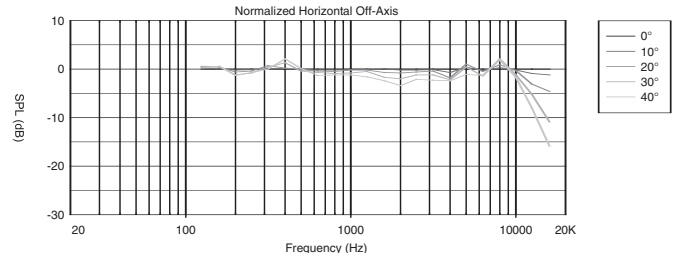
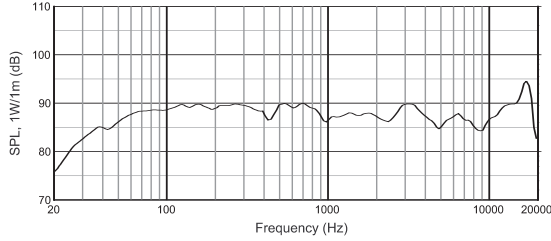

Impedance (128W)

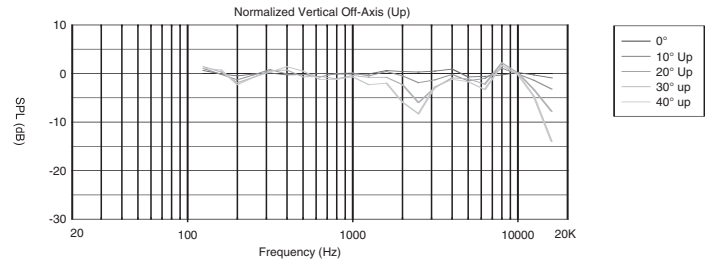
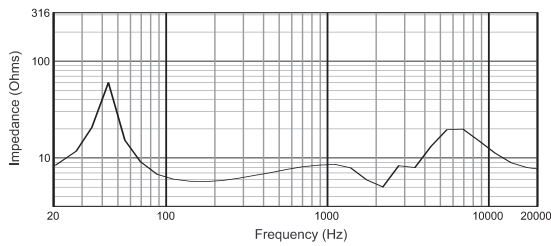

Beamwidth

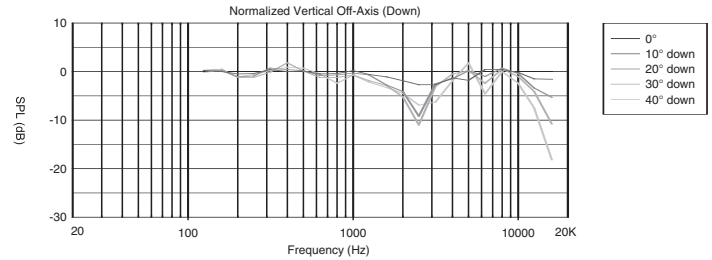
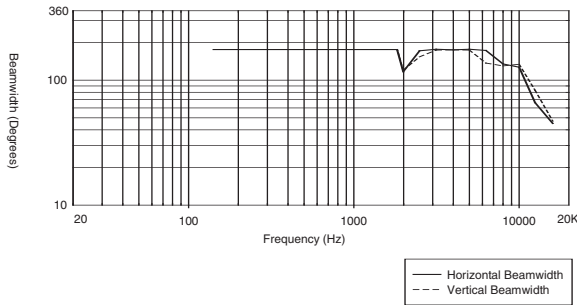

Dimensional Drawing

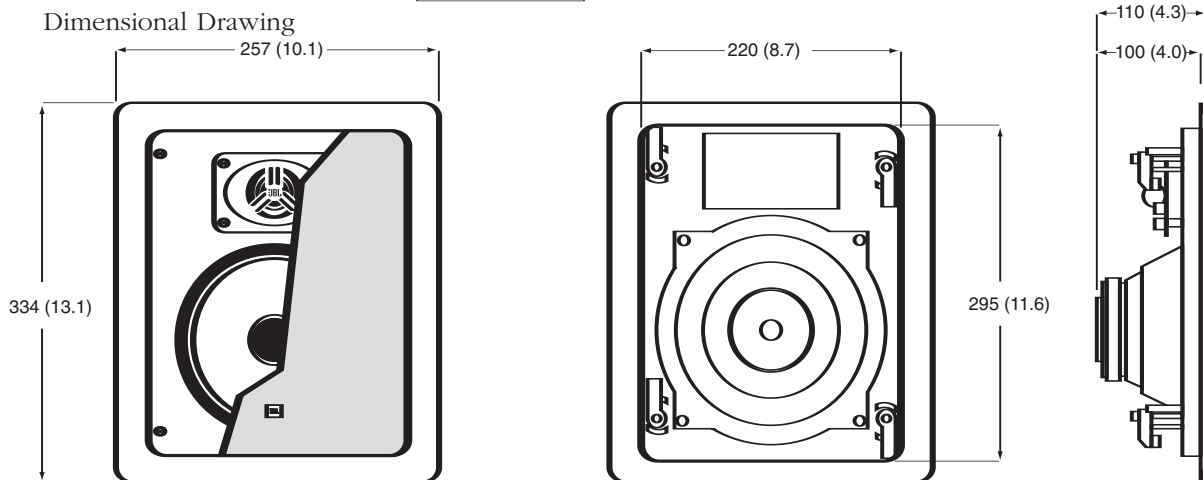

JBL Professional
8500 Balboa Boulevard, P.O. Box 2200
Northridge, California 91329 U.S.A.

■ A Harman International Company
© Copyright 2004 JBL Professional

SS Control 128WT
CRP 5M
12/04