

OPERATING MANUAL



MC-6

AES3-S/P-DIF DIGITAL AUDIO FORMAT AND SAMPLING RATE CONVERTER



SAFETY INSTRUCTIONS

General instructions

To reduce the risk of fire or electrical shock, do not expose this appliance to rain or moisture, direct sunlight or excessive heat from sources such as radiators or spotlights. No user serviceable parts are inside. Repair and maintenance must be carried out by qualified personnel authorized by MUTECH GmbH! The unit has been designed for operation in a standard domestic environment. Do NOT expose the unit and its accessories to rain, moisture, direct sunlight or excessive heat produced by such heat sources as radiators or spotlights! The free flow of air inside and around the unit must always be ensured.



Initial operation

Prior to the initial operation of the unit, the appliance, its accessories and packaging must be inspected for any signs of physical damage that may have occurred during transit. If the unit has been damaged mechanically or if liquids have been spilled inside the enclosure, the appliance may not be connected to the mains or must be disconnected from the mains immediately! If the unit is damaged, please do NOT return it to MUTECH GmbH, but notify your dealer and the shipping company immediately, otherwise claims for damage or replacement may not be granted.

If the device is left in a low-temperature environment for a long time and then is moved to a room-temperature environment, condensation may occur on the inside and the exterior. To avoid short-circuits and flashovers, be sure to wait one or two hours before putting the device into operation.

Power supply

The device contains a self-adapting wide-range power supply supporting the majority of global standard line voltages within a range of 90...250 V, with no need for making adjustments. Make sure that your line-voltage source provides a supply voltage within the specified range. In addition, make sure that the device is properly grounded via the local electric installation.

Please use the enclosed power cord (see packaging) to connect the unit to the mains. Switch the unit off before you attempt to connect it to the mains. Connect the power cord to the unit, then to a standard 3-pin mains outlet. To draw the power cord, never pull on the cable but on the mains plug!

The unit must be grounded during operation!

For information on the power-inlet wiring, refer to the »Wiring of connectors« section in the appendix. Disconnect the device from the mains when not using it for an extended period!



This symbol, a flash of lightning inside a triangle, alerts you to the presence of uninsulated dangerous voltage inside the enclosure - voltage that may be sufficient to constitute a risk of shock.



This symbol, an exclamation mark inside a triangle, alerts you to important operating or safety instructions in this manual.

Declaration of Conformity

We herewith confirm that the product complies with the European Commission's standards on electromagnetic compatibility.

Interference emission: EN 50081-1, 1992
Resistance to interference: EN 50082-1, 1992

Presupposed as operation condition is that all clock outputs are connected with high-quality and good shielded BNC 75 ohms cable.



WARRANTY REGULATIONS

§1 Warranty

MUTECH GmbH warrants the flawless performance of this product to the original buyer for a period of two (2) years from the date of purchase. If any failure occurs within the specified warranty period that is caused by defects in material and/or workmanship, MUTECH GmbH shall either repair or replace the product free of charge within 90 days. The purchaser is not entitled to claim an inspection of the device free of charge during the warranty period. If the warranty claim proves to be justified, the product will be returned freight prepaid by MUTECH GmbH within Germany. Outside Germany, the product will be returned with the additional international freight charges payable by the customer. Warranty claims other than those indicated above are expressly excluded.

§2 Warranty transferability

This warranty is extended exclusively to the original buyer who bought the product from a MUTECH GmbH specialized dealer or distributor, and is not transferable to anyone who may subsequently purchase this product. No other person (retail dealer, distributor, etc.) shall be entitled to give any warranty promise on behalf of MUTECH GmbH.

§3 Warranty regulations

The return of the completed registration card, or online registration on one of the websites specified below, is a condition of warranty. Failing to register the device before returning it for repair will void the extended warranty.

- The serial number on the returned device must match the one stated on the registration card or entered during online registration. Otherwise, the device will be returned to the sender at the sender's expense.
- Any returned device must be accompanied by a detailed error description and a copy of the original sales receipt issued by a MUTECH dealer or distributor.
- The device must be returned free of shipping expenses and in the original package, if possible; otherwise, the sender has to provide comparably protective packaging.
- The sender is fully responsible for any damage or loss of the product when shipping it to MUTECH GmbH.

§4 Limitation of warranty

Damages caused by the following conditions are not covered by this warranty:

- Damages caused by every kind of normal wear and tear (e.g. displays, LEDs, potentiometers, faders, switches, buttons, connecting elements, printed labels, cover glasses, cover prints, and similar parts).
- Functional failure of the product caused by improper installation (please observe CMOS components handling instructions!), neglect or misuse of the product, e.g. failure to operate the unit in compliance with the instructions given in the user or service manuals.
- Damage caused by any form of external mechanical impact or modification.
- Damage caused by the user's failure to connect and operate the unit in compliance with local safety regulations.
- Damage caused by force majeure (fire, explosion, flood, lightning, war, vandalism, etc.).
- Consequential damages or defects in products from other manufacturers as well as any costs resulting from a loss of production.

Repairs carried out by personnel which is not authorized from MUTECH GmbH will void the warranty. Adaptations and modifications to the device made with regard to national, technical, or safety regulations in a country or of the customer do not constitute a warranty claim and should be set with MUTECH GmbH in advance.

§5 Repairs

To obtain warranty service, the buyer must call or write to MUTECH GmbH before returning the unit. All inquiries must be accompanied by a description of the problem and the original buyer's invoice. Devices shipped to MUTECH GmbH for repair without prior notice will be returned to the sender at the sender's expense. In case of a functional failure please contact:

MUTECH Gesellschaft fuer Systementwicklung und Komponentenvertrieb mbH
Siekeweg 6/8 • 12309 Berlin • Germany • Fon 030-746880-0 • Fax 030-746880-99 • Tecsupport@MUTECH-net.de • www.MUTECH-net.de

JET AND JITTER ELIMINATION TECHNOLOGY ARE TRADEMARKS OF TC APPLIED TECHNOLOGIES LTD. THE JET TECHNOLOGY IS USED UNDER SUBLICENSE FROM TC APPLIED TECHNOLOGIES LTD., AND IS THE INTELLECTUAL PROPERTY OF SONOPSIS LTD. APPLICABLE PATENTS INCLUDE WO2004088845.

MUTECH GMBH ASSUMES NO LIABILITY FOR ANY INCORRECT INFORMATION GIVEN IN THIS MANUAL. PLEASE NOTE THAT ALL SOFTWARE/HARDWARE PRODUCT NAMES ARE REGISTERED TRADEMARKS OF THEIR RESPECTIVE OWNERS. NO PART OF THIS MANUAL MAY BE REPRODUCED, COPIED OR CONVERTED TO A MACHINE-READABLE FORM OR ELECTRONICAL MEDIA WITHOUT A WRITTEN PERMISSION OF MUTECH GMBH. WE RESERVE THE RIGHT TO CHANGE OR IMPROVE OUR PRODUCTS WITHOUT PRIOR NOTICE. © MUTECH GMBH 2010

■ CONTENT

■ INTRODUCTION

General Function Description	7
MC-6 Features	7
MC-6 Applications	7
Peripheral MUTECH Products	8

■ CONTROL ELEMENTS AND TERMINALS

MC-6 Front Panel	9
MC-6 Rear Panel	9

■ INSTALLATION

Content of the Box	11
Placing the device	11
Wiring the AES/EBU, AES/EBUid and S/P-DIF Interfaces	11
Wiring the Word Clock Interfaces	11

■ GENERAL OPERATION

Selecting Function Menus and setting Functions	13
Steps of Operation	13

■ OPERATING THE MC-6

MODE / AUDIO IN + REFERENCE Menus	15
General Operation Procedure	15
Unidirectional Format Conversion from: AES3 to AES3id, S/P-DIF optical + coaxial, AES3	16
Unidirectional Format Conversion from: AES3id to AES3, S/P-DIF optical + coaxial, AES3id	16
Unidirectional Format Conversion from: S/P-DIF optical to AES3, AES3id, S/P-DIF coaxial + optical	16
Unidirectional Format Conversion from: S/P-DIF coaxial to AES3, AES3id, S/P-DIF optical + coaxial	17
Unidirectional Format with Sampling Rate Conversion from: AES3 to AES3id, S/P-DIF optical + coaxial, AES3	17
Unidirectional Format with Sampling Rate Conversion from: AES3id to AES3, S/P-DIF optical + coaxial, AES3id	18
Unidirectional Format with Sampling Rate Conversion from: S/P-DIF optical to AES3, AES3id, S/P-DIF coaxial + optical	18
Unidirectional Format with Sampling Rate Conversion from: S/P-DIF coaxial to AES3, AES3id, S/P-DIF optical + coaxial	18
Bidirectional Format Conversion between AES3 and AES3id	19
Bidirectional Format Conversion between AES3 and S/P-DIF optical	19
Bidirectional Format Conversion between AES3 and S/P-DIF coaxial.	19
Bidirectional Format Conversion between AES3id and S/P-DIF optical.	20

Bidirectional Format Conversion between AES3id and S/P-DIF coaxial	20
Bidirectional Format Conversion between S/P-DIF optical and S/P-DIF optical	20
Bidirectional Format and Sampling Rate Conversion between AES3 and AES3id	20
Bidirectional Format and Sampling Rate Conversion between AES3 and S/P-DIF optical	21
Bidirectional Format and Sampling Rate Conversion between AES3 and S/P-DIF coaxial	21
Bidirectional Format and Sampling Rate Conversion between AES3id and S/P-DIF optical	21
Bidirectional Format and Sampling Rate Conversion between AES3id and S/P-DIF coaxial	22
Bidirectional Format and Sampling Rate Conversion between S/P-DIF optical and S/P-DIF coaxial	22
X-SRC Mode between AES3 and AES3id	22
X-SRC Mode between AES3 and S/P-DIF optical	23
X-SRC Mode between AES3 and S/P-DIF coaxial	23
X-SRC Mode between AES3id and S/P-DIF optical	24
X-SRC Mode between AES3id and S/P-DIF coaxial	24
X-SRC Mode between S/P-DIF optical and S/P-DIF coaxial	24
 STATUS	 25
REF CLOCK IN	25

APPENDIX

Pin Assignment of the Connectors	27
Switching-off the Termination of the Word Clock Input	28
Technical Data	28

Peripheral MUTEC Products

Reference Clocks and Master Clocks for Synchronization:

- **iCLOCK + iCLOCKdp**
iCLOCK and iCLOCKdp are synchronizable, high-precision clock generators which are designed to be the reference in digital audio and video studios as well as broadcast and television stations. For further details please visit:
www.iCLOCK-NET.de
- **MC-3**
The MC-3 SMART CLOCK is an universal digital audio master clock generator. The unit provides different high-stable and Ultra low-jitter clock signals for synchronization of various digital audio devices.
- **MC-3.1**
The MC-3.1 SMART CLOCK SD is an universal digital audio and SD video sync master clock generator. The unit provides different high-stable clock signals for simultaneous synchronization of digital audio and SD video devices.
- **MC-3.2**
The MC-3.2 SMART CLOCK HD is an universal digital audio and SD/HD video sync master clock generator. The unit provides different high-stable clock signals for simultaneous synchronization of digital audio and SD/HD video devices.
- **MC-2**
The MC-2 is a high-performance digital audio and reference clock signal distribution amplifier and format converter for AES3/11 and AES3/11id signals.
- **MC-7**
The MC-7 is a flexible, high-performance 8-channel Word Clock distribution amplifier and audio clock converter.

Cables for Digital Audio:

- Optical cables in different lengths from 0.5 m to 20 m for S/P-DIF and ADAT™ transfers.

For all peripheral products please have a look on our website:
www.MUTEC-NET.de!



CONTROL ELEMENTS AND TERMINALS

MC-6 Front Panel

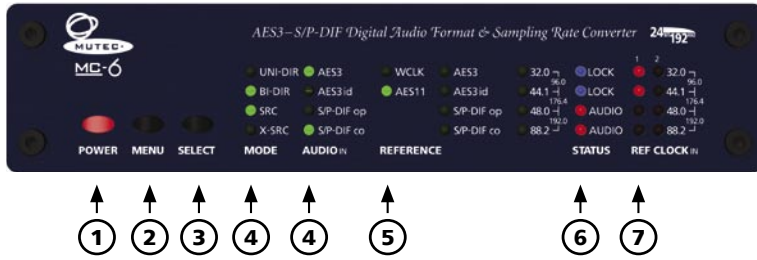

- 1 POWER**
This red LED lights up when the unit is switched on with the rear panel POWER switch.
- 2 MENU**
The push-button selects one of the available function menus.
- 3 SELECT**
Use this push-button to select a function within a specific function menu.
- 4 MODE + AUDIO IN**
This function menu allows to adjust all available conversion modes (LED line »MODE«) in combination with the corresponding digital audio formats (LED line »AUDIO IN«).
- 5 REFERENCE**
This function menu allows to select the master clock reference for synchronization of the format conversion section as well as the SRCs.
- 6 STATUS**
This menu indicates various signal statuses of the incoming master clock reference signal and the digital audio signal. For details see page 25.
- 7 REF CLOCK IN**
This menu indicates the clock rates of the incoming digital audio signal or of the master clock reference signal. For details see page 25.

Refer to the OPERATIONS chapter for more information.

MC-6 Rear Panel



- 1 AES3id OUT + WCLK OUT**
The first output above transmits an AES3id digital audio stereo signal in compliance with the AES3id-2001 standard. The second output below transmits a low-jitter Word Clock signal based on the selected external reference clock or the internal clock basis. The impedances of both connectors are 75Ω (BNC connectors, female).
- 2 S/P-DIF OUT**
These two S/P-DIF outputs, available as optical (»OP«) and coaxial (»CO«) interfaces, transmit an optical S/P-DIF and an unbalanced electrical S/P-DIF digital audio or blank frame signal in compliance with the IEC 60958 standard. The coaxial interface impedance is 75Ω (cinch connector), the optical interface offers a Toshiba Toslink™ connector, EIAJ standard.
- 3 AES3 OUT**
This AES/EBU output transmits a transformer-balanced electrical AES3 or AES11 signal in compliance with AES3-1992 (R1997) standard. The output impedance is 110Ω (XLR connector, male).

For detailed specifications on all terminals, refer to the »Pin Assignment of the Connectors« and »Technical Data« in the chapter »APPENDIX«.



INSTALLATION

Content of the Box

The unit was packed carefully. Nevertheless we recommend to check the content directly after opening the package:

- 1 x MC-6
- 1 x Power cable
- 4 x Rubber feet
- 1 x Manual
- 1 x Registration card

Placing the Device

The unit should be set up as closely as possible to the devices to which it will be connected, so as to avoid excessive cable lengths. Use the 4 rubber feet enclosed with the appliance and stick them symmetrically on the bottom side of the unit to protect the enclosure and supporting surface from being damaged.

The device can be mounted into a standard 19" rack and will require 1 unit. In this case, the rubber feet cannot be attached. Install the device so that one unit of rack space is left free both above and below the device to allow for sufficient ventilation! The mounting depth including the terminals is 160 mm/6.7". Another 60 mm/2.4" should be added for the required cables.

Additional slide-in rails on the rack inside are recommended for safe installation. This will also avoid long-term mechanical deformation of the housing.

Wiring the AES/EBU, AES/EBUId and S/P-DIF interfaces

AES/EBU

Connect the AES/EBU interfaces with the help of balanced electrical cables equipped with XLR connectors on both ends. The specifications stipulate a specific cable resistance of 110Ω (ask your retailer for a confirmation of this value when purchasing the cables).

AES/EBUId

Connect the AES/EBUId interfaces with the help of unbalanced electrical BNC cables equipped with BNC connectors on both ends (same as used for Word Clock). The specifications stipulate a specific cable resistance of 75Ω (ask your retailer for a confirmation of this value when purchasing the cables). Typically, such cables are marked »RG-59U, RG59B/U«.

S/P-DIF

Connect the coaxial S/P-DIF interfaces with help of unbalanced electrical cables equipped with cinch connectors on both ends. The specifications stipulate a specific cable resistance of 75Ω. Ask your retailer for a confirmation of this value when purchasing the cables.

Connect the optical S/P-DIF interface with the help of Toshiba TOSLINK™ compliant optical fiber cables. Here, you can use both plastic and glass fiber-based cables. When using plastic fiber cables, lengths of 10 meters should not be exceeded, so as to ensure the reliable transmission of signals. Glass fiber cables can transfer data reliably even over greater distances.

Wiring the Word Clock Interfaces

Connect the Word Clock interfaces with the help of unbalanced electrical BNC cables equipped with BNC connectors on both ends. The specifications stipulate a specific cable resistance of 75Ω (ask your retailer for a confirmation of this value when purchasing the cables). Typically, such cables are marked »RG-59U, RG59B/U«.

To allow for the synchronization of signals, the interfaces of all devices involved must be properly connected to each other, so as to ensure a logical signal flow. Always be sure to connect the Word Clock output of the MC-6 to the corresponding input of the device you wish to synchronize. Cable lengths should be kept as short as possible to minimize signal losses and/or interferences!

Before Powering Up

 The condition of the packaging material and the device should be checked carefully additionally. If there are any damages please refer to SAFETY INSTRUCTIONS, Initial Operation, and WARRANTY REGULATIONS.

Before installing the unit the section SAFETY INSTRUCTIONS located at the beginning of this manual should be read carefully.

Never expose the device and accessories to rain, moisture, direct sunlight, or excessive heat produced by radiators, heaters, or spot lights! Sufficient air circulation in the environment of the device must be ensured!

Cables for High Clock Rates

 Especially when working with high AES3/-11 or S/P-DIF clock rates well shielded electrical clock lines are imperative to avoid increased radiation! Standard cables are normally useable for clock rates up to 50.0kHz. Special shielded cable material should be used for transfer of higher clock rates.

MUTEC offers optical cables of various lengths that have been specifically tested for the transmission of S/P-DIF signals. Ask your local dealer for those cables!

Cables for Word Clock

 If a cable with a different resistance than 75Ω is used, a dramatic deterioration of the signal quality can be the result! In this case, the perfect synchronization of all devices involved could be impaired.

It is imperative that the lengths of all cables connected are largely the same, as this is the only way to ensure that all devices will be synchronized in phase (exception: cable tolerances).

We recommend using high-grade cables with a good shielding. A length of max. 10 meters (approx. 30feet) should not be exceeded!

INSTALLATION

Additionally, you should make sure that the Word Clock input to be connected to the MC-6's output have a 75Ω terminating resistor! Most Word Clock inputs allow for enabling/disabling the termination with a so-called »termination-switch«, which may be located on the outside or inside of the device.

For devices which have no termination of the Word Clock input, e.g. RME Hammerfall with Word Clock i/o, Alesis BRC or M-Audio ProFire Light-bridge, you can use an additional BNC-T piece to terminate the input. Plug the T piece with its center connector into the input of the receiving device. Then, connect the cable coming from the MC-6's Word Clock output to one of the lateral connectors, and the other connector of the BNC-T piece to a 75Ω resistor forming the BNC termination.

Basically, you should avoid »looping through« Word Clock leads by means of passive BNC-T pieces to preserve the signal quality, as level drops will be the result. If there is no other way to wire your set-up, please make sure that all Word Clock inputs (except for the last device in the chain) have their terminations disabled! In a serial Word Clock chain only the last clock input should have a termination! Never connect more than three devices in series to one output!



GENERAL OPERATION

Selecting Function Menus and setting Functions

The device is fully operated using the two toggle switches at the front panel.

- 1 Switching the MENU key toggles between different basic function menus.
- 2 Switching the SELECT key activates individual functions within one function menu.

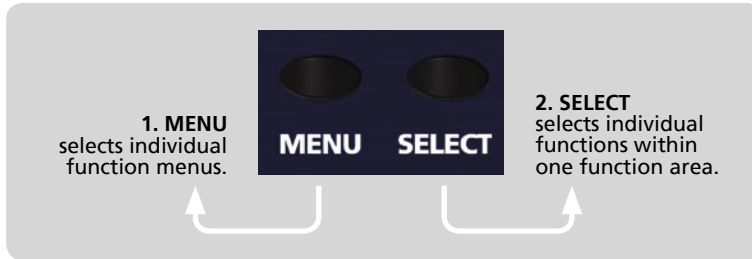

MENU + SELECT operation

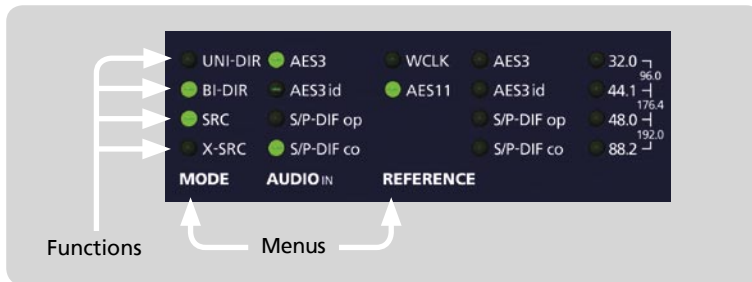

Function Areas + Functions

Steps of Operation

- 1 First press on MENU or SELECT key enables the last selected function within the last selected function menu. The corresponding LED is beginning to flash.
- 2 Every press on SELECT key will select a new function within a menu. The LED of every selected function will flash accordingly and the corresponding function is available at once.
- 3 When the needed function is selected, do not press the switches again! After a period of approx. 4 seconds the LED in front of the selected function will stop flashing.

The STATUS area is not accessible by using the MENU and SELECT switches, because it only informs about different conditions of incoming signals.

Safety Instructions

! For safety reasons, be sure to read the SAFETY INSTRUCTIONS and INSTALLATION chapters before first powering-up! We also recommend reading the CONTROL ELEMENTS AND TERMINALS chapter for information on how to connect MC-6!

! All user-specific function settings are available furthermore when power is restored.

Unidirectional Format Conversion from: AES3 to AES3id, S/P-DIF optical + coaxial, AES3

<input checked="" type="radio"/> UNI-DIR	<input checked="" type="radio"/> AES3	<input type="radio"/> WCLK	<input checked="" type="radio"/> AES3	<input type="radio"/> 32.0
<input type="radio"/> BI-DIR	<input type="radio"/> AES3id	<input type="radio"/> AES11	<input type="radio"/> AES3id	<input type="radio"/> 44.1
<input type="radio"/> SRC	<input type="radio"/> S/P-DIF op		<input type="radio"/> S/P-DIF op	<input type="radio"/> 48.0
<input type="radio"/> X-SRC	<input type="radio"/> S/P-DIF co		<input type="radio"/> S/P-DIF co	<input type="radio"/> 88.2
MODE	AUDIO IN	REFERENCE		

This setting allows to convert an AES3 source signal (see under »AUDIO IN«, »AES3«) unidirectionally (see under »MODE«, »UNI-DIR«) into AES3id, S/P-DIF optical + coaxial and AES3 simultaneously. The sampling rate will be displayed in the »REF CLOCK IN« menu. The incoming AES3 signal will be re-clocked and transferred to the format-same AES3 output. Thus, the original input signal is not lost and available for further use!

Under »REFERENCE« the »AES3« option is selected automatically. Please see the grey box on the left hand side for more information.



Why a Clock Reference for unidirectional Conversion without SRC?

To allow for e.g. the AES3 format conversion without SRC into AES3id and S/P-DIF, the MC-6 needs to derive a valid clock signal from the incoming audio source. Therefore, the corresponding reference option is activated in the »REFERENCE« menu automatically. This selection can not be changed.

Unidirectional Format Conversion from: AES3id to AES3, S/P-DIF optical + coaxial, AES3id

<input checked="" type="radio"/> UNI-DIR	<input type="radio"/> AES3	<input type="radio"/> WCLK	<input type="radio"/> AES3	<input type="radio"/> 32.0
<input type="radio"/> BI-DIR	<input checked="" type="radio"/> AES3id	<input type="radio"/> AES11	<input checked="" type="radio"/> AES3id	<input type="radio"/> 44.1
<input type="radio"/> SRC	<input type="radio"/> S/P-DIF op		<input type="radio"/> S/P-DIF op	<input type="radio"/> 48.0
<input type="radio"/> X-SRC	<input type="radio"/> S/P-DIF co		<input type="radio"/> S/P-DIF co	<input type="radio"/> 88.2
MODE	AUDIO IN	REFERENCE		

This setting allows to convert an AES3id source signal (see under »AUDIO IN«, »AES3id«) unidirectionally (see under »MODE«, »UNI-DIR«) into AES3, S/P-DIF optical + coaxial and AES3id simultaneously. The sampling rate will be displayed in the »REF CLOCK IN« menu. The incoming AES3id signal will be re-clocked and transferred to the format-same AES3id output. Thus, the original input signal is not lost and available for further use!

Under »REFERENCE« the »AES3id« option is selected automatically. Please see the grey box on the left hand side for more information.

Unidirectional Format Conversion from: S/P-DIF optical to AES3, AES3id, S/P-DIF coaxial + optical

<input checked="" type="radio"/> UNI-DIR	<input type="radio"/> AES3	<input type="radio"/> WCLK	<input type="radio"/> AES3	<input type="radio"/> 32.0
<input type="radio"/> BI-DIR	<input type="radio"/> AES3id	<input type="radio"/> AES11	<input type="radio"/> AES3id	<input type="radio"/> 44.1
<input type="radio"/> SRC	<input checked="" type="radio"/> S/P-DIF op		<input checked="" type="radio"/> S/P-DIF op	<input type="radio"/> 48.0
<input type="radio"/> X-SRC	<input type="radio"/> S/P-DIF co		<input type="radio"/> S/P-DIF co	<input type="radio"/> 88.2
MODE	AUDIO IN	REFERENCE		

This setting allows to convert an S/P-DIF optical source signal (see under »AUDIO IN«, »S/P-DIF op«) unidirectionally (see under »MODE«, »UNI-DIR«) into AES3, AES3id, S/P-DIF coaxial and S/P-DIF optical simultaneously. The sampling rate will be displayed in the »REF CLOCK IN« menu. The incoming S/P-DIF optical signal will be re-clocked and transferred to the format-same S/P-DIF optical output. Thus, the original input signal is not lost and available for further use!

Under »REFERENCE« the »S/P-DIF op« option is selected automatically. Please see the grey box on the left hand side for more information.

Unidirectional Format Conversion from: S/P-DIF coaxial to AES3, AES3id, S/P-DIF optical + coaxial

<input checked="" type="radio"/> UNI-DIR	<input type="radio"/> AES3	<input type="radio"/> WCLK	<input type="radio"/> AES3	<input type="radio"/> 32.0
<input type="radio"/> BI-DIR	<input type="radio"/> AES3id	<input type="radio"/> AES11	<input type="radio"/> AES3id	<input type="radio"/> 44.1
<input type="radio"/> SRC	<input type="radio"/> S/P-DIF op	<input type="radio"/> S/P-DIF op	<input type="radio"/> S/P-DIF op	<input type="radio"/> 48.0
<input type="radio"/> X-SRC	<input checked="" type="radio"/> S/P-DIF co	<input checked="" type="radio"/> S/P-DIF co	<input type="radio"/> S/P-DIF co	<input type="radio"/> 88.2
MODE	AUDIO IN	REFERENCE		

This setting allows to convert an S/P-DIF coaxial source signal (see under »AUDIO IN«, »S/P-DIF co«) unidirectionally (see under »MODE«, »UNI-DIR«) into AES3, AES3id, S/P-DIF optical and S/P-DIF coaxial simultaneously. The sampling rate will be displayed in the »REF CLOCK IN« menu. The incoming S/P-DIF coaxial signal will be re-clocked and transferred to the format-same S/P-DIF coaxial output. Thus, the original input signal is not lost and available for further use!

Under »REFERENCE« the »S/P-DIF co« option is selected automatically. Please see the grey box on page 16 for more information.

Unidirectional Format with Sampling Rate Conversion from: AES3 to AES3id, S/P-DIF optical + coaxial, AES3

<input checked="" type="radio"/> UNI-DIR	<input checked="" type="radio"/> AES3	<input checked="" type="radio"/> WCLK	<input type="radio"/> AES3	<input type="radio"/> 32.0
<input type="radio"/> BI-DIR	<input type="radio"/> AES3id	<input type="radio"/> AES11	<input type="radio"/> AES3id	<input type="radio"/> 44.1
<input checked="" type="radio"/> SRC	<input type="radio"/> S/P-DIF op	<input type="radio"/> S/P-DIF op	<input type="radio"/> S/P-DIF op	<input type="radio"/> 48.0
<input type="radio"/> X-SRC	<input type="radio"/> S/P-DIF co	<input type="radio"/> S/P-DIF co	<input type="radio"/> S/P-DIF co	<input type="radio"/> 88.2
MODE	AUDIO IN	REFERENCE		

External Clock References	Internal Clock Reference
------------------------------	--------------------------------

This setting allows to convert an AES3 source signal (see under »AUDIO IN«, »AES3«) unidirectionally (see under »MODE«, »UNI-DIR«) into AES3id, S/P-DIF optical + coaxial and AES3 simultaneously, as in the previous section described. Additionally to the format conversion a SRC process is added.

The sampling rate of all outputs now depends on the clock rate of the reference clock signal, which is selected in the »REFERENCE« menu. The above example shows Word Clock (»WCLK«) selected as clock reference, which is the default setting.

In this mode, the following clock references are available for synchronization of the internal SRCs:

- WCLK, 25.0kHz – 200.0kHz, SCLK 11.2896MHz + 12.288MHz
- AES11, 25.0kHz – 200.0kHz (through separate input at the rear)
- Inputs of AES3, AES3id, S/P-DIF op, S/P-DIF co, each 25.0kHz – 200.0kHz
- 32.0kHz – 192.0kHz, internal clock oscillator

To activate a clock source enter the »REFERENCE« menu and press the »SELECT« button repeatedly. When the external reference clock signal can be locked by the internal PLL circuit, the first blue LED »LOCK« in the »STATUS« menu will light constantly. The clock rate of the selected clock source is then displayed in the »REF CLOCK IN« menu with help of the first LED row, marked with »1«.



Locking so-called »Super Clocks«

Your MC-6 is able to lock to so-called »Super Clock« (SCLK) reference signals. These clock signals are used preferably for older digidesign ProTools™ MX systems. Specified are only two clock rates, 11.2896MHz + 12.288MHz which are the x256 multiple of the Word Clock rates 44.1kHz and 48.0kHz.

When locking to one of these Super Clocks, the rate will be inverted displayed in the »REF CLOCK IN« menu. Due to this, the LED in front of the corresponding base clock rate, that means Word Clock rate, does not light while all other LEDs light (see examples below).

1	2	
<input checked="" type="radio"/>	<input checked="" type="radio"/>	32.0
<input type="radio"/>	<input checked="" type="radio"/>	44.1
<input checked="" type="radio"/>	<input checked="" type="radio"/>	48.0
<input checked="" type="radio"/>	<input checked="" type="radio"/>	88.2
REF CLOCK IN		

Super Clock of 44.1kHz Word Clock

1	2	
<input checked="" type="radio"/>	<input checked="" type="radio"/>	32.0
<input checked="" type="radio"/>	<input checked="" type="radio"/>	44.1
<input type="radio"/>	<input checked="" type="radio"/>	48.0
<input checked="" type="radio"/>	<input checked="" type="radio"/>	88.2
REF CLOCK IN		

Super Clock of 48.0kHz Word Clock



Bidirectional Format Conversion between AES3 and AES3id

<input type="radio"/> UNI-DIR	<input checked="" type="radio"/> AES3	<input type="radio"/> WCLK	<input checked="" type="radio"/> AES3	<input type="radio"/> 32.0
<input checked="" type="radio"/> BI-DIR	<input checked="" type="radio"/> AES3id	<input type="radio"/> AES11	<input checked="" type="radio"/> AES3id	<input type="radio"/> 44.1
<input type="radio"/> SRC	<input type="radio"/> S/P-DIF op	<input type="radio"/> S/P-DIF op	<input type="radio"/> 48.0	<input type="radio"/> 88.2
<input type="radio"/> X-SRC	<input type="radio"/> S/P-DIF co	<input type="radio"/> S/P-DIF co	<input type="radio"/> 88.2	

MODE AUDIO IN REFERENCE

This setting is a special function of your MC-6! It allows to receive an AES3 signal and an AES3id signal simultaneously. The AES3 input signal is converted to AES3id and the AES3id input signal is converted to AES3. The other digital audio outputs are shut down.

In this mode, the MC-6 is able to work simultaneously with two different sampling rates. Therefore, the system uses two PLL synthesizers to lock the incoming AES3 and AES3id signals with their individual clock rates. The status of the PLLs is displayed in the »STATUS« and »REF CLOCK IN« menus. To distinguish between the two PLL states, you can see that generally the »LOCK« and »AUDIO« conditions of the first audio input format, seen from above of the LED row »AUDIO IN«, are displayed using the first »LOCK« and first »AUDIO« LED of the »STATUS« LED row. The status of the second audio input format is displayed accordingly with the second LEDs of this menu.

To make this more clear, the MC-6 front view below shows the assignment of the LEDs in »STATUS« and »REF COCK IN« with their numbering aligned their affiliation to the selected two digital audio formats, »AES3« (marked as »1«) and »AES3id« (marked as »2«).

<input checked="" type="radio"/> AES3	<input type="radio"/> WCLK	<input type="radio"/> AES3	<input type="radio"/> 32.0	<input checked="" type="radio"/> LOCK	<input type="radio"/> 32.0
<input checked="" type="radio"/> AES3id	<input type="radio"/> AES11	<input type="radio"/> AES3id	<input type="radio"/> 44.1	<input checked="" type="radio"/> LOCK	<input type="radio"/> 44.1
<input type="radio"/> S/P-DIF op	<input type="radio"/> S/P-DIF op	<input type="radio"/> S/P-DIF op	<input type="radio"/> 48.0	<input checked="" type="radio"/> AUDIO	<input type="radio"/> 48.0
<input type="radio"/> S/P-DIF co	<input type="radio"/> S/P-DIF co	<input type="radio"/> S/P-DIF co	<input type="radio"/> 88.2	<input checked="" type="radio"/> AUDIO	<input type="radio"/> 88.2

AUDIO IN REFERENCE STATUS REF CLOCK IN



Why a Clock Reference for bidirectional Conversion without SRC?

To allow for the bidirectional format conversion between AES3 and AES3id without SRC, the MC-6 needs to derive valid clock signals from the incoming audio sources. Therefore, the corresponding reference option is activated in the »REFERENCE« menu automatically. This selection can not be changed.

Bidirectional Format Conversion between AES3 and S/P-DIF optical

<input type="radio"/> UNI-DIR	<input checked="" type="radio"/> AES3	<input type="radio"/> WCLK	<input checked="" type="radio"/> AES3	<input type="radio"/> 32.0
<input checked="" type="radio"/> BI-DIR	<input type="radio"/> AES3id	<input type="radio"/> AES11	<input type="radio"/> AES3id	<input type="radio"/> 44.1
<input type="radio"/> SRC	<input checked="" type="radio"/> S/P-DIF op	<input type="radio"/> S/P-DIF op	<input checked="" type="radio"/> S/P-DIF op	<input type="radio"/> 48.0
<input type="radio"/> X-SRC	<input type="radio"/> S/P-DIF co	<input type="radio"/> S/P-DIF co	<input type="radio"/> S/P-DIF co	<input type="radio"/> 88.2

MODE AUDIO IN REFERENCE

This setting allows to receive an AES3 signal and a S/P-DIF optical signal simultaneously for bidirectional format conversion. The procedure is the same as described above. The sampling rates of the incoming audio signals are displayed in the »REF CLOCK IN« menus.

Bidirectional Format Conversion between AES3 and S/P-DIF coaxial

<input type="radio"/> UNI-DIR	<input checked="" type="radio"/> AES3	<input type="radio"/> WCLK	<input checked="" type="radio"/> AES3	<input type="radio"/> 32.0
<input checked="" type="radio"/> BI-DIR	<input type="radio"/> AES3id	<input type="radio"/> AES11	<input type="radio"/> AES3id	<input type="radio"/> 44.1
<input type="radio"/> SRC	<input type="radio"/> S/P-DIF op	<input type="radio"/> S/P-DIF op	<input type="radio"/> S/P-DIF op	<input type="radio"/> 48.0
<input type="radio"/> X-SRC	<input checked="" type="radio"/> S/P-DIF co	<input type="radio"/> S/P-DIF co	<input checked="" type="radio"/> S/P-DIF co	<input type="radio"/> 88.2

MODE AUDIO IN REFERENCE

This setting allows to receive an AES3 signal and a S/P-DIF coaxial signal simultaneously for bidirectional format conversion. The procedure is the same as described above. The sampling rates of the incoming audio signals are displayed in the »REF CLOCK IN« menus.



conversion. The sampling rate of the outputs now depends on the clock rate of the reference clock signal, which is selected in the »REFERENCE« menu. The example on page 20 shows Word Clock (WCLK) selected as clock reference.

In this mode, the following clock references are available for synchronization of the internal SRCs:

- WCLK, 25.0kHz – 200.0kHz, SCLK 11.2896MHz + 12.288MHz
- AES11, 25.0kHz – 200.0kHz (through separate input at the rear)
- Inputs of AES3, AES3id, S/P-DIF op, S/P-DIF co, each 25.0kHz – 200.0kHz
- 32.0kHz–192.0kHz, internal clock oscillator

To activate a clock source enter the »REFERENCE« menu and press the »SELECT« button repeatedly. When the external clock reference signal can be locked by the internal PLL circuit, the blue LED »LOCK,« in the STATUS menu will light constantly. The clock rate of the selected clock source is displayed in the »REF CLOCK IN« menu under »1«.

Bidirectional Format and Sampling Rate Conversion between AES3 and S/P-DIF optical

<input type="radio"/> UNI-DIR	<input checked="" type="radio"/> AES3	<input checked="" type="radio"/> WCLK	<input type="radio"/> AES3	<input type="radio"/> 32.0 <small>96.0</small>
<input checked="" type="radio"/> BI-DIR	<input type="radio"/> AES3id	<input type="radio"/> AES11	<input type="radio"/> AES3id	<input type="radio"/> 44.1 <small>176.4</small>
<input checked="" type="radio"/> SRC	<input checked="" type="radio"/> S/P-DIF op	<input type="radio"/> S/P-DIF op	<input type="radio"/> S/P-DIF op	<input type="radio"/> 48.0 <small>192.0</small>
<input type="radio"/> X-SRC	<input type="radio"/> S/P-DIF co	<input type="radio"/> S/P-DIF co	<input type="radio"/> S/P-DIF co	<input type="radio"/> 88.2 <small>192.0</small>
MODE	AUDIO IN	REFERENCE		

This setting allows to receive an AES3 signal and a S/P-DIF optical signal simultaneously for bidirectional format and sampling rate conversion. The procedure is the same as described above. The clock rate of the selected clock reference signal is displayed in the »REF CLOCK IN« menu under »1«.

Bidirectional Format and Sampling Rate Conversion between AES3 and S/P-DIF coaxial

<input type="radio"/> UNI-DIR	<input checked="" type="radio"/> AES3	<input checked="" type="radio"/> WCLK	<input type="radio"/> AES3	<input type="radio"/> 32.0 <small>96.0</small>
<input checked="" type="radio"/> BI-DIR	<input type="radio"/> AES3id	<input type="radio"/> AES11	<input type="radio"/> AES3id	<input type="radio"/> 44.1 <small>176.4</small>
<input checked="" type="radio"/> SRC	<input type="radio"/> S/P-DIF op	<input type="radio"/> S/P-DIF op	<input type="radio"/> S/P-DIF op	<input type="radio"/> 48.0 <small>192.0</small>
<input type="radio"/> X-SRC	<input checked="" type="radio"/> S/P-DIF co	<input type="radio"/> S/P-DIF co	<input type="radio"/> S/P-DIF co	<input type="radio"/> 88.2 <small>192.0</small>
MODE	AUDIO IN	REFERENCE		

This setting allows to receive an AES3 signal and a S/P-DIF coaxial signal simultaneously for bidirectional format and sampling rate conversion. The procedure is the same as described above. The clock rate of the selected clock reference signal is displayed in the »REF CLOCK IN« menu under »1«.

Bidirectional Format and Sampling Rate Conversion between AES3id and S/P-DIF optical

<input type="radio"/> UNI-DIR	<input type="radio"/> AES3	<input checked="" type="radio"/> WCLK	<input type="radio"/> AES3	<input type="radio"/> 32.0 <small>96.0</small>
<input checked="" type="radio"/> BI-DIR	<input checked="" type="radio"/> AES3id	<input type="radio"/> AES11	<input type="radio"/> AES3id	<input type="radio"/> 44.1 <small>176.4</small>
<input checked="" type="radio"/> SRC	<input checked="" type="radio"/> S/P-DIF op	<input type="radio"/> S/P-DIF op	<input type="radio"/> S/P-DIF op	<input type="radio"/> 48.0 <small>192.0</small>
<input type="radio"/> X-SRC	<input type="radio"/> S/P-DIF co	<input type="radio"/> S/P-DIF co	<input type="radio"/> S/P-DIF co	<input type="radio"/> 88.2 <small>192.0</small>
MODE	AUDIO IN	REFERENCE		

This setting allows to receive an AES3id signal and a S/P-DIF optical signal simultaneously for bidirectional format and sampling rate conversion. The procedure is the same as described above. The clock rate of the selected clock reference signal is displayed in the »REF CLOCK IN« menu under »1«.

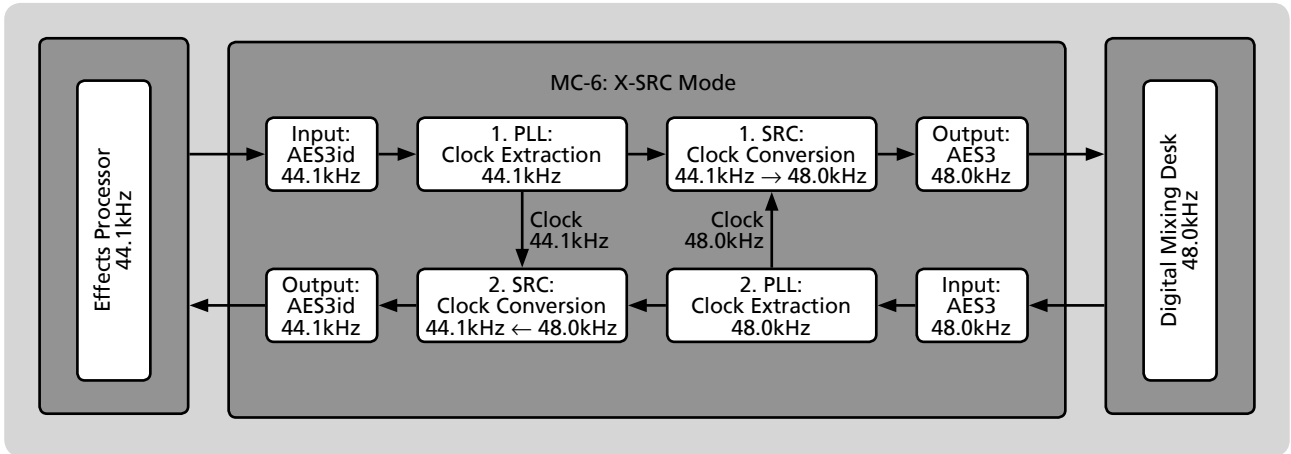

This setting allows to receive an AES3 signal and an AES3id simultaneously. The AES3 input signal is converted to AES3id and the AES3id signal is converted to the AES3. The clock rate of the incoming AES3 signal is extracted by the second PLL synthesizer and supplied as clock reference to the first SRC, which feeds the AES3 output. The clock rate of the incoming AES3id signal is extracted by the first PLL synthesizer and supplied as clock reference to the second SRC, which feeds the AES3id output.

That means, the AES3 input is predefined as clock source for the first SRC, the AES3 output. The AES3id input is predefined as clock source for the second SRC, the AES3id output. There are no other adjustments for clock sources possible within the X-SRC mode.

When the incoming digital audio signals can be locked as clock references by the PLLs, the blue LEDs »LOCK« in the STATUS menu will light constantly. The clock rate of the clock sources are displayed in the »REF CLOCK IN« menu under »1« and »2«. The identifier »1« generally indicates the sampling rate of the first digital audio format selected in the »AUDIO IN« menu, seen from above of the LED row. The identifier »2« generally indicates the sampling rate of the second digital audio format, displayed below the first one.

! Clock References for the X-SRC Modes

Using the X-SRC mode, the MC-6 extracts the needed clock rates out of the incoming digital audio signals. Thereby, the system does not need and does not accept any additional external applied clock reference signals.

X-SRC Mode between AES3 and S/P-DIF optical

<input type="radio"/> UNI-DIR	<input checked="" type="radio"/> AES3	<input type="radio"/> WCLK	<input checked="" type="radio"/> AES3	<input type="radio"/> 32.0
<input type="radio"/> BI-DIR	<input type="radio"/> AES3id	<input type="radio"/> AES11	<input type="radio"/> AES3id	<input type="radio"/> 44.1
<input type="radio"/> SRC	<input checked="" type="radio"/> S/P-DIF op	<input type="radio"/> S/P-DIF op	<input type="radio"/> S/P-DIF op	<input type="radio"/> 48.0
<input checked="" type="radio"/> X-SRC	<input type="radio"/> S/P-DIF co	<input type="radio"/> S/P-DIF co	<input type="radio"/> S/P-DIF co	<input type="radio"/> 88.2
MODE	AUDIO IN	REFERENCE		

This setting allows to receive an AES3 and S/P-DIF optical signal simultaneously for bidirectional format and sampling rate conversion using the X-SRC mode. The procedure is the same as described above.

X-SRC Mode between AES3 and S/P-DIF coaxial

<input type="radio"/> UNI-DIR	<input checked="" type="radio"/> AES3	<input type="radio"/> WCLK	<input checked="" type="radio"/> AES3	<input type="radio"/> 32.0
<input type="radio"/> BI-DIR	<input type="radio"/> AES3id	<input type="radio"/> AES11	<input type="radio"/> AES3id	<input type="radio"/> 44.1
<input type="radio"/> SRC	<input type="radio"/> S/P-DIF op	<input type="radio"/> S/P-DIF op	<input type="radio"/> S/P-DIF op	<input type="radio"/> 48.0
<input checked="" type="radio"/> X-SRC	<input checked="" type="radio"/> S/P-DIF co	<input checked="" type="radio"/> S/P-DIF co	<input type="radio"/> S/P-DIF co	<input type="radio"/> 88.2
MODE	AUDIO IN	REFERENCE		

This setting allows to receive an AES3 and S/P-DIF coaxial signal simultaneously for bidirectional format and sampling rate conversion using the X-SRC mode. The procedure is the same as described above.



STATUS

This area displays different system conditions of your MC-6. There is no access for changing settings.

»LOCK« (2X)

Doing unidirectional format conversions or bidirectional format conversions with SRC, the first »LOCK« LED above lights when the internal PLL circuit has detected the incoming digital audio signal or clock reference signal as valid. During bidirectional format conversions or the different X-SRC modes, both »LOCK« LEDs light, when the incoming digital audio signals are valid. There, the first LED above in the LED row indicates the lock status of the first selected digital audio format, the second lock LED the status of the secondly selected digital audio format.

If the digital audio signal or reference clock signal is unstable, the »LOCK« LEDs do not light, the whole audio conversion process will be stopped and the digital audio outputs do not transmit any signals.

If the internal oscillator is selected as reference clock for the SRCs, the first »LOCK« LED will light correspondingly.

»AUDIO« (2X)

These two LEDs indicate if the incoming digital audio signal is valid aligned to the processable digital audio standards (see APPENDIX). Using one of the unidirectional conversion modes, the first »AUDIO« LED, seen from above of the LED row, indicates the audio status of the digital audio reference signal. Using bidirectional modes or one of the X-SRC modes, assigned to the corresponding digital audio formats, selected within the »AUDIO IN« mode.

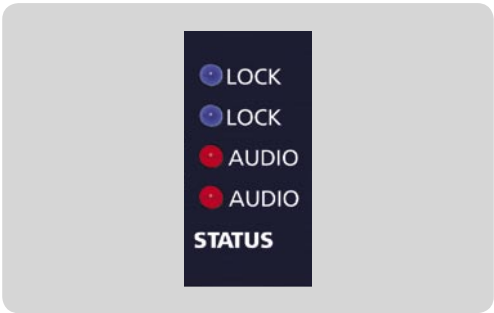

STATUS

REF CLOCK IN

»1« + »2«

This area displays the incoming sampling and reference clock rates for the different operation modes of your MC-6.

Unidirectional Format Conversion:

The sampling rate of the digital audio signal, which is selected as reference, will be displayed under LED row »1«. The LEDs of row »2« do not light.

Unidirectional Format and Sampling Rate Conversion:

The clock rate of the selected reference clock signal will be displayed under LED row »1«. The LEDs of row »2« do not light.

Bidirectional Format Conversion:

The sampling rate of the digital audio format, selected as first in the »AUDIO IN« menu, will be displayed with LED row »1«. The sampling rate of the secondly selected digital audio format is displayed with LED row »2«.

Bidirectional Format and Sampling Rate Conversion:

The clock rate of the selected reference clock signal will be displayed under LED row »1«. The LEDs of row »2« do not light.

X-SRC Mode:

The sampling rate of the digital audio format, selected as first in the »AUDIO IN« menu, will be displayed with LED row »1«. The sampling rate of the second digital audio format is displayed with LED row »2«.

If the internal reference clock oscillator is selected as clock reference, regardless of the operation mode, the clock rate selected in the »REFERENCE« menu will be displayed under LED row »1«. The LEDs of row »2« do not light.

The following basis reference clock rates are supported and will be analyzed:

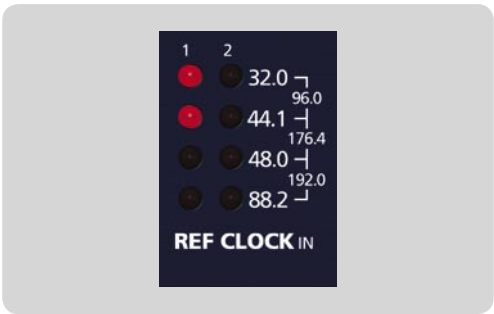

REF CLOCK IN



AES11 REFERENCE INPUT	
Interface	1 x XLR female, transformer balanced, input impedance 110Ω, 200mV–7.0V
Format, Resolution	AES11–1997/2003, AES3–1992/2003, 16–24 bits
Lock Range	25.0kHz to 200.0kHz
AES3 AUDIO OUTPUT	
Interface	1 x XLR male, transformer balanced, 3.5Vpp @ 110Ω, output impedance 110Ω, buffered
Format, Resolution	AES3–1992/2003, AES11–1997/2003, 24 bits
Transmitted Clock Rates	25.0kHz to 200.0kHz
AES3id AUDIO OUTPUT	
Interface	1 x BNC, 1.0V, unbalanced, input impedance 75Ω
Format, Resolution	AES3id–1995/2001, 24 bits
Transmitted Clock Rates	25.0kHz to 200.0kHz
S/P-DIF OPTICAL OUTPUT (OP)	
Interface	1 x Toshiba Toslink™, EIAJ RC-5720
Format, Resolution	IEC 60958, 24 bits
Transmitted Clock Rates	25.0kHz to 200.0kHz
S/P-DIF COAXIAL OUTPUT (CO)	
Interface	1 x BNC, 0.5V, unbalanced, input impedance 75Ω, buffered
Format, Resolution	IEC 60958, 24 bits
Transmitted Clock Rates	25.0kHz to 200.0 kHz
WORD CLOCK OUTPUT (WCLK)	
Interface	1 x BNC, 3,5V@22Ω, unbalanced, buffered
Transmitted Clock Rates	25.0kHz to 200.0kHz
SIGNAL PROCESSING	
Digital Audio Format Conversion	AES3, AES3id, S/P-DIF (optical + coaxial) in every combination and direction
Sampling Rate Conversion	Lock range: 25.0kHz to 200.0kHz Dynamic range: 144dB (A-weighted) Resolution: 24Bits THD+N: -140dB Input/Output sampling ratio: 1:16 (upsampling), 16:1 (downsampling)
INTERNAL REFERENCE CLOCK SPECIFICATIONS	
Oscillator Type	TCXO, temperature compensated crystal oscillator
Clock Accuracy (shipped)	<±0.5ppm
Clock Stability vs. Temperature	<±0.5ppm within -10°C to +60°C
Operating Temperature	-10°C to +60°C
Clock Jitter	<10ps (RMS)
POWER SUPPLY	
Type	Internal, switching power supply
Input Voltage	85V–264V (automatic adjustment), 47Hz–440Hz
Power Consumption	max. 10W
SYSTEM UNIT COVER	
Cover Size/Material/Color	196 x 42 x 156mm without connectors (WxHxD), aluminium sheet 1mm, black
Front Panel Size/Material	198 x 44 x 2mm (WxHxD), aluminium
Weight	~670g



WWW.MUTEC-NET.DE
FON 0049-(0)30-74 6880-0
FAX 0049-(0)30-74 6880-99