

***Pioneer***

**DJ MIXER**

# **DJM-350**

**<http://www.prodjnet.com/support/>**

The Pioneer website listed above provides answers to frequently asked questions, information about software, and other up-to-date data of assistance to our customers.

**Operating Instructions**

Thank you for buying this Pioneer product. Please read through these operating instructions so you will know how to operate your model properly. After you have finished reading the instructions, put them away in a safe place for future reference. In some countries or regions, the shape of the power plug and power outlet may sometimes differ from that shown in the explanatory drawings. However the method of connecting and operating the unit is the same.

## IMPORTANT



The lightning flash with arrowhead symbol, within an equilateral triangle, is intended to alert the user to the presence of uninsulated "dangerous voltage" within the product's enclosure that may be of sufficient magnitude to constitute a risk of electric shock to persons.

### CAUTION

**RISK OF ELECTRIC SHOCK  
DO NOT OPEN**



**CAUTION:**  
TO PREVENT THE RISK OF ELECTRIC SHOCK, DO NOT REMOVE COVER (OR BACK). NO USER-SERVICEABLE PARTS INSIDE. REFER SERVICING TO QUALIFIED SERVICE PERSONNEL.

The exclamation point within an equilateral triangle is intended to alert the user to the presence of important operating and maintenance (servicing) instructions in the literature accompanying the appliance.

D3-4-2-1-1\_A1\_En

## IMPORTANT SAFETY INSTRUCTIONS

- 1) Read these instructions.
  - 2) Keep these instructions.
  - 3) Heed all warnings.
  - 4) Follow all instructions.
  - 5) Do not use this apparatus near water.
  - 6) Clean only with dry cloth.
  - 7) Do not block any ventilation openings. Install in accordance with the manufacturer's instructions.
  - 8) Do not install near any heat sources such as radiators, heat registers, stoves, or other apparatus (including amplifiers) that produce heat.
  - 9) Do not defeat the safety purpose of the polarized or grounding-type plug. A polarized plug has two blades with one wider than the other. A grounding type plug has two blades and a third grounding prong. The wide blade or the third prong are provided for your safety. If the provided plug does not fit into your outlet, consult an electrician for replacement of the obsolete outlet.
  - 10) Protect the power cord from being walked on or pinched particularly at plugs, convenience receptacles, and the point where they exit from the apparatus.
  - 11) Only use attachments/accessories specified by the manufacturer.
  - 12) Use only with the cart, stand, tripod, bracket, or table specified by the manufacturer, or sold with the apparatus. When a cart is used, use caution when moving the cart/apparatus combination to avoid injury from tip-over.
- 
- 13) Unplug this apparatus during lightning storms or when unused for long periods of time.
  - 14) Refer all servicing to qualified service personnel. Servicing is required when the apparatus has been damaged in any way, such as power-supply cord or plug is damaged, liquid has been spilled or objects have fallen into the apparatus, the apparatus has been exposed to rain or moisture, does not operate normally, or has been dropped.

P1-4-2-2\_En

### NOTE:

This equipment has been tested and found to comply with the limits for a Class B digital device, pursuant to Part 15 of the FCC Rules. These limits are designed to provide reasonable protection against harmful interference in a residential installation. This equipment generates, uses, and can radiate radio frequency energy and, if not installed and used in accordance with the instructions, may cause harmful interference to radio communications. However, there is no guarantee that interference will not occur in a particular installation. If this equipment does cause harmful interference to radio or television reception, which can be determined by turning the equipment off and on, the user is encouraged to try to correct the interference by one or more of the following measures:

- Reorient or relocate the receiving antenna.
- Increase the separation between the equipment and receiver.
- Connect the equipment into an outlet on a circuit different from that to which the receiver is connected.
- Consult the dealer or an experienced radio/TV technician for help.

D8-10-1-2\_A1\_En

## WARNING

This equipment is not waterproof. To prevent a fire or shock hazard, do not place any container filled with liquid near this equipment (such as a vase or flower pot) or expose it to dripping, splashing, rain or moisture.

D3-4-2-1-3\_A1\_En

## WARNING

*Before plugging in for the first time, read the following section carefully.*

**The voltage of the available power supply differs according to country or region. Be sure that the power supply voltage of the area where this unit will be used meets the required voltage (e.g., 230 V or 120 V) written on the rear panel.**

D3-4-2-1-4\*\_A1\_En

## WARNING

To prevent a fire hazard, do not place any naked flame sources (such as a lighted candle) on the equipment.

D3-4-2-1-7a\_A1\_En

## WARNING

Slots and openings in the cabinet are provided for ventilation to ensure reliable operation of the product, and to protect it from overheating. To prevent fire hazard, the openings should never be blocked or covered with items (such as newspapers, table-cloths, curtains) or by operating the equipment on thick carpet or a bed.

D3-4-2-1-7b\*\_A1\_En

## Operating Environment

Operating environment temperature and humidity: +5 °C to +35 °C (+41 °F to +95 °F); less than 85 %RH (cooling vents not blocked)

Do not install this unit in a poorly ventilated area, or in locations exposed to high humidity or direct sunlight (or strong artificial light)

D3-4-2-1-7c\*\_A1\_En

If the AC plug of this unit does not match the AC outlet you want to use, the plug must be removed and appropriate one fitted. Replacement and mounting of an AC plug on the power supply cord of this unit should be performed only by qualified service personnel. If connected to an AC outlet, the cut-off plug can cause severe electrical shock. Make sure it is properly disposed of after removal. The equipment should be disconnected by removing the mains plug from the wall socket when left unused for a long period of time (for example, when on vacation).

D3-4-2-2-1a\_A1\_En

## CAUTION

The  switch on this unit will not completely shut off all power from the AC outlet. Since the power cord serves as the main disconnect device for the unit, you will need to unplug it from the AC outlet to shut down all power. Therefore, make sure the unit has been installed so that the power cord can be easily unplugged from the AC outlet in case of an accident. To avoid fire hazard, the power cord should also be unplugged from the AC outlet when left unused for a long period of time (for example, when on vacation).

D3-4-2-2-2a\*\_A1\_En

This Class B digital apparatus complies with Canadian ICES-003.

D8-10-1-3\_A1\_En

## Information to User

Alterations or modifications carried out without appropriate authorization may invalidate the user's right to operate the equipment.

D8-10-2\_A1\_En

## IMPORTANT NOTICE

THE MODEL NUMBER AND SERIAL NUMBER OF THIS EQUIPMENT ARE ON THE REAR OR BOTTOM. RECORD THESE NUMBERS ON PAGE 19 FOR FUTURE REFERENCE.

D36-AP9-1\_A1\_En\_PSV

**WARNING:** Handling the cord on this product or cords associated with accessories sold with the product may expose you to chemicals listed on proposition 65 known to the State of California and other governmental entities to cause cancer and birth defect or other reproductive harm.

***Wash hands after handling.***

D36-P5\_B1\_En

## POWER-CORD CAUTION

Handle the power cord by the plug. Do not pull out the plug by tugging the cord and never touch the power cord when your hands are wet as this could cause a short circuit or electric shock. Do not place the unit, a piece of furniture, etc., on the power cord, or pinch the cord. Never make a knot in the cord or tie it with other cords. The power cords should be routed such that they are not likely to be stepped on. A damaged power cord can cause a fire or give you an electrical shock. Check the power cord once in a while. When you find it damaged, ask your nearest PIONEER authorized service center or your dealer for a replacement.

S002\*\_A1\_En



## Dear Customer:

Selecting fine audio equipment such as the unit you've just purchased is only the start of your musical enjoyment. Now it's time to consider how you can maximize the fun and excitement your equipment offers. This manufacturer and the Electronic Industries Association's Consumer Electronics Group want you to get the most out of your equipment by playing it at a safe level. One that lets the sound come through loud and clear without annoying blaring or distortion-and, most importantly, without affecting your sensitive hearing.

Sound can be deceiving. Over time your hearing "comfort level" adapts to higher volumes of sound. So what sounds "normal" can actually be loud and harmful to your hearing. Guard against this by setting your equipment at a safe level BEFORE your hearing adapts.

### To establish a safe level:

- Start your volume control at a low setting.
- Slowly increase the sound until you can hear it comfortably and clearly, and without distortion.

### Once you have established a comfortable sound level:

- Set the dial and leave it there.

Taking a minute to do this now will help to prevent hearing damage or loss in the future. After all, we want you listening for a lifetime.

## We Want You Listening For A Lifetime

Used wisely, your new sound equipment will provide a lifetime of fun and enjoyment. Since hearing damage from loud noise is often undetectable until it is too late, this manufacturer and the Electronic Industries Association's Consumer Electronics Group recommend you avoid prolonged exposure to excessive noise. This list of sound levels is included for your protection.

### Decibel Level Example

30	Quiet library, soft whispers
40	Living room, refrigerator, bedroom away from traffic
50	Light traffic, normal conversation, quiet office
60	Air conditioner at 20 feet, sewing machine
70	Vacuum cleaner, hair dryer, noisy restaurant
80	Average city traffic, garbage disposals, alarm clock at two feet.

### THE FOLLOWING NOISES CAN BE DANGEROUS UNDER CONSTANT EXPOSURE

90	Subway, motorcycle, truck traffic, lawn mower
100	Garbage truck, chain saw, pneumatic drill
120	Rock band concert in front of speakers, thunderclap
140	Gunshot blast, jet plane
180	Rocket launching pad

Information courtesy of the Deafness Research Foundation.



S001\_A1\_En

---

---

# Contents

## How to read this manual

The names of displays, menus, and buttons in this manual are enclosed in brackets. (e.g. [MASTER] channel, [ON/OFF], [File] menu)

### 01 Before start

Features .....	6
System setup example.....	6
What's in the box.....	6

### 02 Connections

Names of terminals.....	7
Connecting the input/output terminals .....	8

### 03 Operations

Control panel .....	9
About the power switch of this unit.....	10
Basic operations (mixer section).....	10
Monitoring the sound over headphones (headphones section) .....	12
Using the effect function (master effect section) .....	12
Using a microphone or external device (MIC/AUX section) .....	12
Recording the performance (USB recording section) .....	13
About the auto standby function .....	13

### 04 Additional information

Troubleshooting .....	15
About errors.....	16
About USB devices/files usable on this unit .....	16
About the exemption clauses .....	17
Specifications.....	17

# Before start

## Features

This unit is a DJ mixer that carries over the technology of the Pioneer DJM series, the world standard in club sound. It is a standard type unit equipped with the basic functions required for mixing, enabling full-fledged DJ play easily.

### USB recording

With this unit, the sound of DJ performances can easily be recorded on USB devices (portable flash memory devices, etc.). The recorded sound can also be played on this unit.

### 3-band equalizer

This unit is equipped with a 3-band equalizer allowing the volume of the high, medium and low frequency ranges to be adjusted separately. Not only can the tone be adjusted to your tastes, the sound for a certain range can be turned completely off by turning the control all the way counterclockwise (isolator function).

### MASTER EFFECT (GATE, CRUSH, JET, FILTER)

This unit is equipped with four effect buttons allowing the sound to be changed in various ways. The mood of the sound can be modified easily, simply by pressing a button and turning the control.

### MIC/AUX INPUT

This unit is equipped with a microphone/auxiliary input allowing connection of a microphone or external device (sampler, portable audio device, etc.). DJ play is possible using up to three sets of inputs: CH-1 (channel 1), CH-2 (channel 2) and MIC/AUX (microphone/auxiliary channel).

### FADER START

When connected to a Pioneer DJ player with a control cord (included with the DJ player), playback on the DJ player can be started by operating this unit's fader (Fader Start Play).

## System setup example

A DJ system like the one shown on the diagram below can be achieved by combining this unit with a DJ player and peripheral equipment.

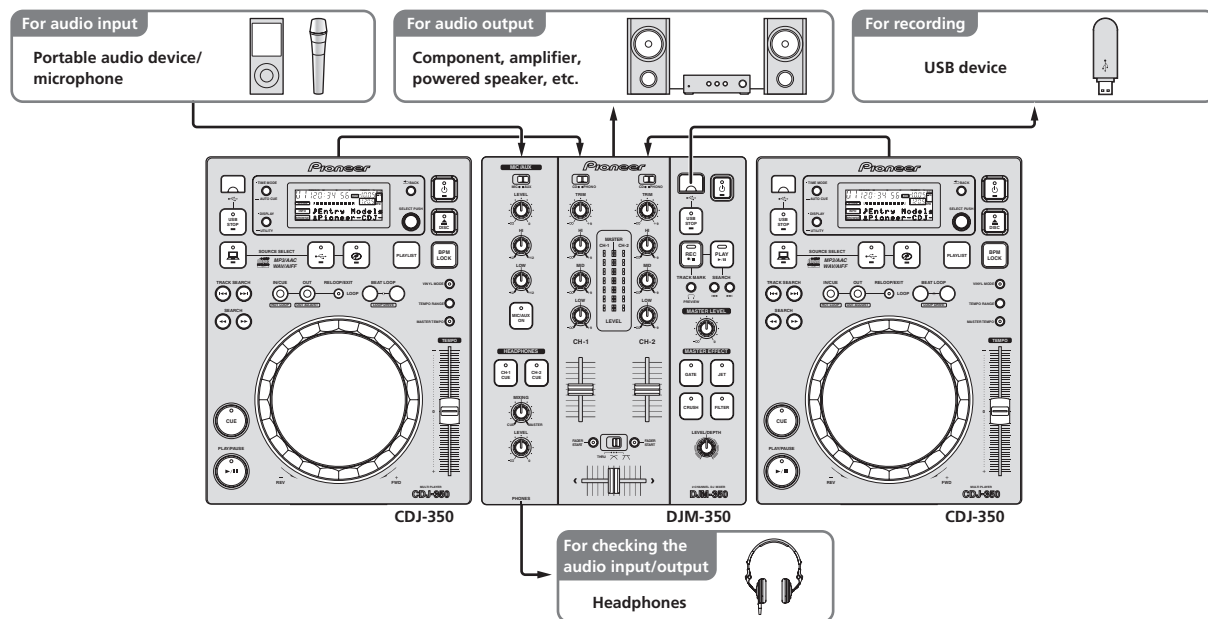

## What's in the box

- Power cable
- Operating instructions (this document)

# Connections

Be sure to turn off the power and unplug the power cord from the power outlet whenever making or changing connections. Refer to the operating instructions for the component to be connected. Connect the power cord after all the connections between devices have been completed. Be sure to use the included power cord.

## Names of terminals

### Rear panel

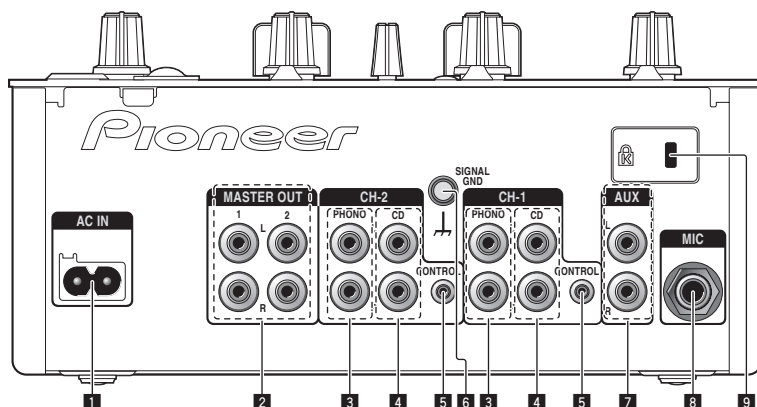

#### 1 AC IN

Connect to an AC outlet. Plug in the power cord after all connections have been made. Be sure to use the included power cord.

#### 2 MASTER OUT 1, 2 (page 8)

Connect to a power amplifier, etc.

#### 3 PHONO (page 8)

Connect to an analog player or other phono level (MM cartridge) output device. Do not connect to a DJ player or other line level device.

#### 4 CD (page 8)

Connect to a DJ player or other line level device.

#### 5 CONTROL (page 8)

Connect using a control cord (included with Pioneer DJ players).

#### 6 SIGNAL GND (page 8)

Connect an analog player's ground wire here. This helps reduce noise when the analog player is connected.

#### 7 AUX (page 8)

Connect to the output terminal of an external device (sampler, portable audio device, etc.)

#### 8 MIC (page 8)

Connect to a microphone.

#### 9 Kensington security slot

### Front panel

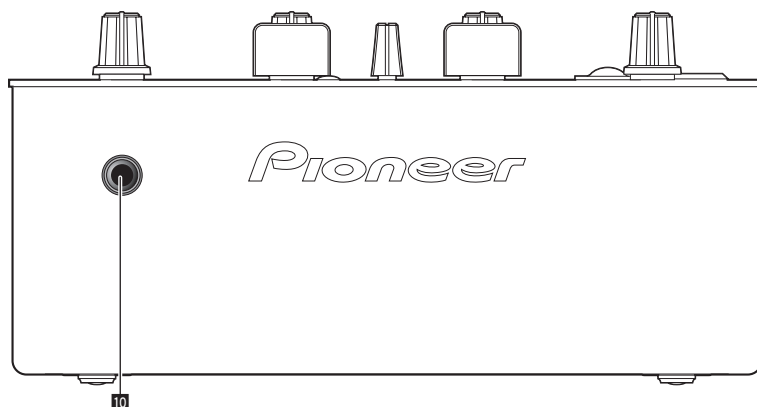

#### 10 PHONES (page 8)

Connect headphones here.

# Connecting the input/output terminals

## Rear panel

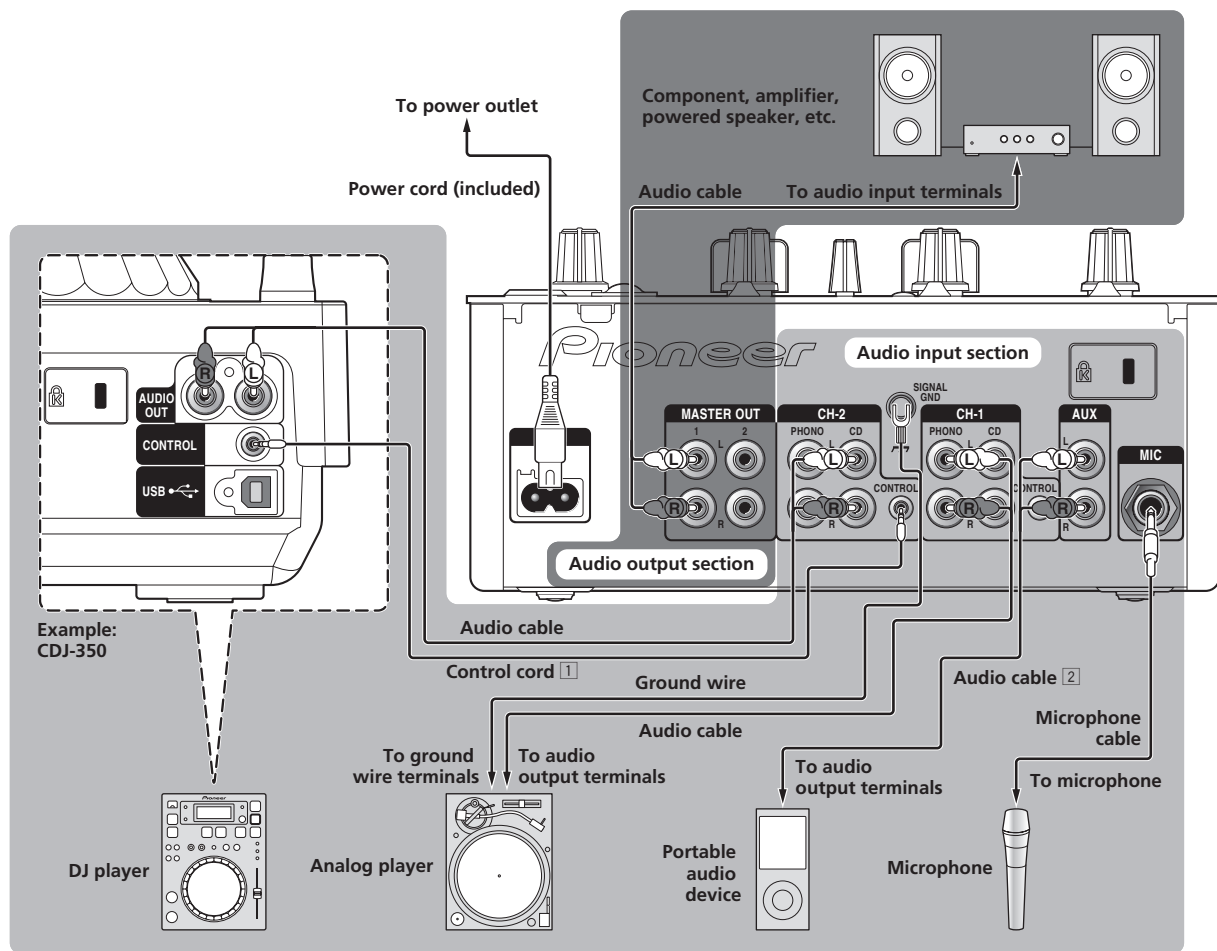

1 To use the fader start function, connect a control cord (page 11).

The fader start function can only be used when connected to a Pioneer DJ player.

2 A portable audio device can be connected using an RCA pin - mini-plug (Ø 3.5 mm) converter cable (page 12).

## Front panel

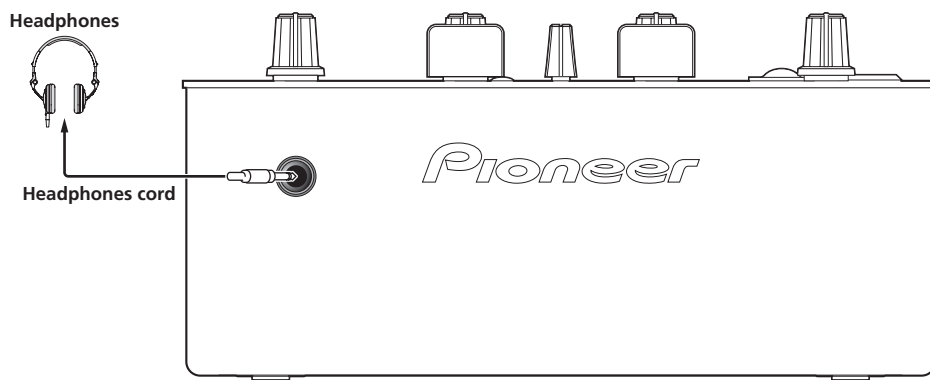



# Operations

## Control panel

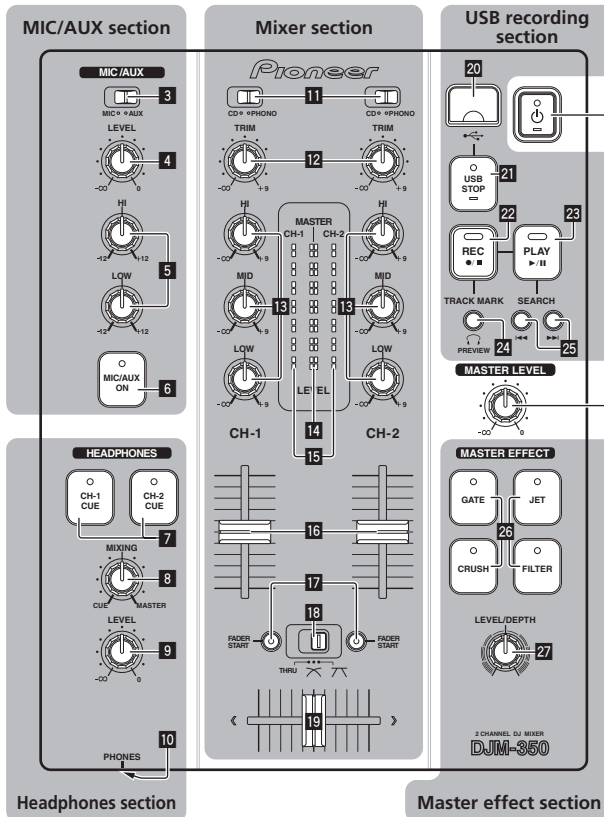

## Flow of audio signals

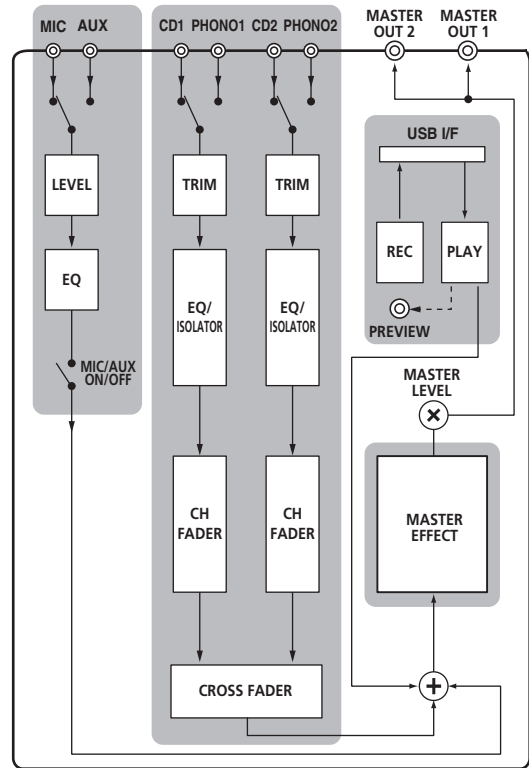

- 1 (Power switch) (page 10)
- 2 MASTER LEVEL (page 10)

## MIC/AUX section

The sound of a microphone or external device (sampler, portable audio device, etc.) can be handled (page 12).

- 3 MIC, AUX
- 4 LEVEL
- 5 HI, LOW
- 6 MIC/AUX ON

## Headphones section

The sound being input to this unit can be checked over headphones (page 12).

- 7 CH-1 CUE, CH-2 CUE
- 8 MIXING
- 9 LEVEL
- 10 PHONES

## Mixer section

Two sets of audio signals can be adjusted separately for basic DJ mixing (page 10).

- 11 CD, PHONO (input selector switch)
- 12 TRIM
- 13 HI, MID, LOW
- 14 Master level indicator
- 15 Channel level indicator
- 16 Channel fader
- 17 FADER START
- 18 THRU, (crossfader curve selector switch)
- 19 Crossfader

## USB recording section

DJ performances can be recorded onto and played from USB devices (page 13).

- 20 USB device insertion slot
- 21 USB STOP

- 22 REC ●/■
- 23 PLAY ►/⏸
- 24 TRACK MARK (PREVIEW)
- 25 SEARCH ◀◀, ▶▶

## Master effect section

Effects can be applied to the sound output from [MASTER OUT 1, 2] (page 12).

- 26 MASTER EFFECT (GATE, CRUSH, JET, FILTER)
- 27 LEVEL/DEPTH

## About the power switch of this unit

### To turn the power on

Press [⏻] **1**.

Turn on the power of this unit.  
The [⏻] indicator lights green.

### To set to the standby mode

When this unit's power is on, press [⏻] **1** for at least 2 seconds.

This unit is set to the standby mode.

The [⏻] indicator lights red.

- When [⏻] is pressed again, the power turns on.
- This unit is equipped with an auto standby function. For details, see *About the auto standby function* on page 13.

## Basic operations (mixer section)

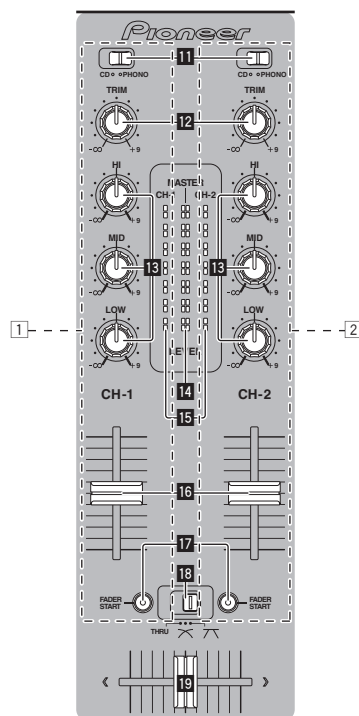

## Outputting sound

Check that this unit is properly connected to the DJ player, etc., before outputting sound. For instructions on connections, see *Connecting the input/output terminals* on page 8.

Set the volume of the power amplifiers connected to the [MASTER OUT 1, 2] terminals to an appropriate level. Note that very loud sounds will be output if the volume is set too high.

### ❖ To output the sound of channel 1 [CH-1] **1**

To output the sound of channel 2 ([CH-2]) **2**, perform the procedure below replacing [CH-1] with [CH-2].

#### 1 Switch the [CD, PHONO] (input selector) switch **1** for the [CH-1] **1**.

Select the input source for [CH-1] from among the devices connected to this unit.

- [CD]: Selects the DJ player connected to the [CD] terminals.
- [PHONO]: Selects the analog player connected to the [PHONO] terminals.

#### 2 Turn the [TRIM] **12** control for the [CH-1] **1** clockwise.

Adjusts the audio level input to the [CH-1] terminal.

The [CH-1] channel level indicator **15** lights when audio signals are being properly input to [CH-1].

Adjust [TRIM] so that the orange indicator lights at the point in the track where the volume is loudest (the climax, etc.).

Be careful that the red indicator does not light, or the sound could be distorted.

#### 3 Move the [CH-1] **1** channel fader **16** to the back side.

The level of the sound output from the [CH-1] terminals is adjusted.

#### 4 Switch [THRU, ↘, ↗] (the crossfader curve selector switch) **18**.

This switches the crossfader curve characteristics.

- [THRU]: Choose this when you do not want to use the crossfader.
- [↘]: Set here for a curve that rises gradually.

- [↖]: Set here for a curve that rises steeply. (When the crossfader moves away from either the left or right edge, the sound is immediately output from the opposite side.)

## 5 Move the crossfader 19.

Switch the channel whose sound is output from the speakers.

- Left edge: The [CH-1] sound is output.
- Center position: The sound of [CH-1] and [CH-2] is mixed and output.
- Right edge: The [CH-2] sound is output.
- This operation is not necessary when the [THRU, ↖, ↗] (crossfader curve selector) switch is set to [THRU].

## 6 Turn [MASTER LEVEL] 2 clockwise.

Sound is output from the speakers.

The master level indicator 14 on the control panel lights.

Adjust [MASTER LEVEL] so that the orange indicator lights at the point in the track where the volume is loudest (the climax, etc.).

Be careful that the red indicator does not light, or the sound could be distorted.

## Adjusting the sound quality

### Turn the [CH-1] 1 or [CH-2] 2 [HI], [MID] or [LOW] 16 control.

Refer to *Specifications* on page 17 for the range of sound that can be adjusted by each control.

- The sound for that range can be turned completely off by turning the control all the way counterclockwise (isolator function).

## Mixing using the faders

Prepare the unit in advance so that the sound of [CH-1] 1 is being output from the speakers. For instructions on preparation, see *Outputting sound* on page 10.

For instructions on monitoring the sound, see *Monitoring the sound over headphones (headphones section)* on page 12.

### ❖ Mixing using the channel faders

#### 1 Set [THRU, ↖, ↗] (the crossfader curve selection switch) 18 to [THRU].

#### 2 Switch the [CD, PHONO] (input selector) switch 11 for the [CH-2] 2.

#### 3 Turn the [TRIM] 12 control for the [CH-2] 2 clockwise.

#### 4 Press [CH-2 CUE] 7.

The sound of [CH-2] is monitored from the headphones.

#### 5 Turn [MIXING] 8.

This adjusts the balance of the monitor volume between the sound output from the [MASTER OUT 1, 2] terminals (the sound of [CH-1]) and the sound of [CH-2].

#### 6 Operate the DJ player connected to the [CH-2] terminals.

While checking the sound over the headphones, adjust the tempo of [CH-2] track to match the tempo of [CH-1] track.

#### 7 While moving the [CH-2] 2 channel fader to the back, move the [CH-1] 1 channel fader to the front.

While checking the sound output from the speakers, operate the channel faders to substitute the sound of [CH-1] with the sound of [CH-2]. Mixing is completed once only the [CH-2] sound is being output from the speakers.

### ❖ Mixing using the crossfader

#### 1 Set [THRU, ↖, ↗] (the crossfader curve selector switch) 18 to [↖] or [↗].

#### 2 Operate [CH-2] 2.

Operate as described in steps 2 to 6 under *Mixing using the channel faders* on page 11.

#### 3 Move the crossfader 19 gradually to the right.

While checking the sound output from the speakers, operate the crossfader to substitute the sound of [CH-1] with the sound of [CH-2]. Mixing is completed once only the [CH-2] sound is being output from the speakers.

## Using the fader to play a Pioneer DJ player (fader start)

If you connect a Pioneer DJ player using a control cable (supplied with a DJ player), you can start playback of control other operations of the DJ player with the fader of this unit.

The fader start function can only be used when connected to a Pioneer DJ player.

Connect this unit and Pioneer DJ player beforehand. For instructions on connections, see *Connecting the input/output terminals* on page 8.

### ❖ To start playback using the channel faders

#### 1 Set [THRU, ↖, ↗] (the crossfader curve selection switch) 18 to [THRU].

#### 2 Press [FADER START] 17.

Turn the fader start function on.

#### 3 Move the channel fader 16 all the way to the front.

#### 4 Set the cue on the DJ player.

The DJ player pauses playback at the cue point.

#### 5 Move the channel fader 16 to the back.

Playback starts on the DJ player.

- If you set the channel fader back to the original position, the player instantaneously returns to the cue point already set and pauses playback (back cue).

### ❖ To start playback using the crossfader

#### 1 Set [THRU, ↖, ↗] (the crossfader curve selector switch) 18 to [↖] or [↗].

#### 2 Press [FADER START] 17.

Turn the fader start function on.

#### 3 Move the crossfader 19.

Move the crossfader to the opposite edge from the channel for which you want to use the fader start function.

#### 4 Set the cue on the DJ player.

The DJ player pauses playback at the cue point.

#### 5 Move the crossfader 19.

Playback starts on the DJ player.

- If you set the crossfader back to the original position, the player instantaneously returns to the cue point already set and pauses playback (back cue).

## Monitoring the sound over headphones (headphones section)

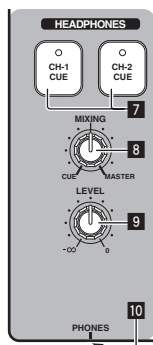

### 1 Connect headphones to the [PHONES] jack.

For instructions on connections, see *Connecting the input/output terminals* on page 8.

### 2 Press [CH-1 CUE] or [CH-2 CUE] 7.

Select the channel you want to monitor.

- [CH-1 CUE]: The sound of [CH-1] is monitored.
- [CH-2 CUE]: The sound of [CH-2] is monitored.
- This operation is not necessary to monitor the master channel sound (the sound output from the [MASTER OUT 1, 2] terminals).

### 3 Turn [MIXING] 8.

- When turned counterclockwise: The volume of [CH-1] and [CH-2] becomes relatively louder.
- At the center position: The sound of [CH-1] and [CH-2] has the same volume as the sound from the [MASTER OUT 1, 2] terminals.
- When turned clockwise: The volume of the sound output from the [MASTER OUT 1, 2] terminals becomes relatively louder.

### 4 Turn [LEVEL] 9 in the headphones section clockwise.

Sound is output from the headphones.

- Monitoring is canceled when [CH-1 CUE] or [CH-2 CUE] is pressed again.
- Monitoring of the sound output from the [MASTER OUT 1, 2] terminals cannot be canceled.

## Using the effect function (master effect section)

This unit is equipped with four effect buttons. When an effect button is pressed, the corresponding effect is applied to the audio signals output from the [MASTER OUT 1, 2] terminals.

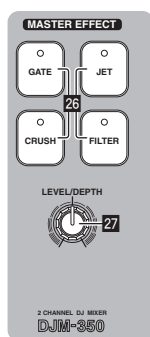

## Applying an effect

Press one of the [MASTER EFFECT (GATE, CRUSH, JET, FILTER)] 26 buttons.

The effect is applied to the sound.

The button that was pressed flashes.

The effect differs for the different buttons. For details on the different effects, see the table below.

- When a button that is flashing is pressed again, the effect is turned off.

Effect Name	Descriptions	LEVEL/DEPTH
GATE	The distinctive range is cut from the sound of the track's rhythm section to give variation to the rhythm.	Left: The high range (high hat, etc.) is given variation. Right: The low range (bass drum, etc.) is given variation.
CRUSH	The sound is moderately crushed, adding accent.	Left: The sound is crushed and an effect as if the high range was gradually cut is achieved. Right: The sound is crushed and an effect as if the low range was gradually cut is achieved.
JET	An effect like a jet ascending and descending is achieved.	Left: An effect like a jet descending is achieved. Right: An effect like a jet ascending is achieved.
FILTER	The sound of the high or low range is filtered out, greatly changing the tone.	Left: An effect as if the high range was gradually cut is achieved. Right: An effect as if the low range was gradually cut is achieved.

## Varying the effect

Turn [LEVEL/DEPTH] 27.

The effect changes according to the direction in which the [LEVEL/DEPTH] is turned and its position.

- The original sound is output when [LEVEL/DEPTH] is set to the center position.

## Using a microphone or external device (MIC/AUX section)

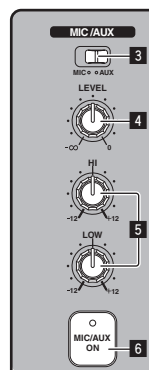

### 1 Switch [MIC, AUX] 3.

- [MIC]: The microphone connected to the [MIC] terminal is selected.
- [AUX]: The external device connected to the [AUX] terminals is selected.

### 2 Press [MIC/AUX ON] 6.

### 3 Turn [LEVEL] 4 in the MIC/AUX section clockwise.

The sound of the microphone or external device is output from the speakers.

## Adjusting the sound quality

### Turn [HI] or [LOW] 5 in the MIC/AUX section.

Refer to *Specifications* on page 17 for the range of sound that can be adjusted by each control.

## Recording the performance (USB recording section)

The same sound as the sound being output from the [MASTER OUT 1, 2] terminals can be recorded as a WAV file on a USB device.

- The name of the files created when the sound is recorded is in the format [REC\*\*\*.WAV] (\*\*\*) is a 3-digit number).

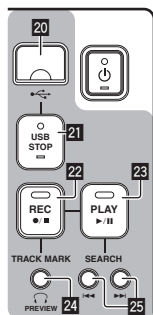

### 1 Insert the USB device into the USB device insertion slot 20.

The [USB STOP] indicator 21 flashes. After a while, the [USB STOP] indicator stops flashing, remaining lit, and the recording standby mode is set.

### 2 Press [REC ●/■] 22.

Recording starts.

The [REC ●/■] indicator 22 flashes.

- When [REC ●/■] is pressed again, the [REC ●/■] indicator turns off and recording stops.
- Continuous recording is possible for 180 minutes. If recording continues for over 180 minutes, the recording data on the USB device is automatically split.
- Recording is possible for about 90 minutes on a 1 GB USB device.

## Playing recorded tracks

### Press [PLAY ►/||] 23.

Playback starts.

The [PLAY ►/||] indicator 23 lights.

- When [PLAY ►/||] is pressed again, playback is paused.
- Only WAV files stored in the [PIONEER DJM / DJM350 REC] folder on the USB device can be played.

## Previewing recorded tracks

### 1 Turn [MIXING] 8 counterclockwise from the center position.

### 2 Press and hold in [TRACK MARK (PREVIEW)] 24.

The sound of the recorded track can be heard over the headphones while the button is pressed.

- The sound being previewed is added to the sound of [CH-1] and [CH-2] and output from the headphones.
- The sound being previewed is not output from the speakers.

- Previewing is not possible while the track is being recorded or played.

## Fast-forwarding/reversing recorded tracks

### During playback, press and hold in [SEARCH ◀◀, ▶▶] 25.

The track is fast-forwarded when [▶▶] is pressed and held in.

The track is fast reversed when [◀◀] is pressed and held in.

The [PLAY ►/||] indicator flashes during fast-forwarding/reversing.

- Fast-forwarding/reversing is not possible when in the pause mode.

### ❖ Cueing to the beginning of recorded tracks

#### Press [SEARCH ◀◀, ▶▶] 25.

Press the [▶▶] to move to the beginning of the next track.

Press [◀◀] once to move to the beginning of the currently playing track, twice to move to the beginning of the previous track.

## Splitting tracks while recording

### During recording, press [TRACK MARK (PREVIEW)] 24.

The currently recording track is split and stored on the USB device.

- When split tracks are played on this unit, the sound may be interrupted at the boundary between the two tracks.

## Deleting recorded tracks

### 1 While playing the track, press [PLAY ►/||] 23.

The track you want to delete is paused.

### 2 Press [PLAY ►/||] 23 for at least 2 seconds.

The [REC ●/■] indicator flashes.

### 3 While pressing [PLAY ►/||] 23, press [REC ●/■] 22.

The [REC ●/■] indicator lights and the track is deleted.

- Track deleting is canceled if [PLAY ►/||] is released while the [REC ●/■] indicator is flashing.

## Disconnecting USB devices

Always perform the following procedure to disconnect USB devices. Pulling the USB device out without performing this procedure could make the USB device unreadable.

When turning the set's power off, be sure to remove the USB device first.

### 1 Press [USB STOP] 21 for at least 1 second.

The [USB STOP] indicator flashes, then turns off.

### 2 Disconnect the USB device.

## About the auto standby function

When the auto standby function is turned on, the power is automatically set to the standby mode after the set time has passed with all of the conditions below met.

- That none of this unit's buttons or controls are operated.
- That this unit's channel level indicator is not lit.
- That the USB device's recording and playback functions are not in use.

## Setting the auto standby function

First set this unit to the standby mode.

### 1 Press [⏻] **1** while pressing [⏪] and [⏩] **25**.

This unit switches to the mode for changing the auto standby function's setting.

The topmost point on the master level indicator flashes. The other points on the indicator light according to the currently set time.

### 2 Press [⏪] or [⏩] **25**.

Set the time until the standby mode is set.

The set time switches each time the button is pressed.

The points on the master level indicator light according to the set time (not including the topmost point).

- Off — 20 minutes — 40 minutes — 60 minutes
- 20 minutes: The bottom two points light.
- 40 minutes: The bottom four points light.
- 60 minutes: The bottom six points light.
- The time is set to 20 minutes upon shipment from the factory.

### 3 Press [⏻] **1** for at least 2 seconds.

The new auto standby function setting is saved.







The [⏻] indicator flashes green while the setting is being saved, then stops flashing, remaining lit, once the setting has been saved.

- Do not disconnect the power cord while the setting is being saved.

# Additional information

## Troubleshooting

- Incorrect operation is often mistaken for trouble or malfunction. If you think that there is something wrong with this component, check the points below. Sometimes the trouble may lie in another component. Inspect the other components and electrical appliances being used. If the trouble cannot be rectified after checking the items below, ask your nearest Pioneer authorized service center or your dealer to carry out repair work.
- This unit may not operate properly due to static electricity or other external factors. In this case, normal operation may be restored by unplugging the power cord, waiting about 5 seconds or more, then plugging the power cord back in.

Problem	Check	Remedy
The power is not turned on.	Is the power cord properly connected?	Plug in the power cord to an AC outlet. (page 8)
No sound or small sound.	Is the [CD, PHONO] (input selector) switch set to the proper position?	Switch the [CD, PHONO] (input selector) switch to select the input source for that channel. (page 10)
	Are the [TRIM], [channel fader], [crossfader] and [MASTER LEVEL] controls set to the proper positions?	Set the [TRIM], [channel fader], [crossfader] and [MASTER LEVEL] controls to the proper positions. (page 10)
	Are the connected components, amplifiers, etc., properly set?	Set the external input selection, volume, etc., on the components/amplifiers properly.
	Are the connection cables properly connected?	Connect the connection cables properly. (page 8)
	Are the terminals and plugs dirty?	Clean the terminals and plugs before making connections.
Distorted sound.	Is [MASTER LEVEL] set at the proper position?	Adjust [MASTER LEVEL] so that the orange indicator on the master level indicator lights at the peak level. (page 10)
	Is [TRIM] set at the proper position?	Adjust [TRIM] so that the orange indicator on the channel level indicator lights at the peak level. (page 10)
Can't crossfade.	Is the [THRU,  ,  <td>Set the [THRU, ,  </td>	Set the [THRU,  , 
Can't fader start a DJ player.	Is [FADER START] set to off?	Set [FADER START] to on. (page 11)
	Is the control cord properly connected?	Connect this unit and DJ player with a control cord. (page 8)
	Are the audio cables properly connected?	Connect this unit to the audio output terminal of a DJ player with an audio cable. (page 8)
No effect.	Has one of the [MASTER EFFECT (GATE, CRUSH, JET, FILTER)] buttons been pressed?	Press one of the [MASTER EFFECT (GATE, CRUSH, JET, FILTER)] buttons. (page 12)
No sound is produced or the sound is faint when playing a track recorded on a USB device.	Is [LEVEL/DEPTH] set to the center position?	Turn [LEVEL/DEPTH] clockwise or counterclockwise. (page 12)
	Is [MASTER LEVEL] set at the proper position?	Before recording, adjust [MASTER LEVEL] so that the orange indicator on the master level indicator lights at the peak level. (page 10)
Sound is distorted when playing a track recorded on a USB device.	Is [TRIM] set at the proper position?	Before recording, adjust [TRIM] so that the orange indicator on the channel level indicator lights at the peak level. (page 10)
The sound of a recorded track cannot be previewed over the headphones even when [TRACK MARK (PREVIEW)] is pressed and held.	Is [MIXING] turned all the way clockwise?	Turn [MIXING] counterclockwise from the center position. (page 13)
USB device is not recognized.	Is the USB device properly connected?	Insert the USB device securely all the way in. (page 13)
	Is the USB device one that can be used on this unit?	This unit supports such USB mass storage class USB devices as external hard disks and portable flash memory devices.

## About errors

If this unit cannot operate normally, the [⏻] (the power switch), [USB STOP] and [PLAY ►/II] indicators flash to indicate an error.

Check the table below and take the measures indicated.

If the same error is indicated after the measures have been taken, contact your store of purchase or nearby Pioneer service station.

## About the [USB STOP] indicator's error indication

### ❖ If the [USB STOP] indicator flashes repeatedly 2 to 5 times

#### 1 Disconnect the USB device.

#### 2 Press [USB STOP].

Check the table below and take the measures indicated.

Indicator name	Number of times indicator flashes	Description of error	Cause	Measure
USB STOP	2 times repeatedly	File format problem	USB device is not formatted. You are using a USB device with a file system that is not supported by this unit.	Use a USB device formatted with a file system supported by this unit (FAT or HFS+).
	3 times repeatedly	USB class problem	A device other than a USB mass storage class device is connected.	Connect a USB mass storage class USB device.
			A USB hub is connected.	Do not connect USB hubs.
			Not enough free space on the USB device.	Use a USB device with sufficient free space.
	4 times repeatedly	Problem writing on the USB device	There is a file name "REC999.WAV" in the recorded data storage folder (PIONEER DJM / DJM350 REC).	Files created through recording are given a 3-digit number. Once the number 999 is reached, no new files can be created in the folder. If this happens, move the files in the folder to a different folder.
			USB device's write protect switch is set to the on position.	Set the USB device's write-protect switch to the off position.
			You are using a USB device with a security function.	Use a USB device without a security function.
			The recorded data storage folder (PIONEER DJM / DJM350 REC) is set to "Read Only".	Change the setting so that the recorded data storage folder is writable.
	5 times repeatedly	USB device over-current detected	You are using a USB device (such as a bus power-driven hard disk) whose current is higher than this unit's rated current (500 mA).	Use a USB device within this unit's rated current (such as a hard disk driven by an AC adapter or other external power supply).
	PLAY ►/II	3 times	Playback error	There are no playable files in the recorded data storage folder (PIONEER DJM / DJM350 REC).
⏻ (power switch)	Continuous	Circuit problem	There is a problem in the internal circuitry.	Unplug this unit's power cord from the power outlet.

## About USB devices/files usable on this unit

This unit supports external hard disks, portable flash memory devices and other USB mass storage class devices.

Folder layers	Max. 2 layers (PIONEER DJM / DJM350 REC)
Max. number of files	Maximum 999 tracks
Supported file systems	FAT, FAT32 and HFS+

- Optical disk type devices such as external DVD/CD drives, etc., are not supported.
- When there are many folders or files, some time may be required for loading.
- If multiple partitions are set for the USB device, the device may not be recognized.

- USB hubs cannot be used.
- USB devices equipped with flash card readers may not operate.
- It may happen that, when a current stronger than the maximum allowable current is detected in this unit's USB port, the [USB STOP] indicator flashes 5 times, the power supply to the USB device is cut off, and communications with the USB device are interrupted. To restore normal operation, disconnect the USB device from this unit, then press [USB STOP]. Avoid reusing USB devices for which an excess current has been detected. If normal operation is not restored (if communications cannot be established) after the above procedure is performed, try turning off this unit's power then turning it back on.
- Depending on the USB device you are using, the desired performance may not be achieved.

## About WAV files

The DJM-350 supports WAV files in the formats shown below.

Compatible formats	Files in 16-bit non-compressed PCM format with a sampling frequency of 44.1 kHz are supported.
File extension	.WAV or .wav

## Cautions on using USB devices

- Some USB devices may not operate properly. Please note that Pioneer will accept no responsibility whatsoever for loss of data recorded on USB devices.



---

---

## About the exemption clauses

- Pioneer is a registered trademark of Pioneer Corporation.
- The names of companies and products mentioned herein are the trademarks of their respective owners.
- When playing music files you have acquired on this unit, we kindly ask you to respect copyrights.

---

---

## Specifications

### General

Power requirements.....	AC 120 V, 60 Hz
Power consumption .....	17 W
Power consumption (standby).....	0.4 W
Main unit weight.....	3.2 kg (7.1 lb)
Max. dimensions.....	218 mm (W) × 107 mm (H) × 301 mm (D) (8.6 in. (W) × 4.2 in. (H) × 11.9 in. (D))
Tolerable operating temperature.....	+5 °C to +35 °C (+41 °F to +95 °F)
Tolerable operating humidity.....	5 % to 85 % (no condensation)

### Audio Section

Sampling rate.....	48 kHz
A/D, D/A converter.....	24 bits
Frequency characteristic	
<b>CD/AUX/MIC</b> .....	20 Hz to 20 kHz
S/N ratio (rated output)	
<b>CD</b> .....	97 dB
<b>PHONO</b> .....	86 dB
<b>MIC</b> .....	80 dB
Total harmonic distortion ( <b>CD — MASTER1</b> ) .....	0.007 %
Standard input level / Input impedance	
<b>CD</b> .....	-12 dBu/36 kΩ
<b>PHONO</b> .....	-52 dBu/47 kΩ
<b>MIC</b> .....	-52 dBu/10 kΩ
<b>AUX</b> .....	-12 dBu/27 kΩ
Standard output level / Load impedance / Output impedance	
<b>MASTER OUT</b> .....	+2 dBu/10 kΩ/2.5 Ω
<b>PHONES</b> .....	+2 dBu/32 Ω/150 Ω
Rated output level / Load impedance	
<b>MASTER OUT</b> .....	+18 dBu/10 kΩ
Crosstalk ( <b>CD</b> ) .....	78 dB
Channel equalizer characteristic	
<b>HI</b> .....	-∞ to +9 dB (13 kHz)
<b>MID</b> .....	-∞ to +9 dB (1 kHz)
<b>LOW</b> .....	-∞ to +9 dB (70 Hz)
MIC/AUX equalizer characteristics	
<b>HI</b> .....	-12 dB to +12 dB (10 kHz)
<b>LOW</b> .....	-12 dB to +12 dB (100 Hz)

### Input/output terminals

<b>CD</b> input terminal	
RCA pin jack .....	2 sets
<b>PHONO</b> input terminal	
RCA pin jack .....	2 sets
<b>MIC</b> input terminal	
Phone jack (∅ 6.3 mm) .....	1 set
<b>AUX</b> input terminal	
RCA pin jack.....	1 sets
<b>MASTER</b> output terminal	
RCA pin jack.....	2 sets
<b>PHONES</b> output terminal	
Stereo phone jack (∅ 6.3 mm) .....	1 set
<b>USB</b> terminal	
Type A.....	1 set
<b>CONTROL</b> terminal	
Mini phone jack (∅ 3.5 mm).....	2 sets

- The specifications and design of this product are subject to change without notice.





# Pioneer Electronics(USA) Inc.

## Limited Warranty

### WARRANTY PERIOD

For the period specified below from the date of original purchase (the warranty period), Pioneer Electronics(USA) Inc. (Pioneer) warrants that the products described below, if purchased directly from Pioneer or from an authorized Pioneer dealer or distributor in the United States and installed and operated according to operating instructions enclosed with the unit, will be repaired or replaced with a unit of comparable value, at the option of Pioneer, without charge to you for parts or labor for actual repair work if such products fail to function properly under normal use due to a manufacturing defect. Parts supplied under this warranty may be new or rebuilt at the option of Pioneer.

PRODUCTS COVERED	MODEL PREFIX	WARRANTY PERIOD	
		Parts	Labor
DJ Compact Disc Player	CDJ, CMX .....	1 YEAR	1 YEAR
DJ DVD Player	DVJ .....	1 YEAR	1 YEAR
Digital Media Player	DMP .....	1 YEAR	1 YEAR
DJ Mixer	DJM .....	1 YEAR	1 YEAR
DJ Effector	EFX .....	1 YEAR	1 YEAR
Video Switcher	VSW .....	1 YEAR	1 YEAR

This warranty covers the product during the warranty period whether in the possession of the original owner or any subsequent owner.

### WHAT'S NOT COVERED

This warranty does not cover the A-B Cross Fader in the DJ Mixer (model prefix DJM). This warranty does not cover any appearance item, any damage to the product resulting from alterations, modifications not authorized in writing by Pioneer, accident, misuse or abuse, damage due to lightning or to power surges or personal injury due to excessive sound pressure levels. This warranty does not cover the cost of parts or labor which would be otherwise provided without charge under this warranty, obtained from any source other than a Pioneer Authorized Service Company or other designated location. This warranty does not cover defects or damage caused by the use of unauthorized parts or labor, or from improper maintenance.

**PRODUCTS WITH ALTERED, DEFACED OR REMOVED SERIAL NUMBERS SHALL VOID THIS WARRANTY.**

### YOUR RIGHTS

**SOME STATES DO NOT ALLOW THE EXCLUSION OR LIMITATION OF INCIDENTAL OR CONSEQUENTIAL DAMAGES, SO THE FOLLOWING LIMITATIONS OR EXCLUSIONS MAY NOT APPLY TO YOU.**

**THE ABOVE WARRANTIES ARE IN LIEU OF AND EXCLUDE ALL OTHER WARRANTIES, EXPRESSED OR IMPLIED, INCLUDING WITHOUT LIMITATION IMPLIED WARRANTIES OF MERCHANTABILITY AND FITNESS FOR ANY PARTICULAR PURPOSE. IN NO EVENT SHALL PIONEER BE LIABLE FOR INCIDENTAL OR CONSEQUENTIAL DAMAGES ARISING OUT OF LOSS OF USE OR CLAIMS ASSERTED ON THE BASIS OF TORT (INCLUDING NEGLIGENCE), CONTRACT, OR OTHERWISE.**

### TO OBTAIN SERVICE

Pioneer has appointed a number of Authorized Industrial Service Companies throughout the U.S.A. should your product ever require service. To receive warranty service you will need to present your sales receipt or, if rented, your rental contract showing place and date of original purchase transaction.

Should it become necessary to ship the unit, you will need to package the product and send it, transportation prepaid, to an Authorized Service Company in the U.S.A. Carefully package the product using adequate padding material to prevent damage in transit. The original container is ideal for this purpose. Include in the package your name, address, telephone number where you can be reached during business hours, a copy of your sales receipt, and a detailed description of the problem.

To find the name and address of the nearest Pioneer Authorized service location, to obtain warranty service or for additional information about this warranty, please call or write:

PIONEER ELECTRONICS(USA) INC.  
CUSTOMER SUPPORT DIVISION  
P.O. BOX 1760  
LONG BEACH, CALIFORNIA 90801-1760  
1-800-872-4159

**DO NOT RETURN ANY PRODUCT TO ABOVE ADDRESS. IT IS NOT A SERVICE LOCATION.**

**TO ORDER REPLACEMENT PARTS CALL 800-228-7221**

RECORD THE PLACE AND DATE OF PURCHASE FOR FUTURE REFERENCE

Model No. \_\_\_\_\_ Serial No. \_\_\_\_\_ Purchase Date \_\_\_\_\_

Purchased From \_\_\_\_\_

KEEP THIS INFORMATION AND YOUR SALES RECEIPT IN A SAFE PLACE

To register your product, find the nearest authorized service location, to purchase replacement parts, operating instructions, or accessories, please go to one of following URLs :

Pour enregistrer votre produit, trouver le service après-vente agréé le plus proche et pour acheter des pièces de rechange, des modes d'emploi ou des accessoires, reportez-vous aux URL suivantes :

**In the USA/Aux Etats-Unis**

<http://www.pioneerelectronics.com>

**In Canada/Aux Canada**

<http://www.pioneerelectronics.ca>

S018\_B1\_EnFr

Published by Pioneer Corporation.  
Copyright © 2010 Pioneer Corporation.  
All rights reserved.

---

**PIONEER CORPORATION**

1-1, Shin-ogura, Saiwai-ku, Kawasaki-shi, Kanagawa 212-0031, Japan

**PIONEER ELECTRONICS (USA) INC.**

P.O. BOX 1540, Long Beach, California 90801-1540, U.S.A. TEL: (800) 421-1404

**PIONEER ELECTRONICS OF CANADA, INC.**

300 Allstate Parkway, Markham, Ontario L3R 0P2, Canada TEL: 1-877-283-5901, 905-479-4411

K002\_PSV\_CU

Printed in

<DRB1502-D>

