

# ALLEN & HEATH



## USER GUIDE

Publication AP8810



# CONTENTS

Thank you for purchasing your Allen & Heath XB-10 mixer. To ensure that you get the maximum benefit from the unit please spare a few minutes familiarizing yourself with the controls and setup procedures outlined in this user guide. For further information please refer to the additional information available on our web site, or contact our technical support team.

<http://www.allen-heath.com>

<http://www.allen-heath.com/xb>

Warranty .....	4
Packed Items.....	5
Safety Instructions.....	6
Panel Drawings.....	8
Introduction to XB-10.....	9
Specifications .....	11
Dimensions .....	13
Block Diagram.....	14
Mono Input Channel.....	15
TELCO Channel .....	18
Stereo Input Channels.....	21
Outputs.....	23
Output Selection .....	24
Master Section .....	25
Remote Interface Connector .....	27
Connecting to a Computer.....	29
Application Diagram - Self Op.....	30
Application Diagram - Studio.....	31
Application tip : VOIP caller .....	32
Wiring notes.....	33
Product Support .....	34

## **Limited One Year Warranty**

This product is warranted to be free from defects in materials or workmanship for period of one year from the date of purchase by the original owner.

To ensure a high level of performance and reliability for which this equipment has been designed and manufactured, read this User Guide before operating. In the event of a failure, notify and return the defective unit to ALLEN & HEATH Limited or its authorised agent as soon as possible for repair under warranty subject to the following conditions

### **Conditions Of Warranty**

The equipment has been installed and operated in accordance with the instructions in this User Guide.

The equipment has not been subject to misuse either intended or accidental, neglect, or alteration other than as described in the User Guide or Service Manual, or approved by ALLEN & HEATH.

Any necessary adjustment, alteration or repair has been carried out by ALLEN & HEATH or its authorised agent.

This warranty does not cover fader wear and tear.

The defective unit is to be returned carriage prepaid to ALLEN & HEATH or its authorised agent with proof of purchase.

Units returned should be packed to avoid transit damage.

In certain territories the terms may vary. Check with your ALLEN & HEATH agent for any additional warranty which may apply.



This product complies with the European Electromagnetic Compatibility directive 2004/108/EC and the European Low Voltage directive 2006/95/EC.

This product has been tested to EN55103 Parts 1 & 2 2009 for use in Environments E1, E2, E3, and E4 to demonstrate compliance with the protection requirements in the European EMC directive 2004/108/EC. During some tests the specified performance figures of the product were affected. This is considered permissible and the product has been passed as acceptable for its intended use. Allen & Heath has a strict policy of ensuring all products are tested to the latest safety and EMC standards. Customers requiring more information about EMC and safety issues can contact Allen & Heath.

NOTE: Any changes or modifications to the console not approved by Allen & Heath could void the compliance of the console and therefore the users authority to operate it.

Allen & Heath XB-10 User Guide AP8810 Issue 2

Copyright © 2012 Allen & Heath Limited. All rights reserved

Allen & Heath Limited

Kernick Industrial Estate, Penryn, Cornwall, TR10 9LU, UK

<http://www.allen-heath.com>

# PACKED ITEMS

Check that you have received the following:

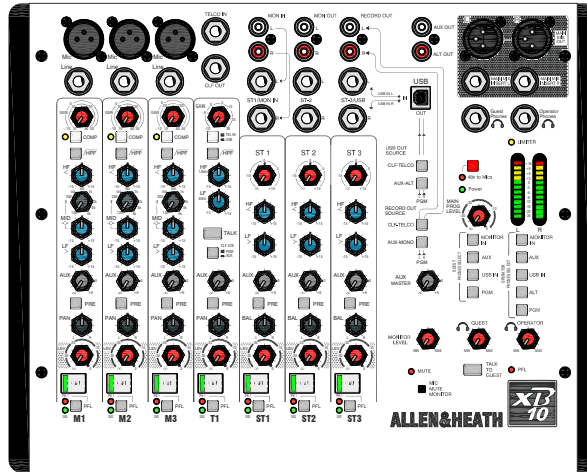

**XB-10 MIXER**

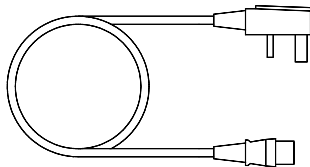

**Mains Lead (or leads)**

Check that the correct mains plug is fitted.



**This User Guide**

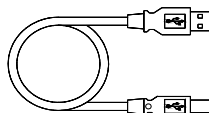

**Type A-B USB Lead**

To connect the XB-10 to your computer.

# SAFETY INSTRUCTIONS

**WARNING** - Read the following before proceeding :



**ATTENTION: RISQUE DE CHOC ELECTRIQUE – NE PAS OUVRIR**

**Read instructions:** Retain these safety and operating instructions for future reference. Adhere to all warnings printed here and on the console. Follow the operating instructions printed in this User Guide.

**Do not remove cover:** Operate the console with its covers correctly fitted.

**Power sources:** Connect the console to a mains power unit only of the type described in this User Guide and marked on the rear panel. Use the power cord with sealed mains plug appropriate for your local mains supply as provided with the console. If the provided plug does not fit into your outlet consult your service agent for assistance.

**Power cord routing:** Route the power cord so that it is not likely to be walked on, stretched or pinched by items placed upon or against it.

**Grounding:** Do not defeat the grounding and polarisation means of the power cord plug. Do not remove or tamper with the ground connection in the power cord.



**WARNING: This equipment must be earthed.**

**Water and moisture:** To reduce the risk of fire or electric shock do not expose the console to rain or moisture or use it in damp or wet conditions. Do not place containers of liquids on it which might spill into any openings.

**Ventilation:** Do not obstruct the ventilation slots or position the console where the air flow required for ventilation is impeded. If the console is to be operated in a rack unit or flightcase ensure that it is constructed to allow adequate ventilation.

**Heat and vibration:** Do not locate the console in a place subject to excessive heat or direct sunlight as this could be a fire hazard. Locate the console away from any equipment which produces heat or causes excessive vibration.

**Servicing:** Switch off the equipment and unplug the power cord immediately if it is exposed to moisture, spilled liquid, objects fallen into the openings, the power cord or plug become damaged, during lightning storms, or if smoke, odour or noise is noticed. Refer servicing to qualified technical personnel only.

**Installation:** Install the console in accordance with the instructions printed in this User Guide. Do not connect the output of power amplifiers directly to the console. Use audio connectors and plugs only for their intended purpose.

# SAFETY INSTRUCTIONS

## Important Mains plug wiring instructions

The console is supplied with a moulded mains plug fitted to the AC mains power lead. Follow the instructions below if the mains plug has to be replaced. The wires in the mains lead are coloured in accordance with the following code:



TERMINAL		WIRE COLOUR	
		European	USA/Canada
L	LIVE	BROWN	BLACK
N	NEUTRAL	BLUE	WHITE
E	EARTH GND	GREEN & YELLOW	GREEN

The wire which is coloured Green and Yellow must be connected to the terminal in the plug which is marked with the letter E or with the Earth symbol. This appliance must be earthed.

The wire which is coloured Blue must be connected to the terminal in the plug which is marked with the letter N.

The wire which is coloured Brown must be connected to the terminal in the plug which is marked with the letter L.

Ensure that these colour codes are followed carefully in the event of the plug being changed.

## General Precautions:

**Damage :** To prevent damage to the controls and cosmetics avoid placing heavy objects on the control surface, scratching the surface with sharp objects, or rough handling and vibration.

**Environment :** Protect from excessive dirt, dust, heat and vibration when operating and storing. Avoid tobacco ash, smoke, drinks spillage, and exposure to rain and moisture. If the console becomes wet, switch off and remove mains power immediately. Allow to dry out thoroughly before using again.

**Cleaning :** Avoid the use of chemicals, abrasives or solvents. The control panel is best cleaned with a soft brush and dry lint-free cloth. The faders, switches and potentiometers are lubricated for life. The use of electrical lubricants on these parts is not recommended. The fader and potentiometer knobs may be removed for cleaning with a warm soapy solution. Rinse and allow to dry fully before refitting them.

**Transporting :** The console may be transported as a free-standing unit or mounted in a rack or flightcase. Protect the controls from damage during transit. Use adequate packing if you need to ship the unit.

**Hearing :** To avoid damage to your hearing do not operate any sound system at excessively high volume. This applies particularly to close-to-ear monitoring such as headphones and in-ear systems. Continued exposure to high volume sound can cause frequency selective or wide range hearing loss.



# PANEL DRAWINGS

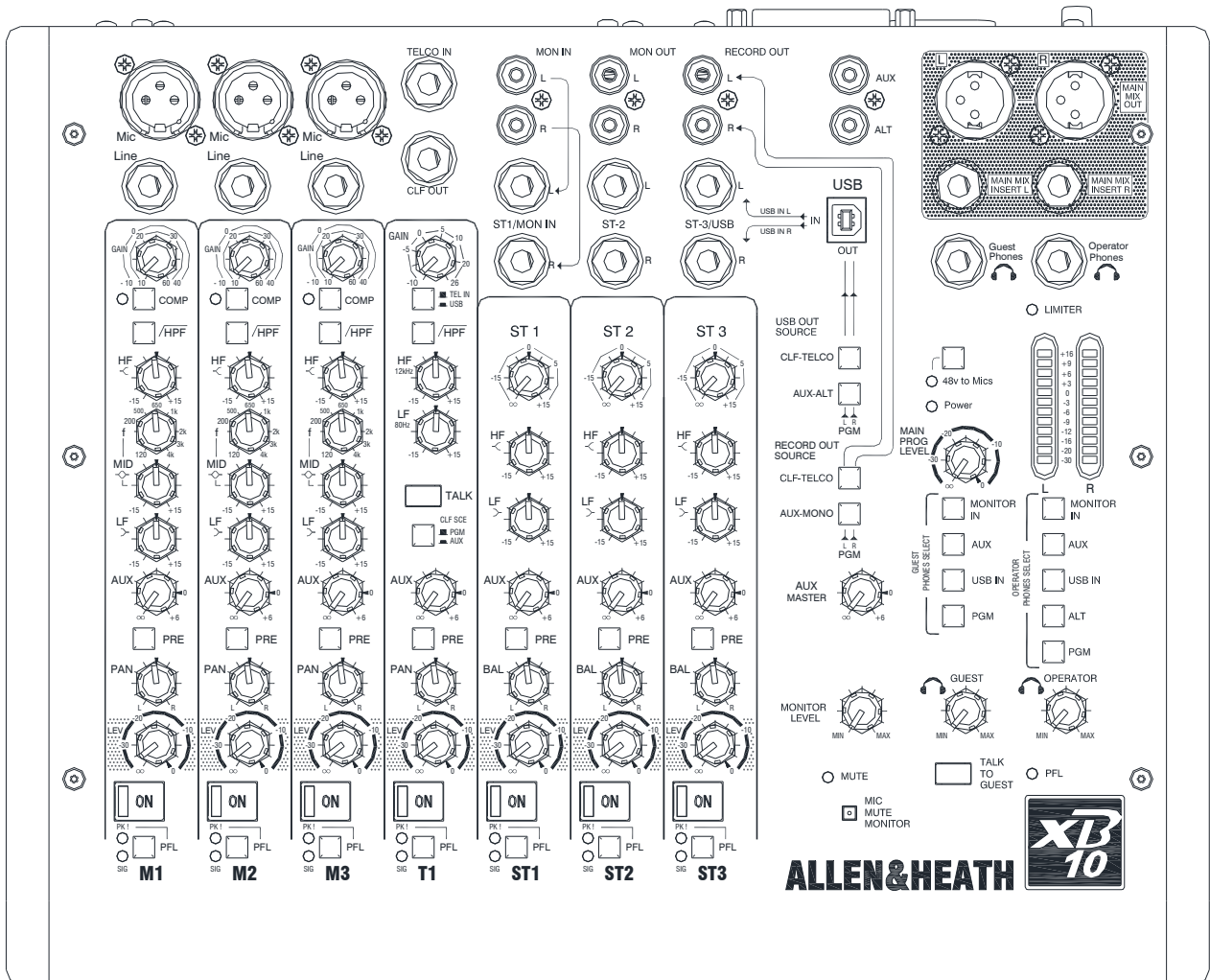
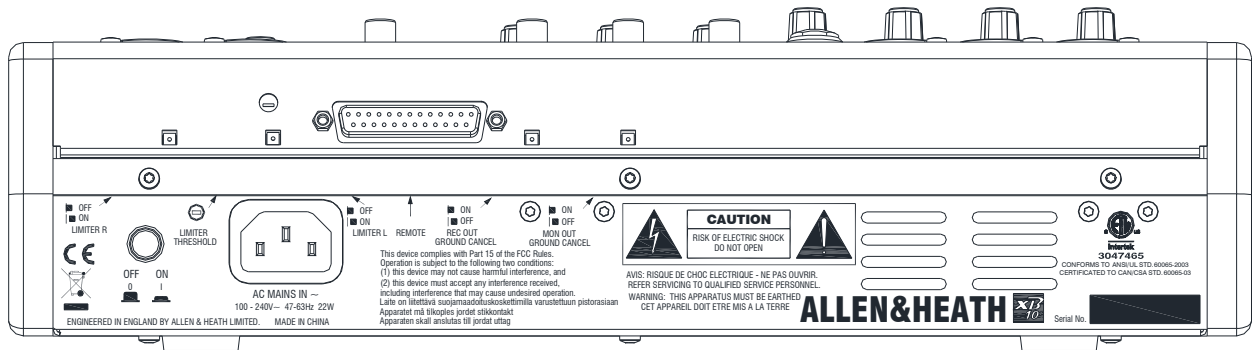



# INTRODUCTION TO THE XB-10

## Background overview

The Allen & Heath XB-10 mixer has been carefully and lovingly designed in the beautiful county of Cornwall in the UK and is manufactured alongside a wide range of professional audio mixing consoles. Many of the components used in the XB-10 are exactly the same as in the larger Allen & Heath products and the construction methods are also very similar — utilising individual vertically mounted channel circuit boards with each rotary control fixed with a metal nut to the front panel. This provides a very robust product that will resist damage and give years of reliable use. It also makes servicing much easier should it be required, with the ability to remove one particular channel from the mixer at a time.

The audio circuitry is based on years of continual development and refinement, the performance of all the elements within the mixer scrutinised and perfected to ensure the very best sound quality possible.

## Multi-application:

The XB-10 is great for a range of applications from small radio or internet broadcast studios, or for larger studios with multiple rooms, for hospital radio, university radio and community radio broadcast applications. The XB-10 has a wealth of features specifically designed for broadcasters, things like a dedicated telco channel for telephone callers, mic channel on switch sensing for switching external equipment and internal automatic muting of the speaker outputs, stereo channel start/cue outputs for CD deck transport control, separate headphones mix & outputs for a guest, built in mic compressors and output limiters.... The list goes on!

## Mic/Line Pre-amps:

Based on the pre-amps from the Mixwizard series, The XB-10 pre-amps use low noise discrete transistor circuitry to achieve high gain (60dB max), low noise and good linearity.

## Compressors

Each mic channel has its own compressor to constrain the dynamic range from the microphone inputs if required. Low level signals are given a gain boost. Mid level signals are mildly compressed with a soft knee response. High level signals are limited. This automatic compression is activated with a simple switch and indicator LED to show the level of compression.

## EQ

The XB-10 is equipped with a 3-band equaliser circuit on each mono input and a 2-band EQ on the Telco & stereo channels. The frequency and response of each has been carefully chosen to give the maximum performance when using the EQ on a variety of sources.

## Output Limiter

The main outputs on the XB-10 are equipped with a variable limiter to ensure that the final mix to air does not exceed a pre defined level. Back panel option switches allow the limiter to be selected or bypassed. A trim pot is used to vary the threshold. There is also an LED on the front panel that indicates when the limiter has triggered.

## Telco channel

The XB-10 has a dedicated TELCO input channel with a mix-minus return feed. The mix-minus feed can be sent from the main program mix or using a separate aux mix. There is a talk button where an off-air conversation can be held with the caller using a user selected comms mic channel.

By Selecting the USB input, the telco channel can be used directly from the USB connection and callers can be accessed via Skype or similar VOIP applications. This means the use of costly hybrid units, that would normally be used to connect to the telephone system, can be avoided.

## AUX / ALT bus

The XB-10 has 2 mono buses that can be used for external processing, effects, recording or auditioning.

## Remote Control

The XB-10 has a 25 way D connector on its rear panel to allow a number of extra functions.

The mic and telco channels have ON switch logic that can be used to remotely control external equipment, they can also be muted from an external "cough" switch or similar.

The stereo channels have start and cue logic outputs that can be used to operate external equipment such as CD players. Power for remote circuitry is also available on the rear panel and a post-fade program output is available for metering.

# INTRODUCTION TO THE XB-10

## **USB**

Getting audio to and from a computer easily is now a common requirement for sound and music production and broadcast applications. The way we have implemented this on XB-10 is super-flexible and super-easy! No longer do you need to fiddle around the back of your computer to get to the soundcard inputs, only to find that the levels are all wrong and noisy. Just plug in a USB lead to your XB-10, select the USB routing on the mixer and the device on your computer and that's it! Quality audio to and from your PC or MAC.

The USB connection can be used for VOIP telephone calls, Recording program material, playing jingles etc.

## **Guest Headphones**

The XB-10 has a dedicated headphone socket for studio guests with its own routing matrix. Guests can be fed the main program mix or a bespoke mix via the AUX bus. There is also a talk button to communicate off air via the user selected comms mic channel.

## **Output Matrix**

Both the operator and guest headphone outputs have an output matrix with additive feeds. This means that the operator could, for example, listen to a mix of the main program feed and an external monitor input.

## **Electronically Balanced Outputs**

The main program outputs are from XLRs with an electronically balanced output circuit. The phono outputs have a ground cancelled earth return to ensure low noise and provide some isolation from equipment with a noisy earth such as laptop computers.

## **Self operation or Producer operated:**

Whether you need a mixer for a self operated broadcast situation, or whether you have a separate studio and engineer, the XB-10 has the features to fit. Separate monitor mixes can be created for operator and guests or presenter so the engineer can check levels and cue sources while the presenter or guest can listen to a different source. The engineer/producer can communicate to the guest or presenter using the Talk feature, as well as off-air communication to telephone callers.

There is also the facility for remote control of channel mutes from the studio using the remote interface connectors, ideal for studio situated mute switches.

# SPECIFICATIONS

<b>Operating Levels</b>	
<b>Input</b>	
Mono channel Mic input (XLR)	-10 to -60dBu for nominal (+11dBu in max)
Mono channel Line input (TRS Jack socket)	+10 to -40dBu (+30dBu maximum)
Stereo input (TRS Jack sockets)	0dBu nominal (control = Off to +15dB)
Stereo input (RCA phono sockets)	0dBu nominal (control = Off to +15dB)
Telco channel input (TRS)	+10 to -26dBu (+30dBu maximum)
External monitor input (RCA phono sockets)	0dBu Nominal
<b>Output</b>	
PGM L & R outputs (XLR)	+4dBu nominal. +25dBu maximum.
PGM L & R inserts (TRS jack sockets)	-2dBu nominal. +21dBu maximum
Aux output (RCA phono socket)	0dBu nominal. +21dBu maximum.
Alt output (RCA phono socket)	0dBu nominal. +21dBu maximum.
Rec outputs (RCA phono sockets)	0dBu nominal. +21dBu maximum.
Telco cleanfeed output (TRS Jack socket)	0dBu nominal. +21dBu maximum.
CRM Speaker outputs (RCA phono sockets)	0dBu nominal. +21dBu maximum.

<b>THD+n</b>	
Mic in to PGM L/R Out, 15dB gain, 1kHz, +10dBu out	0.002%
Mic in to PGM L/R Out, 30dB gain, 1kHz, 0dBu out	0.006%
Line in to PGM L/R out, 0dB gain, 1kHz, 0dBu out	0.005%
Telco in to PGM L/R out, 0dB gain, 1kHz, 0dBu out	0.004%
Stereo in to PGM out, 0dB gain, 1kHz, +10dBu out	0.002%

<b>USB Audio CODEC (Coder/Decoder)</b>	
USB Audio In/Out	USB 1.1 compliant 16bit.
Sample Rate	32, 44.1, or 48kHz

<b>Noise</b>	
Mic Pre EIN @ max gain 150R input Z 22-22kHz	-126dBu
PGM out, PGM fader = 0, 22-22kHz	-103dBu
Aux out, Alt out, Rec out = 0, 22-22kHz	< -93dBu

# SPECIFICATIONS

<b>Headroom</b>	
Analogue Headroom from nominal (0Vu) Outputs	21 dB
Analogue Headroom from nominal (0Vu) Mix point	24dB
USB in & out headroom from nominal (0Vu)	14dB

<b>Crosstalk &amp; Attenuation (dB 22-22kHz)</b>	
Mono fader attenuation (dB relative to +10dBu) 1kHz/10kHz	-88/-88
Mono ON switch attenuation (dB relative to +10dBu) 1kHz/10kHz	-98/-98
TELCO fader attenuation (dB relative to +10dBu) 1kHz/10kHz	-90/-90
TELCO ON switch attenuation (dB relative to +10dBu) 1kHz/10kHz	-98/-98
Stereo fader attenuation (dB relative to +10dBu) 1kHz/10kHz	-86/-86
Stereo ON switch attenuation (dB relative to +10dBu) 1kHz/10kHz	-99/-96
PGM fader attenuation (dB relative to +10dBu) 1kHz/10kHz	-87/-87
TELCO clean-feed isolation from I/P (dB relative to +10dBu) 1kHz/10kHz	-94/-77
Stereo separation, L in to PGM R out. dB 1kHz/10kHz	-75/-74

<b>Frequency Response</b>	
Mic in to PGM L/R Out, 30dB gain	+0.5/-1dB 10Hz to 30kHz
Line in to PGM L/R out 0dB gain	+0.5/-1dB 10Hz to 20kHz
Stereo in to PGM L/R out	+0.5/-1dB 10Hz to 30kHz

# Dimensions

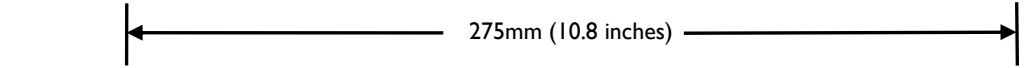
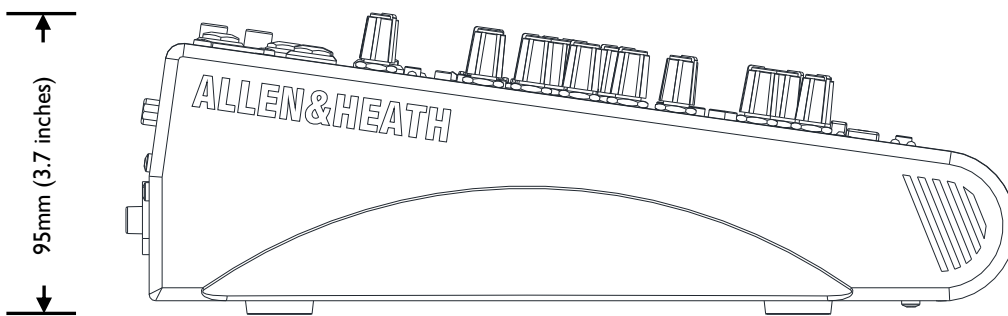
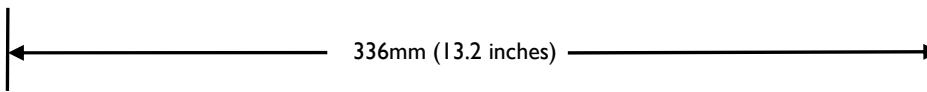
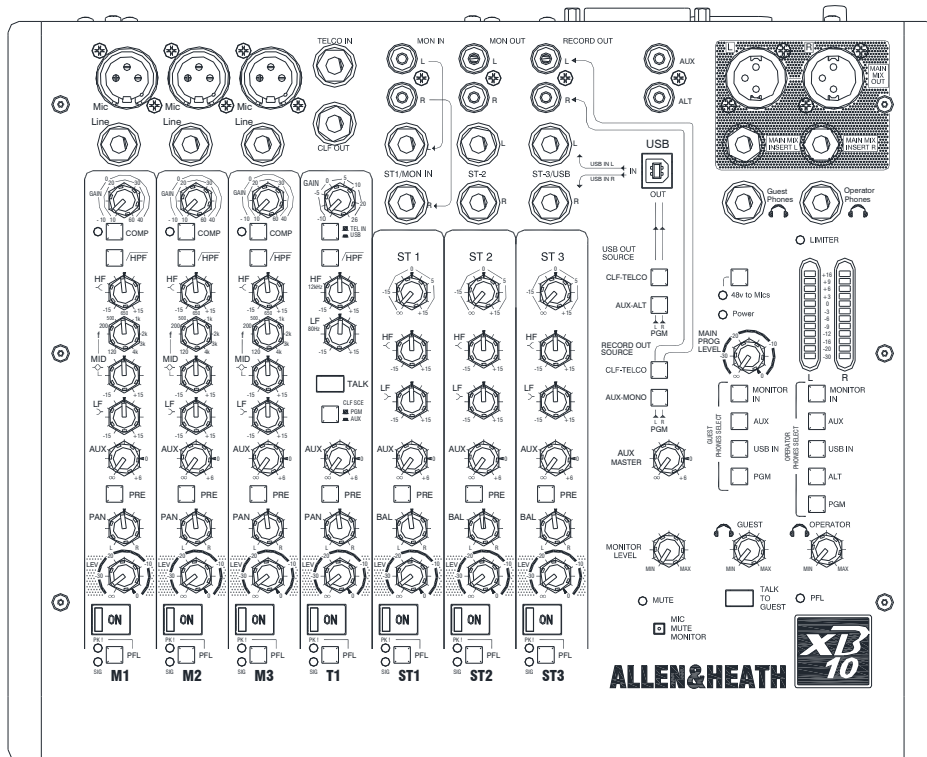

Weight	
	XB-10
Unpacked	3.4 kg (7.5 lb)
Packed	4.6 kg (10.1 lb)

A rack mounting kit is available for XB-10. The part number is: XB-10-RK19

# BLOCK DIAGRAM

## XB-10 BLOCK DIAGRAM

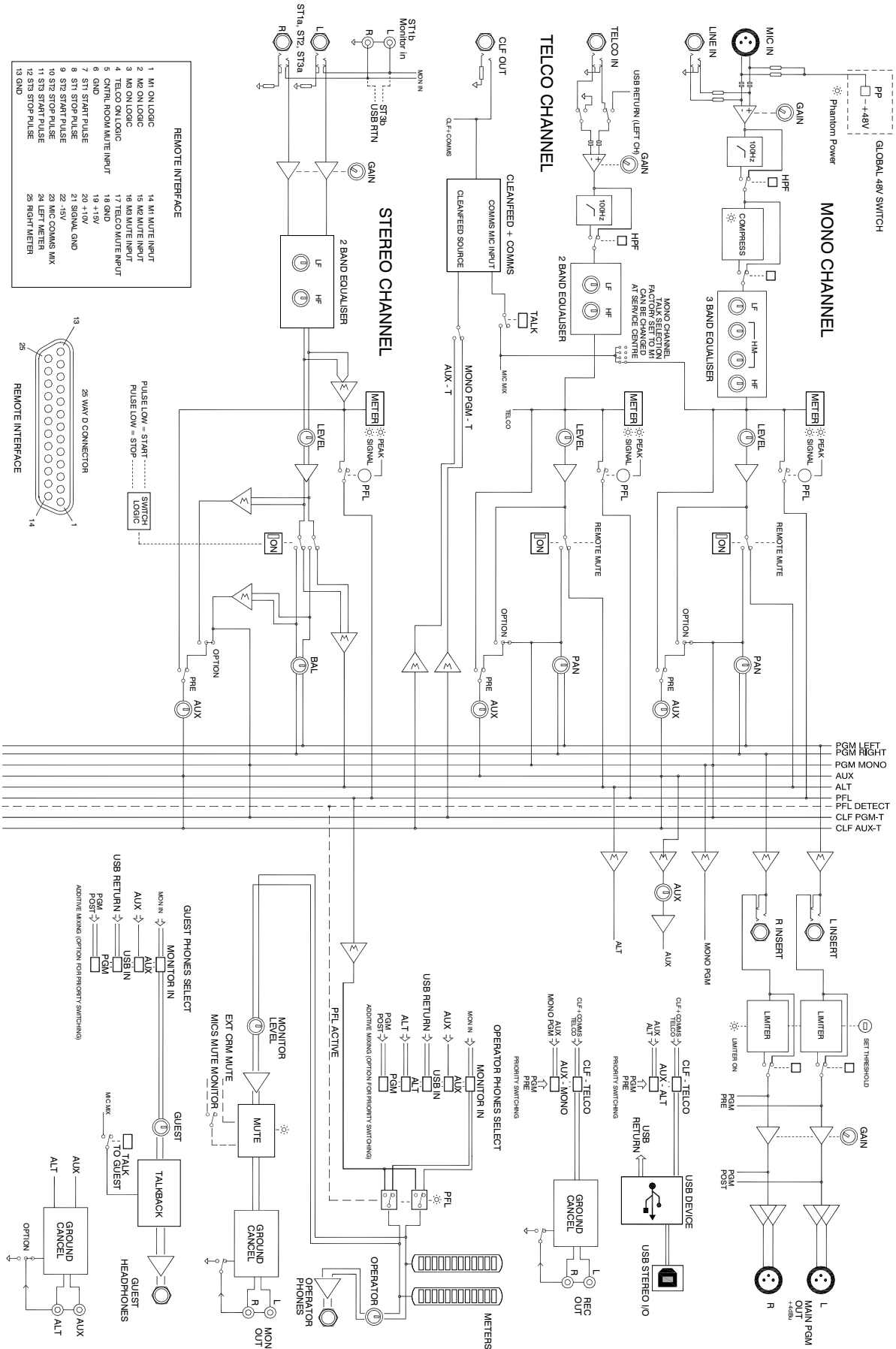

# MONO INPUT CHANNEL



## Mic Input Socket

Standard 3-Pin XLR socket wired as Pin 1=Chassis, Pin 2=hot (+), Pin 3=Cold (-).

## Line Input Jack Socket

Standard 1/4" (6.25mm) Jack socket for balanced or unbalanced line level signals. Wired Tip=Hot(+), Ring=cold (-), Sleeve=Chassis. The Line input connects to the XLR input via a pad, so be aware that the two signals will add together if both inputs are plugged in simultaneously.

## Gain Control

This adjusts the gain of the input amplifier to match the signal level of the source. The gain is varied from +10dB to +60dB for signals plugged in to the XLR socket (Mic Input) and -10dB to +40dB for signals plugged into the Line input jack.

## Compressor

This enables the compressor which is optimised to reduce the dynamic range of a presenter microphone. Low level signals are given a 10dB gain boost, Soft knee compression activates at -20dBu. Higher level signals are limited.

The LED gives an indication of the amount of compression by modulating with the signal level.

## 100Hz Hi-pass Filter

The Hi-pass filter is used for reducing pop noise and rumble from microphone signals. It is a 2-pole filter with a corner frequency set at 100Hz.

The filter affects signals from both Mic XLR and Line jack socket.

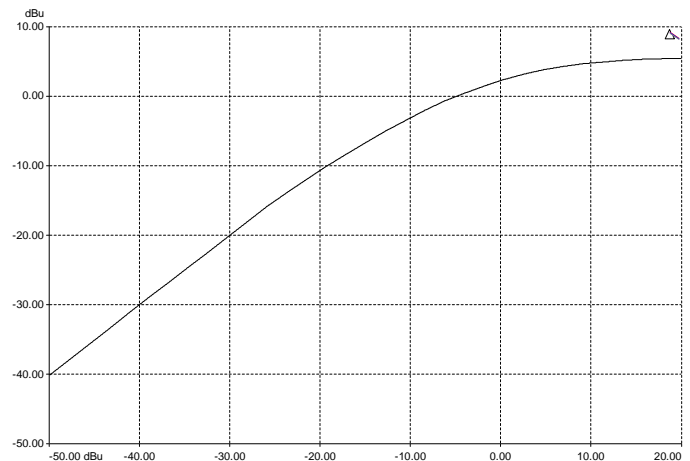
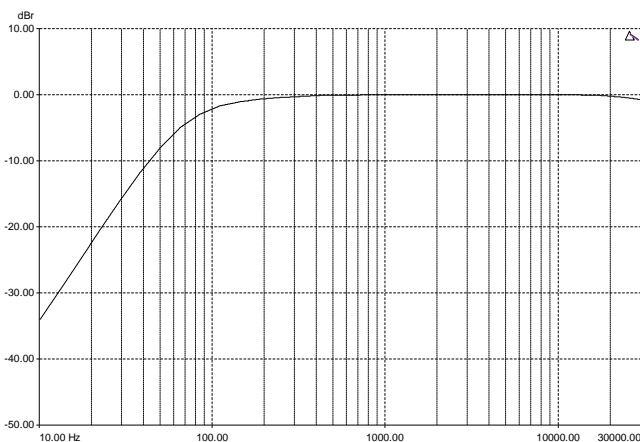

# MONO INPUT CHANNEL

## HF EQ

The HF (High Frequency) equaliser affects the frequency response of the higher audible frequencies. The corner frequency of 12kHz is around 3dB from the maximum cut or boost of the circuit. It has plenty of gain and actually gives slightly more than the +/- 15dB legend suggests.

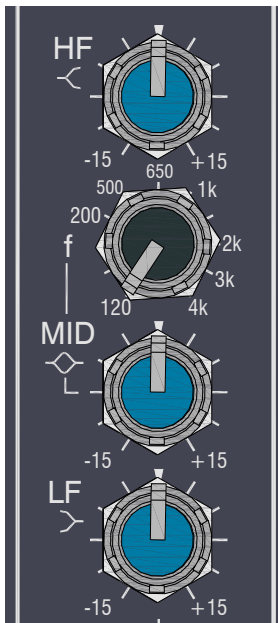
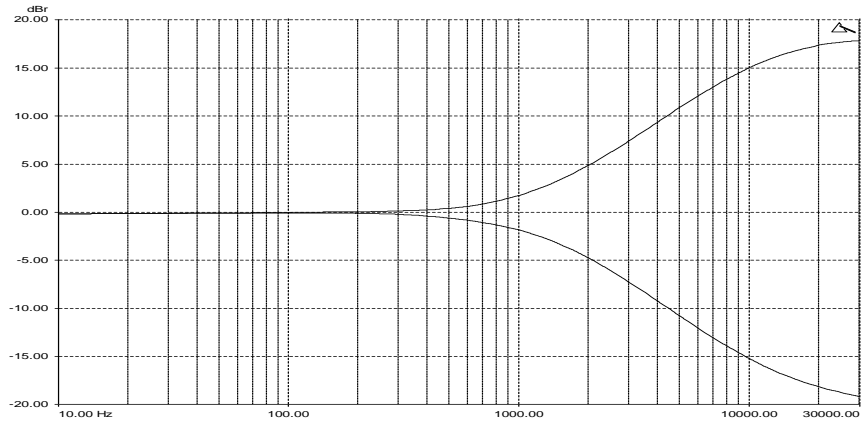

## MF EQ

The MF (Mid Frequency) equaliser affects the middle of the audible frequency range. The frequency graduations on the sweep control are the centre frequencies of the EQ. The range has been carefully chosen to cover “boomy” frequencies around 120Hz to 250Hz which may need cutting back, or a lift at 2 to 3kHz may be required for microphone intelligibility.

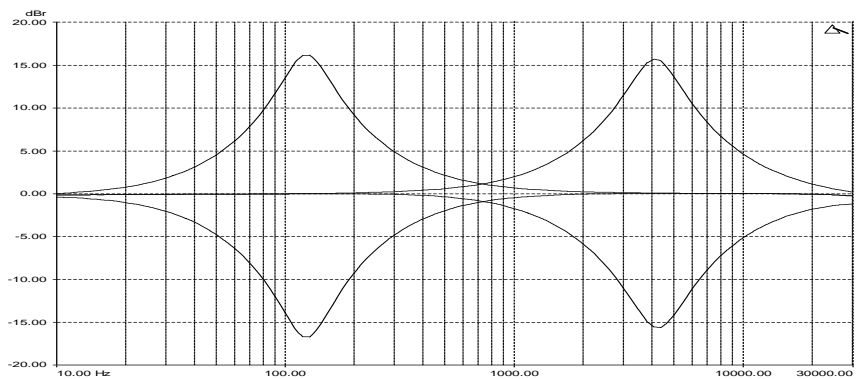

## LF EQ

The LF (Low Frequency) equaliser affects the response at the low end of the audio range. The graph shows the response of the LF EQ at maximum cut and boost. The corner frequency is 80Hz.

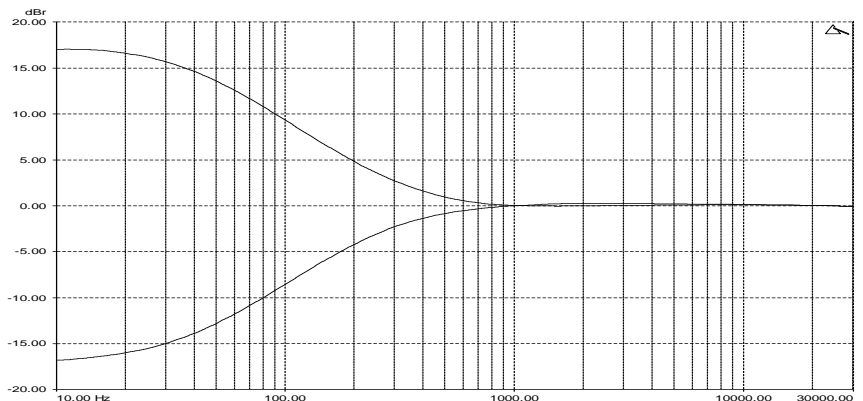



# MONO INPUT CHANNEL

## AUX

This control sends a signal to the auxiliary bus. The signal is sourced pre-fade (and pre ON switch) or post-fade (and post ON switch) depending on the PRE switch position. The send control varies the signal level to the bus from off (fully attenuated) to +6dB, with unity gain at the arrow.

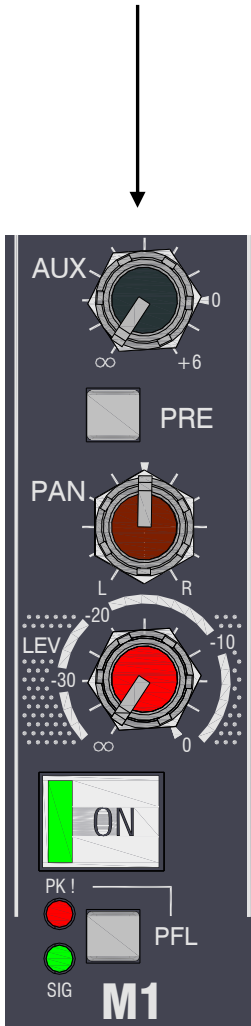

## PAN

The pan control adjusts how the signal from the mono input channel is shared between the left and right sides of the PGM bus. Set to the mid position, equal amounts of signal are fed to left and right, with pan set to L, none is sent to the Right bus.

## Level

This control adjusts the level of the channel signal to the left & right PGM bus, ALT bus and post fade Aux. With the pot fully clockwise, the channel has unity gain.

## ON Switch

This mechanically latching switch operates the channel mute circuitry, turning the signal to the PGM, ALT and Aux buses on or off. With the button depressed the signal is routed to the PGM bus and the pre/post AUX bus. With the button up the signal is routed to the ALT bus and the prefade AUX bus.

The switch is illuminated green when pressed.

There is also a remote mute option wired to a D type connector on the rear panel. When this is wired and operated the green ON LED is switched off, and the mute circuit is activated, regardless of whether the ON switch is pressed. Also the ON switch activates a logic output that can be used to control an 'ON AIR' light or similar.

## PFL Switch

The PFL (Pre-Fade Listen) switch sends the channel signal to the PFL bus and subsequently to the headphones/CRM speakers and the main L R meters. Used for checking the audio signal before raising the level or pressing the ON switch.

## SIGNAL & PEAK LEDS

The Signal LED illuminates when the pre-fader signal level is above -15dB.

The Peak LED illuminates and stays on for around 0.5 seconds when a peak level is detected (pre-fader signal) within 5dB of clipping.

# TELCO CHANNEL

## TELCO IN

The Telephone Communication channel input 1/4" (6.25mm) Jack socket . Wired as Tip=Hot (+), Ring=cold (-), Sleeve=Chassis.

## CLF OUT

Standard 1/4" (6.25mm) Jack socket for the Clean-Feed output from the Telephone Communication channel.

Wired Tip=Hot (+), Ring=cold (-), Sleeve=Chassis. Impedance balanced. Nominal level = 0dBu. (See next page for more information about the cleanfeed output).

## TELCO Input Gain

The Telephone Communication channel input gain control. Varies the gain applied to the TELCO input channel from -10dB to +26dB.

## TELCO Input Selector

With the switch in the up position, the channel input is from the TELCO IN jack for use with a telephone hybrid system.

When the switch is depressed, the channel signal is routed from the USB connection so that the TELCO channel can be used with a VOIP connection such as SKYPE.

## 100Hz High Pass filter

Similar to the mono input channel, a 12dB per octave 2-pole high pass filter used to filter out any low frequency rumble or pops on the TELCO channel input.

## TELCO Channel EQ

The TELCO Channel EQ is 2 band with corner frequencies of 12kHz for the HF and 80Hz for the LF.

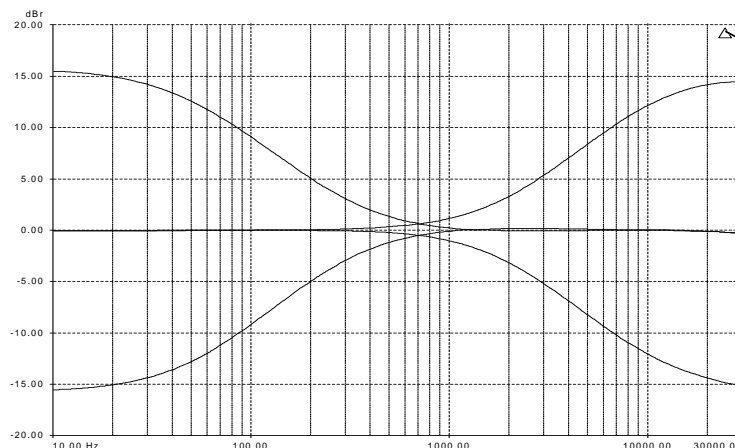

# TELCO CHANNEL

## TALK

The TALK switch enables the presenter or operator to communicate with the telephone caller with the presenters channel fader down so the presenters voice does not go to the program mix.

The source for the TALK signal is one of the mono channels, pre-selected by links set within the XB-10, the factory default is mono channel 1. The signal source is pre-fade and pre-mute on the selected mono channel.

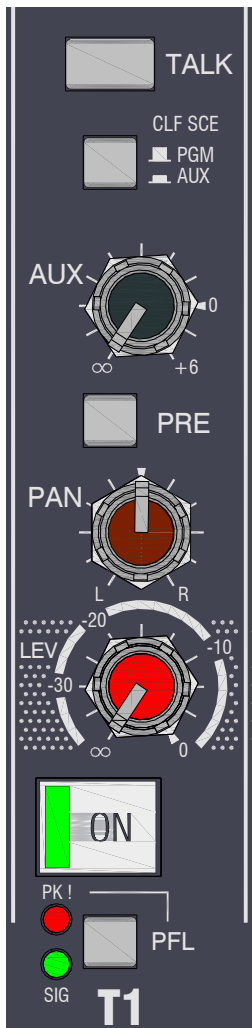

## CLF SCE

The Clean-Feed Source switch selects the signal source for the TELCO output. In the un-pressed position the signal will be the entire program (PGM) mix (pre main PGM fader) but without the signal from the input on the TELCO channel, so the caller does not hear any distracting echo of their voice.

If the switch is pressed, the TELCO output signal is sourced from the AUX bus, but minus the AUX signal sent from the TELCO channel.

This is a really useful feature that can enable the operator to send a mix of signals from different channels to the telephone caller using the AUX bus, the sources may be on or off air because the sources for the AUX bus can be pre or post fader.

In addition, the AUX bus can be used for off-air audition or recording of an interview with a telephone caller (or callers), using pre-fade signals to the AUX bus for later playback or editing for the broadcast.

## AUX

This control sends a signal to the auxiliary bus. The signal is sourced pre-fade (and pre ON switch) or post-fade (and post ON switch) depending on the PRE switch position. The send control varies the signal level to the bus from off (fully attenuated) to +6dB, with unity gain at the arrow.

## PAN

The pan control adjusts how the signal from the TELCO input channel is shared between the left and right sides of the PGM bus. Set to the mid position, equal amounts of signal are fed to left and right, with pan set to L, none is sent to the Right bus.

# TELCO CHANNEL

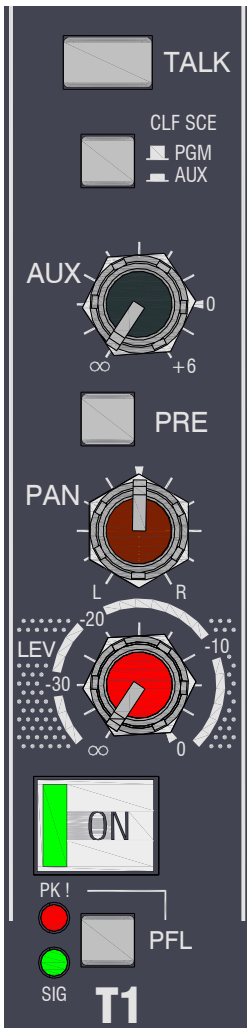

## Level

This control adjusts the level of the channel signal to the left & right PGM bus, ALT bus and post fade Aux.

With the pot fully clockwise, the channel has unity gain.

## ON Switch

This mechanically latching switch operates the channel mute circuitry, turning the signal to the PGM, ALT and Aux buses on or off.

With the button depressed the signal is routed to the PGM bus and the pre/post AUX bus. With the button up the signal is routed to the ALT bus and the prefade AUX bus.

The switch is illuminated green when pressed.

There is also a remote mute option wired to a D type connector on the rear panel.

When this is wired and operated the green ON LED is switched off, and the mute circuit is activated, regardless of whether the ON switch is pressed. Also the ON switch activates a logic output that can be used to control an 'ON AIR' light or similar.

## PFL Switch

The PFL (Pre-Fade Listen) switch sends the channel signal to the PFL bus and subsequently to the headphones/CRM speakers and the main L R meters. Used for checking the audio signal before raising the level or un-muting the channel.

## SIGNAL & PEAK LEDs

The Signal LED illuminates when the pre-fader signal level is above  $-15\text{dB}$ .

The Peak LED illuminates and stays on for around 0.5 seconds when a peak level is detected (pre-fader signal) within 5dB of clipping.

# STEREO INPUT CHANNELS



## Monitor input / USB input

The monitor input is on standard RCA phono sockets and is commoned with the ST1 inputs. This means that the monitor input will appear on the ST1 channel if nothing is plugged in on the 1/4" channel jacks.

The USB input channel is commoned with the ST3 channel and works in the same manner.

## Stereo Channel Inputs

Standard 1/4" jack sockets for input signals to ST1 - 3. Wired Tip=Hot(+), Ring=cold (-), Sleeve=Chassis. Impedance balanced. Nominal input level = 0dBu.

## Stereo input level control

For adjustment of the stereo input levels from fully attenuated to +15dB of gain.

## Stereo channel EQ

The stereo channel EQ is 2 band with corner frequencies of 12kHz for the HF and 80Hz for the LF.

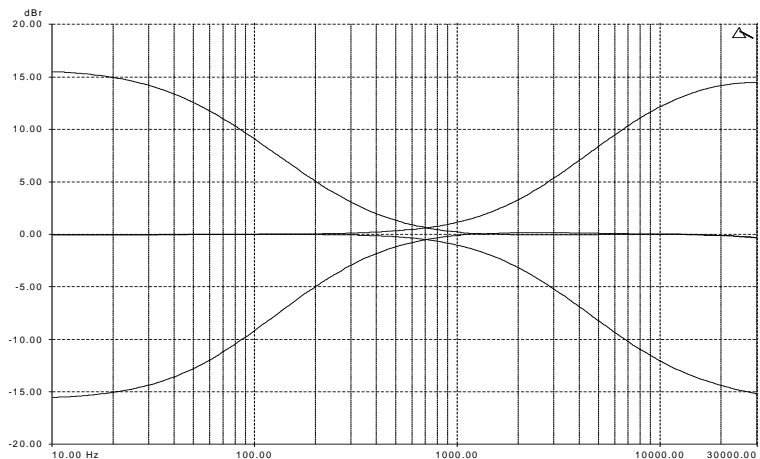

## AUX

This control sends a signal to the auxiliary bus and is a combined sum of the left and right stereo signals. The signal is sourced pre-fade (and pre ON switch) or post-fade (and post ON switch) depending on the PRE switch position. The send control varies the signal level to the bus from off (fully attenuated) to +6dB, with unity gain at the arrow.

# STEREO INPUT CHANNELS

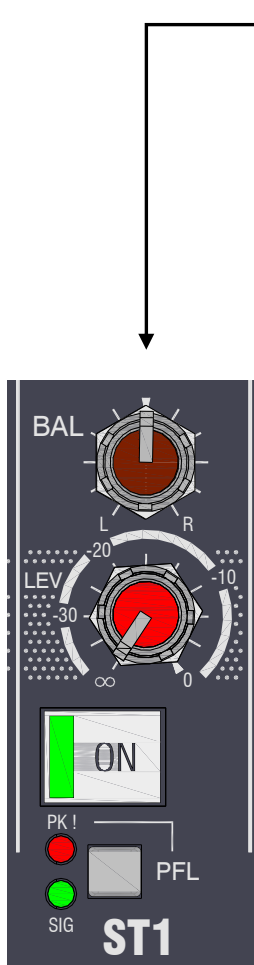

## BAL

The balance control adjusts the relative levels of the left & right signals in the stereo input channel as they are sent to the PGM bus. Set to the mid position, the signals are balanced equally. With the balance control set fully anticlockwise the right channel will be fully attenuated and the left channel will increase by approximately 3dB.

## Level

This control adjusts the level of the channel signal to the left & right PGM bus, ALT bus and post fade Aux. The left and right channels are mixed for the ALT and aux mono buses. With the pot fully clockwise, the channel has unity gain.

## ON (+START/CUE) switch

This mechanically latching switch operates the channel mute circuitry, turning the signal to the PGM, ALT and Aux buses on or off. With the button depressed the signal is routed to the PGM bus and the pre/post AUX bus. With the button up the signal is routed to the ALT bus and the prefade AUX bus. The switch is illuminated green when pressed. The ON switch also activates the START/CUE logic signals (for the corresponding selected input) wired to the remote interface connector on the rear panel. This allows the ON switch to start or cue a transport such as a CD player.

## PFL Switch

The PFL (Pre-Fade Listen) switch sends the channel signal to the PFL bus and subsequently to the headphones/CRM speakers and the main L R meters. Used for checking the audio signal before raising the level or un-muting the channel.

## SIGNAL & PEAK LEDs

The Signal LED illuminates when the pre-fader signal level is above  $-15\text{dB}$ . The Peak LED illuminates and stays on for around 0.5 seconds when a peak level is detected (pre-fader signal) within 5dB of clipping.

# OUTPUTS

## GROUND CANCEL SELECTORS

Both the MON OUT and RECORD OUT connectors are ground cancelled. The signal ground is lifted with a 75ohm impedance to eliminate issues with hum and earth loops. To disable this function and allow a direct earth connection, depress the rear switches with a matchstick or similar.

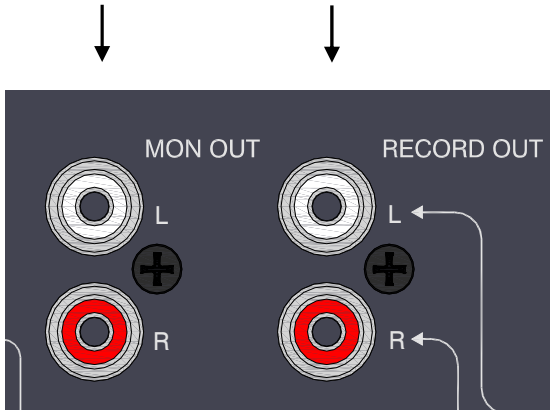

### RECORD OUT

This is the PGM mix but taken before the main output level pot. Standard RCA phono sockets. Ground cancelled output. Nominal level = 0dBu.

### MONITOR OUT

This is the mix generated by the operator phones selection matrix. Its level is controlled by the MONITOR LEVEL pot. The MIC MUTE MONITOR function will mute this output if any of the mic channel ON switches are illuminated. This output can also be muted by an external switch attached to the REMOTE connector on the back of the unit. The main function of this output is to feed speakers for the studio. Standard RCA phono sockets. Ground cancelled output. Nominal level = 0dBu.

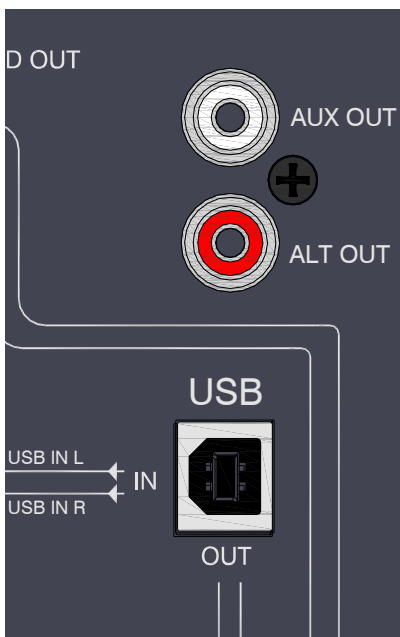

### AUX OUT

This is the output for the AUX mix and its level is controlled by the AUX MASTER control. Standard RCA phono sockets. Ground cancelled output. Nominal level = 0dBu.

### ALT OUT

This is the output for the ALT mix. Levels are controlled by the channel level pots only. When channel ON switches are in the up position, the channel is fed to the ALT mix. Standard RCA phono sockets. Ground cancelled output. Nominal level = 0dBu.

### USB audio send & return

The USB connection uses a USB 1.1 compliant stereo USB audio CODEC which is also fully compliant with USB 2. The connector is a standard USB "B Type" connector. When connected to a computer (Windows or Mac) you will be able to transfer stereo audio to and from the XB-10. Please see the next page for selecting USB send options. The USB audio input can be selected to feed the stereo channel 3 (ST3) by leaving the ST3 1/4" input jacks unplugged

# OUTPUT SELECTOR



## USB OUT SOURCE

The signal source for the USB send is selected using the switches below the USB connector.

If both switches are un-pressed, the pre level main program mix will be sent to the USB output, if the AUX-ALT button is pressed then the AUX and ALT mixes will be sent to the left and right channels respectively. If the CLF-TELCO button is pressed then the left channel will send the telco channel cleanfeed and the right channel will send the TELCO channel signal.

The CLF-TELCO feed is primarily for use with a VOIP program such as SKYPE. The left channel is used by SKYPE to send a cleanfeed mix to the caller. The left and right channels can be recorded using another piece of software to give a copy of the callers channel and the program cleanfeed mix.

## RECORD OUT SOURCE

The signal source for the RECORD output is selected using these switches.

If both switches are un-pressed, the pre level main program mix will be sent to the REC OUT phono connectors, if the AUX-MONO button is pressed then the AUX and MONO mixes will be sent to the left and right channels respectively. If the CLF-TELCO button is pressed then the left channel will send the telco channel cleanfeed and the right channel will send the TELCO channel signal.

## AUX MASTER

This controls the amount of signal sent to the AUX OUTPUT RCA phono socket. The send control varies the signal level from off (fully attenuated) to +6dB, with unity gain at the arrow.

## MONITOR LEVEL

This controls the amount of signal sent to the MON OUT RCA phono sockets. The send control varies the signal level from MIN (fully attenuated) to MAX (+10dBu).

## MUTE LED / MIC MUTE MONITOR SWITCH

Press the MIC MUTE MONITOR option switch to activate the monitor speaker muting.

This is used to turn off studio monitor speakers when the MIC channels are being used to eliminate any feedback paths.

When a MIC channel ON switch is illuminated, the mute LED will come on and the MON OUT feeds are muted.

The MON OUT feed can also be remotely operated using logic connected to the rear panel. The mute LED will also come on in this case.



# MASTER SECTION

## Output Limiter

The limiter controls are on the rear panel of the XB-10. Use a matchstick or similar to press both mode switches, this activates the limiter for the left and right channels respectively. The trimmer pot can be adjusted with a small bladed screwdriver and this allows the limiter threshold range to be changed from 0dBu to 21dBu.

The limiter LED will come on as soon as the limiter reaches its threshold.

## Main PGM Outputs

Standard XLR output connector for the main program mix left & right outputs. Wired Pin 1=Chassis, Pin 2=hot (+), Pin 3=Cold (-). Electronically balanced, nominal level = +4dBu (=0VU).

## Main PGM Inserts

Standard 1/4" (6.25mm) Jack socket for unbalanced insert send and return signals. Wired Tip=send, Ring=return, Sleeve=Chassis. Nominal level is -2dBu. The insert point is pre the main PGM fader.

## Headphone Output Sockets

Standard 1/4" (6.25mm) Jack sockets for the engineer/self operator and guest. Wired Tip=Left (+), Ring=Right (-), Sleeve=Ground.

## 48v Phantom Power switch

Press this in to switch 48v Phantom Power to the 3 Mic input xlr connectors, if any of the microphones attached require power. Dynamic microphones won't mind being connected to a phantom powered input, but care is needed to ensure that 48v is not switched on if an xlr is used to input a signal from an electronic circuit (ie. Another mixer).

**When switching 48v on or off, or plugging in connectors to channels with 48v present, it is important (and normal procedure) to mute the channels.**

## Main Program Level

The main program mix level control. Affects the stereo PGM XLR outputs and phones feeds, but not the prefade PGM outputs to USB and RECORD OUT. 0dB, or unity gain is at the top of the control.

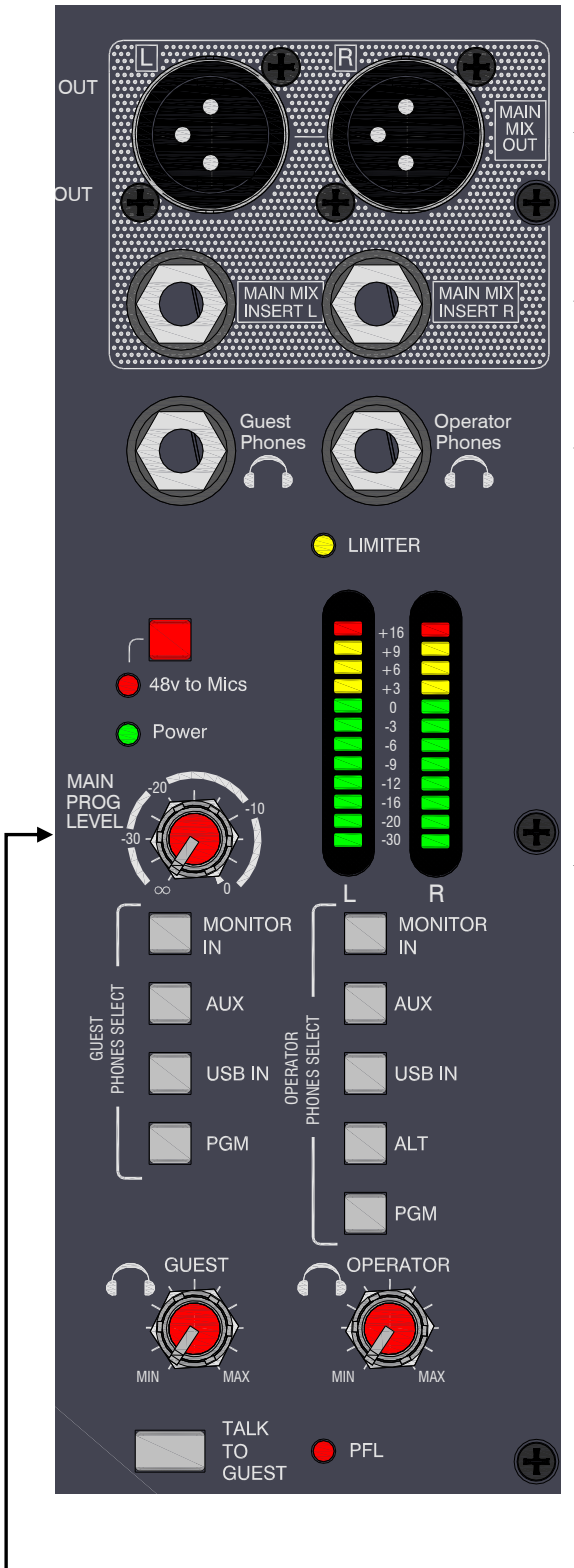

# MASTER SECTION

## Main Left & Right meters

12 segment LED meters, peak type response, the "0" position reflects nominal level at the outputs (+4dBu from the main PGM outputs). The meters display the signals from the Operator phones selector switches below, or the PFL (pre-fade listen) signal from any selected channels, which overrides.

## Operator phones Source Selector switches

These 5 switches select the signal source for the monitor speakers, operator phones and the meters. They work on a signal mix basis. By pressing a button, the corresponding signal is added to the mix. Pressing two buttons mixes both feeds together. The PFL signal will override the selection if activated.

## Guest phones Source Selector switches

Similar to the Operator phones selection switches, these select the source for the guest headphones output. A different source can be selected for the guests to that selected for the operator. The PFL signal is not fed to the guest phones outputs.

## Guest / Operator phones level

Adjusts the level of the signal to the guest / operator phones from off (fully attenuated) to unity gain.

**Warning !** To avoid damage to your hearing do not operate the headphones or sound system at excessively high volume. Continued exposure to high volume sound can cause frequency selective or wide range hearing loss.

## PFL on light

This LED will come on when any channel PFL switch is pressed. The PFL signal received is then routed to the operator phones and monitor. The signal overrides the current selection.

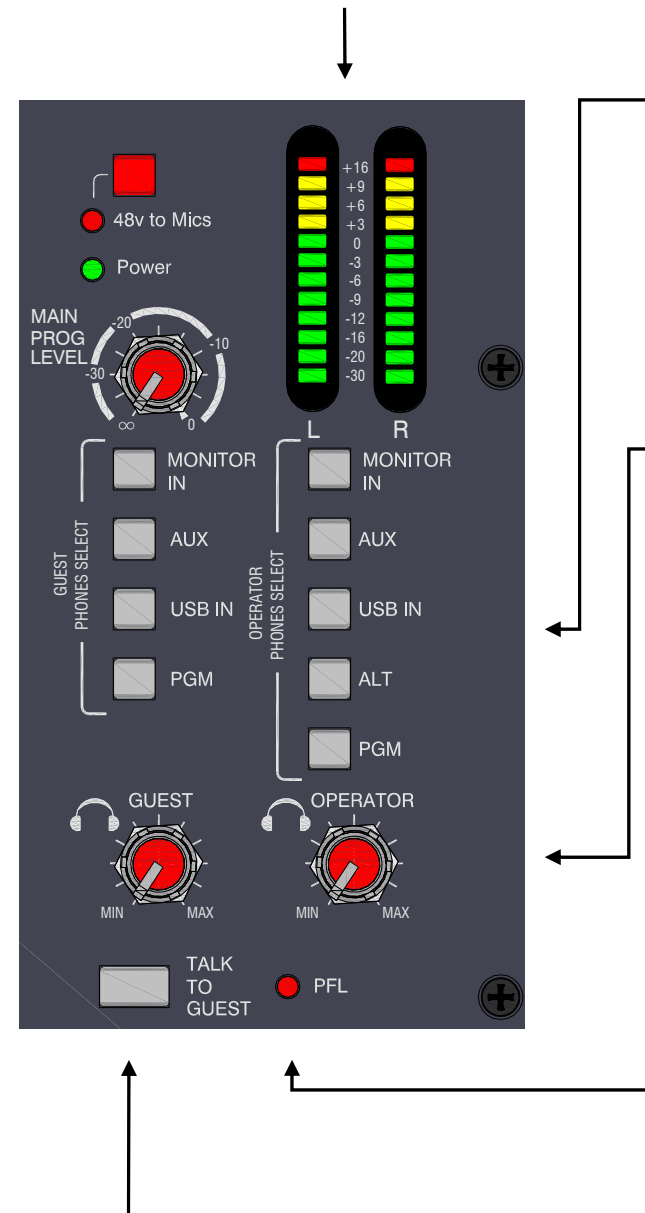

## Talk to guest button

The TALK switch enables the presenter or operator to communicate with the guest with the presenters channel fader down so the presenters voice does not go to the program mix.

The source for the TALK signal is one of the mono channels, preselected by links set within the XB-10, the factory default is mono channel 1. The signal source is pre-fade and pre-mute on the selected mono channel.

# REMOTE INTERFACE CONNECTOR

25 Way D socket connector REMOTE	
PIN	FUNCTION
1	M1 ON LOGIC (OPEN COLLECTOR OUTPUT)
2	M2 ON LOGIC (OPEN COLLECTOR OUTPUT)
3	M3 ON LOGIC (OPEN COLLECTOR OUTPUT)
4	TELCO ON LOGIC (OPEN COLLECTOR OUTPUT)
5	CONTROL ROOM MUTE (INPUT, ACTIVE LOW)
6	GROUND
7	ST1 START PULSE
8	ST1 STOP PULSE
9	ST2 START PULSE
10	ST2 STOP PULSE
11	ST3 START PULSE
12	ST3 STOP PULSE
13	GROUND
14	M1 EXTERNAL MUTE (INPUT, ACTIVE LOW)
15	M2 EXTERNAL MUTE (INPUT, ACTIVE LOW)
16	M3 EXTERNAL MUTE (INPUT, ACTIVE LOW)
17	TELCO EXTERNAL MUTE (INPUT, ACTIVE LOW)
18	GROUND
19	+15V POWER OUTPUT (MAX 50mA)
20	+10V POWER OUTPUT (MAX 100mA)
21	SIGNAL GROUND
22	-15V POWER OUTPUT (MAX 50mA)
23	COMMS MIC CHANNEL OUTPUT (NOMINAL LEVEL 0dBu)
24	LEFT METER (POST FADE PROGRAM FEED)
25	RIGHT METER (POST FADE PROGRAM FEED)

## ON Logic

The ON logic outputs are an open collector transistor that is switched on when the channel on switches are pressed. The open collector outputs can be connected together to switch something collectively, such as an ON AIR light for example. Max current per channel is 50mA.

## Mute inputs

The mute input channels can be switched on with a button pulling them to ground or an open collector transistor switch to ground. When activated the relevant channel is muted and the ON light extinguished.

## Start/Cue logic

The Start/Cue logic from the Stereo channel ON switches is designed to interface to a common standard employed by Denon and Pioneer equipment. The logic signals are usually wired to a 2 pole 3.5mm jack plug where a low pulse on the tip starts the deck and a low pulse on the sleeve stops or cues the deck. There needs to be some form of ground connection between the equipment for this to work—normally effected by the audio connector leads.

## External meter outputs and comms mic feed

These feeds produce PGM L & R signals for external metering equipment. These are line level analogue signals, the level at 0VU will be 0dBu. There is also a comms mic feed that can be used to communicate with an engineer or similar.

## External power

There is a 10v supply available for relays, ON air lights etc. Max current draw 100mA. A +15v/-15v supply is also available to supply low current audio equipment such as a powered PPM meter. Max current draw 50mA.

# REMOTE INTERFACE CONNECTOR

## REMOTE Connector Example

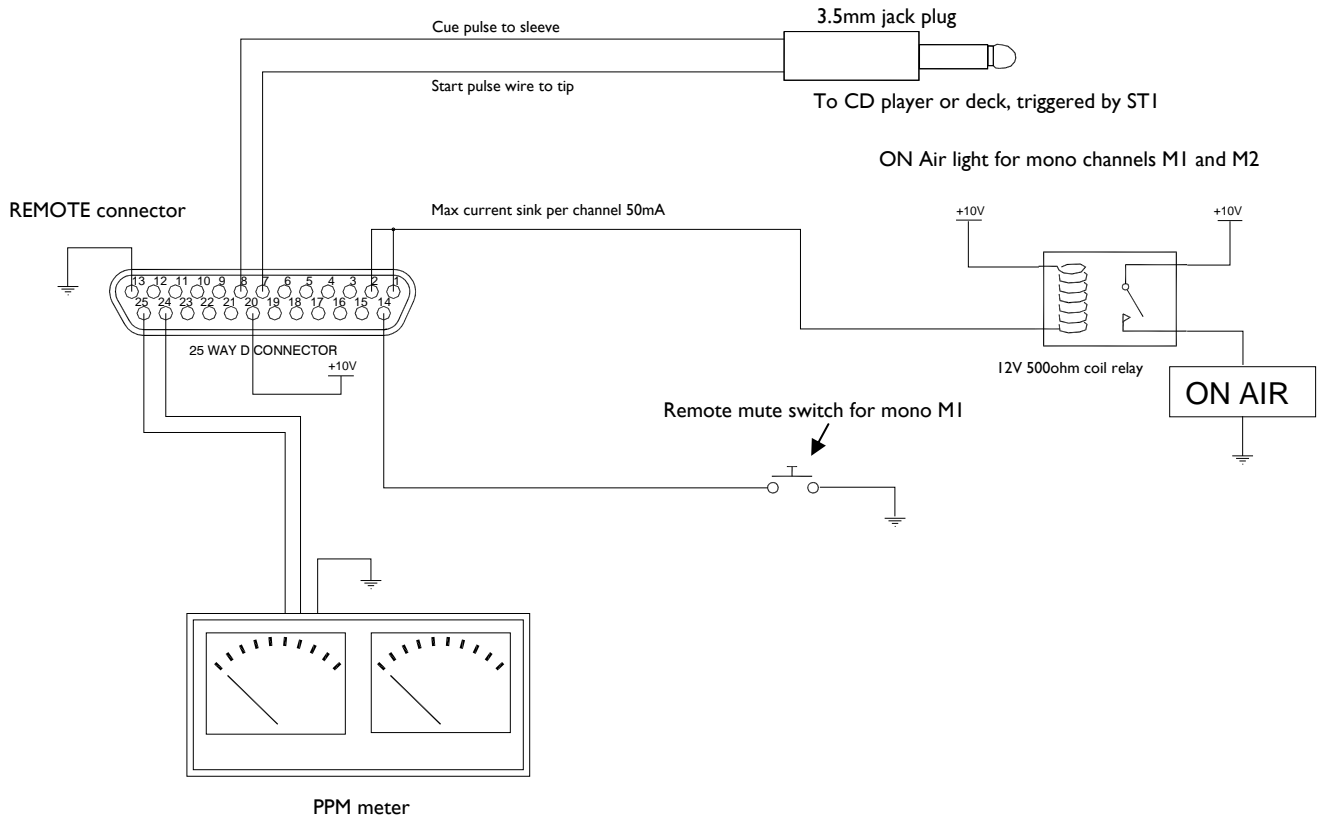

# CONNECTING TO A COMPUTER

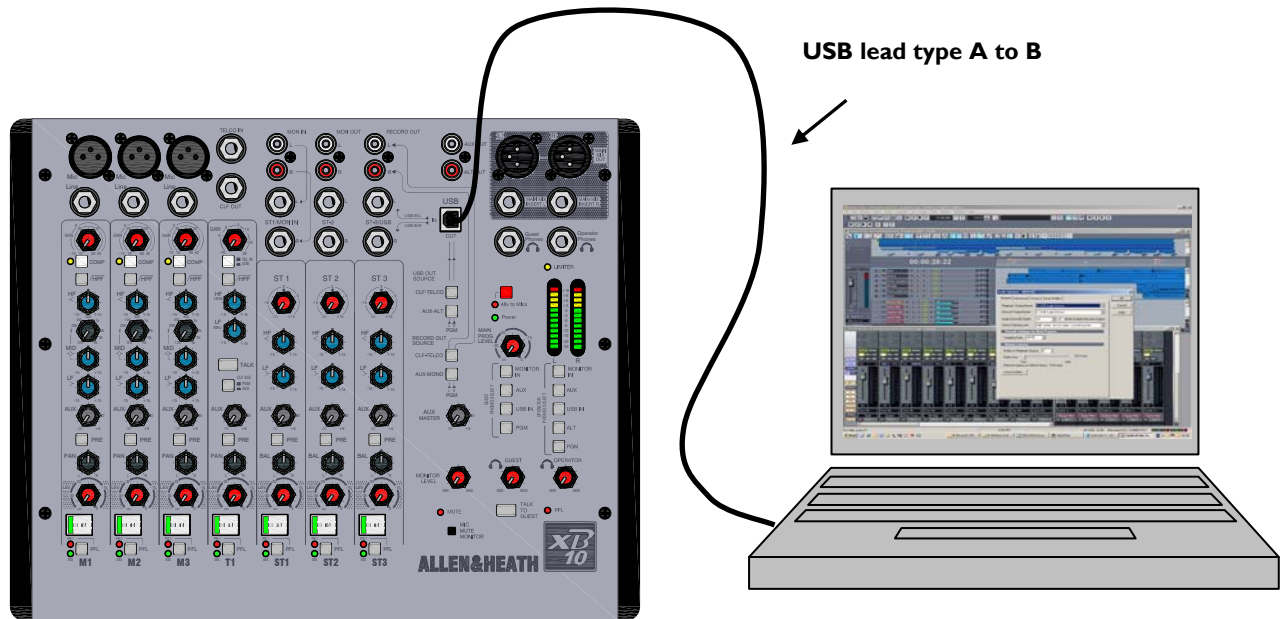

## USB Audio Interface

The XB-10 is equipped with a stereo bi-directional USB 1.1 compliant audio CODEC. It is fully compliant with USB2 ports and uses standard Windows and MAC Core Audio Drivers. In other words, plug it in and your computer will find it and be able to transfer audio to and from the USB device.

You will need some form of audio software running on your computer for playback/recording or a voice over internet phone, but on a basic level, you can use your computers media player to play straight to the XB-10 device.

Just a couple of points to look out for:

### Windows XP/Vista:

When you plug in your XB-10 USB interface to your computer, if the volume level is low or inaudible, check the device volume in control panel/Sounds and Audio Devices/Volume. Set the volume to High.

### Windows 7:

At present, Windows 7 treats the USB audio device as a microphone source instead of a line input, so set the device volume level much lower, we found setting to 3 is ideal.

# APPLICATION DIAGRAM: SELF OPERATION

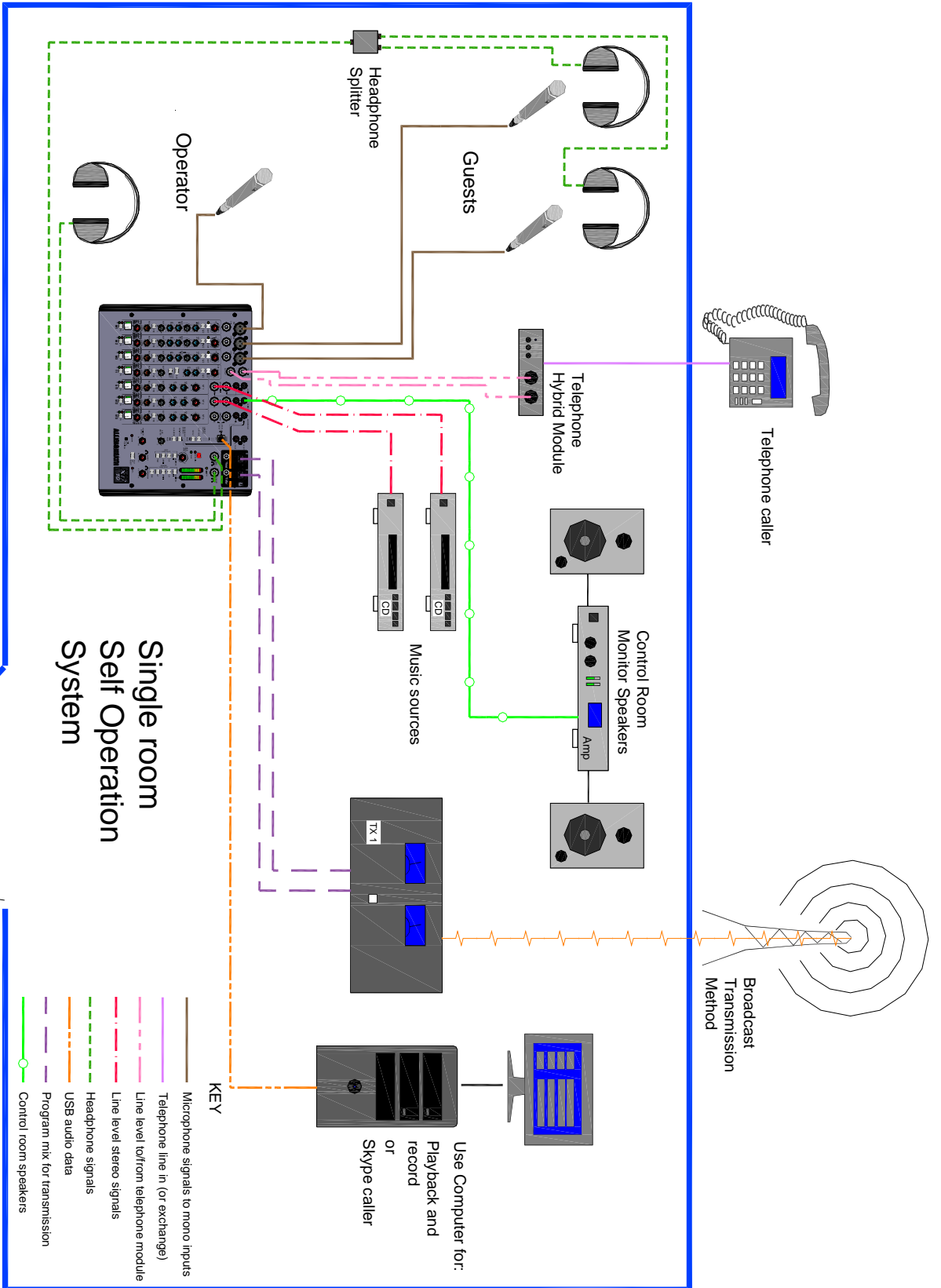

# APPLICATION DIAGRAM: STUDIO+CONTROL ROOM

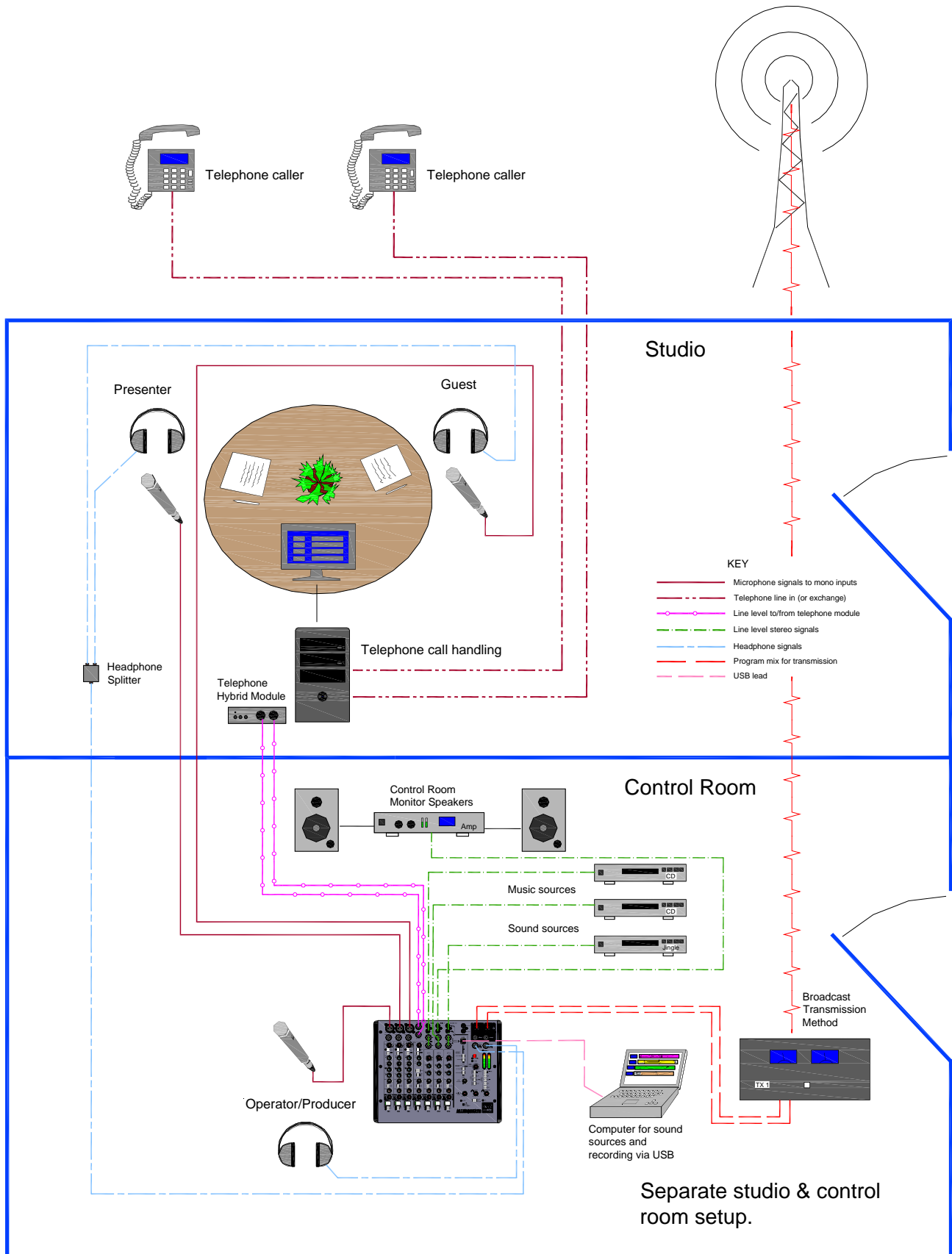

## APPLICATION TIPS: VOIP CALLER ON TELCO CHANNEL

This diagram shows the basic mixer setup for a conversation with a Skype/VOIP caller.

Ensure the buttons marked with a star are pressed to route the telco channel and cleanfeed to the computer VOIP program.

Before going to air the presenter can speak with the caller. Do this by monitoring the telco channel with the PFL button. Pressing the telco channel talk button will allow the caller to hear the presenter.

Pressing the presenter and telco channel ON buttons and raising the channel faders will allow an on-air conversation.

Using a recording program such as Audacity, you can also record the caller and cleanfeed signals.

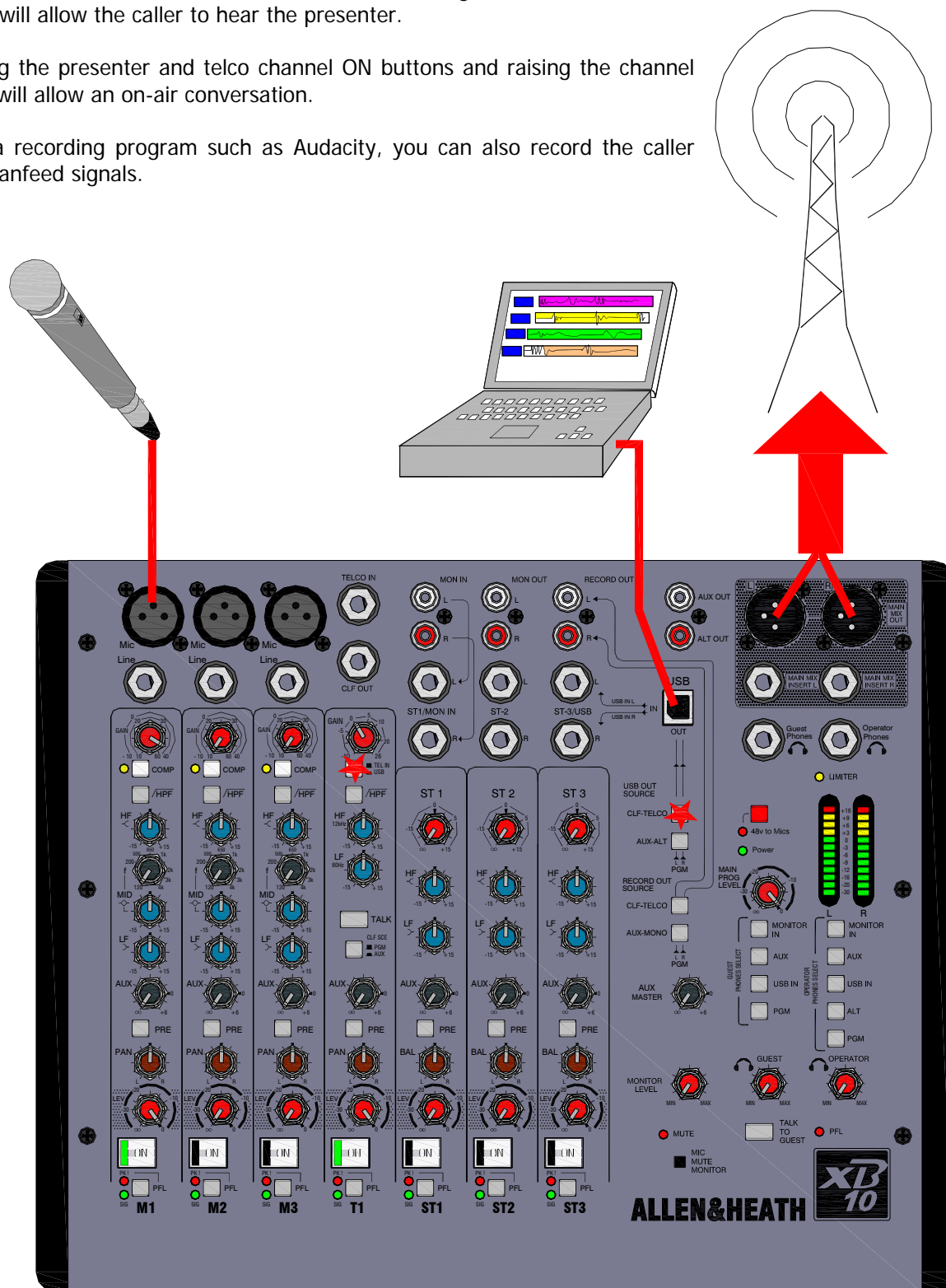



# WIRING NOTES

## Insert cable wiring

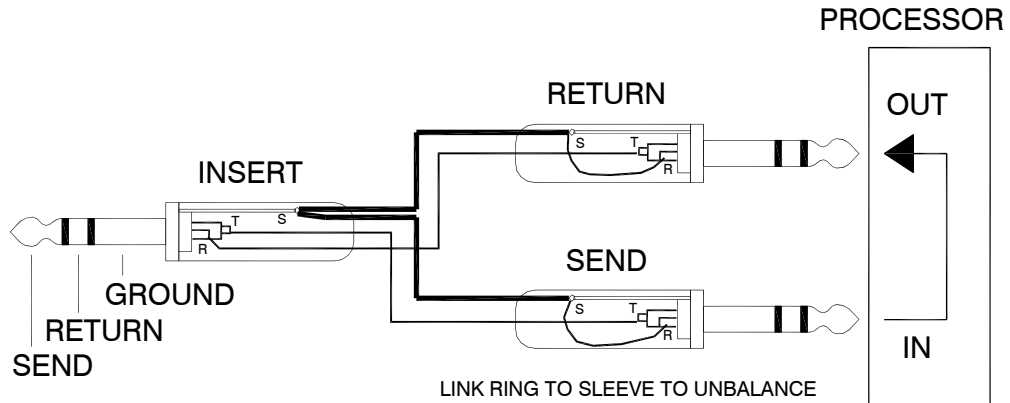

## General Wiring Information

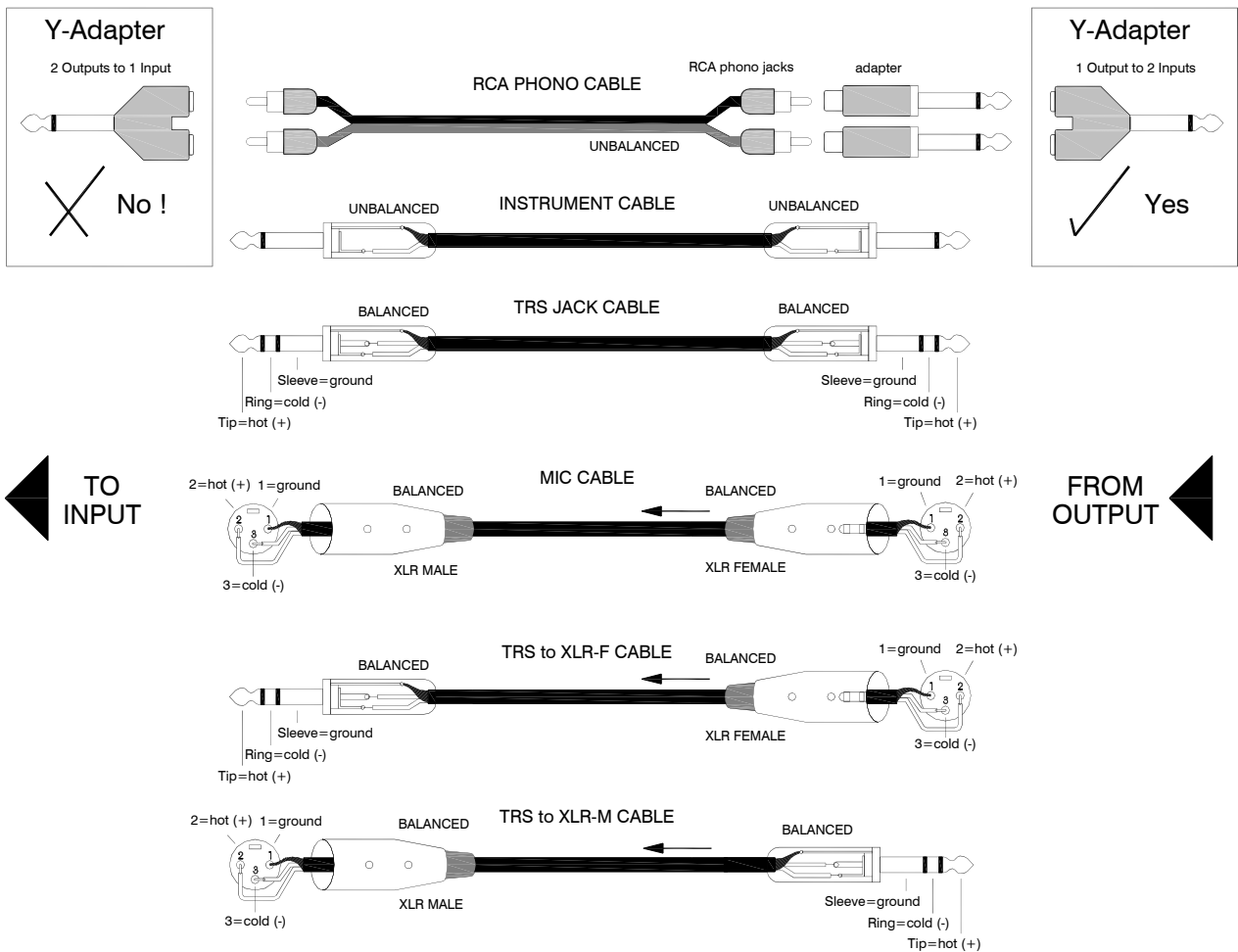

# PRODUCT SUPPORT

Investigate ALLEN & HEATH's other ranges at [www.allen-heath.com](http://www.allen-heath.com)

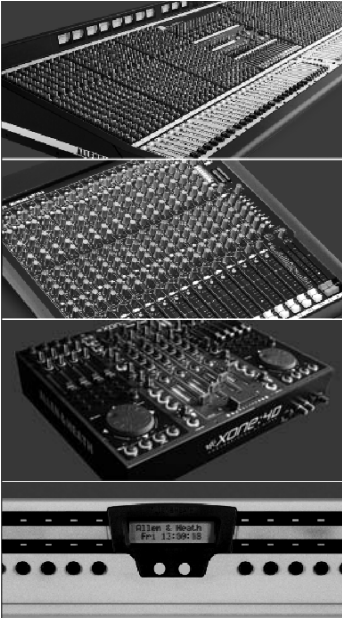

Large Live Sound mixers — iLive digital, ML and GL Series

Small Format Live Sound mixers — ZED, MixWizards , PA Series, XB

DJ products — Xone Series

Sound Management Series — iDR Series

## Registering your product

Thank you for buying the Allen & Heath XB-10 mixer. We hope that you are happy with it and that you or your end users enjoy many years of faithful service with it.

Please go to [www.allen-heath.com/register.asp](http://www.allen-heath.com/register.asp) and register your product's serial number and your details. By registering with us and becoming an official Registered User, you will ensure that any warranty claim you might make is actioned quickly and with the minimum delay.

Alternatively, you may either copy or cut off this section of the page, fill in the details, and return it by mail to:

Allen & Heath Ltd, Kernick Industrial Estate, Penryn, Cornwall TR10 9LU, UK



**ALLEN & HEATH PRODUCT REGISTRATION**

Thankyou for buying an Allen & Heath product. We hope that you're happy with it and that you enjoy many years of faithful service with it.

SERIAL NUMBER

Please return this section of the card by mail and retain the other part for your records. You can also register online at [www.allen-heath.com](http://www.allen-heath.com). Thanks for your help.

Your Name: \_\_\_\_\_

Company Name: \_\_\_\_\_

Address 1: \_\_\_\_\_

Address 2: \_\_\_\_\_

Town/City: \_\_\_\_\_ County/State: \_\_\_\_\_

Country: \_\_\_\_\_ Postcode/Zip: \_\_\_\_\_

Telephone: \_\_\_\_\_

Email: \_\_\_\_\_

Why did you choose this console? \_\_\_\_\_

Which other products did you consider before choosing A&H? \_\_\_\_\_

Is there any thing you would like to improve on this mixer? \_\_\_\_\_

What audio magazines do you read? \_\_\_\_\_

If you were going to design a mixer for your work, what are the 6 most important features it should have (in order of importance)

1 \_\_\_\_\_ 2 \_\_\_\_\_

3 \_\_\_\_\_ 4 \_\_\_\_\_

5 \_\_\_\_\_ 6 \_\_\_\_\_

We may use the information you provide to inform you of future product developments. We will not give or sell this data to third parties. Please indicate with an 'x' if you do not wish to receive any further communications from us.



