

# ALLEN & HEATH

## ICE-16 USER GUIDE



Publication AP8900



# CONTENTS

Warranty .....	4
Conformity Statement.....	5
Safety Instructions .....	6
Packed Items Checklist.....	9
Introduction to ICE-16 .....	10
Applications Drawings .....	11
Front Panel Controls & Features.....	14
Rear Panel Features .....	15
USB Direct Recording Quickstart.....	16
Recording to USB Memory—Important Notes.....	17
USB Memory Initialisation and Formatting.....	18
USB Recording Front Panel Controls.....	19
Recording to USB Memory—Further Notes .....	20
Playlist Mode.....	22
FireWire Driver—Installation (PC).....	23
FireWire Driver—Control Panel (PC) .....	24
USB Driver—Installation (PC).....	27
USB Driver—Control Panel (PC).....	29
Connecting to a Mac computer .....	31
USB Memory File Structure .....	31
USB Memory Recording—Synchronising units.....	33
Connecting Mixing Consoles to ICE-16.....	35
Specifications.....	36
Dimensions & Weights .....	38
Block Diagram.....	39

# WARRANTY

## Limited One Year Warranty

This product is warranted to be free from defects in materials or workmanship for period of one year from the date of purchase by the original owner.

To ensure a high level of performance and reliability for which this equipment has been designed and manufactured, read this User Guide before operating. In the event of a failure, notify and return the defective unit to ALLEN & HEATH Limited or its authorised agent as soon as possible for repair under warranty subject to the following conditions

### **Conditions Of Warranty**

The equipment has been installed and operated in accordance with the instructions in this User Guide.

The equipment has not been subject to misuse either intended or accidental, neglect, or alteration other than as described in the User Guide or Service Manual, or approved by ALLEN & HEATH.

Any necessary adjustment, alteration or repair has been carried out by ALLEN & HEATH or its authorised agent.

The defective unit is to be returned carriage prepaid to ALLEN & HEATH or its authorised agent with proof of purchase.

Units returned should be packed to avoid transit damage.

In certain territories the terms may vary.

Check with your ALLEN & HEATH agent for any additional warranty which may apply.

<http://www.allen-heath.com>

## EMC & SAFETY

This product complies with the European Electro magnetic Compatibility directives 2004/108/EC and the European Low Voltage Directives 2006/95/EC.

This product has been tested to EN55103 Parts 1 & 2 2009 for use in Environments E1, E2, E3, and E4 to demonstrate compliance with the protection requirements in the European EMC directive 2004/108/EC. During some tests the specified performance figures of the product were affected. This is considered permissible and the product has been passed as acceptable for its intended use. Allen & Heath has a strict policy of ensuring all products are tested to the latest safety and EMC standards. Customers requiring more information about EMC and safety issues can contact Allen & Heath.

NOTE: Any changes or modifications to the product not approved by Allen & Heath could void the compliance of the product and therefore the users authority to operate it.

ICE-16 User Guide AP8900 Issue 1

Copyright © 2012 Allen & Heath Limited. All rights reserved

Allen & Heath Limited

Kernick Industrial Estate, Penryn, Cornwall, TR10 9LU, UK

<http://www.allen-heath.com>

# SAFETY INSTRUCTIONS

**WARNING - Read the following before proceeding :**



**ATTENTION: RISQUE DE CHOC ELECTRIQUE – NE PAS OUVRIR**



**WARNING: This equipment must be earthed.**

**Read instructions:**

Retain these safety and operating instructions for future reference. Adhere to all warnings printed here and on the product. Follow the operating instructions printed in this User Guide.

**Do not remove cover:**

Operate the product with its covers correctly fitted.

**Power sources:**

Connect the product to a mains power unit only of the type described in this User Guide and marked on the rear panel. Use the power cord with sealed mains plug appropriate for your local mains supply as provided with the product. If the provided plug does not fit into your outlet consult your service agent for assistance.

**Power cord routing:**

Route the power cord so that it is not likely to be walked on, stretched or pinched by items placed upon or against it.

**Grounding:**

Do not defeat the grounding and polarisation means of the power cord plug. Do not remove or tamper with the ground connection in the power cord.

# SAFETY INSTRUCTIONS

**Water and moisture:** To reduce the risk of fire or electric shock do not expose the product to rain or moisture or use it in damp or wet conditions. Do not place containers of liquids on it which might spill into any openings.

**Ventilation:** Do not obstruct the ventilation slots or position the product where the air flow required for ventilation is impeded. If the product is to be operated in a rack unit or flightcase ensure that it is constructed to allow adequate ventilation.

**Heat and vibration:** Do not locate the product in a place subject to excessive heat or direct sunlight as this could be a fire hazard. Locate the product away from any equipment which produces heat or causes excessive vibration.

**Servicing:** Switch off the equipment and unplug the power cord immediately if it is exposed to moisture, spilled liquid, objects fall into the openings, the power cord or plug become damaged, during lightening storms, or if smoke, odour or noise is noticed. Refer servicing to qualified technical personnel only.

**Installation:** Install the product in accordance with the instructions printed in this User Guide. Do not connect the output of power amplifiers directly to the product. Use audio connectors and plugs only for their intended purpose.

## Important Mains plug wiring instructions

The product is supplied with a moulded mains plug fitted to the AC mains power lead. Follow the instructions below if the mains plug has to be replaced. The wires in the mains lead are coloured in accordance with the following code:

TERMINAL		WIRE COLOUR	
		European	USA/Canada
<b>L</b>	LIVE	BROWN	BLACK
<b>N</b>	NEUTRAL	BLUE	WHITE
<b>E</b>	EARTH GND	GREEN & YELLOW	GREEN

The wire which is coloured Green and Yellow must be connected to the terminal in the plug which is marked with the letter E or with the Earth symbol. This appliance must be earthed. The wire which is coloured Blue must be connected to the terminal in the plug which is marked with the letter N.

The wire which is coloured Brown must be connected to the terminal in the plug which is marked with the letter L.

Ensure that these colour codes are followed carefully in the event of the plug being changed.

# SAFETY INSTRUCTIONS

## General Precautions:

**Damage :** To prevent damage to the controls and cosmetics avoid placing heavy objects on the control surface, scratching the surface with sharp objects, or rough handling and vibration.

**Environment :** Protect from excessive dirt, dust, heat and vibration when operating and storing. Avoid tobacco ash, smoke, drinks spillage, and exposure to rain and moisture. If the product becomes wet, switch off and remove mains power immediately. Allow to dry out thoroughly before using again.

**Cleaning :** Avoid the use of chemicals, abrasives or solvents. The front panel is best cleaned with a soft brush and dry lint-free cloth. The switches and potentiometers are lubricated for life. The use of electrical lubricants on these parts is not recommended.

**Transporting :** Protect the controls from damage during transit. Use adequate packing if you need to ship the unit.

**Hearing :** To avoid damage to your hearing do not operate any sound system at excessively high volume. This applies particularly to close-to-ear monitoring such as headphones and in-ear systems. Continued exposure to high volume sound can cause frequency selective or wide range hearing loss.





# PACKED ITEMS

Check that you have received the following:

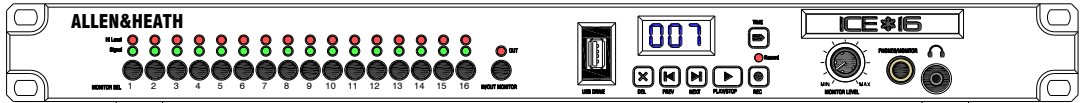

ICE-16

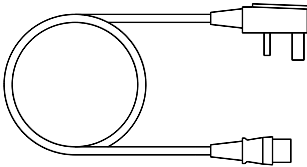

Mains Lead

Check that the correct mains plug is fitted.



This User Guide!

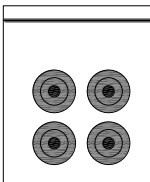

Plastic feet for non rack-mount use

# INTRODUCTION TO THE ICE-16

## **Background Overview:**

The Allen & Heath ICE-16 was designed to make life easier when it comes to recording multiple audio sources. Experience of struggling with boot-up and set up times when recording to a laptop at shows, and choosing the right converter unit made us think that there is a real need for a straightforward multi-channel analogue input capture unit that is both easy to use and high quality. So the ICE-16 was born.

## **Multi-application:**

The primary aim for the ICE-16 was to capture multiple channels of audio from an analogue mixer or other source of line level audio signals but it has so many more application possibilities. In addition to recording straight to a USB memory device, the ICE-16 can stream multi-channel audio in high resolution 24bit, up to 96kHz sample rate, to and from a computer so you can use the ICE-16 in a studio environment as well as live sound or event recording. In fact, if you were wondering where the name ICE came from, here is the explanation:

## **Interface - Capture - Expand**

**Interface:** The ICE-16 can function as a multi-channel analogue to digital and digital to analogue converter, connecting 24 bit audio at up to 96kHz sample rate to a computer via either IEEE1394 FireWire or USB-2. This is ideal for studio environments where analogue signals are converted and sent to a computer for recording to a Digital Audio Workstation (DAW).

**Capture:** Record 16 channels of audio in either 16 or 24 bit resolution (depending on the USB memory speed) at up to 48kHz sample rate, (96kHz with 8 channels) directly to a USB memory device—either a USB hard drive or memory stick.

**Expand:** You can link ICE-16 units together in different ways. You can daisy chain two units together using the FireWire ports in order to expand the number of channels connected to a computer. Or you can link two or more units together using the Sync ports in order to synchronise more than one ICE-16 when recording multiple channels,

**The Sync option is currently NOT implemented on the initial firmware release, but will be enabled by updating the firmware from a local computer.**

**Expected release date is Jan/Feb 2013.**

# APPLICATION: RECORDING TO USB MEMORY

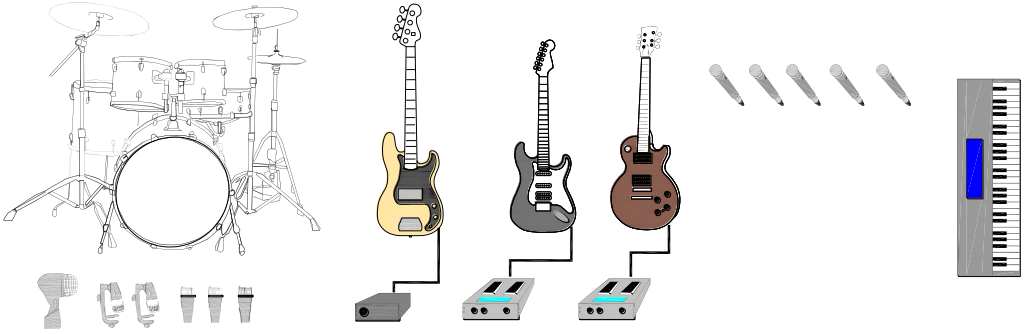

Mics & Instruments  
Into console.

Direct outs or to Line Inputs on ICE-I6

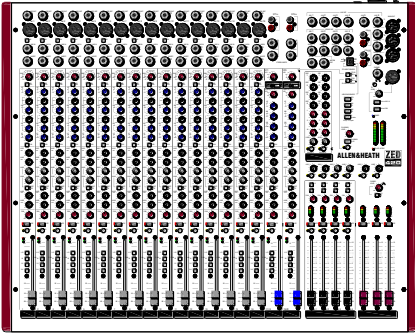

Mixing console

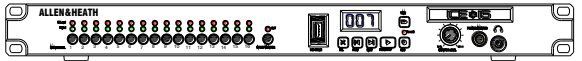
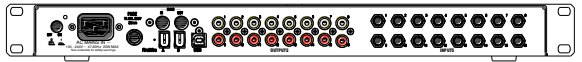

USB Memory stick or  
Drive

ICE-I6

Go to page I6 for Quickstart

## APPLICATION: VIRTUAL SOUNDCHECK

### Using ICE-16 for a Soundcheck

With pre-recorded instruments, vocals and drum sounds in your multi-channel Song folders, you can use ICE-16 to play individual channels to the line inputs of a mixing console so that you can set eq, monitor sends and create a mix even before the band arrives, leaving you to set the levels for the microphones and plug them into the designated channels on the console.

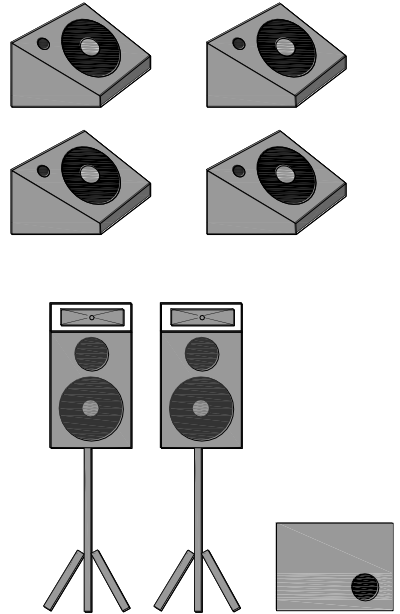

ICE-16 outputs to console line inputs

PA & Monitors

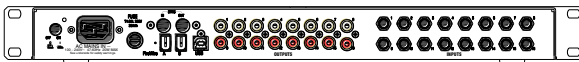

USB Memory stick or Drive

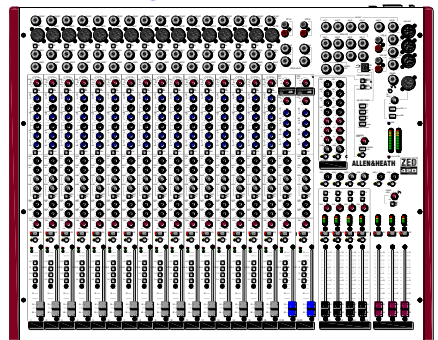

ICE-16

Mixing console

# APPLICATION: RECORDING STUDIO

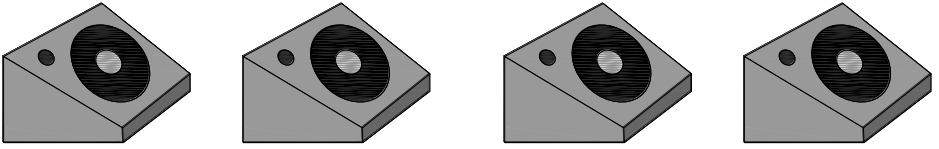

Artists' monitor amplifiers & speakers

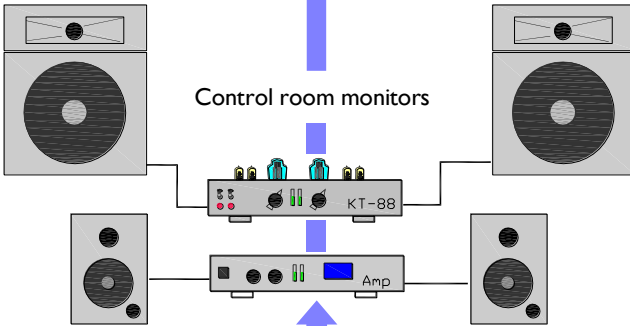

Control room monitors

DAW



ICE-16 outs to CRM etc.



ICE-16



To 2nd ICE

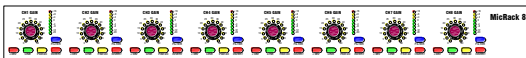

Pre-Amp unit

Mics & Instruments to pre-amp



ICE-16 can form an integral part of your recording studio setup. There are plenty of outputs for your studio monitors that you can control in the DAW.

# ICE-16 FRONT PANEL FEATURES

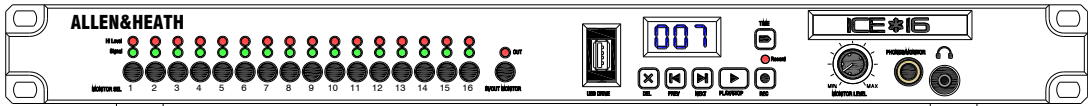

## Channel Monitoring and Metering

A switch per channel sends either the input or the output (depending on the IN/OUT switch) for that channel to the headphones monitor circuit. Multiple channels can be selected at once to create a mix of channels.

The green signal LED illuminates when a signal level is present above –22dBu (-42dBFS).

The red Peak warning LED illuminates when the signal level exceeds +14dBu (6dB before clipping).

The LEDs show signal either at the inputs or outputs depending on the IN/OUT switch.

## IN/OUT Switch

Allows you to choose the source for the headphones and the meter LEDs—either from the inputs or the outputs.

## USB Memory port.

Standard A type USB connector . Plug in your USB memory device here.

## Recorder Controls and Display

The user interface for recording direct to USB memory.

## Monitor Headphones

For checking individual or multiple inputs or outputs. Each signal is mono and therefore feeds both left and right ears. Both 1/4" and 3.5mm sockets are provided.

## Illuminated Display

Purely to make the ICE look nice! And to indicate that the power is switched on.

## ICE-16 REAR PANEL FEATURES

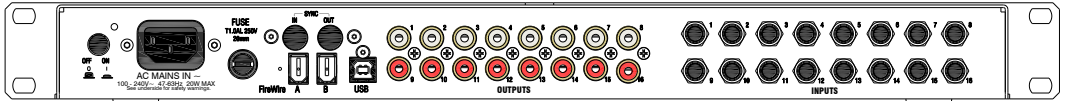

### Mains Power Supply, Switch and Fuse

Standard IEC mains power inlet. The ICE-16 accepts mains voltages from 90V to 265V at either 50Hz or 60Hz.

The On/Off switch powers the unit on or off.

The mains fuse is housed in the 20mm fuse holder

### Sync IN/OUT Connectors

**This feature will be available via a firmware release early 2013.**

9 pin mini DIN connectors. Use a 9 way mini DIN cable to connect the OUT of one ICE-16 unit to the IN of another. This allows two or more ICE-16s to be synchronised together when recording multiple tracks to more than one USB memory device.

**This feature will be available via a firmware release early 2013.**

### IEEE1394 FireWire Ports

Standard 6 pin IEEE1394 device ports. You can connect either of these to a host computer with FireWire in order to stream 16 channels of digital audio to and from the ICE-16. Two ICE-16s can be daisy-chained together to double the number of channels on the FireWire bus to 32..

### USB 2.0 Device Port

Type B USB device port. An alternative connection to FireWire for streaming 16 channels of digital audio to and from a computer.

### Outputs

RCA Phono connectors for analogue outputs 1 to 16. Nominal level 0dBu (775mV rms) Unbalanced.

### Inputs

Standard 1/4" TRS jack sockets for analogue inputs 1 to 16. Nominal level 0dBu (775mV rms). Unbalanced.

# RECORDING DIRECT TO USB MEMORY

## QUICKSTART



Power ON

1.

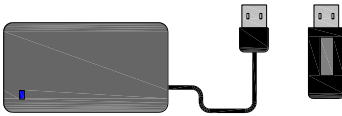

Plug in your USB hard drive or USB memory stick (see [www.allen-heath.com](http://www.allen-heath.com) for verified memory devices).

2.

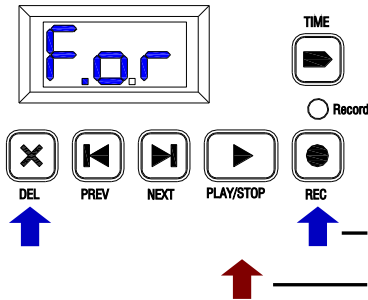

Format the memory device by pressing DEL+REC for 1 second. The display will show "For" and the dots will flash. The memory will be tested (display "tst") and the ICE-16 will automatically be set to either 24bit ("Hi") or 16bit ("Lo") mode depending on the memory quality.

Press & hold DEL & REC for 1 second

Confirm with PLAY/STOP

3.

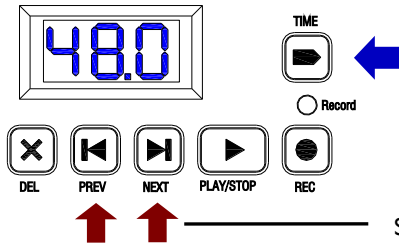

Check the sample rate the recorder is set to by pressing & holding TIME. The set sample rate will be displayed. For 16 channel recording this must be either 44.1 or 48kHz. Select the sample rate by continuing to hold TIME and pressing either PREV or NEXT. If you choose 88.2 or 96kHz then only channels 1-8 will be recorded.

Select sample rate (while holding TIME)

4.

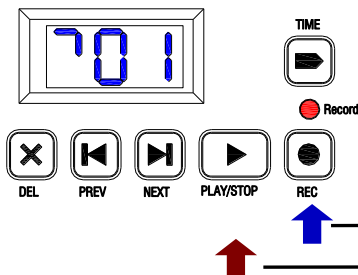

Press REC to start the first recording. The display will rotate segments and show the Song (or recording) number and the Record LED will be lit red. Press START/STOP to stop the recording or REC to stop and start the next one. Remaining time in minutes is displayed every 10 seconds (maximum 99 is displayed).

Press REC to start recording.

Press START/STOP to stop recording.



## RECORDING DIRECT TO USB MEMORY

**Please read these important notes regarding ICE-16 and USB memory devices.**

### **Functional Overview:**

There are no drivers required for this functionality—ICE-16 is ready to record to USB memory straight out of the box.

One of the first things to say is that USB memory devices have variable performance, depending on type and manufacture. The good news is that modern USB memory devices are now much faster and able to cope with the demands of writing high quantities of data reliably. It is important to understand however, that some USB memory, especially some sticks, will not meet the performance requirement for reliable operation, this is mainly due to the write speed.

**Please refer to a list of tested USB memory devices on the [www.allen-heath.com](http://www.allen-heath.com) website, on the product pages for ICE-16.**

### **Capability Description:**

ICE-16 can record standard wave (.wav) files to either a USB 2.0 hard drive or memory stick. The resolution will depend on the write speed of the memory. In general, USB hard drives will achieve the highest resolution of 24 bit at up to 48kHz sample rate, while most USB sticks will be set to record 16 bit at up to 48kHz sample rate. The bit depth will be set automatically, the sample rate can be set manually. Higher sample rates can be used (up to 96kHz) for recording direct to USB memory, the number of channels will be reduced from 16 to 8.

### **Connecting USB Memory**

Plug in your USB memory device into the USB DRIVE port on your ICE-16. Doing this will disconnect any computer connection plugged into any of the FireWire or USB ports on the rear-panel. You cannot record direct to USB memory and stream audio to a computer at the same time.

### **Formatting USB Memory**

ICE-16 will check the USB memory device each time it is connected. Previously formatted devices will not be tested, and any recorded songs will be displayed numerically. If the memory device is new and unformatted, ICE-16 will test it and display either the resolution mode Hi or Lo depending on the test result, or display Slo if the memory device does not have sufficient speed to cope with the data rate with the memory format. This may well be because the cluster size is set to 4, 8 or 16kbytes. It needs to be 32kbytes. Formatting the USB memory on the ICE-16 will correct this. So if the initial test results in Slo being displayed try formatting the memory to reset the cluster size and re-test the memory speed.

# RECORDING DIRECT TO USB MEMORY

## USB Memory Initialisation & Test

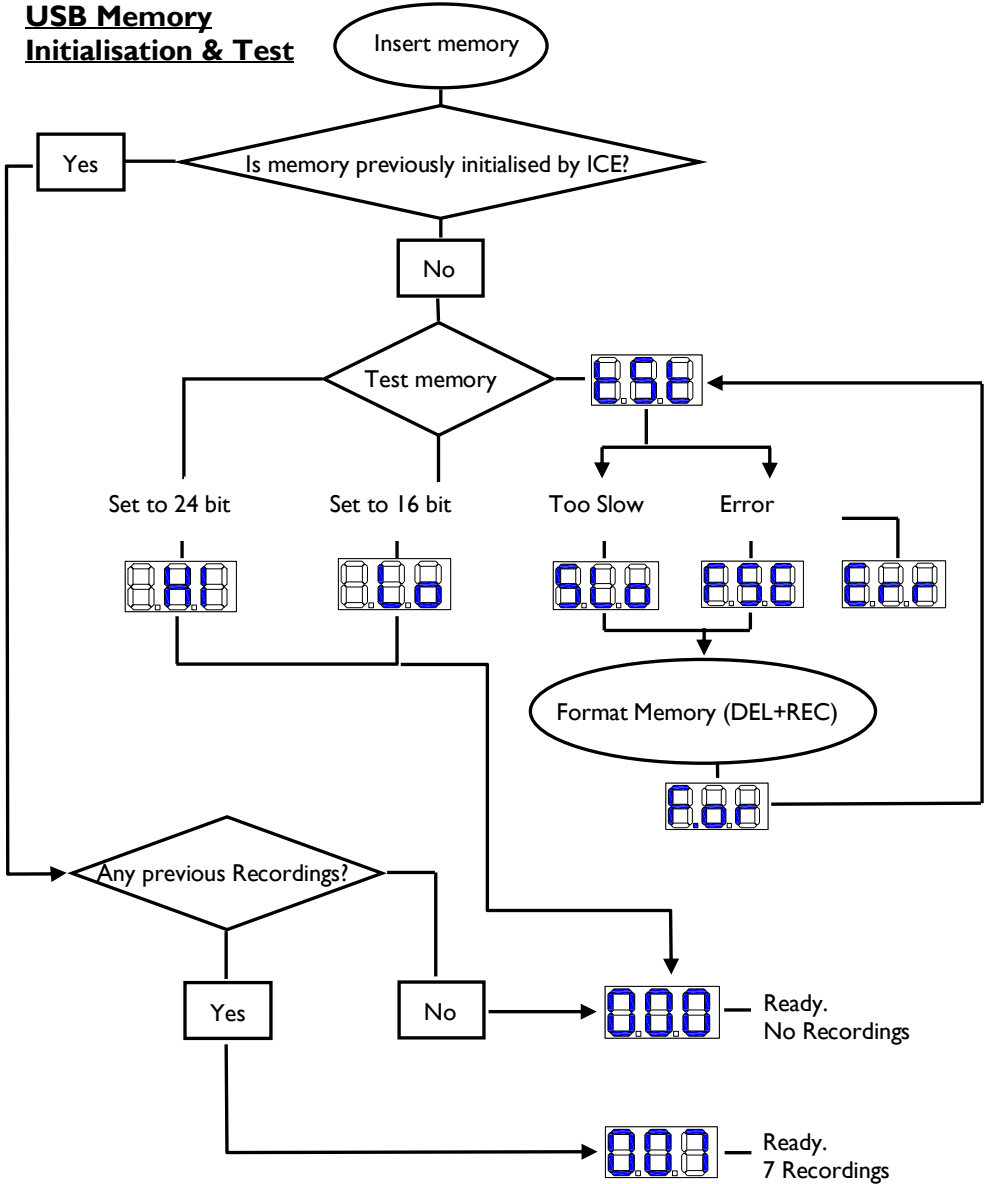

## RECORDING DIRECT TO USB MEMORY

### Short press button functions

\* Rec = Recording mode; Pls = Playlist mode

Button	State	Mode	Comment	Display
PLAY/STOP	Idle	Rec/Pls *	Play selected song	Song no.
PLAY/STOP	Playing	Rec/Pls	Stop playing	Song no.
PLAY/STOP	Recording	Rec	Stop recording	Song no.
REC	Idle	Rec	Start recording	Song no.
PREV	Idle	Rec/Pls	Previous song	Song no.
PREV	Playing	Rec/Pls	Pre-selects previous song	Song no. (blinks)
NEXT	Idle	Rec/Pls	Next song	Song no.
NEXT	Playing	Rec/Pls	Pre-selects next song	Song no. (blinks)
DEL	Idle	Rec	Delete current song Press PLAY/STOP to confirm Any other key to abort.	dEL (blinks before confirmation)
TIME	Any	Rec/Pls	Show remaining record time if below 99mins.	rxX (minutes)

### Long press button functions (>1 second)

Button	State	Mode	Comment	Display
PLAY/STOP	Playing	Pls	Toggle playlist mode Continuous play mode Single song mode	Dot 1 on Dot 1 off
TIME	Any	Rec/Pls	Display sample rate	44.1 or 48.0

### Long press multiple button functions (>1 second)

Button	State	Mode	Comment	Display
TIME+NEXT	Not Recording	Rec/Pls	Toggle Record/Playlist mode Recording mode Playlist mode	Xxx (Song no.) Pxx
DEL+REC	Any	Rec/Pls	Format USB memory Press PLAY/STOP to confirm Any other key to abort	For Dots flash

## RECORDING DIRECT TO USB MEMORY

### More notes on USB memory recording user interface

#### **Slow Memory write speed (Display Slo)**

If you get the Slo message when a new USB memory device is inserted, try re-formatting the device using ICE-16. Press and hold DEL + REC then confirm the formatting with the PLAY/STOP key. ICE will set the cluster size correctly and re-test the memory speed. If, after re-formatting, the Slo message is displayed again, then the memory device should not be used. The Formatting process normally takes around 30 seconds, but could take longer depending on the speed and size of the memory.

#### **24 bit vs 16 bit resolution (Display Hi or Lo)**

USB Hard drives are generally faster than USB stick memory devices and allow ICE-16 to record in Hi resolution 24 bit mode. USB stick memory, although convenient will usually be automatically set to 16 bit resolution .

#### **USB memory recording sample rate (Display 44.1, 48.0, 88.2 or 96.0)**

For recording 16 channels simultaneously, the sample rate must be either 44.1kHz or 48kHz. You can check the sample rate by holding down the TIME button.

You can change the sample rate by holding down the TIME button and pressing either the NEXT or PREV buttons.

**Warning! Doing this while recording WILL change the sample rate. It is best to select it before recording and leave it set.**

Note that you can select higher sample rates of 88.2kHz and 96kHz, but only 8 channels will be recorded at these rates.

#### **USB memory recording dropouts (Display dxx)**

If there is a problem with the USB memory speed or quality, an interruption or dropout may occur. This could be for an undefined number of samples. Should this occur the message dxx will be displayed momentarily (xx is the current number of dropouts that have occurred during the recording). At the end of the recording, the finalisation process may take a little longer and the message dxx will be displayed showing the total number of dropouts during that recording. This message will not be displayed if another song or recording is selected.

**To avoid dropouts use a good quality USB hard drive preferably, or a fast USB memory stick of a type validated by the Allen & Heath test team.**

(see [www.allen-heath.com](http://www.allen-heath.com))

#### **Recording Time (Display rxx)**

The time remaining will be displayed when TIME is pressed once (if over 99 minutes 99 will be displayed). The display will count down the seconds from 99 seconds remaining and when the memory is full, the display will flash "Full".

# RECORDING DIRECT TO USB MEMORY

## Notes on USB memory recording file structure

After formatting, the file structure on your USB memory device will look like this when connected to your computer (removed from ICE and plugged into your computer):

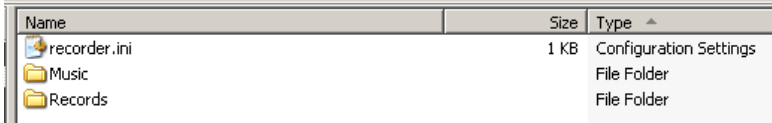

Name	Size	Type
recorder.ini	1 KB	Configuration Settings
Music		File Folder
Records		File Folder

The recorder.ini file stores the initialisation settings for the device. Do not modify this file! The Music folder is where you can copy .wav files to for playlist playback, for example if you require background music at an event or wish to listen to an individual or consecutive list of .wav audio files.

The Records folder is where your ICE-I6 recordings are stored, under sub folders Song\_01 for the first recording, Song\_02 for the second and so on.

The individual channel .wav files will be named chan\_01.wav to chan\_16.wav.

You can copy or import these to your DAW system for mixing and editing, or you can play them back to the individual outputs on the ICE-I6.

Note that the channel order in which the files are played to the outputs is dependent on the order in which files were created in the folder rather than the name. This is useful to know if you want to change the file order, you can copy files to a new Song folder in the order you require.

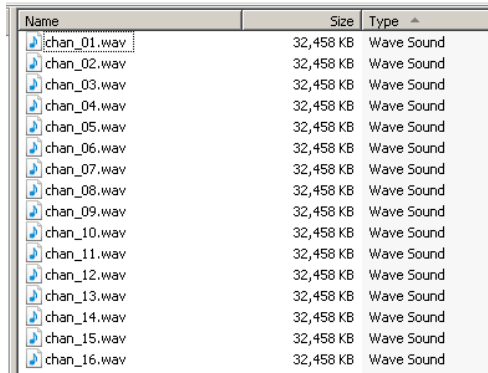

Name	Size	Type
chan_01.wav	32,458 KB	Wave Sound
chan_02.wav	32,458 KB	Wave Sound
chan_03.wav	32,458 KB	Wave Sound
chan_04.wav	32,458 KB	Wave Sound
chan_05.wav	32,458 KB	Wave Sound
chan_06.wav	32,458 KB	Wave Sound
chan_07.wav	32,458 KB	Wave Sound
chan_08.wav	32,458 KB	Wave Sound
chan_09.wav	32,458 KB	Wave Sound
chan_10.wav	32,458 KB	Wave Sound
chan_11.wav	32,458 KB	Wave Sound
chan_12.wav	32,458 KB	Wave Sound
chan_13.wav	32,458 KB	Wave Sound
chan_14.wav	32,458 KB	Wave Sound
chan_15.wav	32,458 KB	Wave Sound
chan_16.wav	32,458 KB	Wave Sound

If you delete any files from a Song folder the remaining files will play in order of creation in that folder to the outputs from output 1 but with no gap. In other words, if you deleted chan\_01.wav from the folder above and played the song on ICE-I6 then chan\_02 to chan\_16 would play to outputs 1 to 15.

## PLAYLIST MODE

You can use ICE-16 to play audio music files (.wav) from the Music folder on your USB memory device for situations such as background music, pre-show & interval music, sound effects, or situations where a very large amount of consecutive audio needs to be played. The stereo .wav files will be played to outputs 1 & 2.

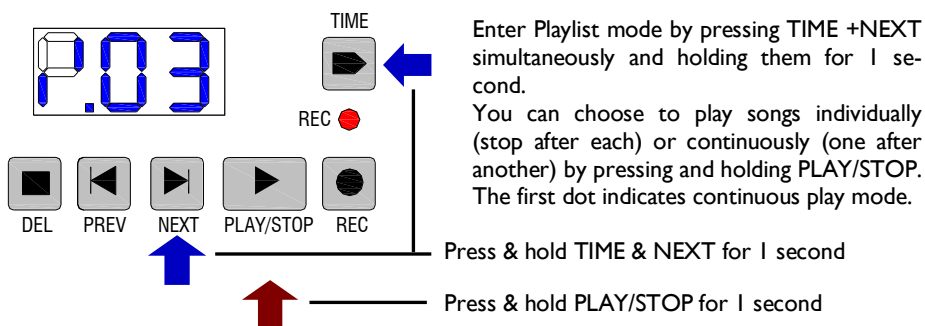

Use the PREV & NEXT buttons to select (or pre-select if playing) a song.

Note. Each time you select and play a new song remember to hold down PLAY/STOP for 1 second if you wish to remain in continuous play mode.

In continuous play mode, at the end of the last song or track in the music folder, the player will start to play the first song or track in the folder.

To exit Playlist mode and enter Record mode either press TIME + NEXT at any point, or stop the playback and press REC to start a recording.

# INSTALLING THE FIREWIRE DRIVERS

## Connecting to a computer via FireWire.

The ICE-16 can either be connected to a computer for streaming digital audio via FireWire or USB, or it can be used as a standalone recording device. Here we describe the FireWire connection and driver installation.

### IMPORTANT!

**Ensure your ICE-16 is NOT connected to the computer before installing drivers.**

## WINDOWS Computers:

### Download the FireWire Driver.

First you will need to download the latest driver package from:

[www.allen-heath.com](http://www.allen-heath.com)

Once you have the downloaded the folder containing the driver, save it to your pc.

Locate the folder and open it to view the files. Double click Setup.exe.

## INSTALLATION ON WINDOWS XP SHOWN

The Setup Wizard will open.  
Follow the instructions.....

Click Next



Click Install

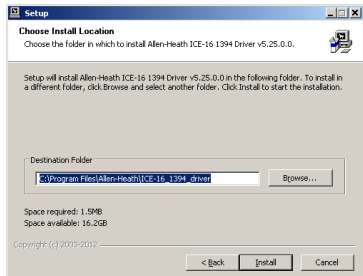

Click Continue Anyway

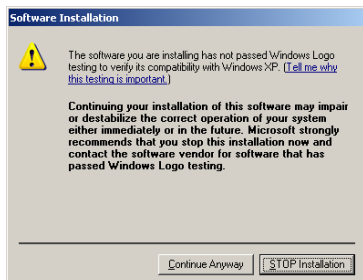

# INSTALLING THE FIREWIRE DRIVERS (PC)

At this point connect the ICE-16 (either FireWire port) to your computer using a commercially available IEEE1394 FireWire cable. Then switch on the ICE-16.

**In order to comply with EMC/FCC performance standards, a FireWire lead with moulded ferrite filters at each end of the cable must be used.**

**For more information and a list of recommended cables please see:**  
**[www.allen-heath.com](http://www.allen-heath.com)**

When asked to connect to Windows Update, click No, not this time, then click Next.

Click Install.....automatically  
Click Next

Click Finish

The Driver should then be installed on your computer.

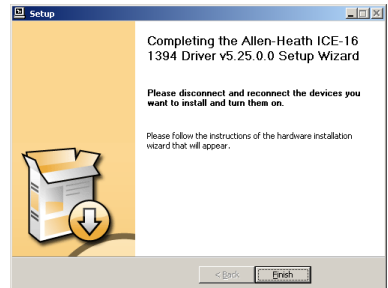
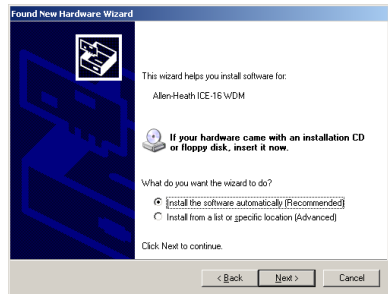
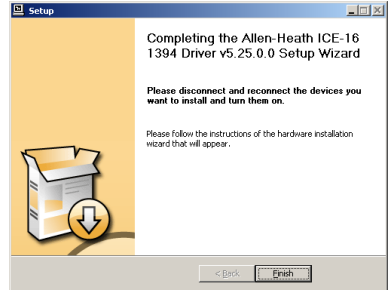



# THE FIREWIRE DRIVER CONTROL PANEL (PC)

## FireWire Driver Control Panel Application

An application is installed along with the FireWire driver on Windows personal computers which allows control of various aspects relating to the streaming of digital audio via FireWire. The following guide outlines the control panel application.

Open the control panel from either your programs list or by clicking the green FireWire icon in your system tray.

The control panel will open and show any ICE-16 devices connected. You can re-name the device here if you wish. The unique ID number of your device is also displayed. Device status information is displayed at the bottom of the window.

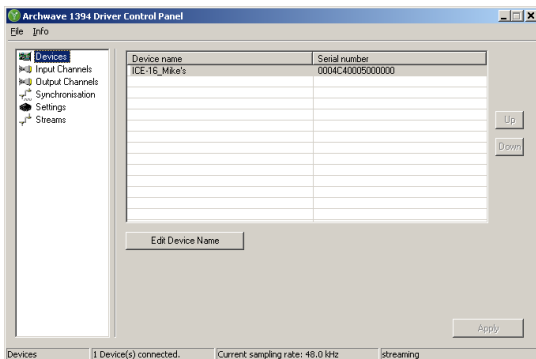

Click Input Channels in the menu pane on the left to view or edit details of the audio channels going to the computer from ICE-16. Here you can edit the channel names and include the device (unit) name in the ASIO display name which will appear in your audio software.

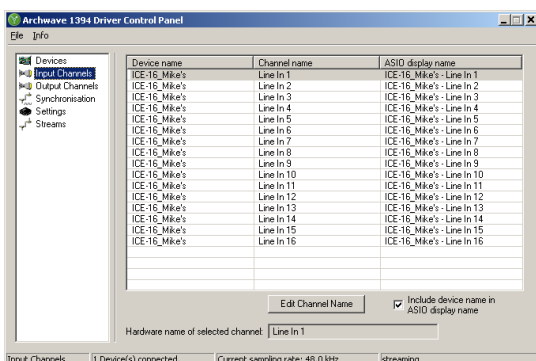

Click Output Channels to view and edit the audio channels going to the ICE-16 from the computer. The names can be edited here as well.

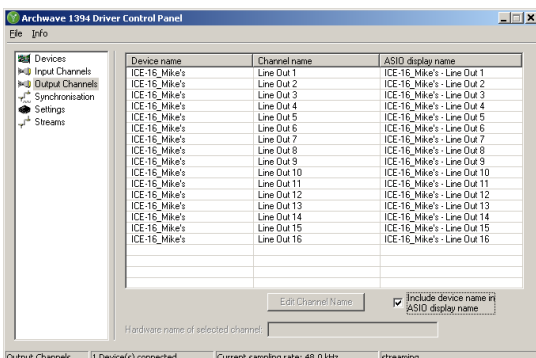

# THE FIREWIRE DRIVER CONTROL PANEL (PC)

Click Synchronisation to view the status and access control over the sync options.

The clock master can be set to be the ICE-16 internal clock (recommended) or the pc driver.

The sample rate can be selected to be set manually or by the clock master. Manually is recommended as a default, the sample rate can still be set by your DAW in this setting.

The sample rate option box will display the current sample rate and a drop down selection will show available rates if in manual set mode.

**Important! If you change Synchronisation Mode to “Slave to Audio Clock Master”, ensure you swap back to “Device Internal Clock” before using ICE for USB direct recording.**

The Settings page of the control panel shows the buffer depths for the audio data stream and the ASIO and Windows driver.

You can adjust the settings using the sliders to increase or decrease the buffer depth depending on your computer system. For minimum latency use lower buffer depths. Increase them if you experience audio dropouts or clicks.

Click Streams in the menu pane to view details of the digital audio data stream and synchronisation connectors.

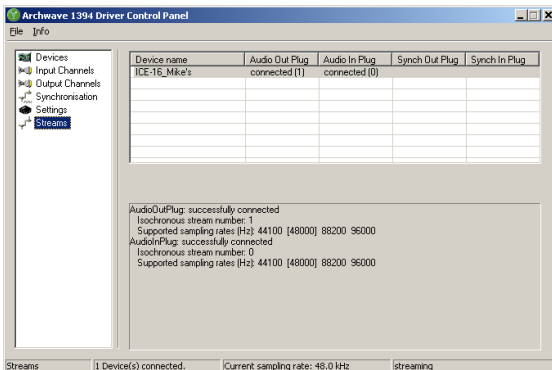
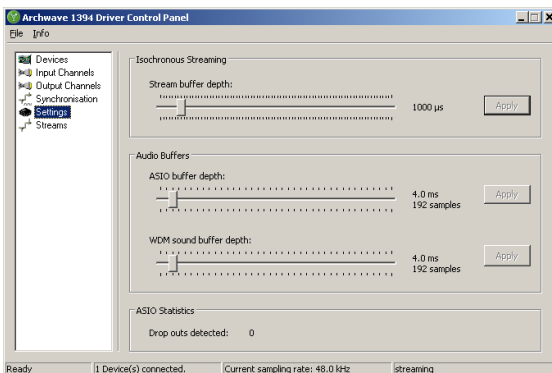
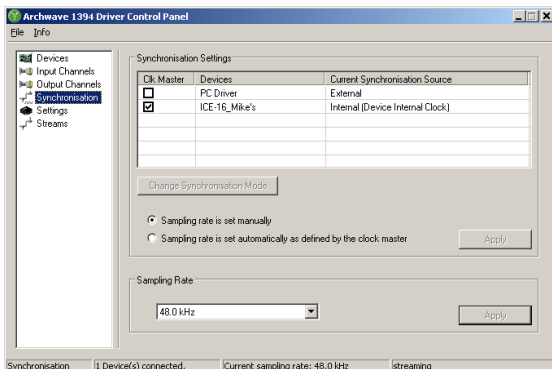

# INSTALLING THE USB DRIVERS (PC)

## Connecting to a computer via USB 2.0

The ICE-16 can either be connected to a computer for streaming digital audio via Firewire or USB 2.0, or it can be used as a standalone recording device. Here we describe the USB 2.0 connection and driver installation.

### IMPORTANT!

**Ensure your ICE-16 is NOT connected to the computer before installing drivers.**

## WINDOWS Computers:

### Download the USB Driver.

First you will need to download the latest driver package from:

[www.allen-heath.com](http://www.allen-heath.com)

Once you have the downloaded the folder containing the driver and save it to your pc. Locate the folder and open it to view the files. Double click Setup.exe.

The Setup Wizard will open.  
Follow the instructions.....

Click Next

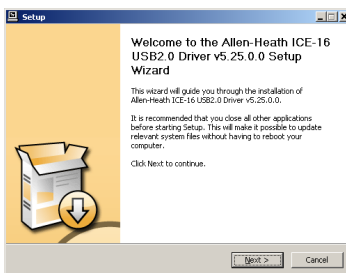

Click Install

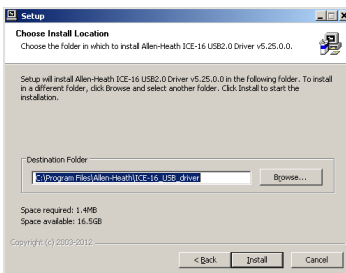

Click Continue Anyway

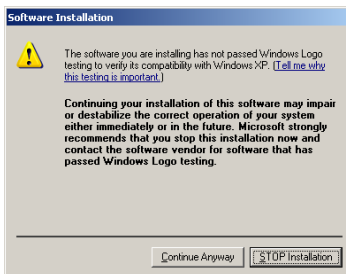

# INSTALLING THE USB DRIVERS (PC)

Connect the ICE-16 to your computer using a standard commercially available USB (A to B) cable.  
Switch on the ICE-16.



Click Next

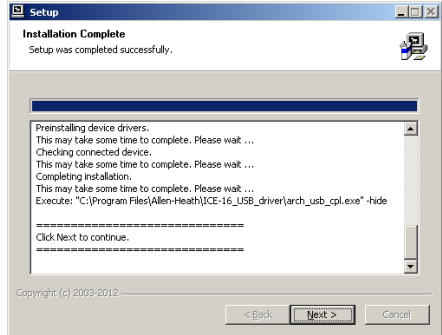

You may find an additional dialogue window about Logo testing, sometimes behind another window!  
Click Continue anyway in order to finish the installation.

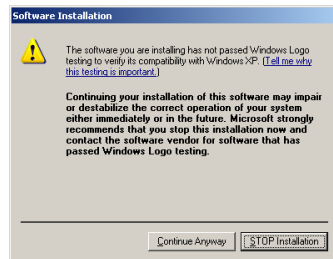

Click Finish to exit the installation wizard.

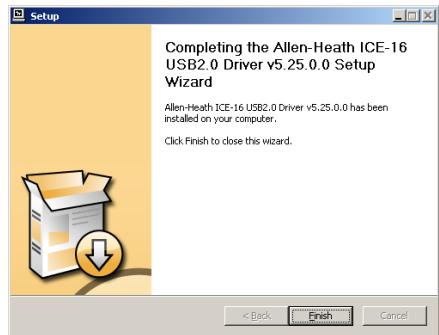

The USB driver should now be installed on your computer.

# THE USB DRIVER CONTROL PANEL (PC)

## USB 2.0 Driver Control Panel Application

An application is installed along with the USB driver on Windows™ computers which allows control of various aspects relating to the streaming of digital audio via USB 2.0. The following guide outlines the control panel application.

Open the control panel from either your programs list or by clicking the purple USB icon in your system tray. The control panel will open and show any ICE-16 device connected. You can re-name the device here if you wish. The unique ID number of your device is also displayed. Device connection status is displayed at the bottom of the window.

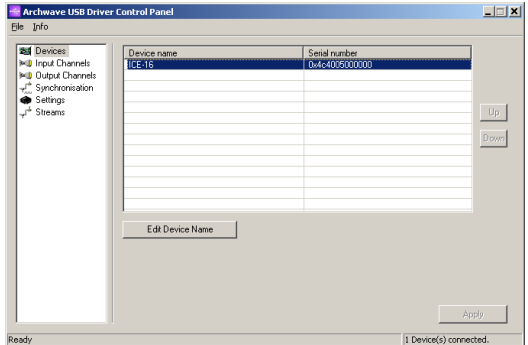

Click Input Channels in the menu pane on the left to view or edit details of the audio channels going to the computer from ICE-16. Here you can edit the channel names and include the device (unit) name in the ASIO display name which will appear in your audio software.

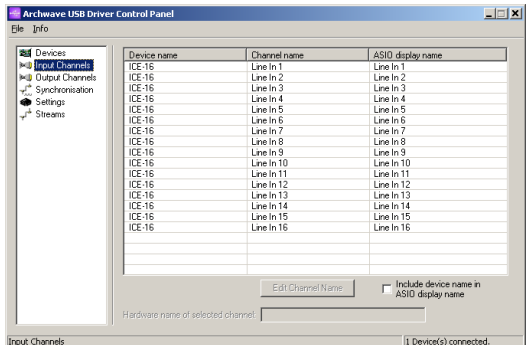

Click Output Channels to view and edit the audio channels going to the ICE-16 from the computer. The names can be edited here as well.

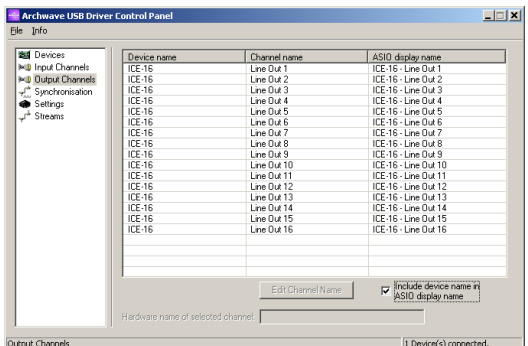

# THE USB DRIVER CONTROL PANEL (PC)

Click Synchronisation to view the status and access control over the sync options.

The clock master can be set to be the ICE-I6 internal clock or the pc driver.

The sample rate can be selected to be set manually or by the clock master. Manually is recommended as a default, the sample rate can still be set by your DAW in this setting.

The sample rate option box will display the current sample rate and a drop down selection will show available rates if in manual set mode.

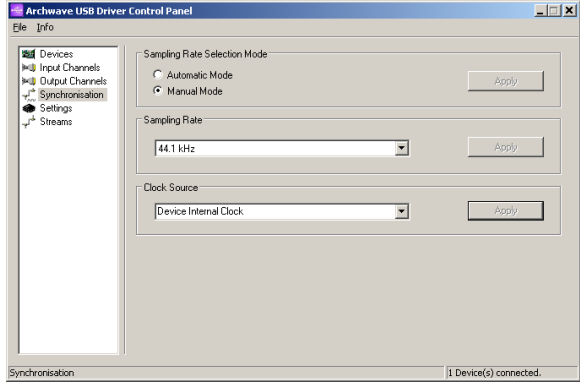

The Settings page of the control panel shows the buffer depths for the audio data stream and the ASIO and Windows driver.

You can adjust the settings using the sliders to increase or decrease the buffer depth depending on your computer system. For minimum latency use lower buffer depths. Increase them if you experience audio dropouts or clicks.

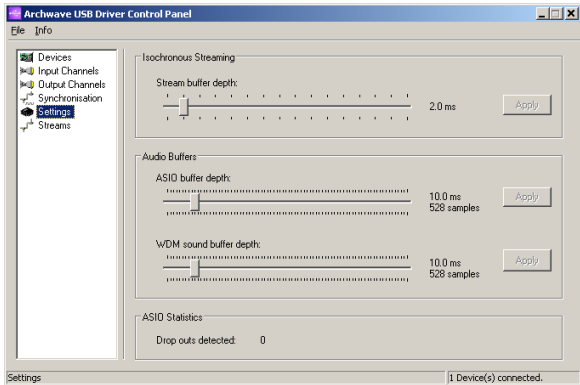

Click Streams in the menu pane to view details of the digital audio data stream and synchronisation connectors.

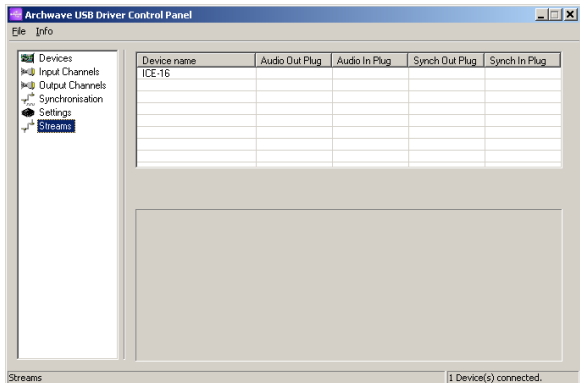

# CONNECTING ICE-16 TO A MAC COMPUTER

## SNOW LEOPARD SHOWN

ICE-16 is Core Audio compliant so there are no drivers required for Mac computers. Simply connect your ICE-16 to your Mac using either a FireWire or USB 2.0 cable and open Audio/MIDI devices/Audio Devices to view the connected devices and settings. You can select the clock source and change the sample rate.

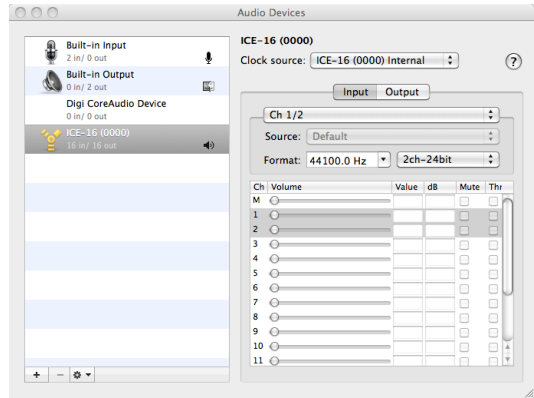

If you are using a FireWire connection, you can add a second ICE-16 connected via FireWire to the first. Here you can see two ICE-16s, serial number 0000 and 0001. You can set which is the clock master—here it is set to 0000 (both devices have this as their clock source)

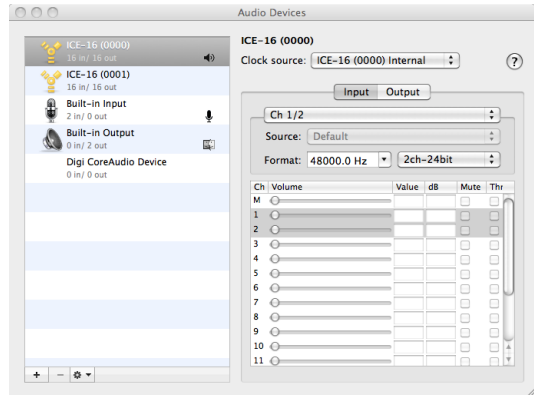

You can combine the two ICEs as one aggregate device for use in DAWs such as Logic or Pro Tools. To do this click the + button at the bottom left of the window and click Use for the two ICE-16s. This will expand the number of inputs and outputs available to 32.

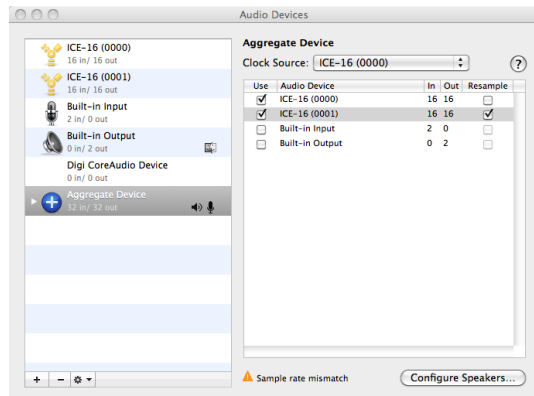

# CONNECTING ICE-16 TO A MAC COMPUTER

## MOUNTAIN LION SHOWN

Here you can see two ICE-16 devices connected to a Mac running Mountain Lion. An Aggregate device has also been configured at the bottom of the list and named ICE-32.

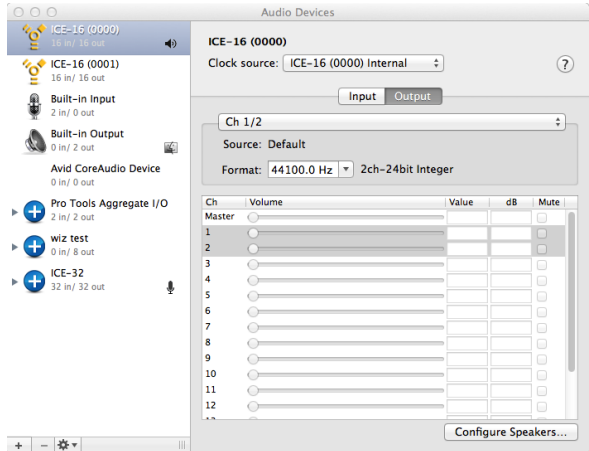

You can set your iTunes playback to any of the device channels by clicking Configure Speakers. Here we have chosen the ICE-32, channels 1 & 2, but this could be any channels up to channels 31- 32 (in stereo mode).

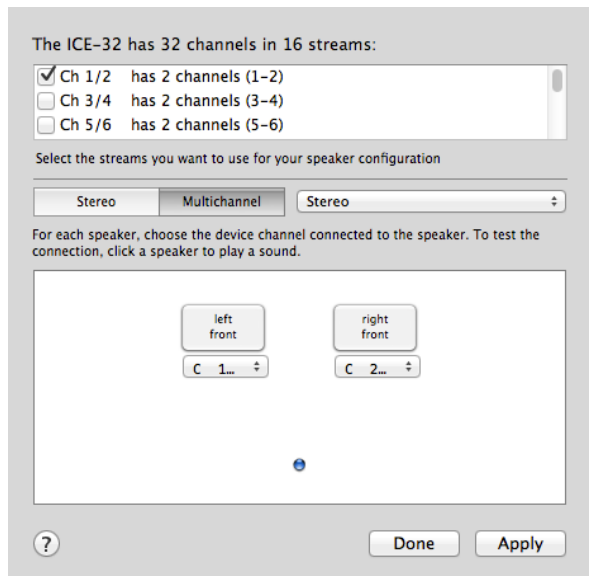



## **SYNCHRONISING MORE THAN ONE ICE-16**

**This feature is due to be released in early 2013 with a firmware update. If you wish to synchronise more than one ICE-16 for direct to USB memory please refer to [www.allen-heath.com](http://www.allen-heath.com) for information.**

**This page is therefore intentionally left blank.**

## **SYNCHRONISING MORE THAN ONE ICE-16**

**This page is intentionally left blank.**

# WIRING MIXERS TO ICE-16

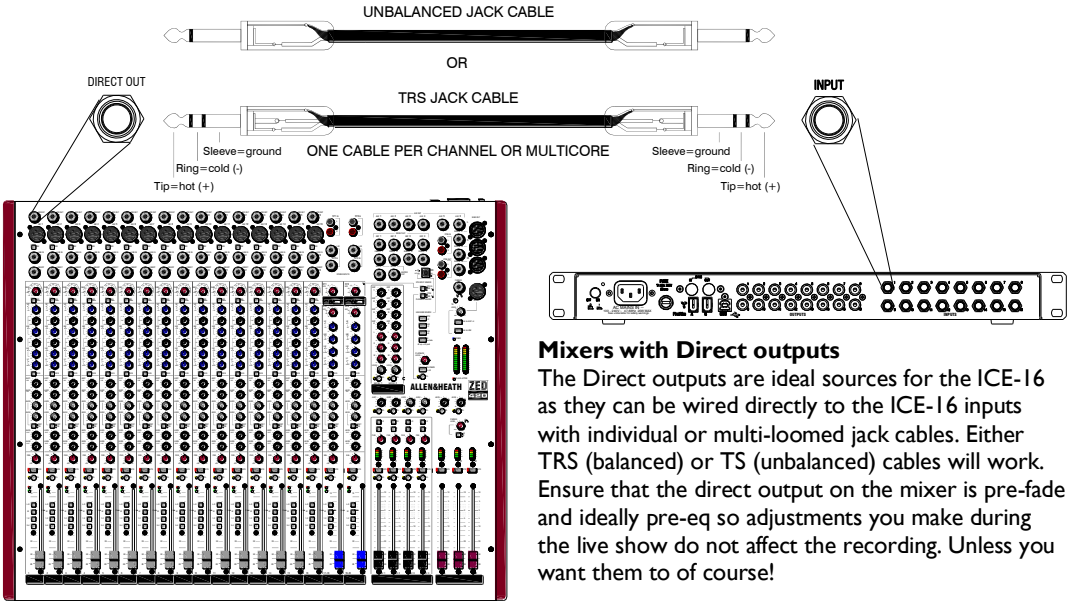

## RCA Phono to L+R Jack adaptor

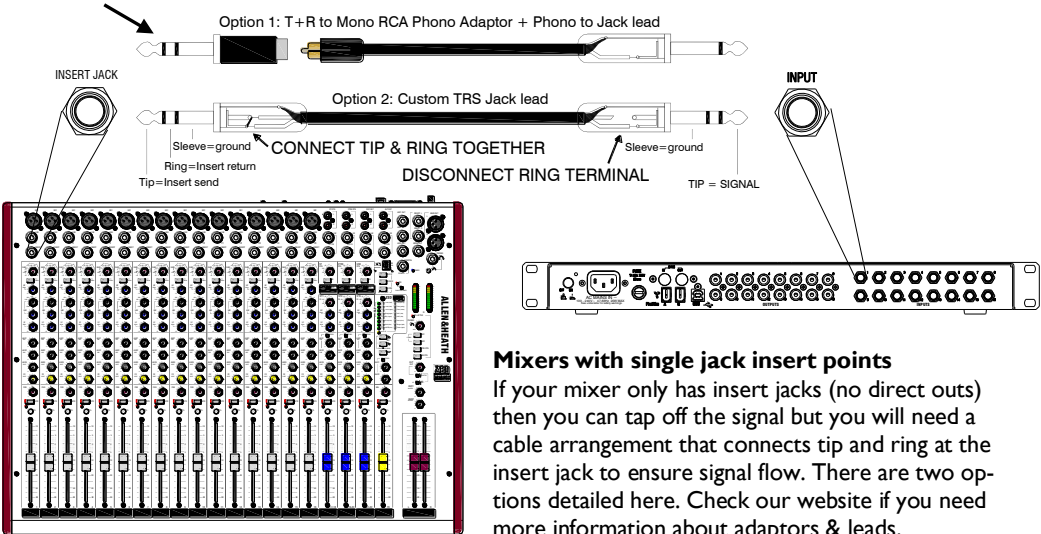

# SPECIFICATIONS

## Operating Levels

Operating Levels	
<b>Input</b>	
Mono input 1/4" TRS Jack socket.	0dBu nominal (+20dBu maximum)
<b>Output</b>	
Mono output RCA Phono socket	0dBu nominal (+20dBu maximum)
Headphones 1/4" TRS and 3.5mm Jack sockets (mono)	150mW minimum 30 ohms to 300ohms

## Frequency Response

Input to output	+0.25/-0.5dB 10Hz to 20kHz.
-----------------	-----------------------------

## THD+n

Input to output, 0dBu 1kHz 48kHz Sample rate	0.006% (20-22kHz)
Input to output, +10dBu 1kHz 48kHz Sample rate	0.0045% (20-22kHz)
Input to output, +20dBu 1kHz 48kHz Sample rate	0.005% (20-22kHz)
Input to output, 0dBu 10kHz 48kHz Sample rate	0.005% (20-22kHz)
Input to output, +10dBu 10kHz 48kHz Sample rate	0.004% (20-22kHz)
Input to output, +20dBu 10kHz 48kHz Sample rate	0.013% (20-22kHz)

## Headroom

Analogue Headroom from nominal (0dBu)	20dB
Digital Headroom from nominal (-20dBFS)	20dB

## Channel Meter LEDs

Signal LED (Green)	-22dBu (-42dBFS)
Hi Level (Red)	+14dBu (-6dBFS)

## Noise

Output DAC noise (Input routed through to output)	-86dBu (20-22kHz)
Output DAC noise (output volume to minimum)	-90dBu (20-22kHz)

## ADC & DAC

ADC & DAC word length	24 bit
Sample Rate	44.1, 48, 88.2, 96 kHz
ADC Dynamic range	114dB (A Weighted)
DAC Dynamic range	118dB (A Weighted)

# SPECIFICATIONS

## FireWire Streaming

IEEE1394 standard	AS400
Number of ICE-16 devices on bus	2 maximum
Audio data	24 bit up to 96kHz
Synchronisation	Internal clock or bus

## USB Streaming

USB standard	USB 2.0
Number of ICE-16 devices on bus	1 maximum
Audio data	24 bit up to 96kHz
Synchronisation	Internal clock or bus

## USB Memory Direct Recording

Resolution 16 channels, High quality media	24 bit 44.1 or 48kHz
Resolution 16 channels, Low quality media	16 bit 44.1 or 48kHz
Sample rates allowed with channel count reduced to 8	88.2 & 96kHz
Data rate at 16 bit 44.1kHz, 16 channels	84.6MB/min (3hours on a 16GB drive)
Data rate at 16 bit 48kHz, 16 channels	92.2MB/min (2h 47m on a 16GB drive)
Data rate at 24 bit 48kHz, 16 channels (use USB hard drive)	138.2MB/min (38h 30m on a 320GB drive)
Maximum file size	4GB (8h 17m single recording 24bit 48kHz)
Maximum supported drive size	8TB

## Computer Compatibility

Windows PC	ASIO & WDM Driver 32 or 64 bit
Mac Computers	Core Audio compliant (no driver required)

Please check [www.allen-heath.com](http://www.allen-heath.com) website for latest information on compatibility with computer operating systems.

# DIMENSIONS

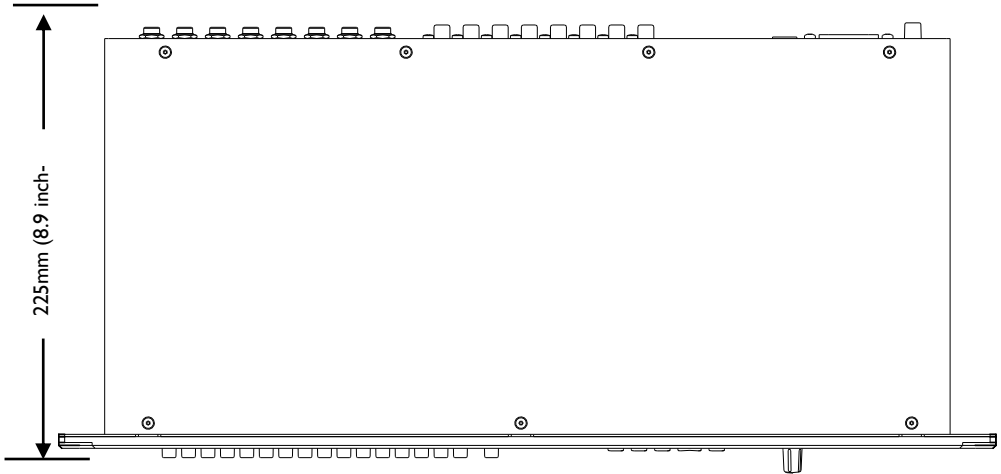
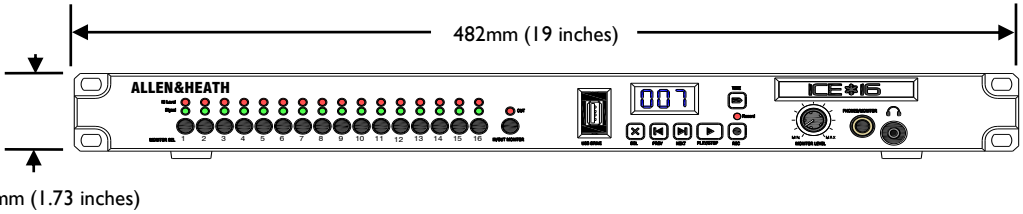

Weight	
Unpacked	3.2kg (7 lb)
Packed	4.4kg (9.7 lb)

## Fitting to a 19" rack



ICE-16 can be fitted to a standard 19" rack using 4 x M6 pan head screws with plastic washers to fix positions shown with arrows above.

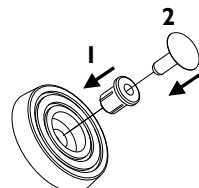

The feet can be fitted for desktop use or left un-fitted if rack mounted. Fit the feet according to the picture. To remove the feet later, prize out the central plastic rivet.

# BLOCK DIAGRAM SCHEMATIC

## ICE-16 SYSTEM BLOCK DIAGRAM

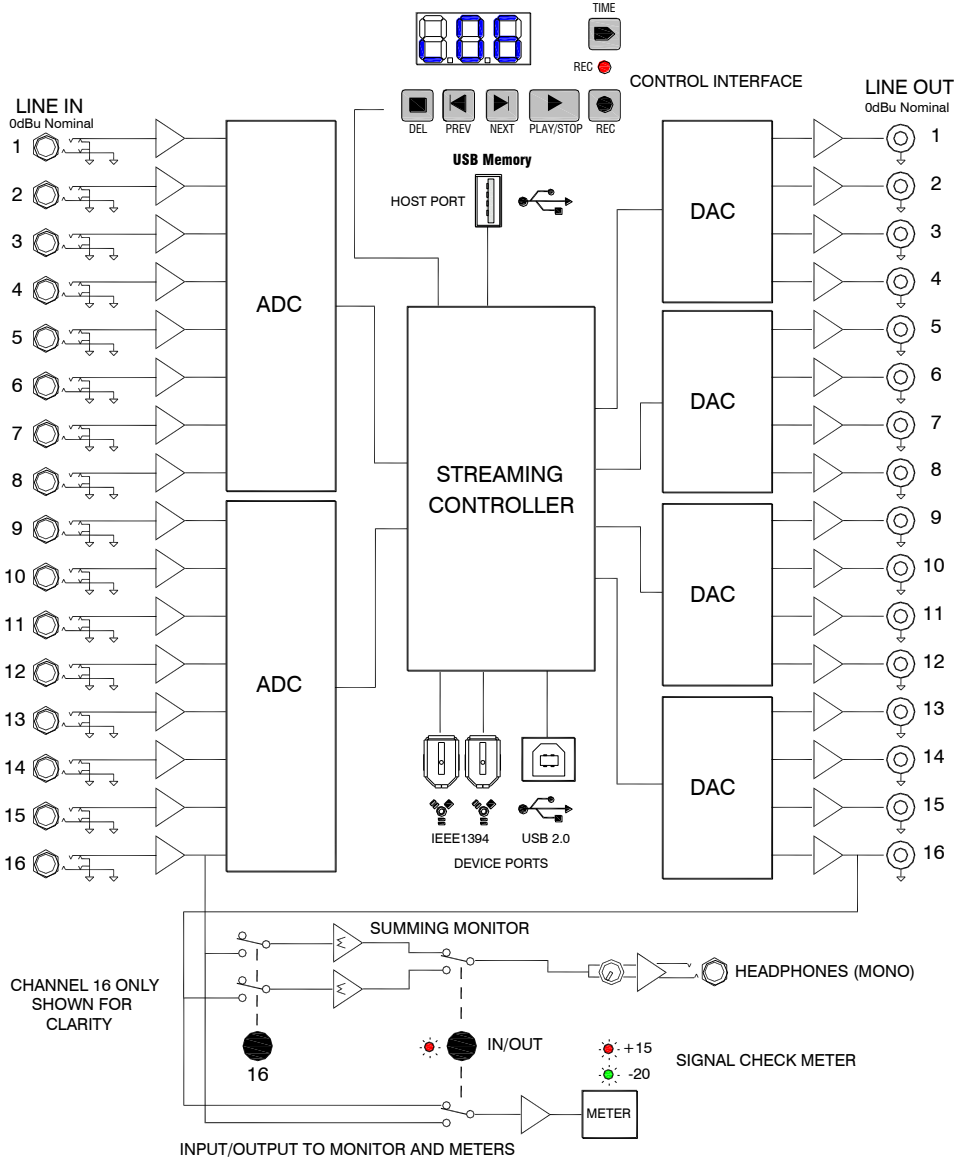

See more products from ALLEN & HEATH at: [www.allen-heath.com](http://www.allen-heath.com)



Large Live Sound mixers — iLive digital, and GL Series

Small Format Live Sound mixers — ZED, MixWizards and PA Series

DJ products — Xone Series

Sound Management Series — iDR Series

### Registering your product

Thank you for buying the Allen & Heath ICE-I6. We hope that you are happy with it and that you enjoy many years of faithful service with it.

Please go to [www.allen-heath.com/register.asp](http://www.allen-heath.com/register.asp) and register your product's serial number and your details. By registering with us and becoming an official Registered User, you will ensure that any warranty claim you might make is actioned quickly and with the minimum delay.

Alternatively, you may either copy or cut off this section of the page, fill in the details, and return it by mail to:

Allen & Heath Ltd, Kernick Industrial Estate, Penryn, Cornwall TR10 9LU, UK

#### **ALLEN&HEATH PRODUCT REGISTRATION**

Thank you for buying an Allen & Heath product. We hope that you're happy with it and that you enjoy many years of faithful service with it.

SERIAL NUMBER
---------------

Please return this section of the card by mail and retain the other part for your records. You can also register online at [www.allen-heath.com](http://www.allen-heath.com). Thanks for your help.

Your Name: \_\_\_\_\_

Company Name: \_\_\_\_\_

Address 1: \_\_\_\_\_

Address 2: \_\_\_\_\_

Town/City: \_\_\_\_\_ County/State: \_\_\_\_\_

Country: \_\_\_\_\_ Postcode/Zip: \_\_\_\_\_

Telephone: \_\_\_\_\_

Email: \_\_\_\_\_

Why did you choose this console? \_\_\_\_\_

Which other products did you consider before choosing A&H? \_\_\_\_\_

Is there any thing you would like to improve on this mixer? \_\_\_\_\_

What audio magazines do you read? \_\_\_\_\_

If you were going to design a mixer for your work, what are the 6 most important features it should have (in order of importance)

1	2
3	4
5	6

We may use the information you provide to inform you of future product developments. We will not give or sell this data to third parties. Please indicate with an 'x' if you do not wish to receive any further communications from us.



# NOTES





