



  
STAIRVILLE

AF-40 DMX  
fog machine

Musikhaus Thomann  
Thomann GmbH  
Hans-Thomann-Straße 1  
96138 Burgebrach  
Germany  
Telephone: +49 (0) 9546 9223-0  
E-mail: [info@thomann.de](mailto:info@thomann.de)  
Internet: [www.thomann.de](http://www.thomann.de)

13.02.2018, ID: 307680

## Table of contents

<b>1</b>	<b>General notes</b> .....	<b>4</b>
<b>2</b>	<b>Safety instructions</b> .....	<b>8</b>
<b>3</b>	<b>Features</b> .....	<b>15</b>
<b>4</b>	<b>Installation</b> .....	<b>16</b>
<b>5</b>	<b>Starting up</b> .....	<b>17</b>
<b>6</b>	<b>Connections and controls</b> .....	<b>19</b>
<b>7</b>	<b>Operating</b> .....	<b>24</b>
	7.1 Remote control functions.....	26
	7.2 Function in 'DMX' mode.....	27
<b>8</b>	<b>Technical specifications</b> .....	<b>29</b>
<b>9</b>	<b>Plug and connection assignments</b> .....	<b>30</b>
<b>10</b>	<b>Troubleshooting</b> .....	<b>31</b>
<b>11</b>	<b>Cleaning</b> .....	<b>33</b>
<b>12</b>	<b>Protecting the environment</b> .....	<b>35</b>

# 1 General notes





This user manual contains important information on safe operation of the device. Read and follow all safety notes and all instructions. Save this manual for future reference. Make sure that it is available to all persons using this device. If you sell the device to other users, be sure that they also receive this manual.

Our products are subject to a process of continuous development. We therefore reserve the right to make changes without notice.

## Symbols and signal words

This section provides an overview of the symbols and signal words used in this user manual.

Signal word	Meaning
<b>DANGER!</b>	This combination of symbol and signal word indicates an immediate dangerous situation that will result in death or serious injury if it is not avoided.
<b>WARNING!</b>	This combination of symbol and signal word indicates a possible dangerous situation that can result in death or serious injury if it is not avoided.
<b>CAUTION!</b>	This combination of symbol and signal word indicates a possible dangerous situation that can result in minor injury if it is not avoided.
<b>NOTICE!</b>	This combination of symbol and signal word indicates a possible dangerous situation that can result in material and environmental damage if it is not avoided.

Warning signs	Type of danger
 A yellow triangular warning sign with a black border and a black lightning bolt symbol in the center.	Warning – high-voltage.
 A yellow triangular warning sign with a black border and a black flame symbol in the center.	Warning – flammable substances.
 A yellow triangular warning sign with a black border and three wavy black lines representing heat in the center.	Warning – hot surface.
 A yellow triangular warning sign with a black border and a black symbol of a crane hook lifting a rectangular load in the center.	Warning – suspended load.
 A yellow triangular warning sign with a black border and a black 'X' symbol in the center.	Warning – harmful or irritating substances.

Warning signs	Type of danger
	Warning – danger zone.

## 2 Safety instructions

### Intended use

This device is intended to be used to produce artificial fog by vaporising fog fluid. Use the device only as described in this user manual. Any other use or use under other operating conditions is considered to be improper and may result in personal injury or property damage. No liability will be assumed for damages resulting from improper use.

This device may be used only by persons with sufficient physical, sensorial, and intellectual abilities and having corresponding knowledge and experience. Other persons may use this device only if they are supervised or instructed by a person who is responsible for their safety.

### Safety



#### **DANGER!**

#### **Danger for children**

Ensure that plastic bags, packaging, etc. are disposed of properly and are not within reach of babies and young children. Choking hazard!

Ensure that children do not detach any small parts (e.g. knobs or the like) from the unit. They could swallow the pieces and choke!

Never let children unattended use electrical devices.





**DANGER!**

**Electric shock caused by high voltages inside**

Within the device there are areas where high voltages may be present. Never remove any covers.

There are no user-serviceable parts inside.

Do not use the device if covers, protectors or optical components are missing or damaged.



**DANGER!**

**Electric shock caused by short-circuit**

Always use proper ready-made insulated mains cabling (power cord) with a protective contact plug. Do not modify the mains cable or the plug. Failure to do so could result in electric shock/death or fire. If in doubt, seek advice from a registered electrician.



**WARNING!**

**Risk of burns from flammable liquids**

The use of flammable liquids in this device may cause severe burns and damage to property.

Always use approved fog fluids. Never fill flammable liquids into the tank of the device.



**WARNING!**

**Risk of burns**

The generated fog at the fog nozzle is hot and can cause burns. Occasionally hot fluid drops may escape from the nozzle.

The distance of persons and objects to the fog nozzle must be at least fifty centimetre (1.6 feet).

Do not touch the fog nozzle during and shortly after operation. It becomes very hot and may cause burns even several hours after switching off the device.



**WARNING!**

**Risk of slipping caused by condensation**

Fog machines can produce condensation. Do not direct the fog to floors. Floors and surfaces can become slippery by condensed fog.

Check at regular intervals whether it is possible to walk on the floors without a slipping hazard, and, if necessary, remove the condensation.



**WARNING!**

**Health hazard caused by fog fluid handling**

Fog fluid does contain glycols complying with the regulations for foodstuffs. However, it may be harmful if swallowed.

Do not induce vomiting. Seek medical advice immediately. Keep fog fluid in a safe place. If the fog fluid comes into contact with eyes rinse thoroughly with water.



**CAUTION!**

**Possible respiratory problems**

The device can be operated safely only with the approved fog fluid. The use of other fluids can release toxic gases. Claims for damages caused by the use of non-approved fluids shall be excluded.

Do not create fog in closed or poorly ventilated areas.

Do not expose persons with health problems (such as allergic respiratory conditions, asthma) to artificial fog.



**NOTICE!**

**Risk of fire**

Do not block areas of ventilation. Do not install the device near any direct heat source. Keep the device away from naked flames.



**NOTICE!**

**Operating conditions**

This device has been designed for indoor use only. To prevent damage, never expose the device to any liquid or moisture. Avoid direct sunlight, heavy dirt, and strong vibrations.



**NOTICE!**

**Power supply**

Before connecting the device, ensure that the input voltage (AC outlet) matches the voltage rating of the device and that the AC outlet is protected by a residual current circuit breaker. Failure to do so could result in damage to the device and possibly injure the user.

Unplug the device before electrical storms occur and when it is unused for long periods of time to reduce the risk of electric shock or fire.

### **General information about how to safely operate fog machines and hazers**

The device was designed for use in professional event technology and works reliably when used properly. Observe the following information:

- Follow all warnings in these operating instructions.
- Never leave the device running without supervision.
- The device is not suitable for use in private households or as a child's toy.
- Place the device on a stable, fire-proof basis that is at least twice as large as the device.
- Maintain a safety distance of 1 m to flammable materials.
- The device is not intended for suspended assembly (the so-called "flying operation").
- During operation, ensure that the visibility in the room does not fall below 2 m so that everyone in the room can still orient themselves safely.
- The haze or mist generated by the device may trigger smoke alarms.

### 3 Features

This fog machine is suitable for use in clubs, bars, discotheques and on stages

Special features of the device:

- Control via DMX or via the supplied remote control
- Suitable for mobile use due to compact design

## 4 Installation

Unpack and carefully check that there is no transportation damage before using the unit. Keep the equipment packaging. To fully protect the device against vibration, dust and moisture during transportation or storage use the original packaging or your own packaging material suitable for transport or storage, respectively.



### **WARNING!**

#### **Risk of injury caused by falling objects**

Make sure that the installation complies with the standards and rules that apply in your country. Always secure the device with a secondary safety attachment, such as a safety cable or a safety chain.

You can install the device on the wall, the ceiling or on the ground. The device must never be operated in a more than 15° tilted position. The device requires 20 cm clearance at the sides and above.



## 5 Starting up

Create all connections while the device is off. Use the shortest possible high-quality cables for all connections. Take care when running the cables to prevent tripping hazards.



### **NOTICE!**

#### **Possible data transmission errors**

For error-free operation make use of dedicated DMX cables and do not use ordinary microphone cables.

Never connect the DMX input or output to audio devices such as mixers or amplifiers.

### Connections in DMX mode

Connect the DMX input of the device to the DMX output of a DMX controller or another DMX device. Connect the output of the first DMX device to the input of the second one, and so on to form a daisy chain. Always ensure that the output of the last DMX device in the daisy chain is terminated with a resistor ( $110\ \Omega$ ,  $\frac{1}{4}\text{ W}$ ).

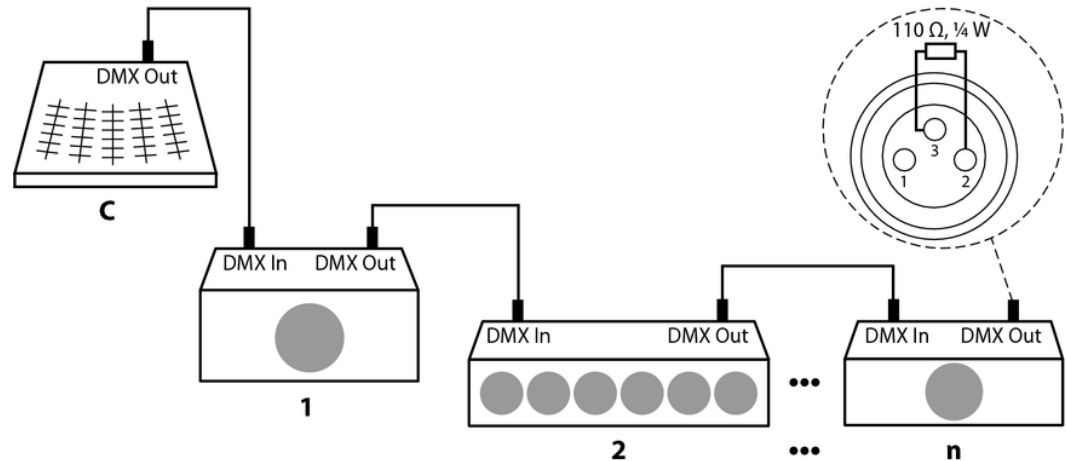

## 6 Connections and controls

### Front panel

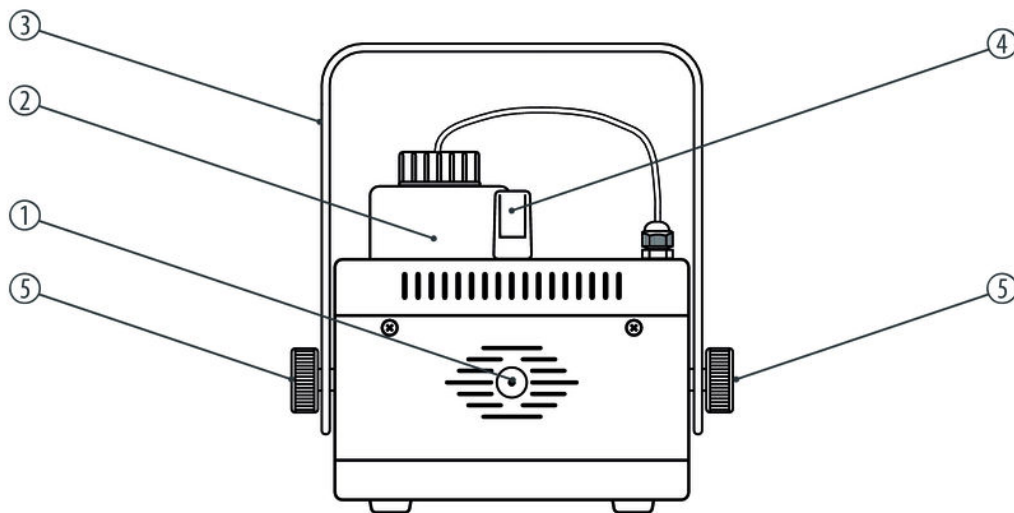

AF-40 DMX

1	Fog nozzle.
2	Fog fluid container with screw-cap
3	Bracket for hanging
4	Carrying handle
5	Locking screws for the mounting bracket

Rear panel

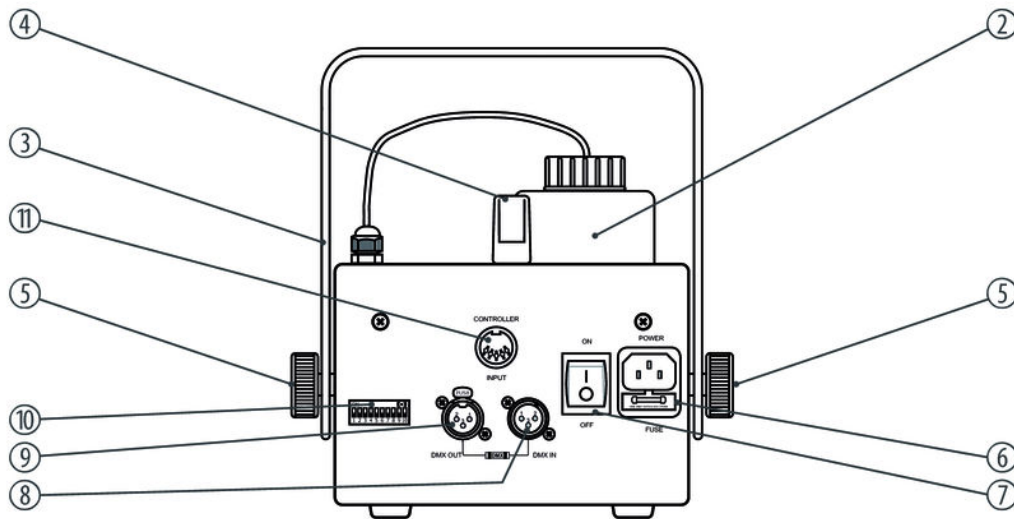

AF-40 DMX

2	Fog fluid container with screw-cap
3	Bracket for hanging
4	Carrying handle
5	Screws for adjusting the bracket
6	<i>[POWER / FUSE]</i> Plug for mains cable with fuse holder
7	Main switch, turns the device on and off
8	<i>[DMX IN]</i> DMX input.
9	<i>[DMX OUT]</i> DMX output
10	DIP switch for setting the DMX address
11	<i>[CONTROLLER]</i> Connection for the remote control

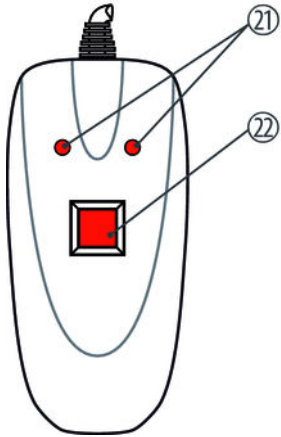
**Remote control**

21 Standby indicators.

These two LEDs indicate that the unit has reached the operating temperature necessary to produce fog.

22 Press this button to emit fog.

## 7 Operating

### Filling the unit



#### **NOTICE!**

#### **Possible damages caused by unsuitable fog fluid**

Fog liquids not approved by the manufacturer may permanently damage the unit.

Only use the fog fluids listed on [www.thomann.de](http://www.thomann.de) and follow their instructions for use.

First, make sure the unit is disconnected from the mains.

Open the screw-cap of the liquid container and fill in the fog fluid. Make sure that no fluid is spilled or gets into the device. The easiest way is using a funnel. The container capacity is 1.25 litre.

Screw the cap firmly back on.



## Turning the unit on



### **NOTICE!**

#### **Fire hazard**

Do not operate the machine unattended.

Connect the device to the mains and switch the device on with the main switch. The unit is heating up.

As soon as the required operating temperature is reached, the control LEDs on the remote light up. The device is now operational.

## Operation

When operating, always ensure that there is sufficient fog fluid in the liquid container to avoid no-load running.

## Turning the unit off

Disconnect the device from the mains. Transport the device only when it is completely cooled down. To avoid leaking fog fluid during transport, you should transport the device only with empty fluid container.

## 7.1 Remote control functions

Press the red button on the remote control to trigger fog burst. Fog is produced as long as you keep this button pressed.

## 7.2 Function in 'DMX' mode

### Setting up the DMX address

The value of the DIP switches 1-9 is binary coded. To set the desired DMX address, set the DIP switches so that the sum of the resulting numbers yields the desired DMX address. Please orient yourself by the following table:

SW9	SW8	SW7	SW6	SW5	SW4	SW3	SW2	SW1	DMX address
0	0	0	0	0	0	0	0	1	1
0	0	0	0	0	0	0	1	0	2
0	0	0	0	0	0	1	0	0	4
0	0	0	0	0	1	0	0	0	8
0	0	0	0	1	0	0	0	0	16
0	0	0	1	0	0	0	0	0	32
0	0	1	0	0	0	0	0	0	64

SW9	SW8	SW7	SW6	SW5	SW4	SW3	SW2	SW1	DMX address
0	1	0	0	0	0	0	0	0	128
1	0	0	0	0	0	0	0	0	256

0: DIP switch is in 'OFF' position. 1: DIP switch is in 'ON' position.

Example: To set the DMX address 10 set DIP switches 2 and 4 to 'ON', all others to 'OFF'. The highest possible DMX address is 511 (all DIP switches to 'ON').

DIP switch 10 has no function.

## DMX assignment

Channel	Value	Function
1	Setting the amount of fog	
	0...255	No fog output (0 %) to maximum fog output (100 %)

## 8 Technical specifications

Heater power	400 W
Fog output	approx. 85 m <sup>3</sup> /min
Fluid container capacity	1.25 l
Warm-up time	approx. 5 min
Operating supply voltage	AC 230 V ~ 50 Hz
Fuse	5 mm × 20 mm, 3.15 A, 250 V, fast-acting
Power consumption	400 W
Dimensions (W × H × D)	280 mm × 150 mm × 190 mm (15.35in. × 5.31in. × 15.55in.)
Weight	2.1 kg

## 9 Plug and connection assignments

### Introduction

This chapter will help you select the right cables and plugs to connect your valuable equipment so that a perfect light experience is guaranteed.

Please take our tips, because especially in 'Sound & Light' caution is indicated: Even if a plug fits into a socket, the result of an incorrect connection may be a destroyed DMX controller, a short circuit or 'just' a not working light show!

### DMX connections



The unit offers a 3-pin XLR socket for DMX output and a 3-pin XLR plug for DMX input. Please refer to the drawing and table below for the pin assignment of a suitable XLR plug.

Pin	Configuration
1	Ground, shielding
2	Signal inverted (DMX-, 'cold signal')
3	Signal (DMX+, 'hot signal')

## 10 Troubleshooting

In the following we list a few common problems that may occur during operation. We give you some suggestions for easy troubleshooting:

Symptom	Remedy
The unit does not work	Check the mains connection and the main fuse.
No haze output	<ol style="list-style-type: none"> <li>1. Check the fluid level in the fog container.</li> <li>2. Switch the device off and check the hose that leads into the fluid container for flow.</li> </ol>
No response to the DMX controller	<ol style="list-style-type: none"> <li>1. Check the address settings and the DMX polarity.</li> <li>2. Try using another DMX controller.</li> <li>3. Check to see if the DMX cables run near or alongside to high voltage cables that may cause damage or interference to DMX interface circuits.</li> </ol>

If the procedures recommended above do not succeed, please contact our Service Center. You can find the contact information at [www.thomann.de](http://www.thomann.de).



## 11 Cleaning



### NOTICE!

#### Possible damages caused by unsuitable cleaning agents

Cleaners not approved by the manufacturer may permanently damage the unit.

Only use the fog machine cleaners listed on [www.thomann.de](http://www.thomann.de) and follow their instructions for use.

Clean the appliance after every 30 operating hours, or if it was not in use for a longer period of time.

### Procedure

1. ➤ Make sure that the device is turned off, disconnected from the mains and completely cooled down.
2. ➤ Place the unit in a well ventilated place.
3. ➤ Take the suction hose out of the fluid container of the fog machine and put it into the bottle with the cleaning fluid.
4. ➤ Connect the device to the mains.
5. ➤ Wait until the required operating temperature is reached.

- 6.** ▶ Keep the remote control button pressed and release fog for about 20 seconds.
- 7.** ▶ Put the suction hose back into the fluid container of the fog machine and release fog for another 20 seconds. This rinses the pipes.
  - ⇒ The cleaning is completed.

## 12 Protecting the environment

### Disposal of the packaging material



For the transport and protective packaging, environmentally friendly materials have been chosen that can be supplied to normal recycling.

Ensure that plastic bags, packaging, etc. are properly disposed of.

Do not just dispose of these materials with your normal household waste, but make sure that they are collected for recycling. Please follow the notes and markings on the packaging.

### Disposal of your old device



This product is subject to the European Waste Electrical and Electronic Equipment Directive (WEEE) in its currently valid version. Do not dispose with your normal household waste.

Dispose of this device through an approved waste disposal firm or through your local waste facility. When discarding the device, comply with the rules and regulations that apply in your country. If in doubt, consult your local waste disposal facility.



AF-40 DMX





