



  
STAIRVILLE

MH-100 Beam  
36x3 LED  
moving head

Musikhaus Thomann  
Thomann GmbH  
Hans-Thomann-Straße 1  
96138 Burgebrach  
Germany  
Telephone: +49 (0) 9546 9223-0  
E-mail: [info@thomann.de](mailto:info@thomann.de)  
Internet: [www.thomann.de](http://www.thomann.de)

13.05.2019, ID: 325876 (V3)

# Table of contents

<b>1</b>	<b>General information</b> .....	<b>5</b>
	1.1 Further information.....	6
	1.2 Notational conventions.....	7
	1.3 Symbols and signal words.....	8
<b>2</b>	<b>Safety instructions</b> .....	<b>10</b>
<b>3</b>	<b>Features</b> .....	<b>18</b>
<b>4</b>	<b>Installation</b> .....	<b>19</b>
<b>5</b>	<b>Starting up</b> .....	<b>23</b>
<b>6</b>	<b>Connections and operating elements</b> .....	<b>26</b>
<b>7</b>	<b>Operating</b> .....	<b>31</b>
	7.1 Starting the device.....	31
	7.2 Main menu.....	32
	7.3 Functions in 9-channel DMX mode.....	39
	7.4 Functions in 14-channel DMX mode.....	40
<b>8</b>	<b>Technical specifications</b> .....	<b>44</b>

<b>9</b>	<b>Plug and connection assignments.....</b>	<b>47</b>
<b>10</b>	<b>Troubleshooting.....</b>	<b>48</b>
<b>11</b>	<b>Cleaning.....</b>	<b>50</b>
<b>12</b>	<b>Protecting the environment.....</b>	<b>51</b>

# 1 General information

This user manual contains important information on the safe operation of the device. Read and follow all safety notes and all instructions. Save this manual for future reference. Make sure that it is available to all persons using this device. If you sell the device to another user, be sure that they also receive this manual.

Our products and user manuals are subject to a process of continuous development. We therefore reserve the right to make changes without notice. Please refer to the latest version of the user manual which is ready for download under [www.thomann.de](http://www.thomann.de).

## 1.1 Further information

On our website ([www.thomann.de](http://www.thomann.de)) you will find lots of further information and details on the following points:

Download	This manual is also available as PDF file for you to download.
Keyword search	Use the search function in the electronic version to find the topics of interest for you quickly.
Online guides	Our online guides provide detailed information on technical basics and terms.
Personal consultation	For personal consultation please contact our technical hotline.
Service	If you have any problems with the device the customer service will gladly assist you.

## 1.2 Notational conventions

This manual uses the following notational conventions:

### Letterings

The letterings for connectors and controls are marked by square brackets and italics.

**Examples:** *[VOLUME]* control, *[Mono]* button.

### Displays

Texts and values displayed on the device are marked by quotation marks and italics.

**Examples:** *'24ch'*, *'OFF'*.

### Cross-references

References to other locations in this manual are identified by an arrow and the specified page number. In the electronic version of the manual, you can click the cross-reference to jump to the specified location.





Example: See ↗ *'Cross-references'* on page 7.

## 1.3 Symbols and signal words

In this section you will find an overview of the meaning of symbols and signal words that are used in this manual.

Signal word	Meaning
<b>DANGER!</b>	This combination of symbol and signal word indicates an immediate dangerous situation that will result in death or serious injury if it is not avoided.
<b>WARNING!</b>	This combination of symbol and signal word indicates a possible dangerous situation that can result in death or serious injury if it is not avoided.
<b>CAUTION!</b>	This combination of symbol and signal word indicates a possible dangerous situation that can result in minor injury if it is not avoided.
<b>NOTICE!</b>	This combination of symbol and signal word indicates a possible dangerous situation that can result in material and environmental damage if it is not avoided.



Warning signs	Type of danger
	Warning – high-voltage.
	Warning – dangerous optical radiation.
	Warning – suspended load.
	Warning – danger zone.

## 2 Safety instructions

### Intended use

This device is intended for use as a freely moving multifunctional spotlight. The device is designed for professional use and is not suitable for use in households. Use the device only as described in this user manual. Any other use or use under other operating conditions is considered to be improper and may result in personal injury or property damage. No liability will be assumed for damages resulting from improper use.

This device may be used only by persons with sufficient physical, sensorial, and intellectual abilities and having corresponding knowledge and experience. Other persons may use this device only if they are supervised or instructed by a person who is responsible for their safety.

Extend the operating life of the device by regular breaks and by avoiding frequent switching on and off. The device is not suitable for continuous operation.

**Safety****DANGER!****Danger for children**

Ensure that plastic bags, packaging, etc. are disposed of properly and are not within reach of babies and young children. Choking hazard!

Ensure that children do not detach any small parts (e.g. knobs or the like) from the unit. They could swallow the pieces and choke!

Never let children unattended use electrical devices.

**DANGER!****Electric shock caused by high voltages inside**

Within the device there are areas where high voltages may be present. Never remove any covers.

There are no user-serviceable parts inside.

Do not use the device if covers, protectors or optical components are missing or damaged.



### **DANGER!**

#### **Electric shock caused by short-circuit**

Always use proper ready-made insulated mains cabling (power cord) with a protective contact plug. Do not modify the mains cable or the plug. Failure to do so could result in electric shock/death or fire. If in doubt, seek advice from a registered electrician.



### **WARNING!**

#### **Eye damage caused by high light intensity**

Never look directly into the light source.



### **WARNING!**

#### **Risk of epileptic shock**

Strobe lighting can trigger seizures in photosensitive epilepsy. Sensitive persons should avoid looking at strobe lights.



**WARNING!**

**Risk of injury caused by falling objects**

Make sure that the installation complies with the standards and rules that apply in your country. Always secure the device with a secondary safety attachment, such as a safety cable or a safety chain.

The load capacity of trusses or other fixtures must be sufficient for the intended number of devices. Note that the movement of the head places additional loads on the load-bearing parts.



### **CAUTION!**

#### **Risk of injury due to movements of the device**

The head of the device can move quickly (pan, tilt) and can produce very bright light. This is also valid immediately after you turn on the device, when the device operates in automatic mode or under remote control and when you turn off a DMX controller that is connected to the device. Persons staying near the device could be injured or frightened.

Before you turn on the device and during the operation, always ensure that nobody stays close to the device. If work has to be performed in the area of movement or in the near vicinity of the device, it must remain turned off.



### **NOTICE!**

#### **Risk of fire**

Do not block areas of ventilation. Do not install the device near any direct heat source. Keep the device away from naked flames.



**NOTICE!**

**Operating conditions**

This device has been designed for indoor use only. To prevent damage, never expose the device to any liquid or moisture. Avoid direct sunlight, heavy dirt, and strong vibrations.

Only operate the device within the ambient conditions specified in the chapter 'Technical specifications' of this user manual. Avoid heavy temperature fluctuations and do not switch the device on immediately after it was exposed to temperature fluctuations (for example after transport at low outside temperatures).

Dust and dirt inside can damage the unit. When operated in harmful ambient conditions (dust, smoke, nicotine, fog, etc.), the unit should be maintained by qualified service personnel at regular intervals to prevent overheating and other malfunction.

The device must not be moved during use.



### **NOTICE!**

#### **Power supply**

Before connecting the device, ensure that the input voltage (AC outlet) matches the voltage rating of the device and that the AC outlet is protected by a residual current circuit breaker. Failure to do so could result in damage to the device and possibly injure the user.

Unplug the device before electrical storms occur and when it is unused for long periods of time to reduce the risk of electric shock or fire.



### **NOTICE!**

#### **Possible staining**

The plasticiser contained in the rubber feet of this product may possibly react with the coating of your parquet, linoleum, laminate or PVC floor and after some time cause permanent dark stains.

In case of doubt, do not put the rubber feet directly on the floor, but use felt-pad floor protectors or a carpet.





**NOTICE!**

**Risk of overheating**

The distance between light output and the illuminated surface must be more than 1.5 m (19.7in).

Provide sufficient ventilation.

The ambient temperature must always be below 40 °C (104 °F).



**NOTICE!**

**Possible damage due to installation of a wrong fuse**

The use of different types of fuses can cause serious damage to the unit. Fire hazard!

Only fuses of the same type may be used.

## 3 Features

The moving head is particularly suitable for professional lighting tasks, for example at events, on rock stages, in theatres and musicals or in night clubs.

Special features of the device:

- 36 × 3 W LEDs (8 × red, 10 × green, 10 × blue, 8 × white)
- Control via DMX (9 or 14 channels) as well as buttons and display on the unit
- Preprogrammed automatic show programmes
- Sound control
- Master / slave mode
- Strobe effect
- Electronic dimmer
- Robust housing with two integrated carrying handles
- Omega Bracket with quick locks included

For technological reasons, the light output of LEDs decreases over their lifetime. This effect increases with higher operating temperature. You can extend the service life of the illuminants by providing adequate ventilation and operating the LEDs with the lowest possible brightness.

## 4 Installation

Unpack and check carefully there is no transportation damage before using the unit. Keep the equipment packaging. To fully protect the product against vibration, dust and moisture during transportation or storage use the original packaging or your own packaging material suitable for transport or storage, respectively.

Lift the device only at the base. When lifted at the rotatable mounting, the device may be damaged.

You can install the device standing or hanging. When in use, the device must be mounted at a solid surface or clamped to an approved truss.

Work from a stable platform whenever you install or move the device or when you perform any kind of maintenance. Block access under the work area.



## **WARNING!**

### **Risk of injury caused by falling objects**

Make sure that the installation complies with the standards and rules that apply in your country. Always secure the device with a secondary safety attachment, such as a safety cable or a safety chain.

The load capacity of trusses or other fixtures must be sufficient for the intended number of devices. Note that the movement of the head places additional loads on the load-bearing parts.



## **NOTICE!**

### **Risk of overheating**

The distance between light output and the illuminated surface must be more than 1.5 m (19.7in).

Provide sufficient ventilation.

The ambient temperature must always be below 40 °C (104 °F).



**NOTICE!**

**Possible data transmission errors**

For error-free operation make use of dedicated DMX cables and do not use ordinary microphone cables.

Never connect the DMX input or output to audio devices such as mixers or amplifiers.

## Mounting options

The quick lock openings on the housing bottom are used for secure attachment of Omega brackets. To these, the flight adapters (half coupler, trigger clamps, C-hooks, etc.) are attached. The safety cable must be routed through the safety eyelet on the rear side ( ↪ Chapter 6 'Connections and operating elements' on page 26).

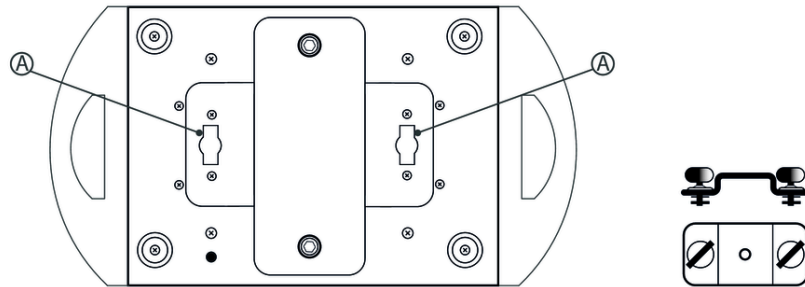

A Quick lock openings for Omega brackets

## 5 Starting up

Create all connections while the device is off. Use the shortest possible high-quality cables for all connections. Take care when running the cables to prevent tripping hazards.

### Connections in DMX mode

Connect the DMX input of the device to the DMX output of a DMX controller or another DMX device. Connect the output of the first DMX device to the input of the second one, and so on to form a daisy chain. Always ensure that the output of the last DMX device in the daisy chain is terminated with a resistor ( $110\ \Omega$ ,  $\frac{1}{4}\text{ W}$ ).

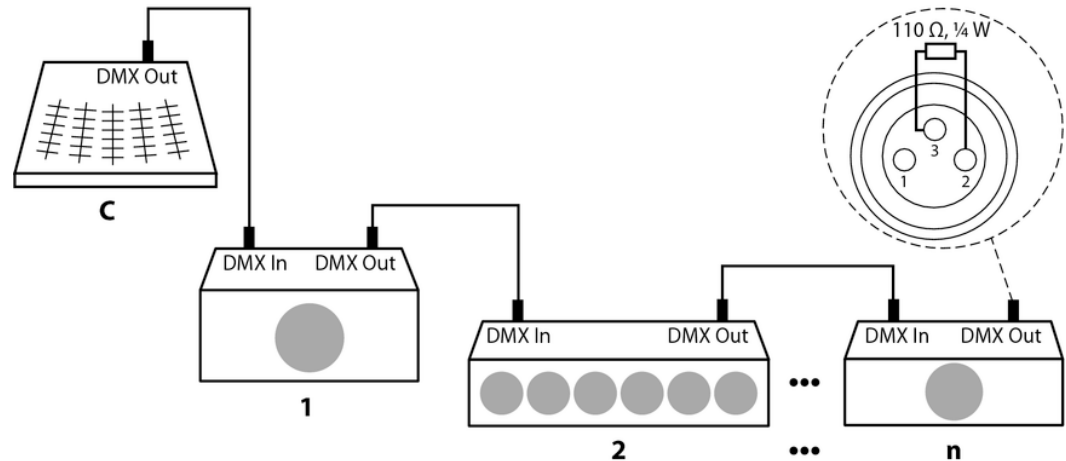

The flashing 'DMX' LED indicates an incoming DMX signal.



**Connections in master/slave mode**

When you configure a group of devices in master/slave mode, the first unit will control the other units for an automatic, sound-activated, synchronized show. This function is ideal when you want to start a show immediately. Connect the DMX output of the master device to the DMX input of the first slave device. Then connect the DMX output of the first slave device to the DMX input of the second slave device and so on.

## 6 Connections and operating elements

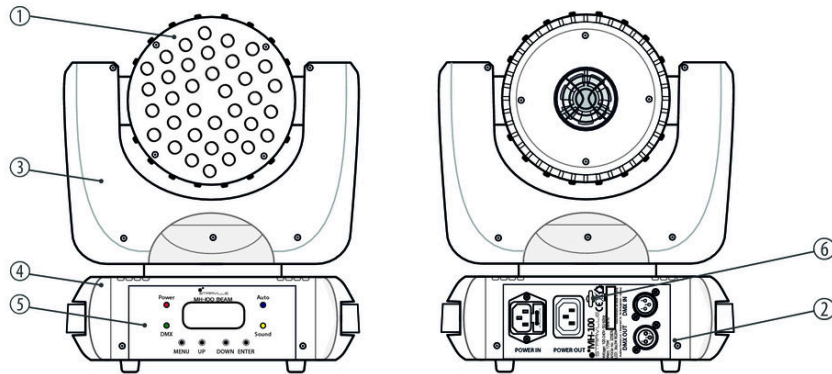

1 Spotlight head with LEDs.

2 Connections.

3	Rotatable mounting.
4	Device base.
5	Operating elements.
6	Safety eye.

## Operating elements

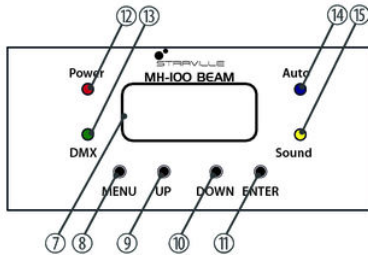

7 Display.

When the main menu is activated, the display shows the current menu item and the set option. When the main menu is closed, it shows the current operating mode. The display is dimmed a few seconds after the last keystroke.

8 *[MENU]*

Activates the main menu and toggles between menu items. Closes an open sub-menu without saving any changes.

9 *[DOWN]*

Decreases the displayed value by one.

10 *[UP]*

Increases the displayed value by one.

11 *[ENTER]*

Selects an option of the respective operating mode.

12 *[Power]*

The LED indicates that the device is connected to the power grid.

13	<i>[DMX]</i> The LED flashes when a DMX signal is received.
14	<i>[Auto]</i> The LED indicates that the automatic show is running.
15	<i>[Sound]</i> The LED lights up when the music controlled automatic show is running. The briefly flashing LED indicates an incoming signal from the microphone during the music controlled automatic show.

## Connections

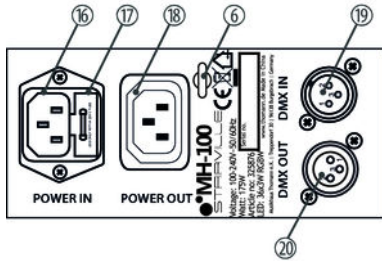

6 Safety eye.

16 [POWER IN]  
IEC chassis plug for the power supply.

17 Fuse holder.  
If the fuse blows, replace it with a new fuse of the same type. You must first disconnect the device from the power supply.

18 [POWER OUT]  
IEC chassis socket for the power supply cable to the next unit.

19 [DMX IN]  
DMX input.

20 [DMX OUT]  
DMX output.

## 7 Operating

### 7.1 Starting the device



#### **CAUTION!**

##### **Risk of injury due to movements of the device**

The head of the device can move quickly (pan, tilt) and can produce very bright light. This is also valid immediately after you turn on the device, when the device operates in automatic mode or under remote control and when you turn off a DMX controller that is connected to the device. Persons staying near the device could be injured or frightened.

Before you turn on the device and during the operation, always ensure that nobody stays close to the device. If work has to be performed in the area of movement or in the near vicinity of the device, it must remain turned off.

Connect the device to the power supply to start operation. After a few seconds, the fans start to work, the head moves to the home positions for rotation (pan) and inclination (tilt), the screen displays a start message. After a few more seconds, the device operates in the last set mode.

## 7.2 Main menu

Press [MENU] to activate the main menu. Use the buttons [UP] or [DOWN] to select a submenu. When the display shows the desired submenu, press [ENTER] to open it. To close the main menu, press [MENU] or wait for 5 seconds.



*As soon as you activate the main menu, the DMX control and a currently running automatic show are being interrupted. The movable head of the unit moves to its home position.*

*If you close the main menu without making changes, the unit continues to operate with the previous settings.*

All previous settings are retained even when you disconnect the device from the mains. To restart with default values, use the function 'System Reset' (↩ 'Default settings' on page 37).



**DMX address**

Press *[MENU]*, then *[UP]* or *[DOWN]* until the display shows 'DMX Address'. Press *[ENTER]*. The display starts to flash. Now you can set the number of the first DMX channel to be used by the device (DMX address). Use the buttons *[UP]* or *[DOWN]* to select a value between 1 and 512.

When the display shows the desired value, press *[ENTER]* to save the settings and close the submenu. To close the submenu and the main menu without making changes, press *[MENU]* or wait for 5 seconds.

Make sure that the DMX address matches the configuration of your DMX controller. The following table shows the highest possible DMX address for the various DMX modes

<b>Mode</b>	<b>Highest possible DMX address</b>
9-channel	504
14-channel	499

### Operating mode 'DMX'

Press *[MENU]*, then *[UP]* or *[DOWN]* until the display shows 'Control Mode'. Press *[ENTER]*. The display starts to flash. With the buttons *[UP]* or *[DOWN]* you can now choose from the following DMX operating modes: 9-channel or 14-channel. This setting is only relevant if the device is controlled via DMX.

When the display shows the desired value, press *[ENTER]* to save the settings and close the submenu. To close the submenu and the main menu without making changes, press *[MENU]* or wait for 5 seconds.

### Operating mode 'Master' or 'Slave'

Press *[MENU]*, then *[UP]* or *[DOWN]* until the display shows 'Slave Mode'. Press *[ENTER]*. The display starts to flash. With the buttons *[UP]* or *[DOWN]* you can now select an operating mode:

- 'Slave': The device is controlled by another device, which is configured as master.
- 'Master': The Master device sets the movements and light effects which are copied by the devices configured as Slaves.

When the display shows the desired value, press *[ENTER]* to save the settings and close the submenu. To close the submenu and the main menu without making changes, press *[MENU]* or wait for 5 seconds.

This setting is only relevant if the device is not controlled via DMX.

**Automatic show**

Press *[MENU]*, then *[UP]* or *[DOWN]* until the display shows 'Auto Sound'. Press *[ENTER]*. The display starts to flash. With the buttons *[UP]* or *[DOWN]* you can now select between 'Auto' (automatic show) and 'Sound' (sound controlled automatic show).

Automatic operation can only be activated when the unit is operating in stand alone mode or as master in a master / slave combination. This setting is only relevant if the device is not controlled via DMX.

Press *[ENTER]* to save the settings and close the submenu. To close the submenu and the main menu without making changes, press *[MENU]* or wait for 5 seconds.

**Pan inversion**

Press *[MENU]*, then *[UP]* or *[DOWN]* until the display shows 'Pan Inverse'. Press *[ENTER]*. The display starts to flash. With the buttons *[UP]* or *[DOWN]* you can now select between 'No' (normal rotation direction) and 'Yes' (inverted rotation direction).

Press *[ENTER]* to save the settings and close the submenu. To close the submenu and the main menu without making changes, press *[MENU]* or wait for 5 seconds.

### **Tilt inversion**

Press *[MENU]*, then *[UP]* or *[DOWN]* until the display shows *'Tilt Inverse'*. Press *[ENTER]*. The display starts to flash. With the buttons *[UP]* or *[DOWN]* you can now select between *'No'* (normal inclination direction) and *'Yes'* (inverted inclination direction).

When the display shows the desired value, press *[ENTER]* to save the settings and close the submenu. To close the submenu and the main menu without making changes, press *[MENU]* or wait for 5 seconds.

### **Dimmer speed**

With this function you can set how the electronic dimmer operates on changing light conditions.

Press *[MENU]*, then *[UP]* or *[DOWN]* until the display shows *'Dimmer Speed'*. Press *[ENTER]*. The display starts to flash. With the buttons *[UP]* or *[DOWN]* you can now select between *'Fast'* (fast lighting change) and *'Smooth'* (slow lighting changes).

When the display shows the desired value, press *[ENTER]* to save the settings and close the submenu. To close the submenu and the main menu without making changes, press *[MENU]* or wait for 5 seconds.

### **Operating hours display**

Press *[MENU]*, then *[UP]* or *[DOWN]* until the display shows *'Power On Hours'*. Press *[ENTER]*. The display shows how long the device has been already in operation.

To close the operating hours display, press *[ENTER]* or wait for 5 seconds.

**Temperature display**

Press *[MENU]*, then *[UP]* or *[DOWN]* until the display shows 'Fixture Temp'. Press *[ENTER]*. The display alternately shows the temperature of the LEDs ('LED Temp') and the temperature of the electronics inside the unit ('Main PCB').

To close the temperature display, press *[ENTER]* or wait for 5 seconds.

**Selftest**

Press *[MENU]*, then *[UP]* or *[DOWN]* until the display shows 'Auto Test'. Press *[ENTER]*. The device now performs a selftest.

To close the selftest, press *[ENTER]* or wait for 5 seconds.

**Software version**

Press *[MENU]*, then *[UP]* or *[DOWN]* until the display shows 'Firmware Version'. Press *[ENTER]*. The software version of the device will now appear on the display.

To close the software version display, press *[ENTER]* or wait for 5 seconds.

**Default settings**

With this function, you can reset the device to factory default settings.

Press *[MENU]*, then *[UP]* or *[DOWN]* until the display shows 'System Reset'. Press *[ENTER]*. The device now performs a reset.

## Overview

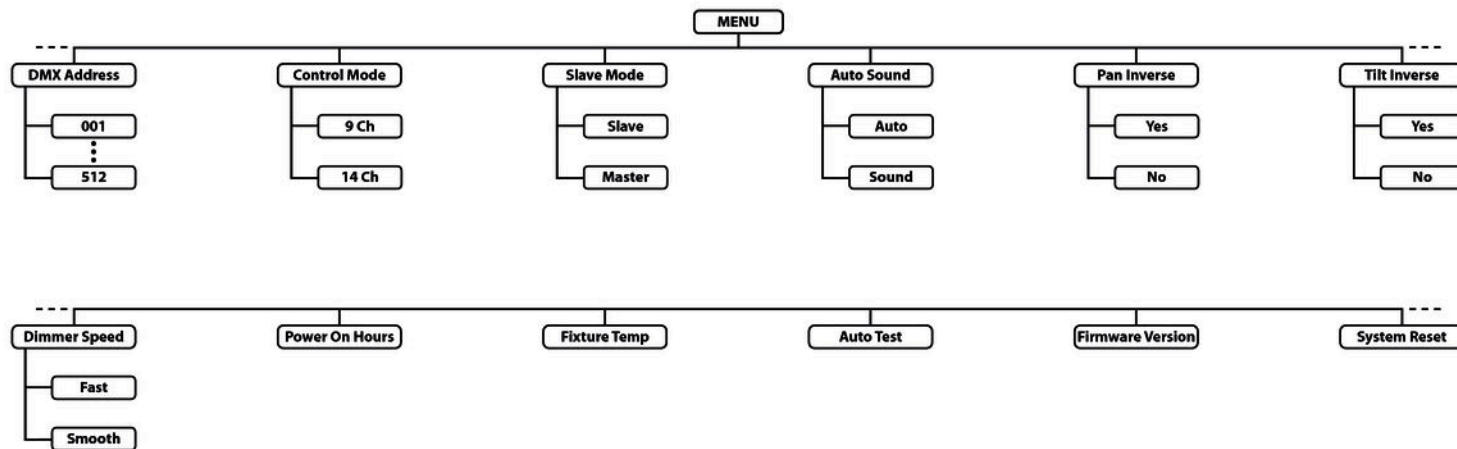

### 7.3 Functions in 9-channel DMX mode

Channel	Value	Function
1	0...255	Rotation (pan) (0° to 630°)
2	0...255	Inclination (tilt) (0° to 220°)
3	0...255	Speed of rotation (pan) and inclination (tilt), fast to slow
4	0...255	Dimmer (0 % to 100 %)
5	0...255	Intensity Red (0 % to 100 %)
6	0...255	Intensity Green (0 % to 100 %)
7	0...255	Intensity Blue (0 % to 100 %)
8	0...255	Intensity White (0 % to 100 %)
9	Strobe effect	
	0...9	Strobe effect off

Channel	Value	Function
	10...140	Strobe effect, increasing speed
	141...255	Strobe effect, random speed

## 7.4 Functions in 14-channel DMX mode

Channel	Value	Function
1	0...255	Rotation (pan) (0° to 630°)
2	0...255	Fine adjustment for rotation (pan)
3	0...255	Inclination (tilt) (0° to 220°)
4	0...255	Fine adjustment for inclination (tilt)
5	0...255	Speed of rotation (pan) and inclination (tilt), fast to slow
6	0...255	Dimmer (0 % to 100 %)



Channel	Value	Function
7	0...255	Intensity Red (0 % to 100 %)
8	0...255	Intensity Green (0 % to 100 %)
9	0...255	Intensity Blue (0 % to 100 %)
10	0...255	Intensity White (0 % to 100 %)
11	White with full intensity and adjustable colour temperature	
	0...35	Blackout, all LEDs off
	36...55	Colour temperature 3200 K
	56...75	Colour temperature 3400 K
	76...95	Colour temperature 4200 K
	96...115	Colour temperature 4900 K
	116..135	Colour temperature 5600 K
	136...175	Colour temperature 6500 K
	176...195	Colour temperature 7200 K

Channel	Value	Function
	196...215	Colour temperature 8000 K
	216...235	Colour temperature 8500 K
	236...255	Colour temperature 10000 K
12	Constant colour	
	0...14	Blackout, all LEDs off
	15...255	One of 28 preprogrammed colours
13	Strobe effect	
	0...9	Strobe effect off
	10...140	Strobe effect, increasing speed
	141...255	Strobe effect, random speed
14	Special functions	
	0...99	Without function

---

Channel	Value	Function
	100...199	Automatic sound controlled show
	200...255	Reset, if the value is transmitted for at least five seconds

## 8 Technical specifications

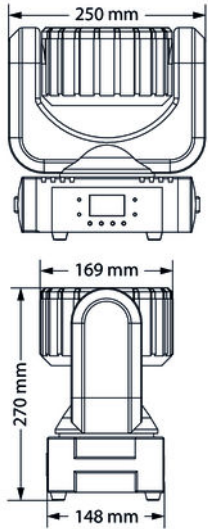

Light source		36 × 3 W LEDs (8 × red, 10 × green, 10 × blue, 8 × white)
Optical properties	Beam angle	8°
	Maximum rotation angle (pan)	630°
	Maximum inclination angle (tilt)	220°
Dimmer		electronic, 0 ... 100 %
Control		DMX Buttons and display on the unit
Number of DMX channels		9 or 14
Input connections	Power supply	IEC chassis connector
	DMX control	XLR chassis socket, 3-pin

Output connections	Power supply	IEC chassis plug
	DMX control	XLR chassis socket, 3-pin
Power consumption		150 W
Supply voltage		AC 230 V ~ 50 Hz
Fuse		5 mm × 20 mm, 3.0 A, 250 V, fast-acting
Degree of protection		IP20
Mounting options		Hanging, standing
Dimensions (W × H × D)		250 mm × 270 mm × 169 mm
Weight		4.9 kg
Ambient conditions	Temperature range	0 °C...40 °C
	Relative humidity	50 %, non-condensing

### Further information

Light output	108 W
Colour mixture	RGBW
Gobo wheel	No
Prism	No
Motorized focus	No
Motorized zoom	No

# 9 Plug and connection assignments

## Introduction

This chapter will help you select the right cables and plugs to connect your valuable equipment so that a perfect light experience is guaranteed.

Please take our tips, because especially in 'Sound & Light' caution is indicated: Even if a plug fits into a socket, the result of an incorrect connection may be a destroyed DMX controller, a short circuit or 'just' a not working light show!

## DMX connections



The unit offers a 3-pin XLR socket for DMX output and a 3-pin XLR plug for DMX input. Please refer to the drawing and table below for the pin assignment of a suitable XLR plug.

Pin	Configuration
1	Ground, shielding
2	Signal inverted (DMX-, 'cold signal')
3	Signal (DMX+, 'hot signal')

## 10 Troubleshooting



### **NOTICE!**

#### **Possible data transmission errors**

For error-free operation make use of dedicated DMX cables and do not use ordinary microphone cables.

Never connect the DMX input or output to audio devices such as mixers or amplifiers.

In the following we list a few common problems that may occur during operation. We give you some suggestions for easy troubleshooting:



Symptom	Remedy
The unit does not work, no light, the fan does not run	Check the mains power connection and the main fuse.
No response to DMX controller	<ol style="list-style-type: none"> <li>1. The LED 'DMX' should be flashing on data transmission. If it doesn't, check the DMX connectors and cables for proper connection.</li> <li>2. If the LED 'DMX' lights up without response, check the address settings and DMX polarity.</li> <li>3. Try using another DMX controller.</li> <li>4. Check to see if the DMX cables run near or alongside to high voltage cables that may cause damage or interference to DMX interface circuits.</li> </ol>

If the procedures recommended above do not succeed, please contact our Service Center. You can find the contact information at [www.thomann.de](http://www.thomann.de).

## 11 Cleaning

### Optical lenses

Clean the optical lenses, that are accessible from the outside, regularly in order to optimize the light output. The frequency of cleaning depends on the operating environment: wet, smoky or particularly dirty surroundings can cause more accumulation of dirt on the optics of the device.

- Clean with a soft cloth using our lamp and lens cleaner (item no. 280122).
- Always dry the parts carefully.

### Fan grids

The fan grids of the device must be cleaned of any contamination, such as dust, etc. on a regular basis. Before cleaning, switch off the device and disconnect mains-operated devices from the mains. Only use pH-neutral, solvent-free and non-abrasive cleaning agents. Clean the unit with a slightly damp lint-free cloth.

## 12 Protecting the environment

### Disposal of the packaging material



For the transport and protective packaging, environmentally friendly materials have been chosen that can be supplied to normal recycling.

Ensure that plastic bags, packaging, etc. are properly disposed of.

Do not just dispose of these materials with your normal household waste, but make sure that they are collected for recycling. Please follow the notes and markings on the packaging.

### Disposal of your old device



This product is subject to the European Waste Electrical and Electronic Equipment Directive (WEEE) in its currently valid version. Do not dispose with your normal household waste.

Dispose of this device through an approved waste disposal firm or through your local waste facility. When discarding the device, comply with the rules and regulations that apply in your country. If in doubt, consult your local waste disposal facility.



MH-100 Beam 36x3 LED





