

NOTE Default setting of the system frame rate is 59.94 Hz. When you want to operate in the Frame Rate of 50 Hz, you can set it at the System screen.

VR-50HD

MULTI-FORMAT AV MIXER

Owner's Manual

Roland

Use the latest version of the system program for the VR-50HD.

Owner's Manual (this document)

Read this first. It explains the basic things you need to know in order to use the VR-50HD.

PDF Manual (download from the Web)

• Reference Manual

This explains all parameters of the VR-50HD. It also describes the settings to make when operating the unit by remote control.

 To obtain the PDF manual
The latest information on the system program

1. Enter the following URL in your computer.

<http://www.rolandsystemsgroup.net/>



2. Choose "VR-50HD" as the product name.

USING THE UNIT SAFELY

Before using this unit, carefully read the sections entitled "USING THE UNIT SAFELY" and "IMPORTANT NOTES" (p. 4). These sections provide important information concerning the proper operation of the unit. Additionally, in order to feel assured that you have gained a good grasp of every feature of your new unit, read Owner's manual in its entirety. This manual should be saved and kept on hand as a convenient reference.

INSTRUCTIONS FOR THE PREVENTION OF FIRE, ELECTRIC SHOCK, OR INJURY TO PERSONS

About ⚠ WARNING and ⚠ CAUTION Notices

⚠ WARNING	Used for instructions intended to alert the user to the risk of death or severe injury should the unit be used improperly.
⚠ CAUTION	Used for instructions intended to alert the user to the risk of injury or material damage should the unit be used improperly. * Material damage refers to damage or other adverse effects caused with respect to the home and all its furnishings, as well to domestic animals or pets.

About the Symbols

	The ⚠ symbol alerts the user to important instructions or warnings. The specific meaning of the symbol is determined by the design contained within the triangle. In the case of the symbol at left, it is used for general cautions, warnings, or alerts to danger.
	The ⚡ symbol alerts the user to items that must never be carried out (are forbidden). The specific thing that must not be done is indicated by the design contained within the circle. In the case of the symbol at left, it means that the unit must never be disassembled.
	The ⚠ symbol alerts the user to things that must be carried out. The specific thing that must be done is indicated by the design contained within the circle. In the case of the symbol at left, it means that the power-cord plug must be unplugged from the outlet.

ALWAYS OBSERVE THE FOLLOWING

⚠ WARNING

To completely turn off power to the unit, pull out the plug from the outlet

Even with the power switch turned off, this unit is not completely separated from its main source of power. When the power needs to be completely turned off, turn off the power switch on the unit, then pull out the plug from the outlet. For this reason, the outlet into which you choose to connect the power cord's plug should be one that is within easy reach and readily accessible.



Never obstruct the ventilation holes

Doing so might impede safe operation.

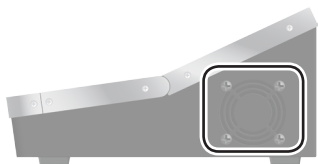
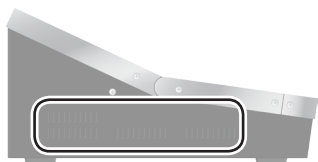

Do not disassemble or modify by yourself

Do not open (or modify in any way) the unit or its AC adaptor.



⚠ WARNING

Do not repair or replace parts by yourself

Do not attempt to repair the unit, or replace parts within it (except when this manual provides specific instructions directing you to do so). Refer all servicing to your retailer, the nearest Roland Service Center, or an authorized Roland distributor, as listed on the "Information" sheet.



Do not use or store in the following types of locations

- Subject to temperature extremes (e.g., direct sunlight in an enclosed vehicle, near a heating duct, on top of heat-generating equipment); or are
- Damp (e.g., baths, washrooms, on wet floors); or are
- Exposed to steam or smoke; or are
- Subject to salt exposure; or are
- Humid; or are
- Exposed to rain; or are
- Dusty or sandy; or are
- Subject to high levels of vibration and shakiness.



Do not place in an unstable location

Make sure you always have the unit placed so it is level and sure to remain stable. Never place it on stands that could wobble, or on inclined surfaces.



⚠ WARNING

Use only the supplied AC adaptor and the correct voltage

Be sure to use only the AC adaptor supplied with the unit. Also, make sure the line voltage at the installation matches the input voltage specified on the AC adaptor's body. Other AC adaptors may use a different polarity, or be designed for a different voltage, so their use could result in damage, malfunction, or electric shock.



Use only the supplied power cord

Use only the attached power-supply cord. Also, the supplied power cord must not be used with any other device.



Do not bend the power cord or place heavy objects on it

Do not excessively twist or bend the power cord, nor place heavy objects on it. Doing so can damage the cord, producing severed elements and short circuits. Damaged cords are fire and shock hazards!



Avoid extended use at high volume

This unit, either alone or in combination with an amplifier and headphones or speakers, may be capable of producing sound levels that could cause permanent hearing loss. Do not operate for a long period of time at a high volume level, or at a level that is uncomfortable. If you experience any hearing loss or ringing in the ears, you should immediately stop using the unit, and consult an audiologist.



⚠ WARNING

Don't allow foreign objects or liquids to enter unit; never place containers with liquid on unit

Do not place containers containing liquid (e.g., flower vases) on this product. Never allow foreign objects (e.g., flammable objects, coins, wires) or liquids (e.g., water or juice) to enter this product. Doing so may cause short circuits, faulty operation, or other malfunctions.



Turn off the unit if an abnormality or malfunction occurs

Immediately turn the unit off, remove the AC adaptor from the outlet, and request servicing by your retailer, the nearest Roland Service Center, or an authorized Roland distributor, as listed on the "Information" sheet when:



- The AC adaptor, the power-supply cord, or the plug has been damaged; or
- If smoke or unusual odor occurs; or
- Objects have fallen into, or liquid has been spilled onto the unit; or
- The unit has been exposed to rain (or otherwise has become wet); or
- The unit does not appear to operate normally or exhibits a marked change in performance.

Adults must provide supervision in places where children are present

Always make sure that an adult is on hand to provide supervision and guidance when using the unit in places where children are present.



Do not drop or subject to strong impact

Protect the unit from strong impact. (Do not drop it!)



Do not share an outlet with an unreasonable number of other devices

Do not force the unit's power-supply cord to share an outlet with an unreasonable number of other devices.



Be especially careful when using extension cords—the total power used by all devices you have connected to the extension cord's outlet must never exceed the power rating (watts/amperes) for the extension cord. Excessive loads can cause the insulation on the cord to heat up and eventually melt through.

Do not use overseas

Before using the unit in overseas, consult with your retailer, the nearest Roland Service Center, or an authorized Roland distributor, as listed on the "Information" sheet.



⚠ CAUTION

Place in a well ventilated location

The unit and the AC adaptor should be located so their location or position does not interfere with their proper ventilation.



When disconnecting an AC adaptor, grasp it by the plug

To prevent conductor damage, always grasp the AC adaptor by its plug when disconnecting it from this unit or from a power outlet.



Periodically clean the AC adaptor's plug

At regular intervals, you should unplug the AC adaptor and clean it by using a dry cloth to wipe all dust and other accumulations away from its prongs. Also, disconnect the power plug from the power outlet whenever the unit is to remain unused for an extended period of time. Any accumulation of dust between the power plug and the power outlet can result in poor insulation and lead to fire.



Manage cables for safety

Try to prevent cords and cables from becoming entangled. Also, all cords and cables should be placed so they are out of the reach of children.



Avoid climbing on top of the unit, or placing heavy objects on it

Never climb on top of, nor place heavy objects on the unit.



Do not connect or disconnect the AC adaptor with wet hands

Never handle the AC adaptor or its plugs with wet hands when plugging into, or unplugging from, an outlet or this unit.



Disconnect everything before moving the unit

Before moving the unit, disconnect the AC adaptor and all cords coming from external devices.



Unplug the AC adaptor from the outlet before cleaning

Before cleaning the unit, turn it off and unplug the AC adaptor from the outlet (p. 12).



If there is a possibility of lightning strike, disconnect the AC adaptor from the outlet

Whenever you suspect the possibility of lightning in your area, disconnect the AC adaptor from the outlet.



⚠ CAUTION

Keep small items out of the reach of children

To prevent accidental ingestion of the parts listed below, always keep them out of the reach of small children.



- Included Parts
RCA-BNC conversion plug (p. 15)

Handle the ground terminal carefully

If you remove the screw from the ground terminal, be sure to replace it; don't leave it lying around where it could accidentally be swallowed by small children. When refastening the screw, make that it is firmly fastened, so it won't come loose.



Take care not to get burned

The area of SDI connectors on the rear panel may become hot, so take care to avoid burns.



Precautions concerning use of phantom power supply

Always turn the phantom power off when connecting any device other than condenser microphones that require phantom power. You risk causing damage if you mistakenly supply phantom power to dynamic microphones, audio playback devices, or other devices that don't require such power. Be sure to check the specifications of any microphone you intend to use by referring to the manual that came with it.



- This instrument's phantom power:
+48 V DC, 5 mA Max

IMPORTANT NOTES

Power Supply

- Do not connect this unit to same electrical outlet that is being used by an electrical appliance that is controlled by an inverter or a motor (such as a refrigerator, washing machine, microwave oven, or air conditioner). Depending on the way in which the electrical appliance is used, power supply noise may cause this unit to malfunction or may produce audible noise. If it is not practical to use a separate electrical outlet, connect a power supply noise filter between this unit and the electrical outlet.
- The AC adaptor will begin to generate heat after long hours of consecutive use. This is normal, and is not a cause for concern.
- To prevent malfunction and equipment failure, always make sure to turn off the power on all your equipment before you make any connections.

Placement

- Using the unit near power amplifiers (or other equipment containing large power transformers) may induce hum. To alleviate the problem, change the orientation of this unit; or move it farther away from the source of interference.
- This device may interfere with radio and television reception. Do not use this device in the vicinity of such receivers.
- Noise may be produced if wireless communications devices, such as cell phones, are operated in the vicinity of this unit. Such noise could occur when receiving or initiating a call, or while conversing. Should you experience such problems, you should relocate such wireless devices so they are at a greater distance from this unit, or switch them off.
- Do not expose the unit to direct sunlight, place it near devices that radiate heat, leave it inside an enclosed vehicle, or otherwise subject it to temperature extremes. Excessive heat can deform or discolor the unit.
- When moved from one location to another where the temperature and/or humidity is very different, water droplets (condensation) may form inside the unit. Damage or malfunction may result if you attempt to use the unit in this condition. Therefore, before using the unit, you must allow it to stand for several hours, until the condensation has completely evaporated.
- Depending on the material and temperature of the surface on which you place the unit, its rubber feet may discolor or mar the surface. You can place a piece of felt or cloth under the rubber feet to prevent this from happening. If you do so, please make sure that the unit will not slip or move accidentally.
- Do not place containers or anything else containing liquid on top of this unit. Also, whenever any liquid has been spilled on the surface of this unit, be sure to promptly wipe it away using a soft, dry cloth.

Maintenance

- For everyday cleaning wipe the unit with a soft, dry cloth or one that has been slightly dampened with water. To remove stubborn dirt, use a cloth impregnated with a mild, non-abrasive detergent. Afterwards, be sure to wipe the unit thoroughly with a soft, dry cloth.
- Never use benzene, thinners, alcohol or solvents of any kind, to avoid the possibility of discoloration and/or deformation.

Repairs and Data

- Before sending the unit away for repairs, be sure to make a backup of the data stored within it; or you may prefer to write down the needed information. Although we will do our utmost to preserve the data stored in your unit when we carry out repairs, in some cases, such as when the memory section is physically damaged, restoration of the stored content may be impossible. Roland assumes no liability concerning the restoration of any stored content that has been lost.

Additional Precautions

- Any data stored within the unit can be lost as the result of equipment failure, incorrect operation, etc. To protect yourself against the irretrievable loss of data, try to make a habit of creating regular backups of the data you've stored in the unit.
- Roland assumes no liability concerning the restoration of any stored content that has been lost.
- Use a reasonable amount of care when using the unit's buttons, sliders, or other controls; and when using its jacks and connectors. Rough handling can lead to malfunctions.
- Never strike or apply strong pressure to the display.
- When disconnecting all cables, grasp the connector itself—never pull on the cable. This way you will avoid causing shorts, or damage to the cable's internal elements.
- To avoid disturbing others nearby, try to keep the unit's volume at reasonable levels.
- When you need to transport the unit, package it in the box (including padding) that it came in, if possible. Otherwise, you will need to use equivalent packaging materials.
- Some connection cables contain resistors. Do not use cables that incorporate resistors for connecting to this unit. The use of such cables can cause the sound level to be extremely low, or impossible to hear. For information on cable specifications, contact the manufacturer of the cable.
- This unit allows you to switch images at high speed. For some people, viewing such images can cause headache, nausea, or other discomfort. Do not use this unit to create video that might cause these types of health problems. Roland Corporation will accept no responsibility for any such health problems that may occur in yourself or in viewers.

Using External Memories

- Please observe the following precautions when handling USB flash drive. Also, make sure to carefully observe all the precautions that were supplied with the external memory device.
 - Do not remove the device while reading/writing is in progress.
 - To prevent damage from static electricity, discharge all static electricity from your person before handling the device.

Copyrights/Licenses/Trademarks

- It is forbidden by law to make an audio recording, video recording, copy or revision of a third party's copyrighted work (musical work, video work, broadcast, live performance, or other work), whether in whole or in part, and distribute, sell, lease, perform, or broadcast it without the permission of the copyright owner.
- Do not use this product for purposes that could infringe on a copyright held by a third party. We assume no responsibility whatsoever with regard to any infringements of third-party copyrights arising through your use of this product.
- MMP (Moore Microprocessor Portfolio) refers to a patent portfolio concerned with microprocessor architecture, which was developed by Technology Properties Limited (TPL). Roland has licensed this technology from the TPL Group.
- Roland, V-Mixer are either registered trademarks or trademarks of Roland Corporation in the United States and/or other countries.
- Microsoft and Windows are either registered trademarks or trademarks of Microsoft Corporation.
- Windows is known officially as: "Microsoft Windows operating system."
- Apple, Macintosh, Mac OS, the Mac logo are either registered trademarks or trademarks of Apple Inc.
- Company names and product names appearing in this document are registered trademarks or trademarks of their respective owners.

Contents

USING THE UNIT SAFELY	2	Inputting HDCP Signals	23
IMPORTANT NOTES	4	Video Operations	24
Panel Descriptions	6	Switching the Video	24
Top Panel/Front Panel	6	Switching by Touching the Screen	24
Video Mixer Section	7	Switching the Video Using Buttons	25
Audio Mixer Section	7	Applying a Fade to Final Video Output	25
Rear Panel	8	Compositing Video	26
Monitor Display	9	Basic Operation	26
Signal Flow	11	Compositing Using Picture-in-Picture (PinP)	27
Preparations for Power-Up	12	Compositing Using a Key (PinP/KEY)	27
Connecting the AC Adaptor	12	Compositing a Still Image (STILL KEY)	28
Using an External Power Source	12	Audio Operations	29
Turning the Power On and Off	12	Channel Parameter Screen	29
Menu Operations	13	Adjusting the Audio Balance	31
Connecting External Equipment	14	Adjusting the Final Audio Output	31
Connecting Video Source Equipment	15	Aligning the Timing of Video and Audio (Lip-sync)	32
Making HDMI Connections	15	Linking Audio to Video Switching (Audio Follow)	32
Making SDI Connections	15	Applying Effects to Audio	33
Making RGB/Component Connections	15	Other Functions	34
Making Composite Connections	15	Formatting USB Flash Drives	34
Assigning Video Sources to Channels	16	Using Still-image Files	35
Connecting Audio Source Equipment	17	Outputting a User Logo	36
Connecting Microphones	17	Freezing the Output Screen	36
Connecting an External Audio Mixer	17	Changing the Screen Labels	37
Connecting Playback Equipment	17	Changing the Video Output Bus	37
Using Phantom Power	18	Assigning an Output Bus to Video Connectors	37
Assigning HDMI/SDI Audio to Channels	18	Selecting the Signal of the AUX Bus	38
Connecting Output Equipment	19	Capturing Video Being Output	38
Connecting Video Output Equipment	19	Saving/Recalling Settings	39
Connecting Audio Output Equipment	19	Saving Settings on a USB Flash Drive/Importing Settings from a USB Flash Drive	40
Connecting a Computer for Streaming	20	Returning to the Factory-default Settings (Factory Reset)	41
Making the Connection to a Computer	20	Appendix	42
Outputting Streamed Video and Audio to a Computer	21	Troubleshooting	42
Making the Settings for Streaming	21	About Remote Control	43
Reconnecting with the Computer	21	Main Specifications	44
Input Formats/Output Formats	22	Index	46
Formats Inputtable Via the Different Connectors	22		
Setting the Output Format	22		

Conventions in this manual

In order to explain the operations as clearly as possible, this manual uses the following conventions.

- Text enclosed in square brackets [] indicates the name of a button or a knob, such as the [SETUP] button, [VALUE] knob.
- Text enclosed in angle brackets < > indicates text that appears in the screen, such as <Output>.
- When the manual instructs you to “touch” something, it means that you should touch that location in the touch panel screen.

* The explanations in this manual include illustrations that depict what should typically be shown by the display. Note, however, that your unit may incorporate a newer, enhanced version of the system (e.g., includes newer sounds), so what you actually see in the display may not always match what appears in the manual.

Copyright © 2013 ROLAND CORPORATION

All rights reserved. No part of this publication may be reproduced in any form without the written permission of ROLAND CORPORATION.

Panel Descriptions

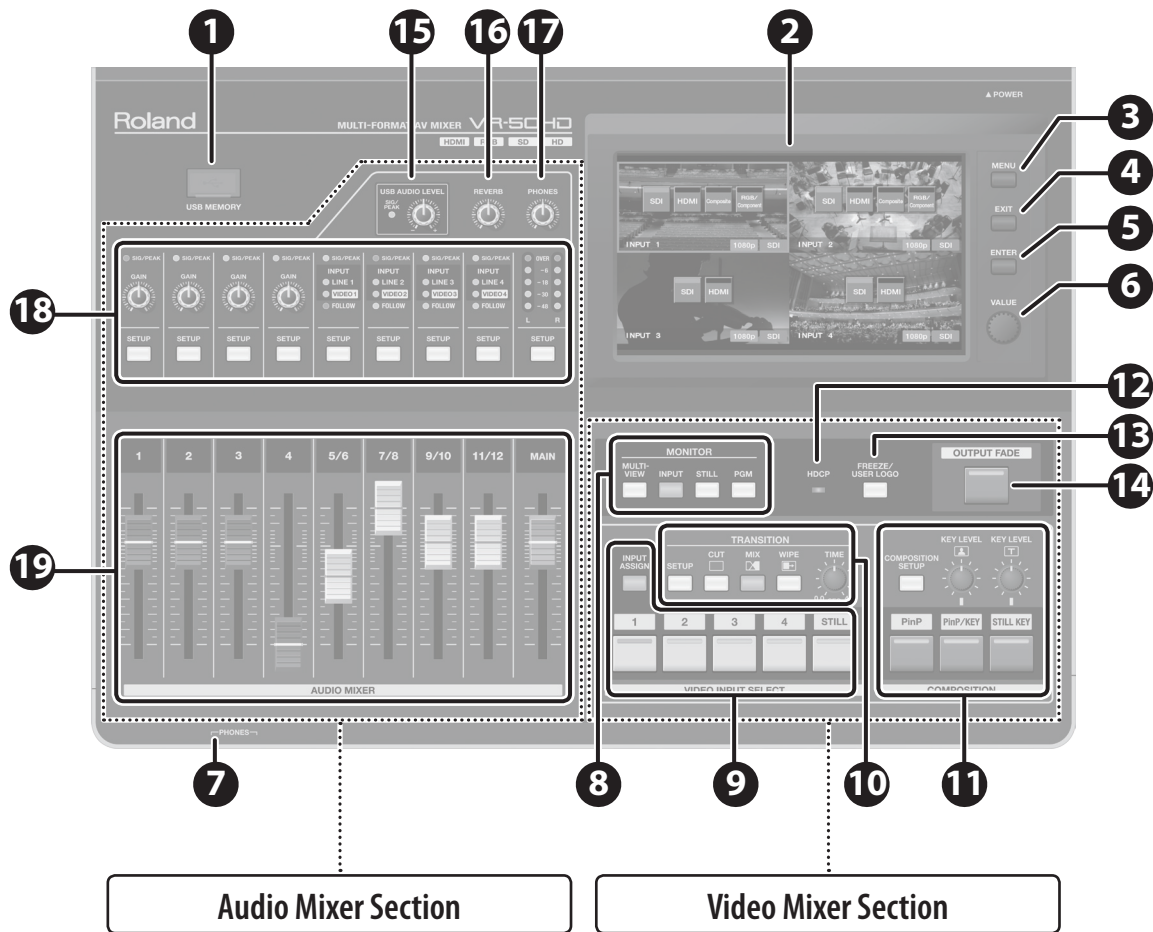

Top Panel/Front Panel



No.	Name	Explanation	Page
1	USB MEMORY port	Here you connect a USB flash drive when importing still pictures or saving or loading settings. * Open the sliding cover only when using this connector. When this is not in use, be sure to keep the sliding cover closed to protect the connector inside.	p. 34
2	Monitor	This displays the inputs from the respective source devices and the output of the VR-50HD. The monitor is a touch panel, and you can switch the video and make settings for Picture-in-Picture by touching the screen. NOTE Don't touch the screen in two or more locations simultaneously; the locations cannot be detected correctly (the touch panel does not support multi-touch).	p. 9
3	[MENU] button	This displays the menu screen.	p. 13
4	[EXIT] button	This returns the display to the previous screen. It also cancels changes made to setting values.	
5	[ENTER] button	This confirms menu items and applies changes made to setting values.	
6	[VALUE] knob	This selects menu items and changes setting values.	
7	PHONES jacks	These are for connecting headphones. You can use both at the same time.	—

Video Mixer Section

This section is for making picture transitions and compositing video. You also use it to select transition effects and composition modes.

No.	Name	Explanation	Page
8	[MONITOR] buttons	You use the [MULTI-VIEW], [INPUT], [STILL], and [PGM] buttons to select the video displayed on the monitor. For information on what is displayed, refer to "Monitor Display."	p. 9
9	[VIDEO INPUT SELECT] buttons	You use these buttons to switch the video.	p. 25
	[INPUT ASSIGN] button	You use these buttons to select and assign video input connectors to each channel.	p. 16
10	[TRANSITION] buttons	You use the [CUT], [MIX], and [WIPE] buttons to select video transition effects. Pressing the [SETUP] button displays the menu screen for transition effects.	p. 24
	[TIME] knob	This adjusts the length of video transition time.	
11	[COMPOSITION SETUP] button	This displays the menu screen for video compositing.	p. 26
	[COMPOSITION] buttons	You use the [PinP], [PinP/KEY], and [STILL KEY] buttons to output the composited video.	
	[KEY LEVEL ] knob	This adjusts the degree of extraction during key compositing using PinP/KEY.	p. 28
	[KEY LEVEL ] knob	This adjusts the degree of extraction when compositing a still picture using STILL KEY.	p. 28
12	HDCP indicator	This lights up, flashes, or goes dark depending on the settings for HDCP and on whether HDCP-compatible equipment is connected.	p. 23
13	[FREEZE/USER LOGO] button	This lets you freeze the current output video or output a user logo. Button lighted: The output video is switched to a frozen picture or user logo. Button dark: Normal video is output.	p. 36
14	[OUTPUT FADE] button	You use this when applying a fade-in or fade-out to the VR-50HD's final output.	p. 25

Audio Mixer Section

This section is for mixing audio. You use its controls to adjust the input sensitivity, output levels, and other values for each channel.

No.	Name	Explanation	Page
15	[USB AUDIO LEVEL] knob	This adjusts the level of audio output via USB.	p. 21
	SIG/PEAK indicator	This lights up in red when the level of audio output via USB reaches the peak value.	
16	[REVERB] knob	This adjusts the amount of reverb applied to output.	p. 33
17	[PHONES] knob	This adjusts the output level of headphones connected to the PHONES jacks on the front panel.	—
18	Channel Strip		
1-4 channel	SIG/PEAK indicators	These indicate the input levels of their respective channels. Lighted in green: Input detected Lighted in red: Input at peak value	—
	[GAIN] knobs	These adjust the gain (input sensitivity) for their respective channels.	p. 29
	[SETUP] buttons	These call up the channel parameter screen for their respective channels and display it on the monitor.	
5/6-11/12 channel	SIG/PEAK indicators	These indicate the input levels of their respective channels. Lighted in green: Input detected Lighted in red: Input at peak value	—
	INPUT indicators	These indicate the inputs assigned to channels 5/6-11/12. VIDEO lighted: HDMI or SDI embedded audio LINE lighted: LINE 1-4 of the AUDIO IN jacks	—
	FOLLOW indicators	When the Audio Follow feature is on and a channel has been selected for the video to follow, these light up in red. These flash in red during video transitions.	p. 32
	[SETUP] buttons	These call up the channel parameter screen for their respective channels and display it on the monitor.	p. 29
MAIN	Level meter	This indicates the audio output level of the VR-50HD. If OVER lights up, distortion might occur. Adjust the output to a level where OVER does not light up.	p. 31
	[SETUP] button	These call up the channel parameter screen for their respective channels and display it on the monitor.	p. 30
19	Audio mixer	You use this to perform level adjustment and mixing for the audio inputs from the respective channels. You adjust the VR-50HD's output level using the [MAIN] fader.	p. 31

Rear Panel

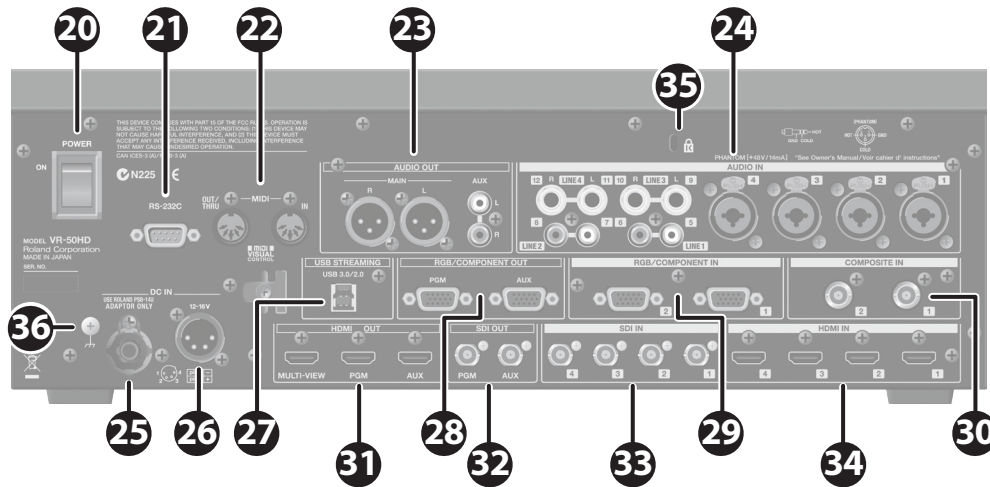

No.	Name	Explanation	Page
20	[POWER] switch	This turns the power to the VR-50HD on and off.	p. 12
21	RS-232C connector	Here you connect a device used for remote control (such as a computer equipped with a functional RS-232C interface).	p. 43
22	MIDI IN, MIDI OUT/THRU connectors	Here you connect a MIDI device used for remote control.	
23	AUDIO OUT connectors/jacks	These connectors output the final audio mix. You connect amplifiers, speakers, and recording equipment (such as video recorders) to these.	p. 19
24	AUDIO IN connectors/jacks	These are the connectors for audio input. You connect microphones, external audio mixers, CD players, or other audio sources to these. * The XLR connectors can supply phantom power (+48 V).	p. 17
25	AC adaptor jack	This is for connecting the included AC adaptor.	p. 12
26	External power connector	This is for connecting an external power source.	
27	USB STREAMING port	This is for connecting a computer that can then capture or streaming the audio/video.	p. 20
28	RGB/COMPONENT OUT connectors	Here you connect equipment (such as projectors) that is capable of analog RGB/component input.	p. 19
29	RGB/COMPONENT IN connectors	Here you connect computers capable of analog RGB output.	p. 15
30	COMPOSITE IN connectors	Here you connect equipment (such as video cameras and DVD players) that is capable of composite output.	
31	HDMI OUT connectors	MULTI-VIEW: Here you connect a monitor for displaying a list of inputs and outputs. PGM, AUX: Here you connect equipment such as monitors for displaying the results of video mixing.	p. 19
32	SDI OUT connectors	Here you connect video decks or other recording equipment.	
33	SDI IN connectors	Here you connect equipment (such as video cameras or video decks) that is capable of SDI output.	p. 15
34	HDMI IN connectors	Here you connect equipment (such as video cameras) that is capable of HDMI output.	
35	Security slot (K)	http://www.kensington.com/	—
36	Ground terminal	Refer to "Ground terminal."	p. 14

Monitor Display

You use the MONITOR [MULTI-VIEW]–[PGM] buttons to switch the displayed view.

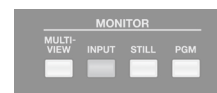

MULTI-VIEW

This displays the various inputs and outputs of the VR-50HD.

The channel currently being output is displayed with a red border. You can change the output by touching the input screen.

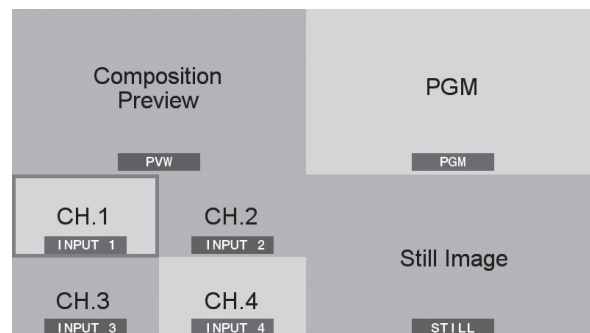

INPUT

This displays a four-way split-screen view of channels 1–4 input from source devices at video 1 to 4.

You choose this when making video transitions using the touch panel.

The channel currently being output is displayed with a red border. You can change the output by touching the input screen.

The selected input connector name and input format are displayed using icons.

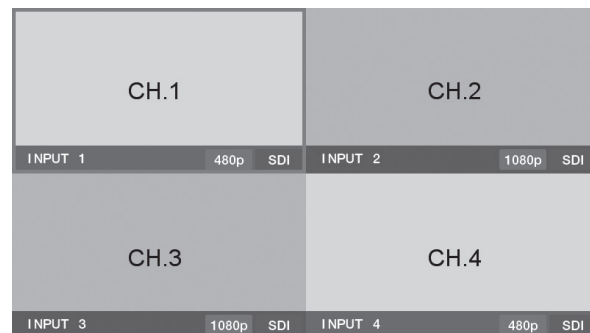

STILL

This displays a full-screen view of still images.



PGM

This displays a full-screen view of the current video output.



Signal Flow

Signal flow inside the VR-50HD is as shown in the figure below.

Video signals

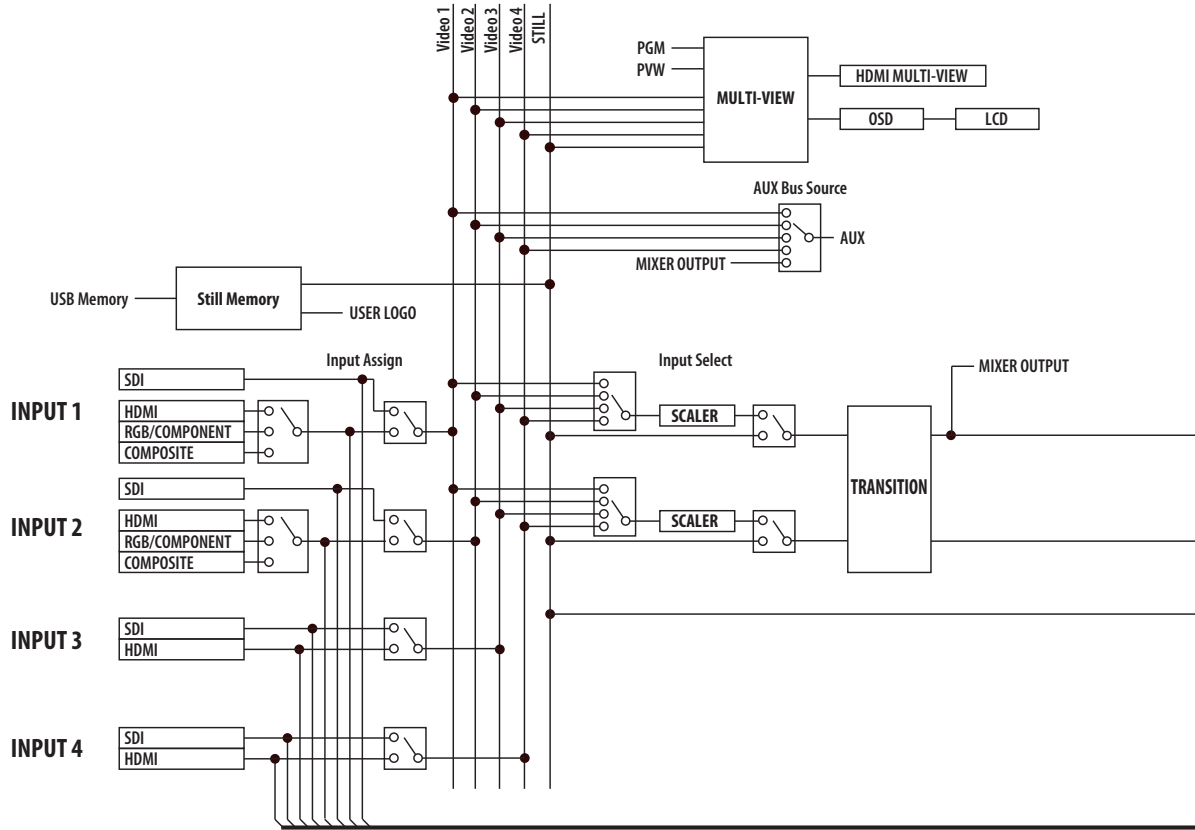

Audio signals

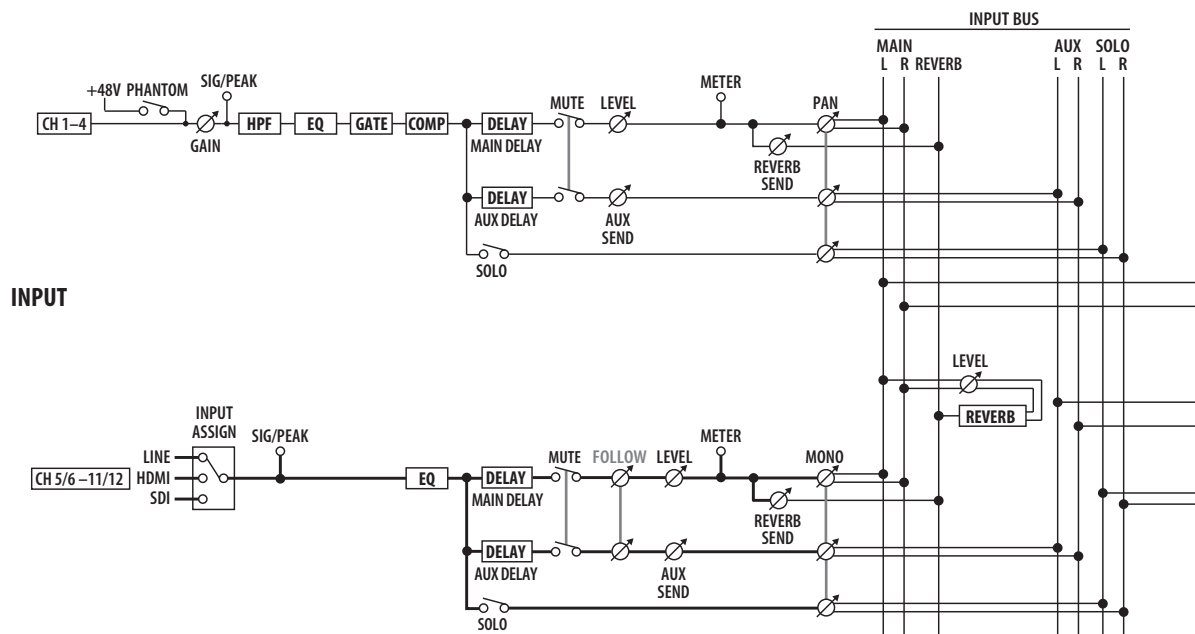

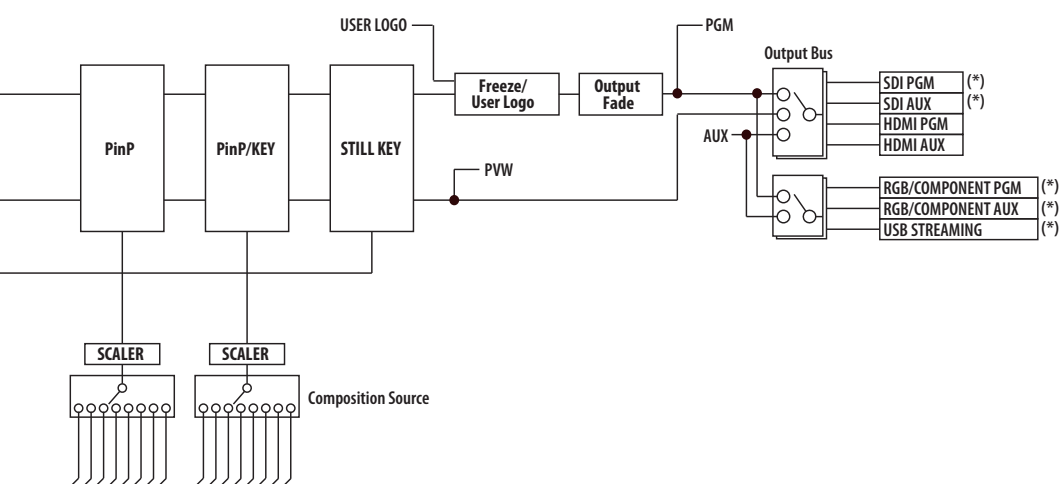

OUTPUT

(*) When HDCP is set to ON (p. 23), no audio and video signals are output from these connectors.

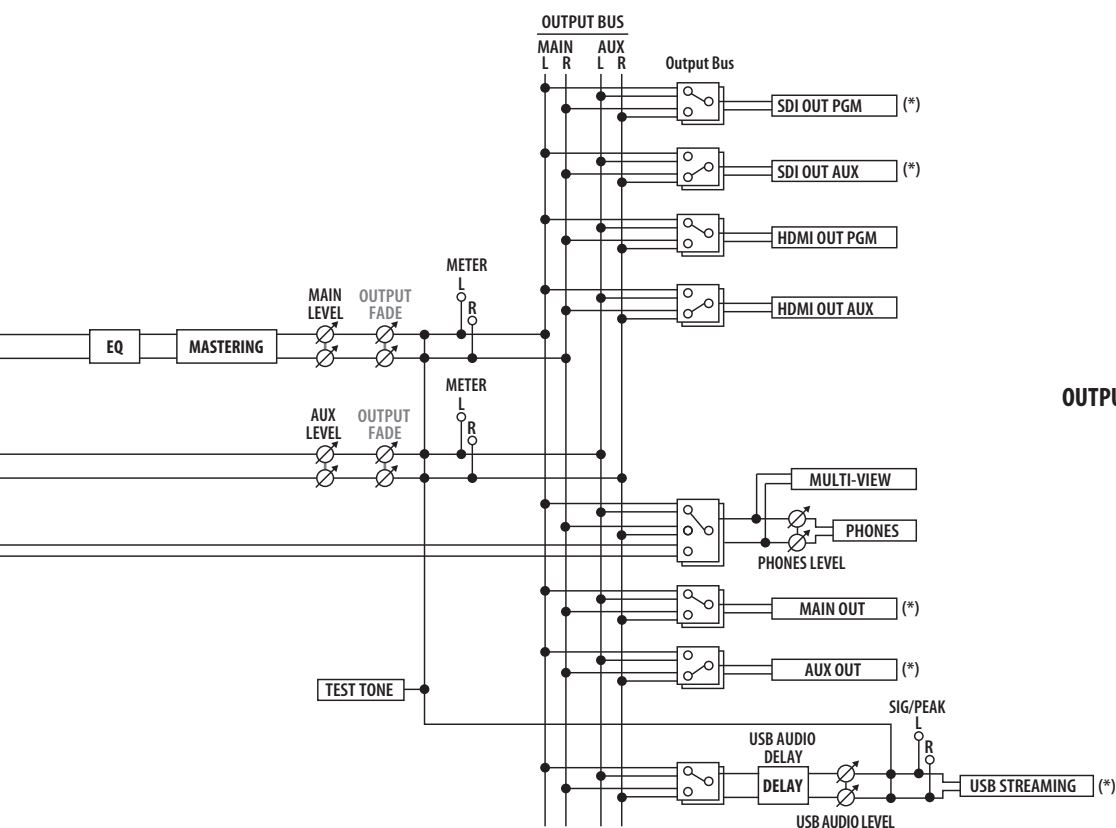

OUTPUT

(*) When HDCP is set to ON (p. 23), no audio and video signals are output from these connectors.

Preparations for Power-Up

Connecting the AC Adaptor

Connect the AC adaptor as shown in the figure.

NOTE

First connect the AC adaptor to the AC adaptor connector on the VR-50HD, and then plug the power cord into a power outlet.

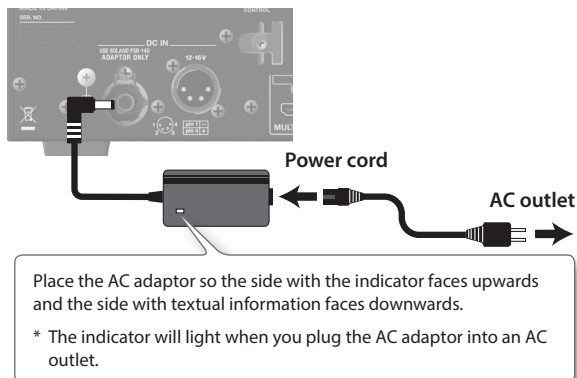

To prevent the inadvertent disruption of power to your unit (should the plug be pulled out accidentally), and to avoid applying undue stress to the AC adaptor jack, anchor the power cord using the cord hook, as shown in the illustration.

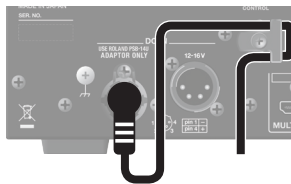

Using an External Power Source

The VR-50HD can use an external power source.

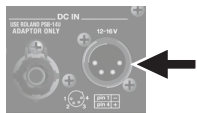

NOTE

- Use an external power source that can supply at least 90 W of current.
- Make sure that the wiring of the external power source you want to connect matches the external power connector on the VR-50HD. Connecting an external power source that has different wiring might cause malfunction.
- Be sure to use an external power source that has the voltage within DC 12 V–16 V. Using an external power source that has out of the voltage range may cause damage to the unit and the external power source.

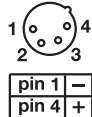

Using the AC adaptor and an external power source at the same time is also possible. When doing so, the AC adaptor becomes the “main power supply” and the external power source becomes the “backup power supply.”

If either power source fails to supply sufficient current, operation automatically switches to the other.

For information on the compatibility of external power sources, check this website.
<http://www.roland.com/support/>

When using an external power source, be sure to refer to the owner’s manual for the power source.

Turning the Power On and Off

Once everything is properly connected (p. 14), be sure to follow the procedure below to turn on their power. If you turn on equipment in the wrong order, you risk causing malfunction or equipment failure.

Turning the power on

- * Before turning the unit on/off, always be sure to turn the volume down. Even with the volume turned down, you might hear some sound when switching the unit on/off. However, this is normal and does not indicate a malfunction.
- * At powerup, the VR-50HD automatically recalls the settings saved in Memory No. 1. Depending on the settings recalled, input sounds might be produced even if the volume levels (faders) have been lowered, but this does not indicate a malfunction.

1. Make sure all devices are turned off.
2. Turn on the power to the VR-50HD.

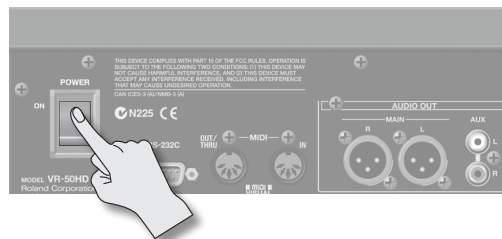

- * This unit is equipped with a protection circuit. A brief interval (a few seconds) after turning the unit on is required before it will operate normally.

3. Turn on the power to the source devices.

Turn on the power to video cameras or other source equipment connected to input connectors on the VR-50HD.

4. Turn on the power to the output devices.

Turn on the power to projectors or other devices connected to output connectors on the VR-50HD.

Turning the power off

5. Turn off the power in this sequence: output devices → source devices → the VR-50HD.

Menu Operations

You use the [MENU] button and the [VALUE] knob, or the touch panel, to make various settings.

MEMO

For detailed information on menu items, refer to the "Reference Manual" (PDF) for the VR-50HD, which can be downloaded from the following Roland website.

<http://www.rolandsystemsgroup.net/>

1. Display the menu screen.

Pressing the [MENU] button displays the menu screen.

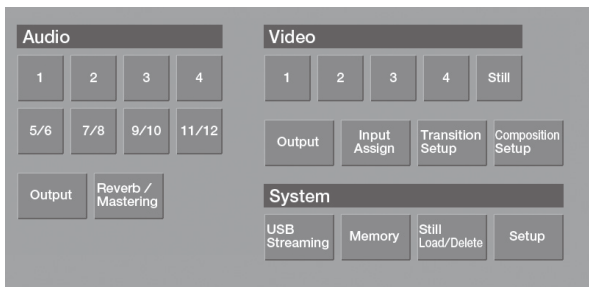
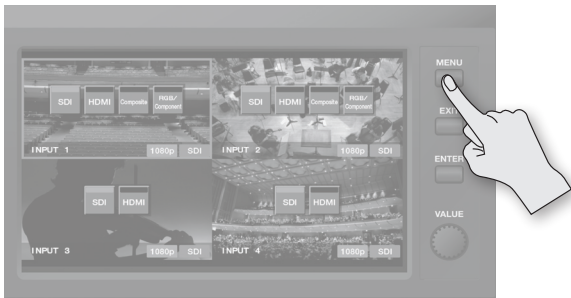

2. Touch the screen to select the item whose setting you want to make.

The parameter setting screen appears.



- When the parameters cannot be displayed on a single screen,

◀ and ▶ appear at the bottom of the screen.

You can switch screens by touching ◀ or ▶.

3. Touch the screen to select a parameter to set.

The selected parameter is displayed in red.



4. Turn the [VALUE] knob to change the setting value.

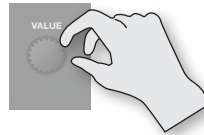

- When the setting is an on/off value, every touch of the parameter switches the value on or off. Values that have been switched on are displayed in green.
- When the setting value is displayed by a button icon, touching the button selects the value.

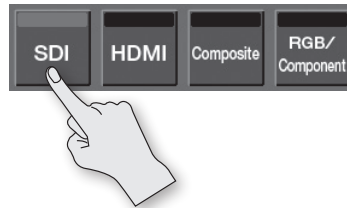

- You can change a setting value rapidly by holding down the [ENTER] button and turning the [VALUE] knob.
- Holding down the [ENTER] button and pressing the [EXIT] button returns the currently selected parameter to its initial value. Continuing to hold down these buttons returns related parameters displayed on the same screen to their initial values.

5. Press the [EXIT] button to return the original screen.

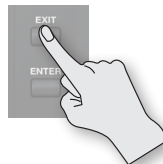

- Pressing the [MENU] button quits the menu screen.

If the MEMORY screen's "Auto Store" setting (p. 39) is set to ON, the state in effect when you exit the menu screen is automatically saved on Memory No. 1.

Connecting External Equipment

You connect external equipment as shown in this chapter. For information on specific connection methods, refer to the following pages.

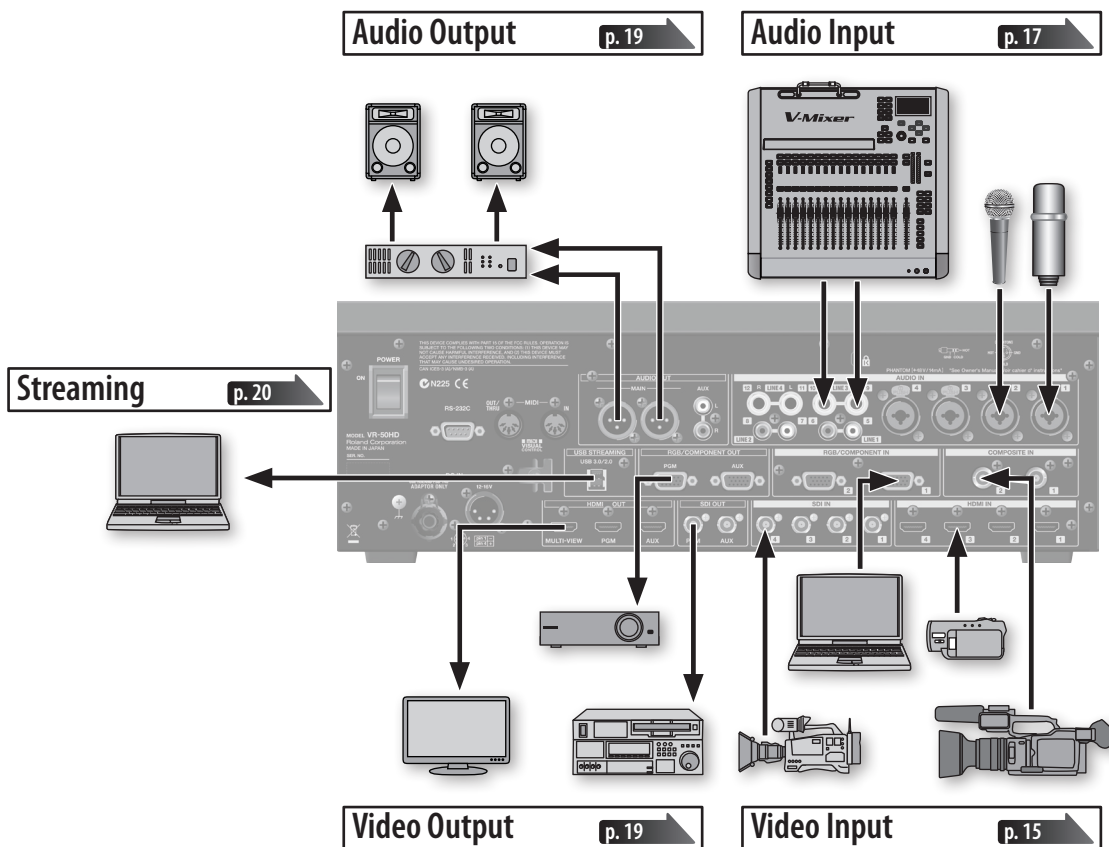

* To prevent malfunction and equipment failure, always turn down the volume, and turn off all the units before making any connections.

* This instrument is equipped with balanced (XLR/TRS) type connectors. Wiring diagrams for these jacks are shown below. Make connections after first checking the wiring diagrams of other equipment you intend to connect.



AUDIO IN 1-4 connectors

AUDIO OUT MAIN connectors

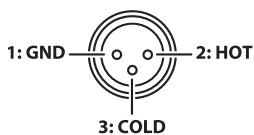

* Feedback could be produced depending on the location of microphones relative to speakers. This can be remedied by:

1. Changing the orientation of the microphone(s).
2. Relocating microphone(s) at a greater distance from speakers.
3. Lowering volume levels.

Ground terminal

Depending on the circumstances of a particular setup, you may experience a discomforting sensation, or perceive that the surface feels gritty to the touch when you touch this device, microphones connected to it, or the metal portions of other objects. This is due to an infinitesimal electrical charge, which is absolutely harmless. However, if you are concerned about this, connect the ground terminal (see figure) with an external ground. When the unit is grounded, a slight hum may occur, depending on the particulars of your installation. If you are unsure of the connection method, contact the nearest Roland Service Center, or an authorized Roland distributor, as listed on the "Information" sheet.

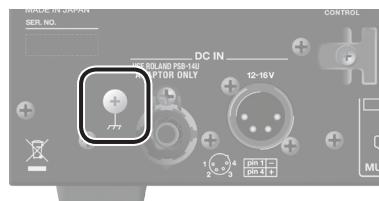

Unsuitable places for connection

- Water pipes (may result in shock or electrocution)
- Gas pipes (may result in fire or explosion)
- Telephone-line ground or lightning rod (may be dangerous in the event of lightning)

Connecting Video Source Equipment

NOTE

After making the connections, be sure to press the [INPUT ASSIGN] button and select the desired video input connectors for channels 1–4 (p. 16).

Making HDMI Connections

Connect video cameras and other devices provided with HDMI output to HDMI IN connectors 1–4.

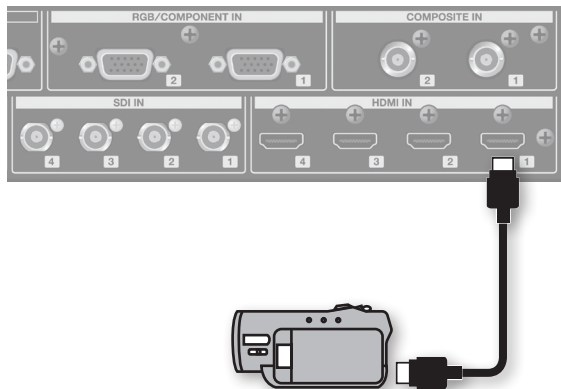

MEMO

When connecting a device provided with DVI output, use a DVI-HDMI conversion cable to make the connection to one of HDMI IN connectors 1–4.

Making SDI Connections

Connect video cameras, video decks, and other SDI devices to SDI IN connectors 1–4.

The type of signal output from the source device (3G-SDI, HD-SDI, or SD-SDI) is detected automatically.

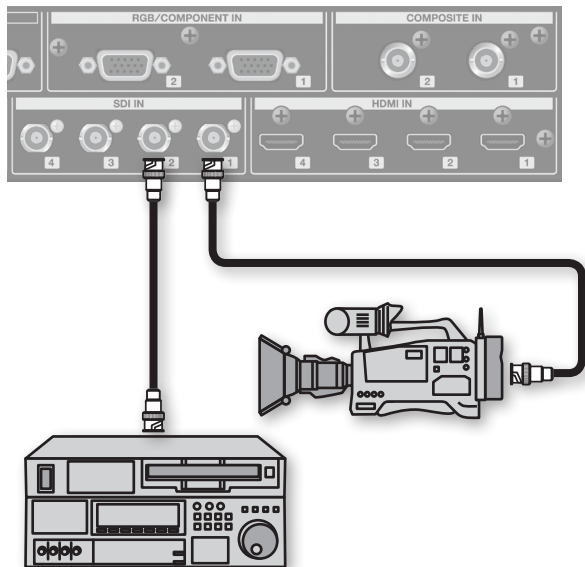

Making RGB/Component Connections

Connect computers provided with analog RGB output to the RGB/COMPONENT IN connectors (channels 1 and 2 only).

For equipment provided with component output, make the connection using a conversion cable for component to mini D-Sub 15-pin type connectors.

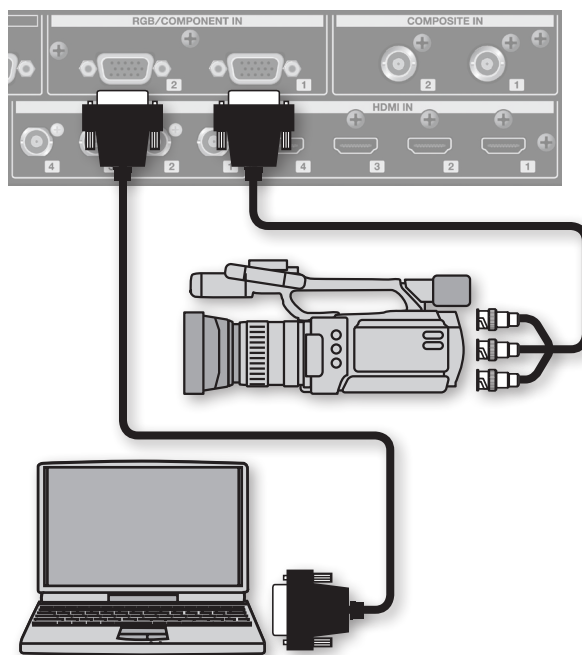

Making Composite Connections

Connect video cameras, DVD players, and other devices provided with composite output to the COMPOSITE IN connectors (channels 1 and 2 only).

* When connecting equipment that has an RCA phono type output jack, use the included RCA-BNC conversion plug.

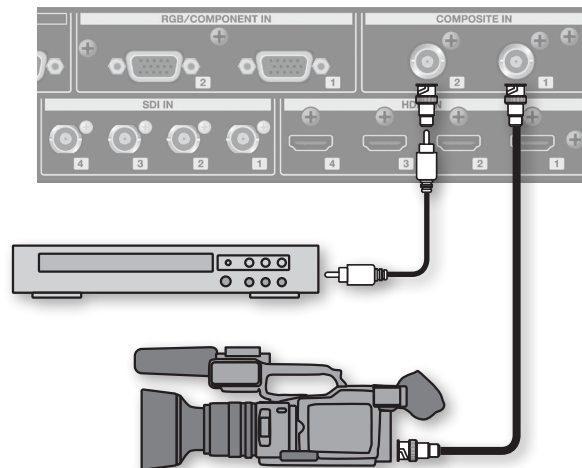

Assigning Video Sources to Channels

You assign video connectors receiving input to channels 1–4.

1. Press the [INPUT ASSIGN] button.

The names of selectable video connectors are displayed over the video on channels 1–4.

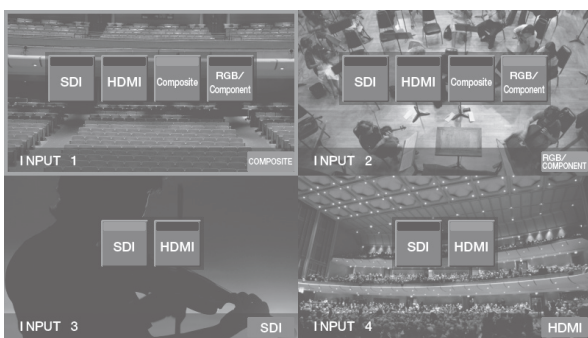
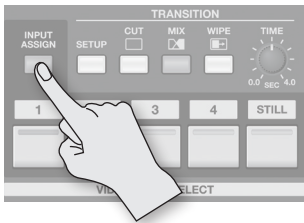

2. Touch a connector name to assign the chosen video connector to the channel.

3. Press the [EXIT] button or the [INPUT ASSIGN] button to finish making settings.

Connecting Audio Source Equipment

* Channels 1–4 are mono, and channels 5–12 operate as stereo pairs.

Connecting Microphones

Connect microphones to AUDIO IN connectors 1–4.

MEMO

This unit supports phantom power. When using a condenser microphone that requires phantom power, carry out the procedure in "Using Phantom Power" (p. 18) to set +48 V to ON.

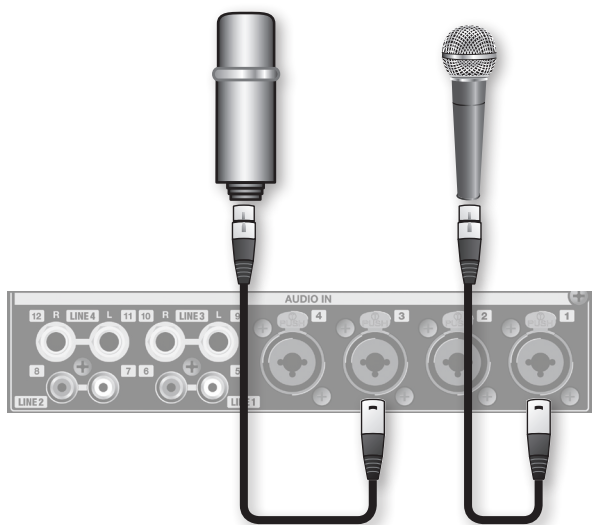

Connecting Playback Equipment

You connect audio output from equipment such as video decks and CD players to the AUDIO IN jacks.

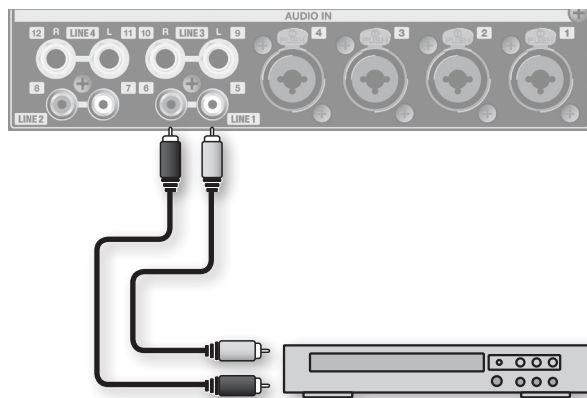

Connecting an External Audio Mixer

When you have a large number of audio channels, such as when you're recording a band performance, you make the connections to the AUDIO IN jacks via an external audio mixer.

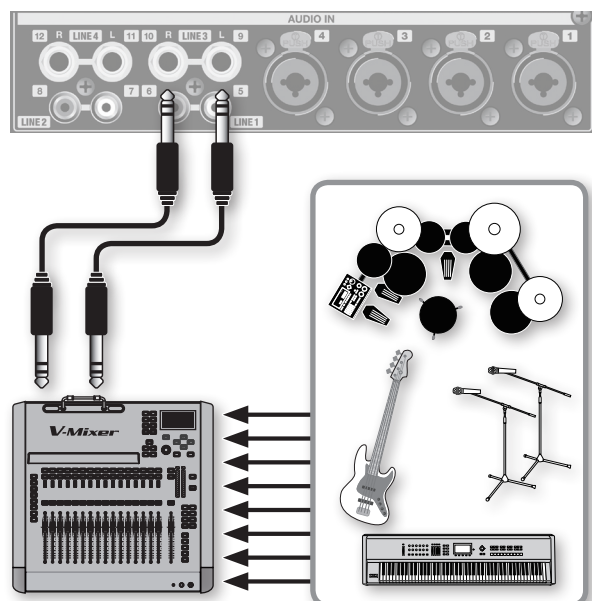

Using Phantom Power

NOTE

- Always turn the phantom power off when connecting any device other than condenser microphones that require phantom power. You risk causing damage if you mistakenly supply phantom power to dynamic microphones, audio playback devices, or other devices that don't require such power. Be sure to check the specifications of any microphone you intend to use by referring to the manual that came with it. (This instrument's phantom power: +48 V DC, 5 mA Max)
- Phantom power is not supplied to channels 5/6–11/12.

1. Press the [SETUP] button for the channel that requires phantom power, making the button light up.

The channel parameter screen appears.

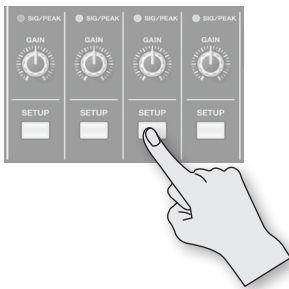

2. Touch <+48 V> to set it to "ON!"
3. Press the [EXIT] button or the illuminated [SETUP] button to finish making the settings.

Assigning HDMI/SDI Audio to Channels

Channels 1–4 are exclusively for analog input, but channels 5/6–11/12 can also be assigned to audio input via HDMI or SDI. Use the following procedure to change assignments.

1. Press the [SETUP] button for the channel whose assignment you want to change, making the button light up.

The channel parameter screen appears.

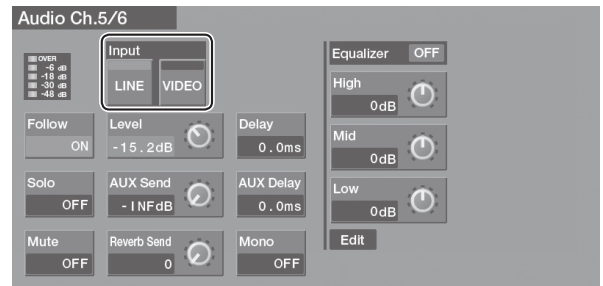
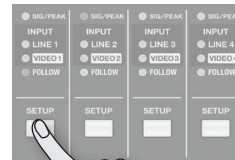

2. Touch Input <VIDEO>.

Value	Explanation
LINE	Line input is selected.
VIDEO	Depending on the input connector assigned to the channel, audio embedded in HDMI or SDI input is selected.

- * Audio channels 5/6–11/12 correspond respectively to video inputs 1–4 at LINE 1–4.
- * Channel 1 and channel 2 of audio embedded in the SDI or HDMI input are input on the audio channels.

3. Press the [EXIT] button or the illuminated [SETUP] button to finish making the settings.

Connecting Output Equipment

You connect devices to the respective output connectors for video and audio.

Connecting Video Output Equipment

Making RGB/Component connections

Connect projectors and other devices provided with analog input to the RGB/COMPONENT OUT connectors.

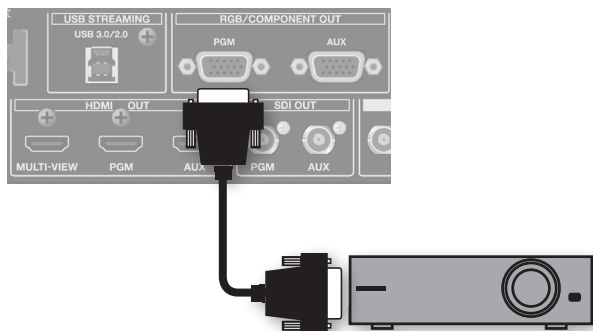

PGM	The final video signal processed by the VR-50HD itself is output.
AUX	A video signal allowing previewing the results up through video compositing is output.

* You can use Video Output settings to select the output bus (p. 37).

Making an SDI connection

You connect video decks (for recording) and other equipment provided with SDI input to the SDI OUT connectors.

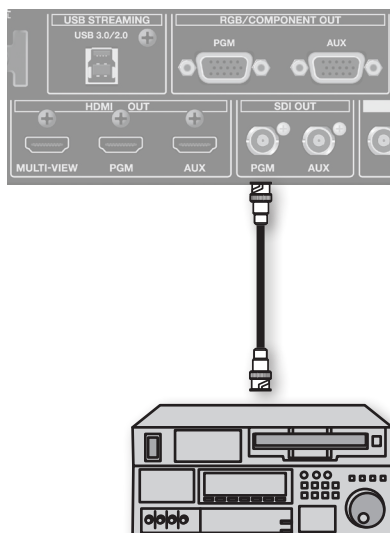

PGM	The final video signal processed by the VR-50HD itself is output.
AUX	A video signal allowing previewing the results up through video compositing is output.

* You can use Video Output settings to select the output bus (p. 37).

Making an HDMI connection

You connect television monitors and other equipment provided with HDMI input to the respective HDMI OUT connectors.

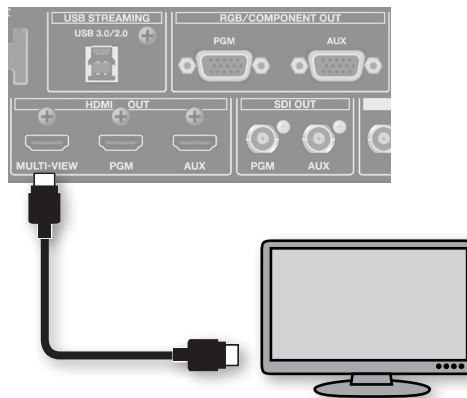

MULTI-VIEW	The display uses a screen layout similar to that used on the built-in monitor when MULTI-VIEW has been selected. Output resolution is always 1080p/60 Hz.
PGM	The final video signal processed by the VR-50HD itself is output.
AUX	A video signal allowing previewing the results up through video compositing is output.

* You can use Video Output settings to select the output bus (p. 37).

Connecting Audio Output Equipment

You connect amplifiers, speakers, and recording units to the AUDIO OUT connectors/jacks. The AUDIO OUT connectors/jacks include XLR and RCA phono type, and you can select the bus for the audio that is output from the respective connectors/jacks (p. 30).

* On the VR-50HD, the nominal output level is +4 dBu for the XLR type connectors and -10 dBu for the RCA phono type jacks. Connect equipment that is suited to the corresponding connectors/jacks.

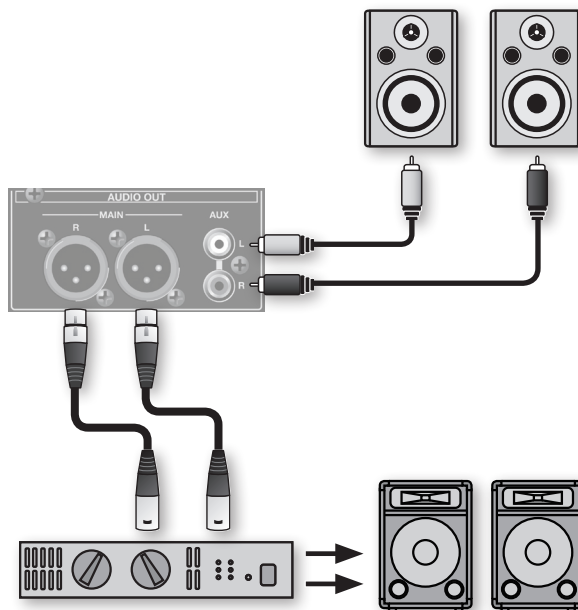

Connecting a Computer for Streaming

You can take the results of video or audio mixing and output them to a computer connected to the USB STREAMING port.

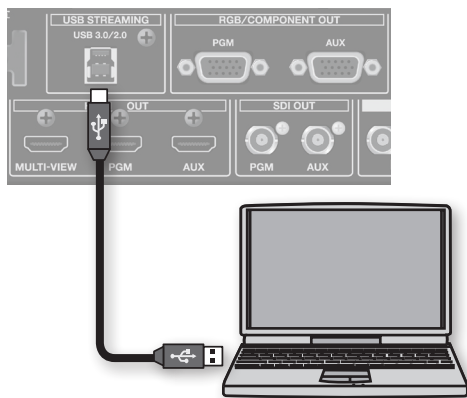
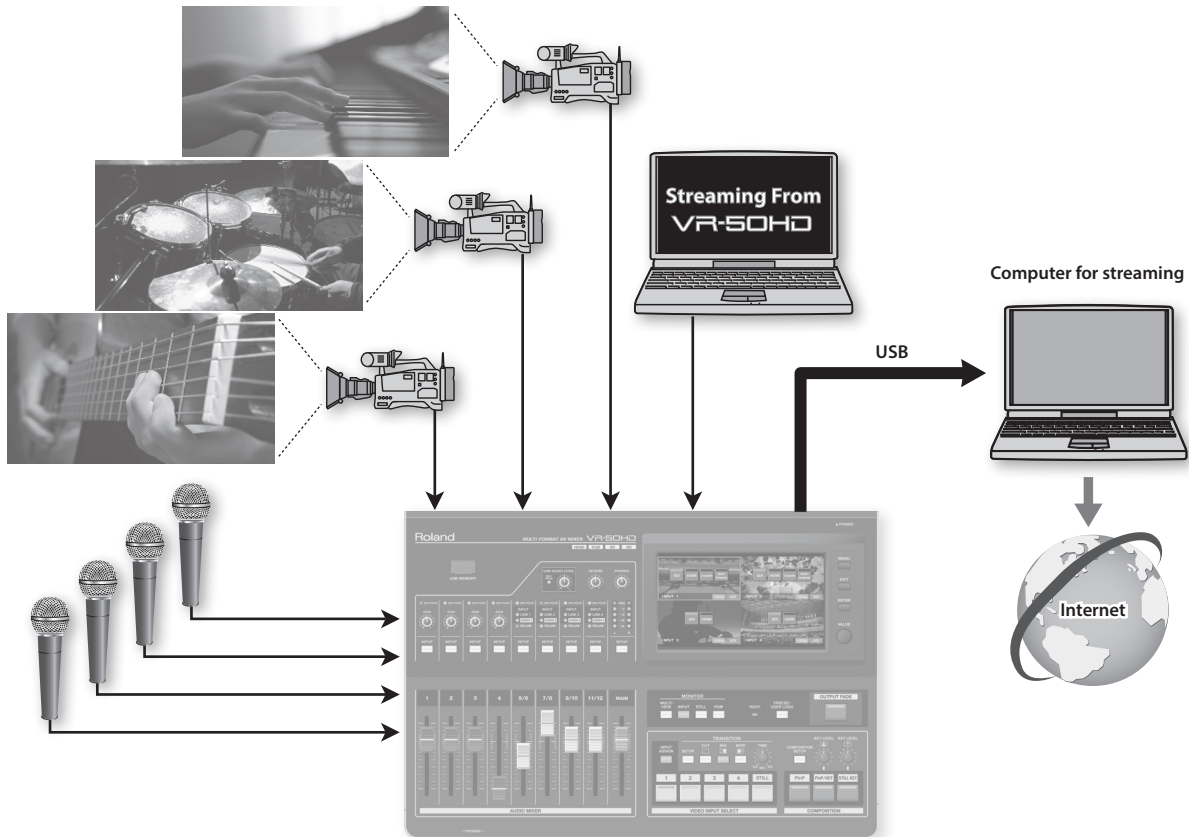

Compatible operating systems

You can make connections to computers running the following operating systems.

- Windows 7
- Windows 8
- Mac OS X 10.7 or later

* Connection and operation of the VR-50HD with standard computers running the operating systems described above have been verified, but connection and operation with all computers satisfying such conditions are not assured. Connection or operation may be impossible due to differences in setting specifications or the usage environment that are specific to the equipment.

Making the Connection to a Computer

1. Turn on the power to the VR-50HD.
2. Start the computer.
3. Using a USB cable, connect a USB 3.0 or USB 2.0 port on the computer to the USB STREAMING port on the VR-50HD.
 - * Making the connection using an extension cable or USB hub might result in the computer failing to recognize the VR-50HD. We recommend using a direct connection between the VR-50HD and the computer.
 - * When making the connection using USB 3.0, use a USB 3.0 cable.
4. Wait for communication with the computer to be established.

A short while after making the connection, communication with the computer starts, and the standard driver for the operating system is automatically installed. Installing a special driver is not necessary.

* The computer recognizes the VR-50HD as a USB video device or USB audio device.

Outputting Streamed Video and Audio to a Computer

NOTE

For the video and audio signals from the VR-50HD to be viewed and heard correctly on the computer, software that supports USB video class and USB audio class must be installed and set up on the computer.

Making the Settings for Streaming

1. Display the menu screen (p. 13).
2. Touch System <USB Streaming>.
The USB Streaming screen appears.

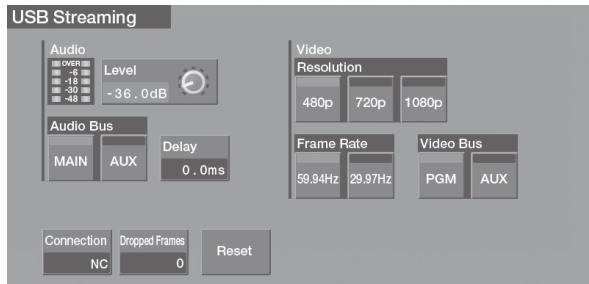

Making the settings for video

3. Make the settings for the video to output.

Parameter	Explanation
Resolution	This selects the format of the output.
Frame Rate	This selects the frame rate.
Video Bus	This specifies either the PGM bus or the AUX bus for the signals output via the USB Streaming port.

Checking the status of the USB connection

4. Use the Status item to check the status of the USB connection.

Item	Explanation
Connection	This indicates whether the connection is USB 2.0 or USB 3.0.
Dropped Frames	This is normally 0 (zero). An increase in this value means that video transmission is not fast enough. Lower the value for Resolution or for Frame Rate.

Making the settings for audio

5. Make the settings for the audio to output.

Parameter	Explanation
Level	This sets the volume level of the audio output via USB.
Audio Bus	This specifies either the MAIN bus or the AUX bus for the signals output via the USB Streaming port.

You can also use the [USB AUDIO LEVEL] knob on the top panel to adjust the volume level of audio output via USB.

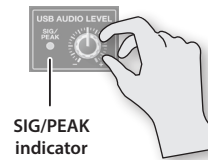

To check the volume level of the USB audio being output, you can use the level meter displayed on the USB Streaming screen or the SIG/PEAK indicator on the top panel.

Aligning the Timing of Video and Audio (Lip-sync)

This delays the audio sent to USB to correct for when video and audio in USB output are out of sync.

6. Use the computer for streaming to check whether the video and audio are out of sync.

For example, in a scene showing a drum performance, the sound of the drums being hit might be heard ahead of the video.

7. Touch <Delay>, then use the [VALUE] knob to change the setting value.

Delay the audio until it is aligned with the video.

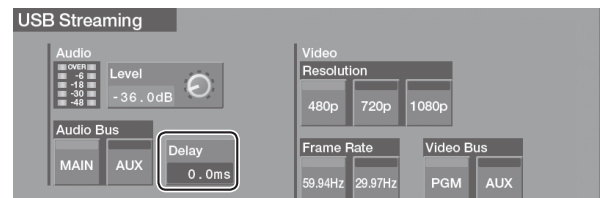

8. Press the [MENU] button to exit the menu screen.

Reconnecting with the Computer

If a USB connection with the computer for streaming fails to be established or if symptoms such as video corruption occur, use the procedure described below to make the USB connection again.

1. Display the USB Streaming screen.
2. Touch <Reset>.



Input Formats/Output Formats

This describes the video signals and formats that can be input via the input connectors, and the procedures for setting the output format for the video signal.

Formats Inputtable Via the Different Connectors

You can input signals of different formats via INPUT 1–4 on the VR-50HD.

Signals of the formats shown below can be input via the respective INPUT 1–4 connectors. The input format is detected automatically.

* Composite and RGB/component signals can input only via INPUT 1 and 2. SDI and HDMI signals can be input via INPUT 1–4.

HDMI (1–4)	480i (576i)	480p (576p)
	720p	1080i
	1080p	1024 x 768/60 Hz
	1280 x 720/60 Hz	1280 x 800/60 Hz
	1280 x 1024/60 Hz	1400 x 1050/60 Hz
SDI (1–4)	480i (576i)	720p
	1080i	1080p
COMPOSITE (1, 2)	480i (576i)	
COMPONENT (1, 2)	480i (576i)	480p (576p)
	720p	1080i
	1080p	
RGB (1, 2)	1024 x 768/60 Hz	1280 x 720/60 Hz
	1280 x 800/60 Hz	1280 x 1024/60 Hz
	1400 x 1050/60 Hz	1920 x 1080/60 Hz

NOTE

Set the frame rate of the incoming signal to match the setting for Frame Rate at the System screen (refer to the “Reference Manual” (PDF)).

* To display the System screen, touch System <Setup> in the menu screen (p. 13).

MEMO

The input format of SDI or HDMI audio is linear PCM, 24-bit/48-kHz, 2-channel.

Setting the Output Format

Here you set the format of the signal output from the video output connectors (RGB/COMPONENT, HDMI, and SDI).

1. Display the menu screen (p. 13).

2. Touch Video <Output>.

The Video Output screen appears.

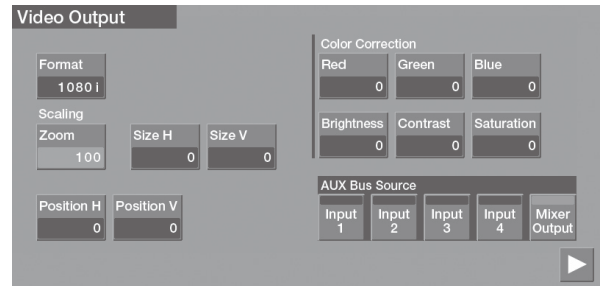

NOTE

Settings of <Red>, <Green>, and <Blue> in the Color Correction are not applied on SDI outputs.

3. Touch <Format>.

The Video Format Select screen appears.

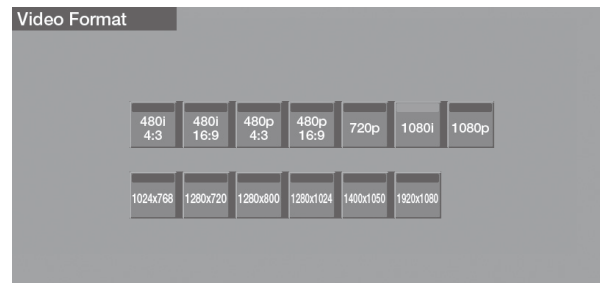

4. Touch the output format you want to set.

NOTE

When <1024 x 768>–<1920 x 1080> is selected, no signal is output from the SDI OUT connectors.

5. Press the [MENU] button to exit the menu screen.

Inputting HDCP Signals

By default, support for HDCP (High-bandwidth Digital Content Protection) on the VR-50HD is set to OFF. This means that HDCP-applied signals, such as from Blu-ray Disc players, cannot be input.

When inputting signals to which HDCP is applied, follow the procedure shown below to change the setting.

* HDCP is copyright-protection technology that prevents unlawful copying of content by encoding the path when sending digital signals from a video playback device to a display monitor or other display equipment.

1. Display the menu screen (p. 13).

2. Touch System <Setup>.

The System screen appears.

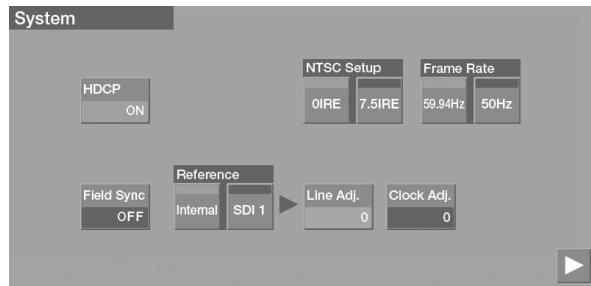

3. Touch <HDCP> to set it to ON.

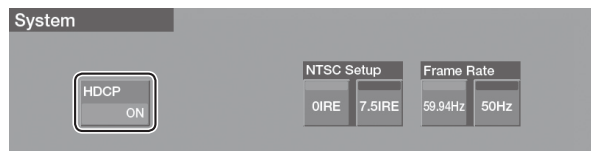

4. Press the [MENU] button to exit the menu screen.

When HDCP is set to ON, output from the connectors changes as follows.

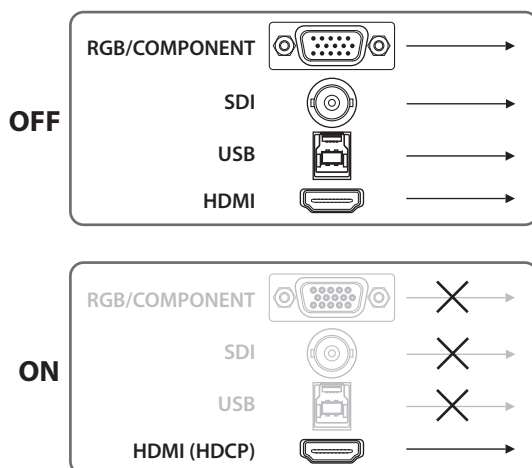

NOTE

- When HDCP is set to ON, audio is output only from the HDMI output connectors. Connect audio/video amplifiers or televisions that are HDCP-compatible.
- Audio output to headphones is always on.
- Still images captured when HDCP is set to ON cannot be used when HDCP is off (p. 38).

Operation of the HDCP indicator

The HDCP indicator on the top panel operates as follows, regardless of input.



Lighted	HDCP is set to ON and an HDCP-compatible device is connected to an HDMI OUT connector.
Flashing	HDCP is set to ON, but no HDCP-compatible device is connected to any HDMI OUT connector. Alternatively, no device that is connected is compatible with HDCP.
Dark	HDCP is set to OFF.

Checking equipment compatibility with HDCP

You can check the HDCP compatibility of source equipment. Compatibility is displayed as shown below on the INPUT screen.



Video Operations

Switching the Video

NOTE

If a fade is applied to the final output, the video is not output to a projector or other output device. For more information, refer to "Applying a Fade to Final Video Output" (p. 25).

Switching by Touching the Screen

1. Press the MONITOR [INPUT] button, making the button light up.

Input from the source equipment (channels 1–4) is displayed on the monitor.

Upon startup, the VR-50HD sets channel 1 as the default selected channel and channel 1 is displayed with a red border.

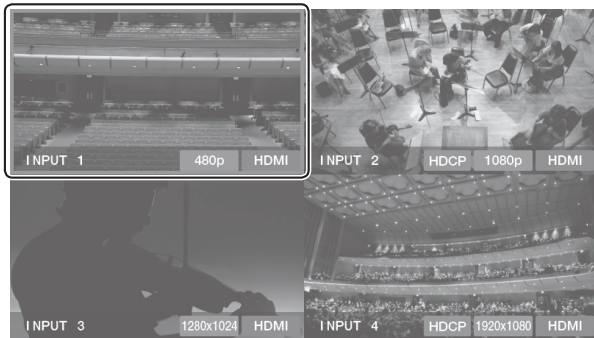
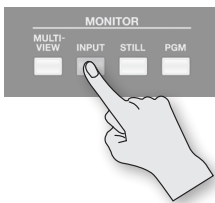

2. Press any of the TRANSITION [CUT]–[WIPE] buttons to select a transition effect.

Pressing the [CUT] button performs an instantaneous switch with no transition effect applied.

If you want to apply a transition effect, press the [MIX] button or the [WIPE] button.

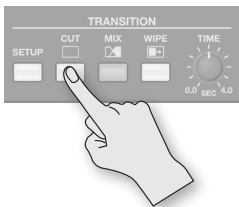

No transition effect is applied.



The two pictures are blended together as the video is switched.



The video is switched using a wipe.

3. Use the TRANSITION [TIME] knob to set the duration of the transition effect (from 0 to 4 seconds).

At a setting of 0.0, no transition effect is applied.

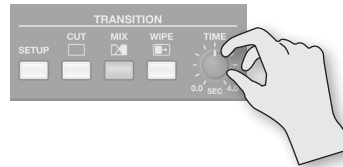

MEMO

Pressing the TRANSITION [SETUP] button displays the detailed setup screen.

Here you can set the wipe pattern and border color.

4. Touch the screen for the channel you want to output.

If you pressed the TRANSITION [MIX] or [WIPE] button in step 3, then the transition effect is applied.

During the transition time while switching from one channel to another channel, red borders are displayed around the screens for both channels.

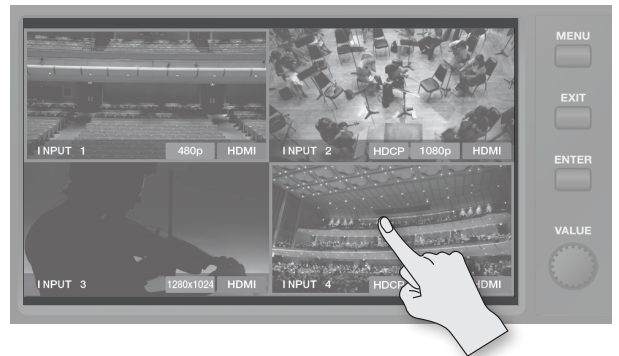

Switching the Video Using Buttons

You can also switch the video by pressing the VIDEO INPUT SELECT [1]–[4] buttons.

1. Press any of the TRANSITION [CUT]–[WIPE] buttons to select a transition effect.

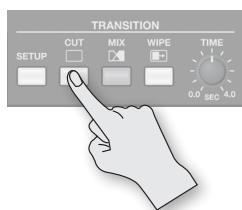

2. Use the TRANSITION [TIME] knob to set the duration of the transition effect (from 0 to 4 seconds).
3. Press one of the VIDEO INPUT SELECT [1]–[4] buttons to select the input channel you want to output from the VR-50HD.

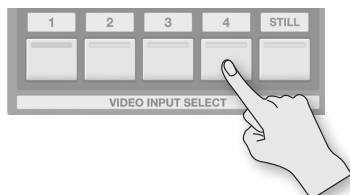

During the transition time while switching from one channel to another channel, the indicators on both channels flash.

After the transition is completed, the indicators stop flashing and the indicator for the selected channel stays lit.

MEMO

You can assign a still image saved on a USB flash drive to the INPUT SELECT [STILL] button. Refer to "Using Still-image Files" (p. 35).

Applying a Fade to Final Video Output

You can use the [OUTPUT FADE] button to apply a fade to the VR-50HD's final output.

Applying a fade makes the output video gradually disappear (fade-out) or appear (fade-in).

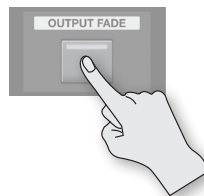

- When "MIX" or "WIPE" is selected as the transition effect, you can use the TRANSITION [TIME] knob to adjust the length of time for which the fade-out or fade-in is applied.
- When "CUT" is selected as the transition effect, the output video appears or disappears instantaneously.

Applying a Fade-out

Pressing the [OUTPUT FADE] button starts a fade-out.

The button indicator flashes while the fade is in progress.

When the fade-out has been completed, the indicator stops flashing and stays lit.

Applying a Fade-in

Pressing the [OUTPUT FADE] button a second time starts a fade-in.

When the fade-in has been completed, the indicator goes dark.

MEMO

You can specify either white or black as the fade color. At the menu screen (p. 13), touch System <Setup> to display the System screen, then make the setting for Output Fade.

Compositing Video

Three video-composition modes are available.

* If you're using STILL KEY, then it's necessary beforehand to use the procedure on p. 35 to assign a still image to the VIDEO INPUT SELECT [STILL] button.

Mode	Explanation
PinP	This displays an inset screen against a background (Picture-in-Picture).
PinP/KEY	This lets you use picture-in-picture simultaneously with key compositing.
STILL KEY	This lets you take a still image assigned to the VIDEO INPUT SELECT [STILL] button and superimpose it on background video.

Basic Operation

1. Touch the screen or press one of the INPUT SELECT [1]–[4] buttons to select the channel of the video to use for the background.
2. Press the [COMPOSITION SETUP] button to display the COMPOSITION setting screen.

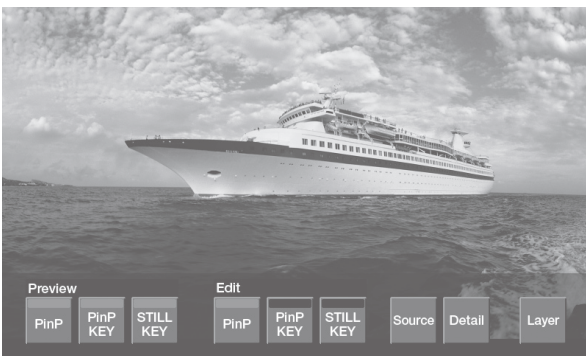
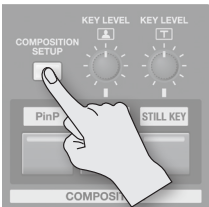

3. Touch Edit <PinP>, <PinP KEY>, or <STILL KEY> to choose the video-composition method.
4. Touch <Source>.
The Source screen appears.



5. Touch a selection from <SDI 1>–<HDMI 4> to select the connector where the video to composite is input.

When <ANALOG/HDMI 1> or <ANALOG/HDMI 2> is selected

The same connectors as the ones specified by the Input Assign settings (p. 16) are selected from the input connectors displayed in the lower row. For example, if HDMI has been selected for INPUT 1 at Input Assign, HDMI is selected at the Source screen as well.



NOTE

PinP and PinP KEY share the input connector selected using <ANALOG/HDMI 1> or <ANALOG/HDMI 2>.
Even when <Composite> has been selected for PinP, selecting <HDMI> for PinP KEY changes PinP to <HDMI> as well.

6. Press the [COMPOSITION SETUP] button to finish making the settings.
7. Composite the video.
 - “Compositing Using Picture-in-Picture (PinP)” (p. 27)
 - “Compositing Using a Key (PinP/KEY)” (p. 27)
 - “Compositing a Still Image (STILL KEY)” (p. 28)

MEMO

• You can see an on-screen preview of composition by going to the COMPOSITION setting screen, and at Preview, touching <PinP>, <PinP KEY>, or <STILL KEY>, making it light up in green.
• Going to the COMPOSITION setting screen and touching <Layer> lets you specify the order of superimposed layers to be composited. Also, touching <Detail> displays a screen for making more-detailed settings for video composition.

8. Press one of the COMPOSITION [PinP]–[STILL KEY] buttons to output the composited results.

Pressing a button outputs the video at the inset screen and the foreground.

The button's indicator lights up while output is in progress.

Pressing it a second time makes it go dark, and the inset screen and foreground video disappear.

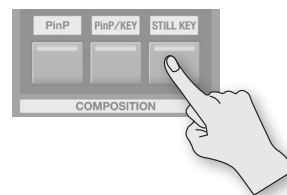

MEMO

The length of the transition-effect interval that has been set using the TRANSITION [TIME] knob is applied as the length of the fade time when the inset screen and foreground video appears and disappears.

Compositing Using Picture-in-Picture (PinP)

This displays an inset screen against a background.

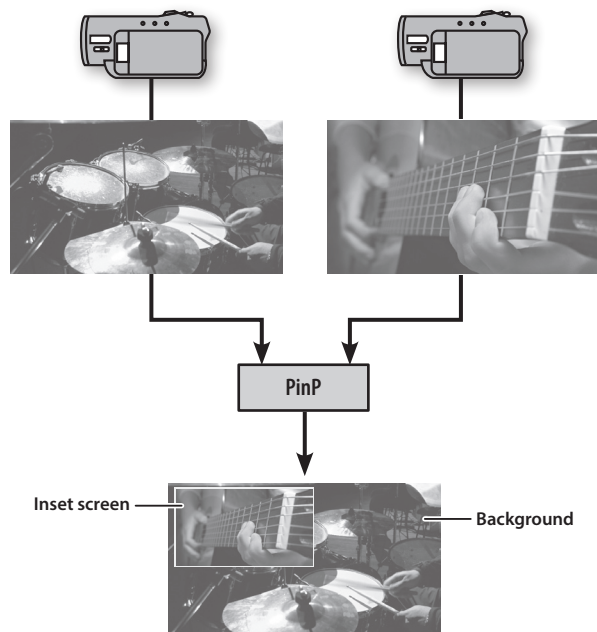

Changing the position of the inset screen

1. Touch the inset screen and drag with your finger.
The location of the inset screen moves.

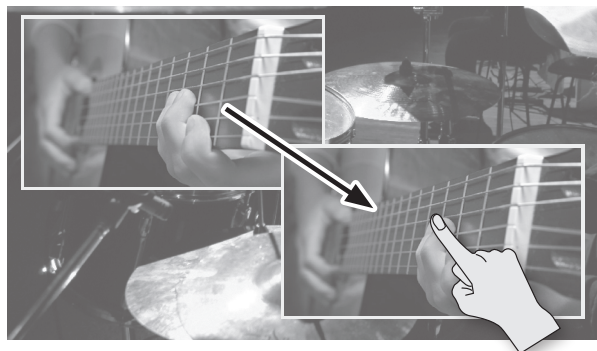

Changing the size of the inset screen

1. Turn the [VALUE] knob.
Turn clockwise to enlarge or counterclockwise to reduce.

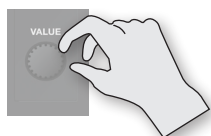

MEMO

Going to the COMPOSITION setting screen and touching <Detail> displays a screen for adding borders, scaling the picture-in-picture video, and making other more-detailed settings.

For details, refer to the "Reference Manual" (PDF).

Compositing Using a Key (PinP/KEY)

You can perform compositing such as "chroma key" and "luminance key" that superimposes video in which a specified color is transparent onto a background video.

You can also use picture-in-picture simultaneously with key compositing.

Example:

You can superimpose and composite video in which blue or green in the background is made transparent.

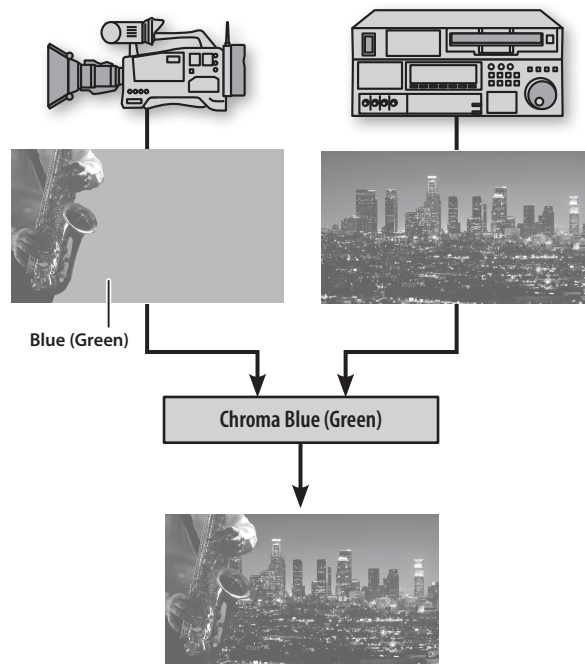

1. Press the [COMPOSITION SETUP] button to display the COMPOSITION setting screen.
2. Touch <Detail>, then touch ◀ or ▶ to switch to the screen where "KEY" is displayed.

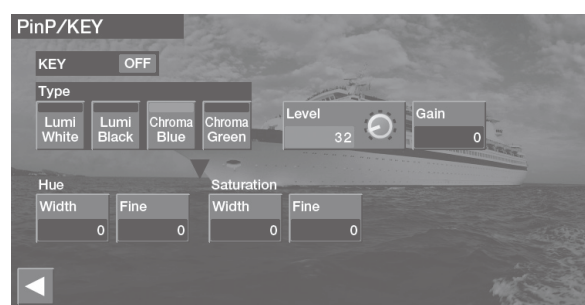

3. Touch one of the selections from Type <Lumi White>-<Chroma Green> to choose the color to make transparent in the video.

Value	Explanation
Lumi White	This uses a brightness threshold to make white transparent when compositing.
Lumi Black	This uses a brightness threshold to make black transparent when compositing.
Chroma Blue	This uses a color threshold to make blue transparent when compositing.
Chroma Green	This uses a color threshold to make green transparent when compositing.

Video Operations

4. Touch <Level>, then use the [VALUE] knob to adjust the range of color to make transparent.

* Setting Hue, Saturation, and Gain to 0 can make adjustment easier.

5. Touch <Gain>, then use the [VALUE] knob to set the range of color to make translucent.

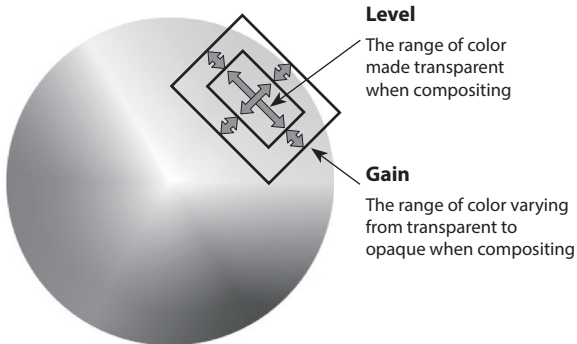

When Type is Chroma Blue or Chroma Green

You can fine-tune the Hue and Saturation settings.

Parameter		Explanation
Hue	Fine	This adjusts the center position for hue.
	Width	This adjusts the hue width (range).
Saturation	Fine	This adjusts the center position for saturation.
	Width	This adjusts the saturation width (range).

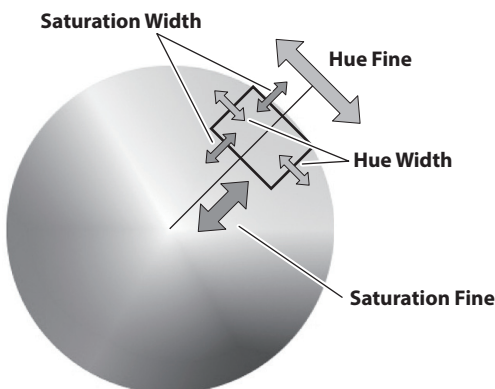

Adjusting the amount of keying

1. Turn the [KEY LEVEL] knob to adjust the amount of keying (extraction).

Turning the knob all the way counterclockwise results in no keying at all, and the background is not revealed.

Turning the knob clockwise all the way results in complete keying, and the foreground picture cannot be seen. Turn to the position where the amount of keying is just right.



* Turning this knob also changes the value of the Key Level setting at the PinP/KEY setting screen.

MEMO

- Going to the COMPOSITION setting screen and touching <Detail> displays a screen for changing the key color and making other more-detailed settings.
- When you want to make settings for picture-in-picture, go to the COMPOSITION setting screen, and at Edit, select <PinP>.

Compositing a Still Image (STILL KEY)

You can take a still image (logo or text) assigned to the VIDEO INPUT SELECT [STILL] button and superimpose it on a background video.

Example:

You can superimpose and composite a still image in which white or black in the background is made transparent.

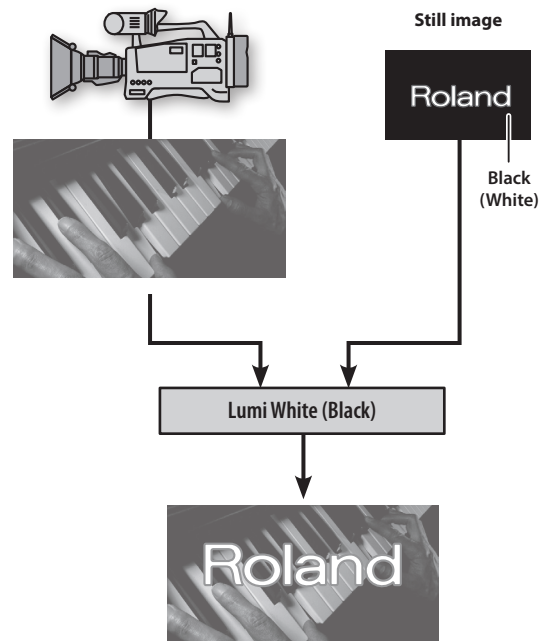

1. Press the VIDEO INPUT SELECT [STILL] button.
2. The procedures are the same as in "Compositing Using a Key" (p. 27).

Adjusting the amount of keying

1. Turn the [KEY LEVEL] knob to adjust the amount of keying.

Turning the knob all the way counterclockwise results in no keying at all, and the background is not revealed.

Turning the knob clockwise all the way results in complete keying, and the logo or text cannot be seen.

Turn to the position where the amount of keying is just right.

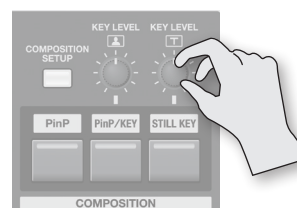

* Turning this knob also changes the value of the Key Level setting at the STILL KEY setting screen.

Audio Operations

Channel Parameter Screen

Pressing the [SETUP] button for a channel displays the channel parameter screen.

The information displayed on the screen differs for channels 1 to 4, channels 5/6 to 11/12, and MASTER (output).

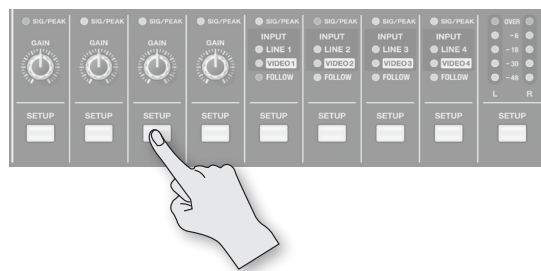

Procedure

1. Press the [SETUP] button for the channel whose settings you want to make.

The channel parameter screen appears.

2. Touch the screen to select a parameter.

3. Turn the [VALUE] knob to change the setting value.

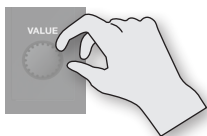

- When the setting is an on/off value, every touch of the parameter switches the value on or off.

4. Press the [EXIT] button or the illuminated [SETUP] button to finish making the settings.

NOTE

The value of a parameter is updated by the last-performed operation among those described below.

- Operations at the channel parameter screen
- Operations using knobs and faders on the top panel
- Remote operation by an external device
- Loading settings saved in the unit's memory (p. 39)

Channels 1–4

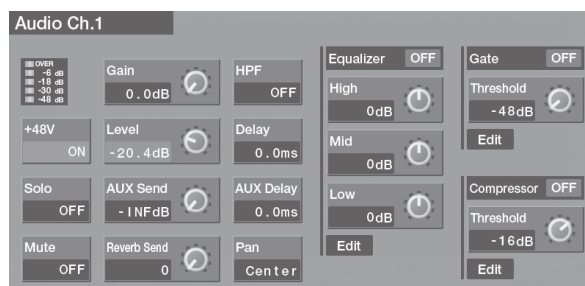

Parameter	Explanation
+48 V	You set this to ON when using a microphone that requires phantom power.
Solo	When listening to audio through headphones, you can hear just the channels for which this value is set to ON.
Mute	This mutes the audio on the selected channel.
Gain	This adjusts the input gain. You can also use the [GAIN] knobs on the top panel to adjust this.
HPF	This switches the high-pass filter (75 Hz) on and off.
Level	This adjusts the level sent to the MAIN bus. You can also use the channel faders on the top panel to adjust this.
Delay	This adjusts the amount of delay for correcting audio that is out of sync with the video (lip-sync).
AUX Send	This adjusts the level sent to the AUX bus.
AUX Delay	This adjusts the amount of delay for correcting audio and video sent to the AUX bus that are out of sync (lip-sync).
Reverb Send	This sets the amount of reverb applied.
Pan	This adjusts the left-right balance of input.
Equalizer	
ON/OFF	This switches the equalizer on and off.
High, Mid, Low	These set the gain for the corresponding frequency bands.
Edit	This displays an advanced setting screen.
Gate	
ON/OFF	This switches the gate feature on and off.
Threshold	This sets the sensitivity at which the gate starts to be applied.
Edit	This displays an advanced setting screen.
Compressor	
ON/OFF	This switches the compressor on and off.
Threshold	This sets the sensitivity at which the compressor starts to be applied.
Edit	This displays an advanced setting screen.

Channels 5/6–11/12



Parameter	Explanation
Follow	This switches the Audio Follow function on or off.
Solo	When listening to audio through headphones, you can hear just the channels for which this value is set to ON.
Mute	This mutes the audio on the selected channel.
Input	This selects the channel's audio input source. LINE: Analog audio incoming via the LINE jacks on the rear panel is input. VIDEO: Audio embedded in video is input. VIDEO is enabled when SDI or HDMI has been selected for Input Assign.
Level	This adjusts the level sent to the MAIN bus. You can also use the channel faders on the top panel to adjust this.
Delay	This adjusts the amount of delay for correcting audio that is out of sync with the video (lip-sync).
AUX Send	This adjusts the level sent to the AUX bus.
AUX Delay	This adjusts the amount of delay for correcting audio and video sent to the AUX bus that are out of sync.
Reverb Send	This sets the amount of reverb applied.
Mono	This sends the left-channel audio to the left and right channels; the right-channel audio is no longer heard.
Equalizer	
ON/OFF	This switches the equalizer on and off.
High, Mid, Low	These set the gain for the corresponding frequency bands.
Edit	This displays an advanced setting screen.

MAIN (Output)

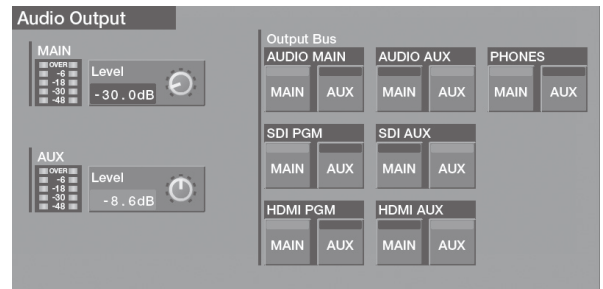

Parameter	Explanation
MAIN Level	This adjusts the output level of the MAIN bus. You can also use the [MAIN] fader on the top panel to adjust this.
AUX Level	This adjusts the output level of the AUX bus.
Output Bus	This selects whether the signals of the PGM bus or the signals of the AUX bus are output via the various output connectors. You select from among SDI PGM–HDMI AUX when audio input from HDMI or SDI has been assigned to channels 5/6–11/12.

Adjusting the Audio Balance

NOTE

The [MAIN] fader adjusts the output level of the MAIN bus only. The output level of the AUX bus can be adjusted independently (p. 30).

1. Adjust the channel parameters (p. 29).

Adjust the sensitivity (GAIN), stereo position (PAN), and tone (EQ) for each respective input.

2. Lower the faders all the way.

Move the faders for channels 1–4 and channels 5/6–11/12 all the way down.

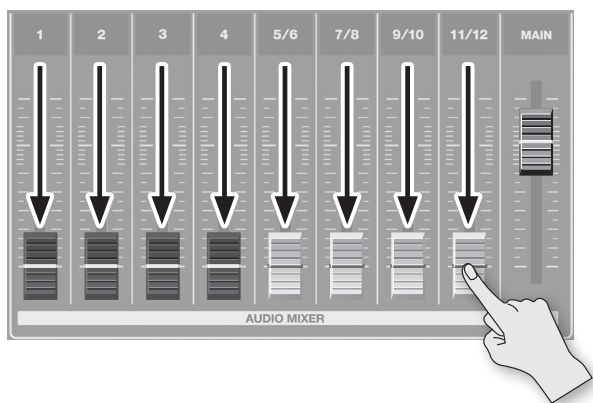

3. Raise the volume level of each channel.

Gradually raise the faders for all channels that have input. Leave lowered the faders for channels that have no input.

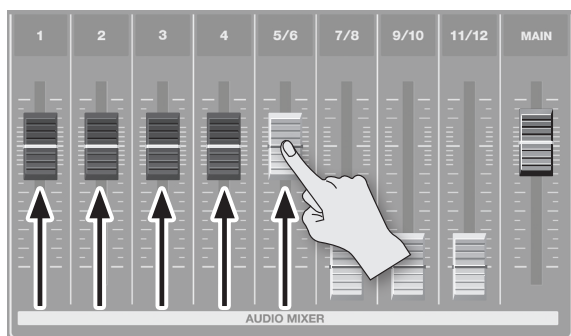

4. Adjust the volume balance for each channel.

Leave the fader untouched for a channel you want to make prominent—for example, the microphone used by a presenter—and lower the faders for the other channels.

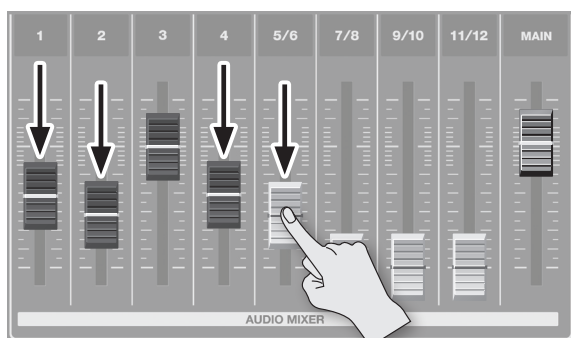

Adjusting the Final Audio Output

You can use the [MAIN] fader to adjust the volume level of the final output. Operate the fader while watching the level meter.

1. See the level meter to check the volume level of the final output.

If OVER lights up, the volume level is excessive.

If only the indicators up to -48 or -30 light up, the volume level is insufficient.

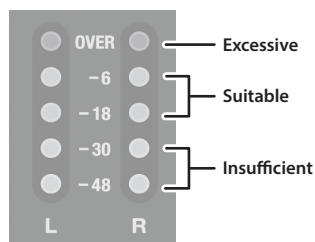

2. Move the [MAIN] fader to adjust the volume level.

A suitable level is where -18 to -6 light up at maximum input.

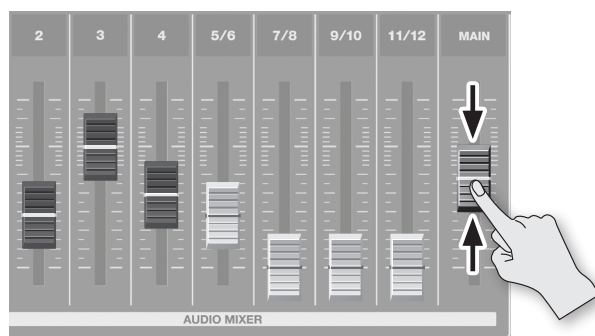

NOTE

If the volume level of speaker output is not suitable even after adjustment so that -18 to -6 light up, adjust the volume for the speakers or the amplifier. Using the [MAIN] fader to carry out further adjustment might result in distortion or degradation of sound quality

Aligning the Timing of Video and Audio (Lip-sync)

Normally, because video processing takes more time than audio processing, the video is output later than the audio, resulting in video and audio that are out of sync.

To correct this deviation, you delay the audio to align it with the video.

1. Input the audio and video from a DVD player or other source.
2. Output the video to a projector or other display device and the audio to speakers or headphones.
3. Check whether the video and audio are out of sync.
For example, in a scene showing a drum performance, the sound of the drums being hit might be heard ahead of the video.
4. Press the [SETUP] button for the channel carrying the audio input.

The channel parameter screen appears.

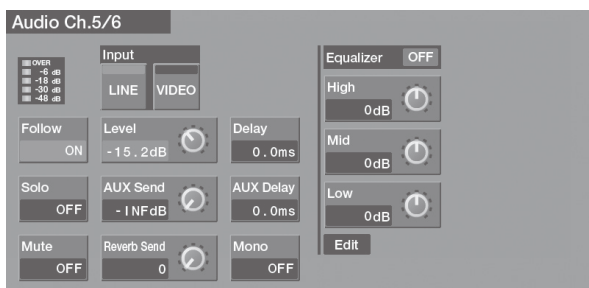

5. Touch <Delay>, then use the [VALUE] knob to change the setting value.

Delay the audio until it is aligned with the video.

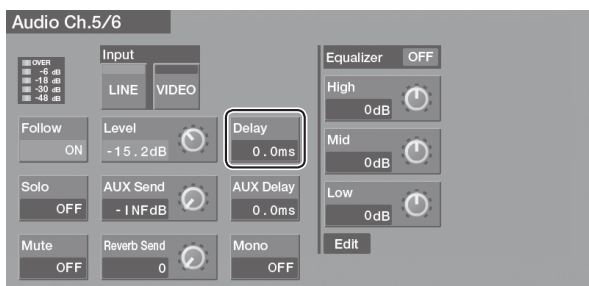

MEMO

- The amount of delay you apply to the audio depends on the entire system, including the projector.
On the VR-50HD by itself, video processing requires about two frames of time. (This varies according to the input and output formats.)
- To align the timing of audio and video on the AUX bus, touch <AUX Delay> and change the setting value.

6. Press the [EXIT] button or the illuminated [SETUP] button to finish making the settings.

Linking Audio to Video Switching (Audio Follow)

You can link audio and a video switch so that the audio is played when the video-switch operation is performed.

This function is called "Audio Follow."

When a video channel where Audio Follow is on is switched, the output volume level of the target audio channel (e.g., when the video is on channel 1, the audio is on channels 5/6) automatically changes in keeping with the transition effect in the video.

* On video channels where Audio Follow is off, audio is output according to the position of the fader.

NOTE

When this function has been switched on, the positions of the faders do not change automatically. Only the switching of output and muting changes automatically.

1. Operate the faders for channels 5/6–11/12 to adjust the volume to the level you want to output.

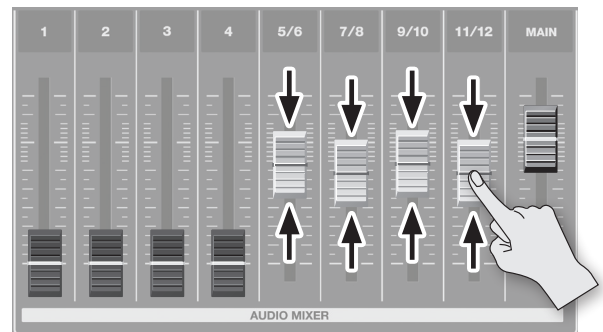

2. Press the [SETUP] button for the channel where you want to use the Audio Follow function.

The channel parameter screen appears.

3. Touch <Follow> to set it to ON.

The FOLLOW indicator for the target channels lights up in green.

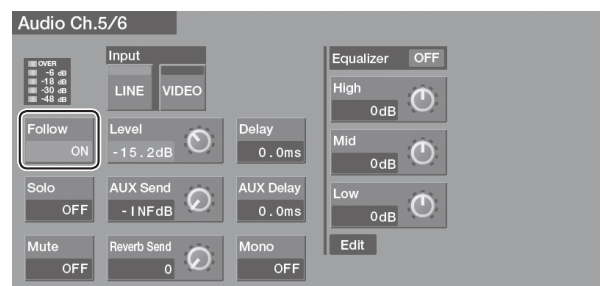

4. Switch the video channels.

When a video channel where Audio Follow is on is switched, the output volume level of the target audio channel automatically changes in keeping with the transition effect in the video.

The output at this time is at the volume level you set in step 1. Also, the FOLLOW indicator for the channel carrying the audio output lights up in red.

MEMO

Audio cross-fade is applied for the length of time set using the TRANSITION [TIME] knob for transition effects.

Applying Effects to Audio

On the VR-50HD, you can apply effects (Reverb, Equalizer, and Mastering) to audio output.

1. Display the menu screen (p. 13).
2. Touch Audio <Reverb/Mastering>.

The Reverb/Mastering screen appears.



3. Touch the effect you want to use, setting it to ON.
4. Touch the parameter, then use the [VALUE] knob to change the setting value.
5. Press the [MENU] button to exit the menu screen.

Reverb

This adds lingering reverberations to the sound.

Parameter	Explanation
Reverb ON/OFF	This switches reverb on and off.
Level	This sets the amount of reverb applied.
Time	This sets the duration of the reverb.
Type	This selects the type of reverb (Room or Hall).

You can also use the [REVERB] knob on the top panel to adjust the Level setting.

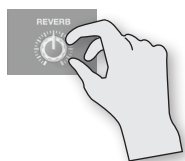

Equalizer

This adjusts the low-frequency, middle-frequency, and high-frequency volume levels.

Parameter	Explanation
Equalizer ON/OFF	This switches the equalizer on and off.
High	This adjusts the volume level of the high-frequency.
Mid	This adjusts the volume level of the middle-frequency.
Low	This adjusts the volume level of the low-frequency.
Edit	This displays an advanced setting screen.

Mastering

This adjusts the dynamic range and tone quality.

Parameter	Explanation
Mastering ON/OFF	This switches mastering on and off.
High	This suppresses high-frequency distortion.
Mid	This suppresses middle-frequency distortion.
Low	This suppresses Low-frequency distortion.
NS	This adjusts the degree of application of the noise suppressor.
Enhancer	This adjusts the degree of application of the enhancer.

Other Functions

Formatting USB Flash Drives

To use a USB flash drive, it must first be formatted on the VR-50HD.

NOTE

- USB flash drives not formatted using the VR-50HD are not recognized.
- Performing formatting causes all data already saved on the USB flash drive to be lost. Before you carry out formatting, be sure to check whether the USB flash drive holds any data you want to keep.

Connecting

Carefully insert the USB flash drives all the way in—until it is firmly in place.

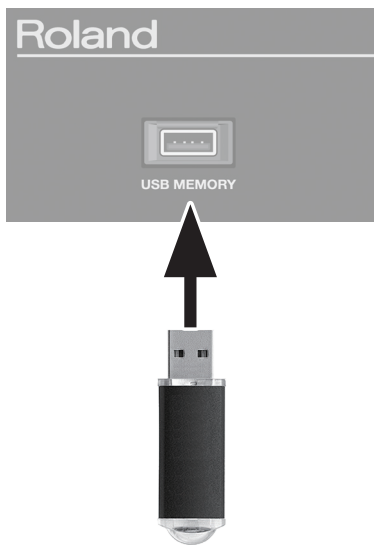

* Never turn off the power or disconnect the USB flash drives while the screen indicates "Processing."

NOTE

It may take for a while before you can operate files on a USB flash drive after you connect the USB flash drive to the VR-50HD.

Formatting

1. Display the menu screen (p. 13).

2. Touch System <Memory>.

The Memory screen appears.

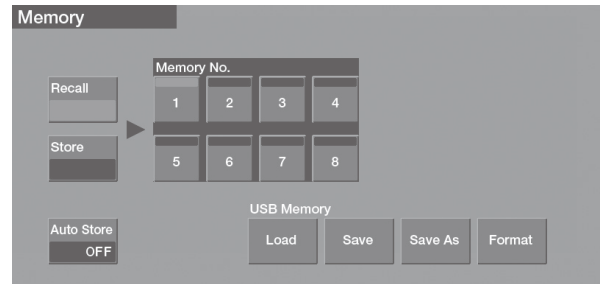

3. Touch USB Memory <Format>.

A confirmation prompt appears.

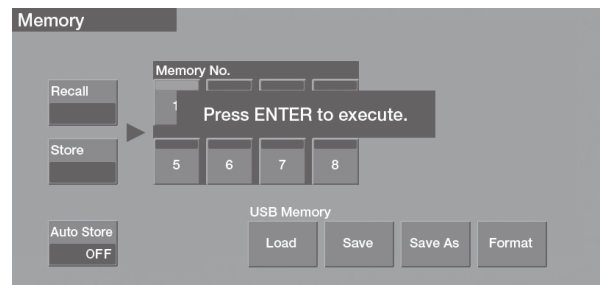

4. To perform formatting, press the [ENTER] button.

To cancel, press the [EXIT] button.

5. Press the [MENU] button to exit the menu screen.

Using Still-image Files

On the VR-50HD, you can assign a still image to the VIDEO INPUT SELECT [STILL] button and work with it in the same way as video.

You import the still-image file from a USB flash drive that you connect to the VR-50HD.

Format and resolution of the still images

Save still-image data in the root directory of a USB flash drive, using the format and resolution described below.

Data in other formats or sizes cannot be imported.

Format	Bitmap (.bmp), 24 bits/pixel, uncompressed
Resolution	Maximum 1,920 x 1,280

NOTE

Still images cannot be scaled. Before you import the image, make sure it is already at the proper resolution for the final format.

Importing still images

You import a still image saved on a USB flash drive into the VR-50HD and assign it to the VIDEO INPUT SELECT [STILL] button.

NOTE

- Still images are deleted when the VR-50HD's power is turned off.
- Turning on the power while a USB flash drive containing a still image is inserted causes the still-image file imported before the power was turned off to be automatically imported from the USB flash drive.

1. Save the still-image file in the root directory of the USB flash drive.

Use a file name containing no more than eight single-byte alphanumeric characters, and be sure to add the ".bmp" file extension.

2. Connect the USB flash drive containing the saved still-image file to the USB MEMORY port.

3. Display the menu screen (p. 13).

4. Touch System <Still Load/Delete>.

The Still Load/Delete screen appears.



5. Touch <1>-<4> to select the destination for saving the still image.

6. Touch <Load>.

The File Select screen appears.

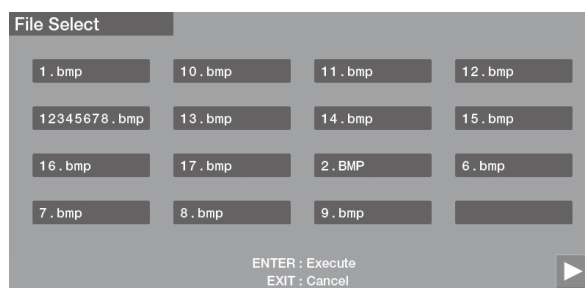

7. To select the still-image file to import, touch the name of the file.

The display changes to green.

8. To import, press the [ENTER] button.

To cancel, press the [EXIT] button.

Outputting a still image

1. At the menu screen, Touch Video <Still>.

The Video Input Still screen appears.

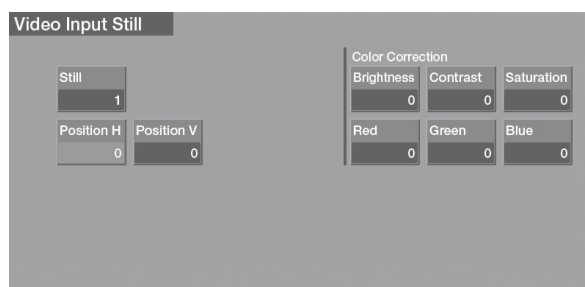

2. Touch <Still> to display the Still Select screen, then select the still image you want to output.



3. Touch the name of the file, then press the VIDEO INPUT SELECT [STILL] button, making the button's indicator light up.

The still image is output.

Outputting a User Logo

You can make the setting so that pressing the [FREEZE/USER LOGO] button stops video output and outputs a still image you want to display. This is useful when you want to output a user logo (such as company or product logo).

You import the user logo from a USB flash drive that you connect to the unit.

1. First, use the procedure in “Importing still images” (p. 35) to import a file containing the user logo.
2. At the menu screen, touch System <Setup>. The System screen appears.
3. Touch <◀> or <▶> to change to the screen where “Freeze/User Logo” is displayed.

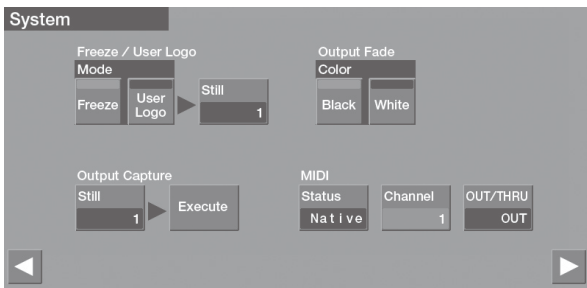

4. Touch Mode <User Logo>.
5. Touch <Still> to display the Still Select screen, then select the file containing the user logo.



6. Press the [FREEZE/USER LOGO] button, making it light up. Video output stops and the user logo is output.



Pressing the [FREEZE/USER LOGO] button once more (making the button go dark) returns the unit from user-logo output to video output.

Freezing the Output Screen

You can make the setting so that pressing the [FREEZE/USER LOGO] button freezes the output screen.

1. Display the menu screen (p. 13).
2. Touch System <Setup>. The System screen appears.
3. Touch <◀> or <▶> to change to the screen where “Freeze/User Logo” is displayed.

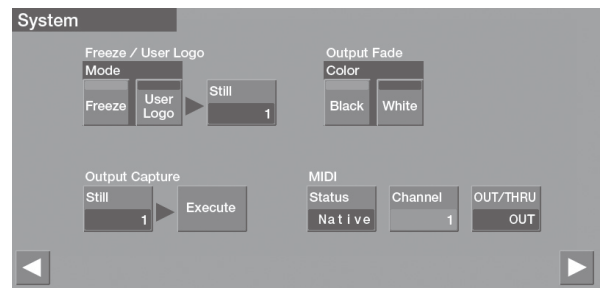

4. Touch Mode <Freeze>.
5. Press the [FREEZE/USER LOGO] button, making it light up. This freezes the video output.

Pressing the [FREEZE/USER LOGO] button once more (making the button go dark) returns the unit from the frozen state to video output.

Changing the Screen Labels

By default, labels like the one shown below are displayed at the bottom of the screen for each channel.

Example: When the MONITOR [MULTI-VIEW] button is lighted

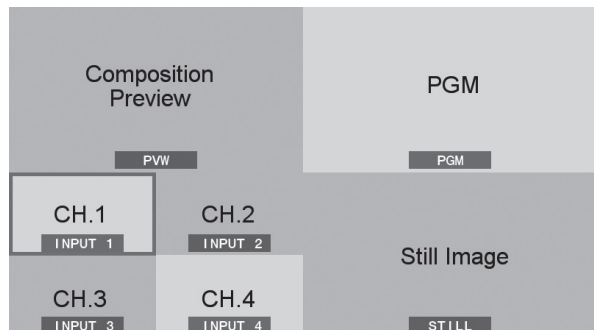

You can use the following procedure to change each channel's label to a text string you choose (up to 8 characters).

1. Display the menu screen (p. 13).
2. Touch System <Setup>. The System screen appears.
3. Touch <Left Arrow> or <Right Arrow> to switch the screen, then touch <Label>. The Label screen appears.

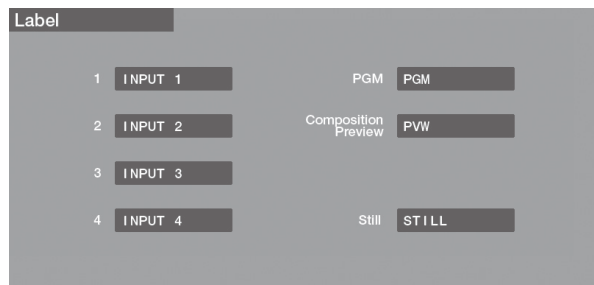

4. Touch the label you want to change to display the input screen, then enter the characters.

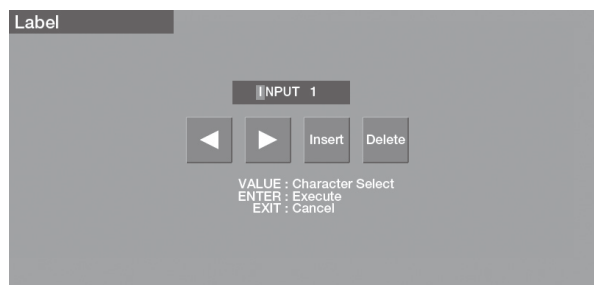

Touch <Left Arrow> or <Right Arrow> to move the cursor, and use the [VALUE] knob to select characters.

Insert	Insert a space at the cursor position.
Delete	Delete the character at the cursor position.

5. When you've finished entering the text, press the [ENTER] button to apply it. Pressing the [EXIT] button cancels text entry.

Changing the Video Output Bus

This specifies what video signals are output from the respective video output connectors.

Assigning an Output Bus to Video Connectors

1. Display the menu screen (p. 13).
2. Touch Video <Output>. The Video Output screen appears.
3. Touch <Left Arrow> or <Right Arrow> to change to the screen where "Output Bus" is displayed.

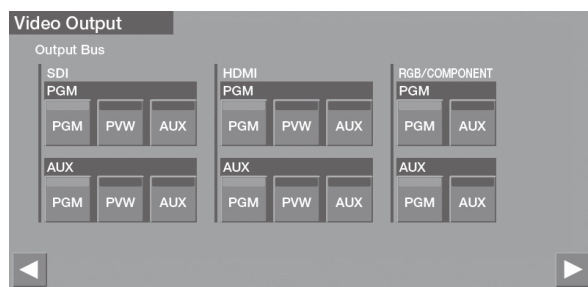

4. Select the output bus to assign to the respective output connectors by touching one of the buttons from <PGM>-<AUX>.

Value	Explanation
PGM	The PGM bus is assigned. This is the final video signal processed by the VR-50HD itself.
PVW	The PVW bus is assigned. This is a video signal allowing previewing of the results up through video compositing.
AUX	The AUX bus is assigned. This is the video signal selected using AUX Bus Source.

5. Press the [MENU] button to exit the menu screen.

Selecting the Signal of the AUX Bus

1. Display the menu screen (p. 13).

2. Touch Video <Output>.

The Video Output screen appears.

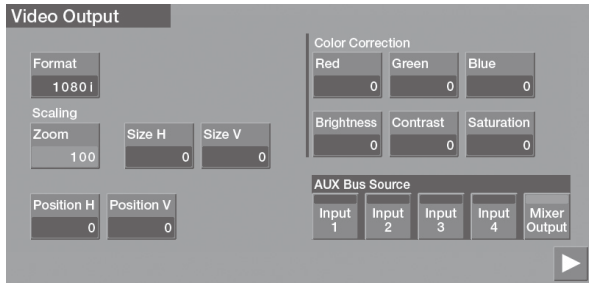

3. Touch AUX Bus Source <Input 1>–<Mixer Output> to select the signal.

Value	Explanation
Input 1–4	Video signals input via video inputs 1–4
Mixer Output	Video signal with transition effects applied

4. Press the [MENU] button to exit the menu screen.

Capturing Video Being Output

You can capture images from video as it is being output.

You can take captured video images and use them as still images for user logos or in luminance-key processing.

1. Display the menu screen (p. 13).

2. Touch System <Setup>.

The System screen appears.

3. Touch <Left Arrow> or <Right Arrow> to change to the screen where “Output Capture” is displayed.

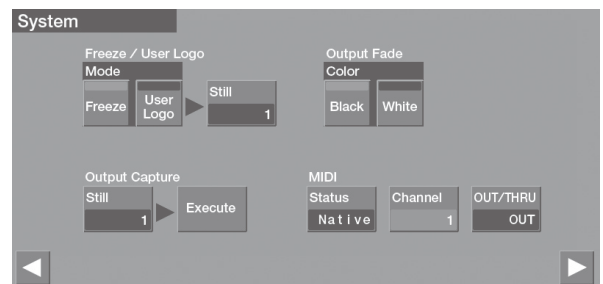

4. Touch Output Capture <Still>.

The Still Select screen appears.



5. Touch the destination for saving the captured video image.

6. Press the [EXIT] button to go back one screen.

7. Move to the video image you want to capture and touch <Execute>.

The video image is captured.

NOTE

- Sending the captured image might take some time.
- Still images on the Still Select screen which have an HDCP icon next to the file names are video images captured while HDCP is set to ON. They cannot be used when HDCP is set to OFF.
- Captured video images cannot be saved on a USB flash drive or other external media.

Saving/Recalling Settings

You can take the current settings, including the panel state, audio settings, and video settings, and save them in the unit's internal memory as a single set, then call them up for use when needed.

Saving settings

* Still images are not saved.

1. Display the menu screen (p. 13).

2. Touch System <Memory>.

The Memory screen appears.

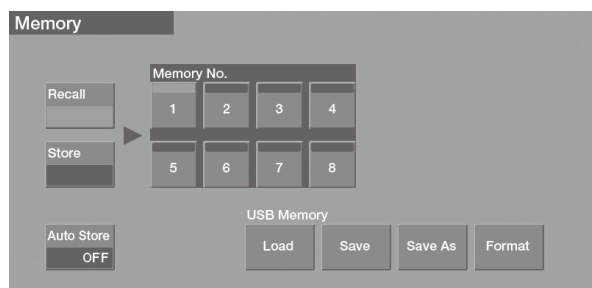

3. Touch <Store>, making it light up in red.

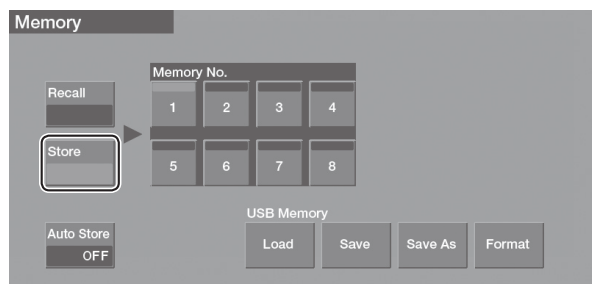

4. Touch the memory number (<1>-<8>) where you want to save the settings.

The settings are saved.

MEMO

- When Auto Store is set to ON, the settings are automatically saved at Memory No. 1 when you change the menu.
- Some parameters selected using System <Setup> (such as HDCP and Frame Rate) are not saved at separate memory numbers. Only a single set is saved in the unit. For details, refer to Reference Manual (PDF). After parameters have been set, they are automatically saved when you change the menu screen.
- A memory number for which the Memory No. text is displayed in black has never had values saved to it. Recalling such a memory number calls up default values.

Recalling settings

* The settings at Memory No. 1 are called up automatically at power-up.

1. Display the menu screen (p. 13).

2. Touch System <Memory>.

The Memory screen appears.

3. Touch <Recall>, making it light up in green.

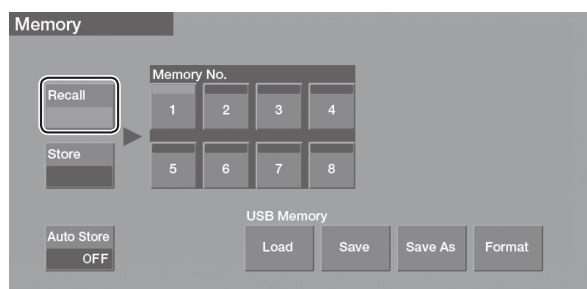

4. Touch the memory number (<1>-<8>) whose settings you want to call up.

The settings are recalled.

NOTE

Screen corruption occurs when settings are recalled

When settings in memory are recalled, corruption of the output video occurs when the input connectors are switched or the output format changes (p. 42).

Saving Settings on a USB Flash Drive/ Importing Settings from a USB Flash Drive

You can group together the settings saved at Memory No. 1–8 and the system settings, and save them on a USB flash drive as a single file.

You can also import such a file saved on a USB flash drive into the VR-50HD.

Saving settings

1. Display the menu screen (p. 13).
2. Touch **System <Memory>**.

The Memory screen appears.

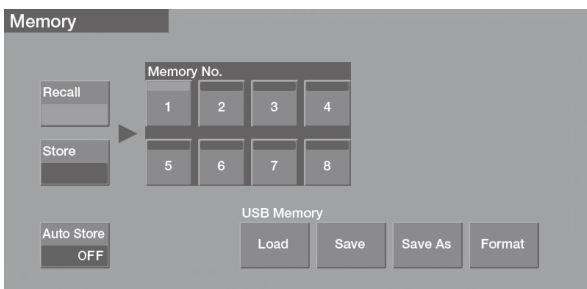

3. Touch **USB Memory <Save As>**.

To overwrite an existing file, touch <Save>.

The Save As screen appears.

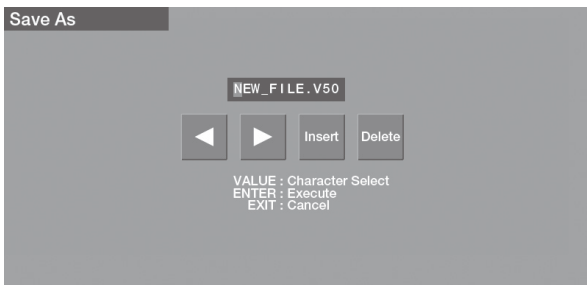

4. Enter the file name.

Touch <◀> or <▶> to move the cursor, and use the [VALUE] knob to select characters.

Insert	Insert a space at the cursor position.
Delete	Delete the character at the cursor position.

5. To carry out the saving file, press the [ENTER] button.

To cancel, press the [EXIT] button.

Importing settings

1. Display the menu screen (p. 13).
2. Touch **System <Memory>**.
3. Touch **USB Memory <Load>**.

The File Select screen appears.

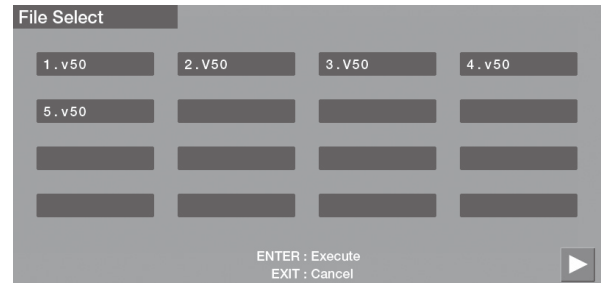

4. Touch the file you want to import.
5. To import the file, press the [ENTER] button.

To cancel, press the [EXIT] button.

Returning to the Factory-default Settings (Factory Reset)

You can return the settings on the VR-50HD to their factory-default values.

This is called a "factory reset."

NOTE

Performing a factory reset causes all user data saved in the unit to be lost. Before you perform this operation, check whether there is any data you want to keep.

1. Display the menu screen (p. 13).
2. Touch **System <Setup>**.
The System screen appears.
3. Touch **<◀>** or **<▶>** to change to the screen where "Factory Reset" is displayed.

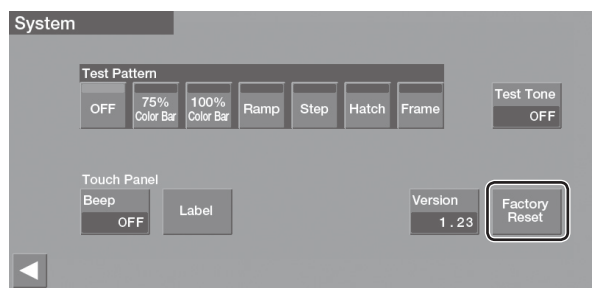

4. Touch **<Factory Reset>**.
A confirmation prompt appears.
5. To carry out the factory reset, press the [ENTER] button.
To cancel, press the [EXIT] button.

NOTE

- Be very sure never to turn off the power while "Processing." is displayed.
- Default setting of the system frame rate is 59.94 Hz.
When you want to operate in the Frame Rate of 50 Hz, you can set it at the System screen (refer to the "Reference Manual" (PDF)).

Troubleshooting

Problem	Items to check	Action	Page
Colors are incorrect	The color space of the video being input or output does not match the color space for the processing being done by the unit.	(When input or output HDMI, RGB/COMPONENT) Use the menus to change the settings for the following parameters. For details, refer to "Reference Manual" (PDF). <ul style="list-style-type: none"> Set Video Input Color Space. For Video Input, set Color Correction to its default value. For Video Output, set Color Correction to its default value. Depending on the equipment, the color-space setting may change with the selection of DVI or HDMI or the format selection. In such cases, changing the color space on the input and output equipment might correct the problem.	—
No picture is output	HDCP is set to ON.	When HDCP is set to ON, no video other than HDMI is output. Also, no output is made via the USB STREAMING connector.	p. 23
	A monitor that supports HDCP is not being used.	Check whether a monitor that supports HDCP is being used.	—
No connection can be made using USB 3.0, or the picture is jerky	The computer's driver for USB port is not up to date.	Install the updated driver.	—
	The connection is using an extension cable or USB hub.	Connect the VR-50HD and the computer directly.	p. 20
	At the USB Streaming screen, parameters are not set correctly.	Touch <Reset> in the USB Streaming screen. Lower the settings for Resolution and Frame Rate so that the Dropped Frames value reaches "0."	p. 21
A USB flash drive cannot be read	The device was not formatted on the VR-50HD.	Format the device on the VR-50HD.	p. 34
	A non-Roland USB flash drive was used.	Operation of non-Roland USB flash drives cannot be assured. Also, operation has been tested for commonly available USB flash drives, but operation with all USB flash drives is not assured. Depending on the manufacturer and type of the USB flash drive, correct operation may not be possible.	—
Composite and RGB cannot be selected as the Source setting for PinP or PinP/KEY	Selecting a different connector than the connector Specified by Input Assign was attempted.	ANALOG/HDMI 1 is dependent on the Input Assign setting for channel 1, and ANALOG/HDMI 2 is dependent on the setting for channel 2. Using Input Assign to select SDI makes it possible to choose Composite or RGB.	p. 26
No audio is output	HDCP is set to ON.	When HDCP is set to ON, output can be made only to HDCP-compatible HDMI equipment. If you are using audio only, use a separate HDCP-compatible device capable of de-embedding HDMI audio.	p. 23
The screen freezes momentarily during mode switching in video compositing	Because the buses needed for switching the video being composited are insufficient, this problem occurs when AUX Bus Source is set to a value from Video 1–Video 4 and PinP or PinP/KEY is used, and the mode is switched while a WIPE operation is in progress.	This is not a malfunction.	—
Recalling settings (Memory) results in screen corruption	When values related to the video being input and output change, video corruption can occur when the values are set.	When you want smooth switching between memory sets before and after call-up, set the values for the video output to PGM to the same settings in both memory sets.	—
HDMI output shown on a display has its periphery cut off	The display settings are not compatible.	In the case of HDMI signals, automatic overscan occurs on some displays. Change the display's settings.	—
	The HDMI output signal is not compatible.	Using the menus, go to Video Output and select DVI-D as the setting for Signal Type. For details, refer to "Reference Manual" (PDF).	p. 13
The unit gets extraordinary hot	Voltage of the external power source you are using is not within DC 12 V–16 V.	Stop using the external power source and use the included AC adaptor.	p. 12
	The cooling fan malfunction.	Immediately stop using the unit, and request servicing by your retailer, the nearest Roland Service Center, or an authorized Roland distributor, as listed on the "Information" sheet.	—

About Remote Control

The VR-50HD can be operated remotely from an external RS-232C or MIDI device.

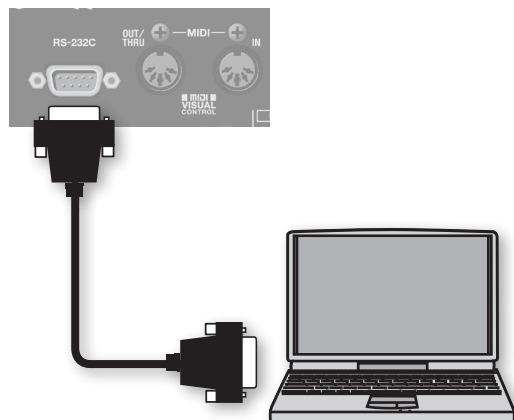

For more information about remote control, download the "Reference Manual" (PDF) from the following Roland website.

<http://www.rolandsystemsgroup.net/>

About MIDI VISUAL CONTROL

The VR-50HD can be operated remotely from a device that supports MIDI Visual Control.



MIDI Visual Control is an internationally-used recommended practice that was added to the MIDI specification so that visual expression could be linked with musical performance. Video equipment that is compatible with MIDI Visual Control can be connected to electronic musical instruments via MIDI in order to control video equipment in tandem with a performance.

Main Specifications

Roland VR-50HD: MULTI-FORMAT AV MIXER

Processing		
4: 4: 4 (RGB), 10-bit (Internal processing)		
4: 2: 2 (Y/Pb/Pr), 10-bit		
Video		
Input Connectors	3G/HD/SD-SDI	BNC type x 4 (INPUT 1–4) * Conforms to SMPTE 424M (SMPTE 425M-AB), 292M, 259M-C.
	HDMI (DVI-D)	Type A (19 pin) x 4 (INPUT 1–4) * HDCP Supported.
	Analog RGB/HD-Component	Mini D-sub 15-pin type x 2 (INPUT 1–2)
	Analog Video (SD)	Composite (BNC type) x 2 (INPUT 1–2) * INPUT 1–2: Select SDI, HDMI or Analog RGB, Composite using menu per channel.
Output Connectors	3G/HD/SD-SDI	BNC type x 2 (PGM OUT, AUX OUT) * Conforms to SMPTE 424M (SMPTE 425M-AB), 292M, 259M-C
	HDMI (DVI-D)	Type A (19 pin) x 3 (PGM OUT, AUX OUT, MULTI VIEW) * HDCP Supported.
	Analog RGB/HD-Component	Mini D-sub 15-pin type x 2 (PGM OUT, AUX OUT)
Input/Output Level and Impedance	Composite	1.0 Vp-p 75 Ω
	Analog RGB	0.7 Vp-p 75 Ω (H, V: 5 VTTL)
	Analog HD	1.0 Vp-p 75 Ω (Sync-Signal: Bi-Level/Tri-Level)
Supported Video Formats		
SDI	480/59.94i, 576/50i, 720/59.94p, 720/50p, 1080/59.94i, 1080/50i, 1080/59.94p, 1080/50p * Conforms to SMPTE 274M, SMPTE 296M, ITU-R BT.601-5.	
HDMI (*1)	480/59.94i, 576/50i, 480/59.94p, 576/50p, 720/59.94p, 720/50p, 1080/59.94i, 1080/50i, 1080/59.94p, 1080/50p, 1024 x 768/60 Hz (*2), 1280 x 720/60 Hz (*2), 1280 x 800/60 Hz (*2), 1280 x 1024/60 Hz (*2), 1400 x 1050/60 Hz, 1920 x 1080/60 Hz	
HDMI (MULTI-VIEW Output) (*1)	1080/60p	
Component (*1)	480/59.94i, 576/50i, 480/59.94p, 576/50p, 720/59.94p, 720/50p, 1080/59.94i, 1080/50i, 1080/59.94p, 1080/50p	
RGB (*1)	1024 x 768/60 Hz (*2), 1280 x 720/60 Hz, 1280 x 800/60 Hz (*2), 1280 x 1024/60 Hz (*2), 1400 x 1050/60 Hz, 1920 x 1080/60 Hz	
Composite	NTSC, PAL * Conforms to ITU-R BT.601-5.	
USB-VIDEO	480/29.97p, 576/25p, 480/59.94p, 576/50p, 720/29.97p, 720/25p, 720/59.94p, 720/50p, 1080/29.97p, 1080/25p, 1080/59.94p, 1080/50p	
Still Image	Windows Bitmap File (.bmp) * Maximum 1900 x 1080 pixels, 24-bit per pixel, uncompressed.	
*1: Conforms to CEA-861-E or VESA DMT Version 1.0 Revision 11.		
*2: Output refresh rate is 75 Hz when frame rate is set to 50 Hz.		
* The output format of HDMI and RGB/Component is always the same. When a Video format is selected, component signal is output from the RGB/COMPONENT connector. When a RGB format is selected, RGB signal is output from the RGB/COMPONENT connector.		
* The video signal frame rate must match with the unit's frame rate setting.		
Effects		
Transition	Mix, Cut, Wipe (9 patterns)	
Composition	PinP, Chrominance Key, Luminance Key	
Others	Output Fade, Output Freeze, User Logo	

Audio		
Input Connectors	AUDIO IN (1 to 4) jacks (XLR/TRS combo type) * XLR type: 1 GND, 2 HOT, 3 COLD * Phantom Power: DC 48 V (unloaded maximum), 5 mA (maximum load) (Current value per channel).	
	AUDIO IN (5 to 8) jacks (RCA phono type)	
	AUDIO IN (9 to 12) jacks (TRS Type)	
Output Connectors	AUDIO OUT L, R jacks (XLR-3-32 type) * XLR type: 1 GND, 2 HOT, 3 COLD	
	AUDIO OUT L, R jacks (RCA phono type)	
	PHONES jack (Stereo 1/4-inch phone type) (headphones)	
	PHONES jack (Stereo miniature type) (headphones)	
Input Level and Impedance	XLR/TRS	-68 to +4 dBu (Maximum: +22 dBu, 4 kΩ)
	RCA phono	-10 dBu (Maximum: +8 dBu, 11 kΩ)
	TRS	+4 dBu (Maximum: +22 dBu, 98 kΩ)
Output Level and Impedance	XLR	+4 dBu (Maximum: +22 dBu, 600 Ω)
	RCA phono	-10 dBu (Maximum: +8 dBu, 1 kΩ)
	Headphones	25 mW + 25 mW, 20 Ω
Audio Processing		
Sampling Rate	24-bit/48 kHz	
Audio Formats		
SDI	Linear PCM, 24 bit, 48 kHz, 2 ch * SMPTE 299M, SMPTE 272M-C	
HDMI	Linear PCM, 24 bit, 48 kHz, 2 ch	
USB-AUDIO	Linear PCM, 16 bit, 48 kHz, 2 ch	
Audio Effects		
Channel Effects	Compressor, Noise Gate, 3-Band EQ, Delay	
Master Effects	Mastering, 3-Band EQ, Reverb	
Other Connectors		
Remote	MIDI	5 pin DIN type (IN, OUT/THRU)
	RS-232C	D-sub 9 pin type x 1
Interface	USB 2.0 port (host)	Hi-Speed USB: Type A (for USB flash drive)
	USB 3.0 port (device)	Type B for USB-VIDEO (Super-Speed/Hi-Speed), USB-AUDIO (Full-Speed)
Display		
7 inch Graphic color LCD 800 x 480 dots (touch screen)		
Others		
Power Supply	AC Adaptor DC 24 V Secondary AC Adaptor DC 12 V to 16 V (XLR-4-32 type)	
Current Draw	2.5 A (DC 24 V)	
Dimensions	434 (W) x 293.4 (D) x 141.3 (H) mm 17-1/8 (W) x 11-9/16 (D) x 5-9/16 (H) inches	
Weight (excluding AC adaptor)	5.3 kg 11 lbs 11 oz	
Operation Temperature	+0 to +40 degrees Celsius +32 to +104 degrees Fahrenheit	
Accessories	AC adaptor, Power cord, RCA-BNC conversion plug x 2, Owner's Manual, "Information" sheet	

* 0 dBu= 0.775 Vrms

* In the interest of product improvement, the specifications and/or appearance of this unit are subject to change without prior notice.

* This product is a Class A digital device under FCC part 15.

Index

A

Audio Follow	32
AUDIO IN	17
AUDIO OUT	19
AUX	19, 37
AUX Bus	38
AUX Bus Source	38
AUX Delay	29, 30, 32

C

Capture	38
Channel Parameter	29
Chroma Key	27
COMPOSITE IN	15
COMPOSITION	26
COMPOSITION SETUP	26, 27
CUT	24

D

Delay	29, 30, 32
-------------	------------

E

Equalizer	33
External Power Source	12

F

Factory Reset	41
Follow	32
Frame Rate	21, 22
FREEZE/USER LOGO	36



H

HDCP	23
HDCP indicator	23
HDMI IN	15
HDMI OUT	19
HDMI/SDI Audio	18

I

INPUT	9
INPUT ASSIGN	16
Input Format	22

K

[KEY LEVEL ] knob	28
[KEY LEVEL ] knob	28

L

Label	37
Level Meter	31
Lip-sync	21, 32
Luminance Key	27

M

Mastering	33
Menu Screen	13
MIDI	43
MIDI Visual Control	43
MIX	24
MONITOR	24
MULTI-VIEW	9, 19

O

Output Bus	30, 37
OUTPUT FADE	25
Output Format	22

P

PGM	9, 19, 37
Phantom Power	18
Picture-in-Picture	27
PinP	26, 27
PinP/KEY	26, 27
PVW	37

R

RCA-BNC Conversion Plug	15
Resolution	21
Reverb	33
[REVERB] knob	33
RGB/COMPONENT IN	15
RGB/COMPONENT OUT	19
RS-232C	43

S

SDI IN	15
SDI OUT	19
Settings	
Recalling	39
Saving	39
SETUP	18, 29
Solo	29, 30
STILL	9
Still Image	35
STILL KEY	26
Streaming	20, 21

T

TRANSITION	24, 25
TRANSITION [TIME] knob	24, 25, 32

U

[USB AUDIO LEVEL] knob	21
USB Flash Drive	
Formatting	34
Importing Settings	40
Saving Settings	40
USB Streaming	20, 21
User Logo	36

V

Video Bus	21
Video-composition	26
VIDEO INPUT SELECT [STILL] button	35

W

WIPE	24
------------	----

For the U.K.

IMPORTANT: THE WIRES IN THIS MAINS LEAD ARE COLOURED IN ACCORDANCE WITH THE FOLLOWING CODE.

BLUE: NEUTRAL
BROWN: LIVE

As the colours of the wires in the mains lead of this apparatus may not correspond with the coloured markings identifying the terminals in your plug, proceed as follows:

The wire which is coloured BLUE must be connected to the terminal which is marked with the letter N or coloured BLACK.
The wire which is coloured BROWN must be connected to the terminal which is marked with the letter L or coloured RED.
Under no circumstances must either of the above wires be connected to the earth terminal of a three pin plug.

For the USA

FEDERAL COMMUNICATIONS COMMISSION RADIO FREQUENCY INTERFERENCE STATEMENT

This equipment has been tested and found to comply with the limits for a Class A digital device, pursuant to Part 15 of the FCC Rules. These limits are designed to provide reasonable protection against harmful interference when the equipment is operated in a commercial environment. This equipment generates, uses, and can radiate radio frequency energy and, if not installed and used in accordance with the instruction manual, may cause harmful interference to radio communications. Operation of this equipment in a residential area is likely to cause harmful interference in which case the user will be required to correct the interference at his own expense.

This device complies with Part 15 of the FCC Rules. Operation is subject to the following two conditions:

- (1) this device may not cause harmful interference, and
- (2) this device must accept any interference received, including interference that may cause undesired operation.

To assure continued FCC emission limit compliance, use only shielded interface cables when connecting to other device. Any unauthorized changes or modifications not expressly approved by the party responsible for compliance could void the user's authority to operate the equipment.

For Canada

CAN ICES-3 (A)/NMB-3 (A)

For Korea

사용자 안내문

기종별	사용자 안내문
A급 기기 (업무용 방송통신기자재)	이 기기는 업무용(A급) 전자파적합기기로서 판매자 또는 사용자는 이 점을 주의하시기 바라며, 가정외의 지역에서 사용하는 것을 목적으로 합니다.

For C.A. US (Proposition 65)

WARNING

This product contains chemicals known to cause cancer, birth defects and other reproductive harm, including lead.

For EU Countries



This product is intended for use in the following Electromagnetic environments:
E1: residential, E2: commercial and light industrial, E3: urban outdoors, E4: controlled EMC environment, ex. recording studio (broadcasting studio) which are specified in EN55103-1 and EN55103-2.

For EU Countries



- UK** This symbol indicates that in EU countries, this product must be collected separately from household waste, as defined in each region. Products bearing this symbol must not be discarded together with household waste.
- DE** Dieses Symbol bedeutet, dass dieses Produkt in EU-Ländern getrennt vom Hausmüll gesammelt werden muss gemäß den regionalen Bestimmungen. Mit diesem Symbol gekennzeichnete Produkte dürfen nicht zusammen mit dem Hausmüll entsorgt werden.
- FR** Ce symbole indique que dans les pays de l'Union européenne, ce produit doit être collecté séparément des ordures ménagères selon les directives en vigueur dans chacun de ces pays. Les produits portant ce symbole ne doivent pas être mis au rebut avec les ordures ménagères.
- IT** Questo simbolo indica che nei paesi della Comunità europea questo prodotto deve essere smaltito separatamente dai normali rifiuti domestici, secondo la legislazione in vigore in ciascun paese. I prodotti che riportano questo simbolo non devono essere smaltiti insieme ai rifiuti domestici. Ai sensi dell'art. 13 del D.Lgs. 25 luglio 2005 n. 151.
- ES** Este símbolo indica que en los países de la Unión Europea este producto debe recogerse aparte de los residuos domésticos, tal como esté regulado en cada zona. Los productos con este símbolo no se deben depositar con los residuos domésticos.
- PT** Este símbolo indica que nos países da UE, a recolha deste produto deverá ser feita separadamente do lixo doméstico, de acordo com os regulamentos de cada região. Os produtos que apresentem este símbolo não deverão ser eliminados juntamente com o lixo doméstico.
- NL** Dit symbool geeft aan dat in landen van de EU dit product gescheiden van huishoudelijk afval moet worden aangeboden, zoals bepaald per gemeente of regio. Producten die van dit symbool zijn voorzien, mogen niet samen met huishoudelijk afval worden verwijderd.
- DK** Dette symbol angiver, at i EU-lande skal dette produkt opsamles adskilt fra husholdningsaffald, som defineret i hver enkelt region. Produkter med dette symbol må ikke smides ud sammen med husholdningsaffald.
- NO** Dette symbolet indikerer at produktet må behandles som spesialavfall i EU-land, iht. til retningslinjer for den enkelte regionen, og ikke kastes sammen med vanlig husholdningsavfall. Produkter som er merket med dette symbolet, må ikke kastes sammen med vanlig husholdningsavfall.

- SE** Symbolen anger att i EU-länder måste den här produkten kasseras separat från hushållsavfall, i enlighet med varje regions bestämmelser. Produkter med den här symbolen får inte kasseras tillsammans med hushållsavfall.
- FI** Tämä merkintä ilmaisee, että tuote on EU-maissa kerättävä erillään kotitalousjätteistä kunkin alueen voimassa olevien määräysten mukaisesti. Tällä merkinnällä varustettuja tuotteita ei saa hävittää kotitalousjätteiden mukana.
- HU** Ez a szimbólum azt jelenti, hogy az Európai Unióban ezt a terméket a háztartási hulladéktól elkülönítve, az adott régióban érvényes szabályozás szerint kell gyűjteni. Az ezzel a szimbólummal ellátott termékeket nem szabad a háztartási hulladék közé dobni.
- PL** Symbol oznacza, że zgodnie z regulacjami w odpowiednim regionie, w krajach UE produktu nie należy wyrzucać z odpadami domowymi. Produktów opatrzonych tym symbolem nie można utylizować razem z odpadami domowymi.
- CZ** Tento symbol udává, že v zemích EU musí být tento výrobek sbírán odděleně od domácího odpadu, jak je určeno pro každý region. Výrobky nesoucí tento symbol se nesmí vyhazovat spolu s domácím odpadem.
- SK** Tento symbol vyjadruje, že v krajinách EÚ sa musí zber tohto produktu vykonávať oddelene od domového odpadu, podľa nariadení platných v konkrétnej krajine. Produkty s týmto symbolom sa nesmú vyhazovať spolu s domovým odpadom.
- EE** See sümbol näitab, et EL-i maades tuleb see toode olemprügist eraldi koguda, nii nagu on igas piirkonnas määratletud. Selle sümboliga märgitud tooteid ei tohi ära visata koos olmeprügiga.
- LT** Šis simbolis rodo, kad ES šalyse šis produktas turi būti surenkamas atskirai nuo buitinių atliekų, kaip nustatyta kiekviename regione. Šiuo simboliu paženklinėti produktai neturi būti išmetami kartu su buitinių atliekomis.
- LV** Šis simbols norāda, ka ES valstīs šo produktu jāievāc atsevišķi no mājsaimniecības atkritumiem, kā noteikts katrā reģionā. Produkts ar šo simbolu nedrīkst izmest kopā ar mājsaimniecības atkritumiem.
- SI** Ta simbol označuje, da je treba proizvod v državah EU zbirati ločeno od gospodinjjskih odpadkov, tako kot je določeno v vsaki regiji. Proizvoda s tem znakom ni dovoljeno odlagati skupaj z gospodinjjskimi odpadki.
- GR** Το σύμβολο αυτό υποδηλώνει ότι στις χώρες της Ε.Ε. το συγκεκριμένο προϊόν πρέπει να συλλέγεται χωριστά από τα υπόλοιπα οικιακά απορρίμματα, σύμφωνα με όσα προβλέπονται σε κάθε περιοχή. Τα προϊόντα που φέρουν το συγκεκριμένο σύμβολο δεν πρέπει να απορρίπτονται μαζί με τα οικιακά απορρίμματα.

For China

有关产品中所含有害物质的说明

本资料就本公司产品中所含的特定有害物质及其安全性予以说明。
本资料适用于 2007 年 3 月 1 日以后本公司所制造的产品。

环保使用期限



此标志适用于在中国国内销售的电子信息产品，表示环保使用期限的年数。所谓环保使用期限是指在自制造日起的规定的期限内，产品中所含的有害物质不致引起环境污染，不会对人身、财产造成严重的不良影响。环保使用期限仅在遵照产品使用说明书，正确使用产品的条件下才有效。不当的使用，将会导致有害物质泄漏的危险。

产品中有毒有害物质或元素的名称及含量

部件名称	有毒有害物质或元素					
	铅(Pb)	汞(Hg)	镉(Cd)	六价铬(Cr(VI))	多溴联苯(PBB)	多溴二苯醚(PBDE)
外壳(壳体)	×	○	○	○	○	○
电子部件(印刷电路板等)	×	○	×	○	○	○
附件(电源线、交流适配器等)	×	○	○	○	○	○

○：表示该有毒有害物质在该部件所有均质材料中的含量均在 SJ/T11363-2006 标准规定的限量要求以下。
×：表示该有毒有害物质至少在该部件的某一均质材料中的含量超出 SJ/T11363-2006 标准规定的限量要求。
因根据现有的技术水平，还没有什么物质能够代替它。

