



STAIRVILLE

AF-250 DMX
fog machine

Musikhaus Thomann
Thomann GmbH
Hans-Thomann-Straße 1
96138 Burgebrach
Germany
Telephone: +49 (0) 9546 9223-0
E-mail: info@thomann.de
Internet: www.thomann.de

30.08.2019, ID: 340945 (V5)

Table of contents

1	General information	5
	1.1 Further information.....	6
	1.2 Notational conventions.....	7
	1.3 Symbols and signal words.....	8
2	Safety instructions	11
3	Features	22
4	Installation	23
5	Starting up	24
6	Connections and operating elements	26
7	Operating	33
	7.1 Remote control functions.....	35
	7.2 DMX control.....	36
8	Technical specifications	37
9	Plug and connection assignments	40

10	Troubleshooting.....	41
11	Cleaning.....	43
12	Protecting the environment.....	45

1 General information

This user manual contains important information on the safe operation of the device. Read and follow all safety notes and all instructions. Save this manual for future reference. Make sure that it is available to all persons using this device. If you sell the device to another user, be sure that they also receive this manual.

Our products and user manuals are subject to a process of continuous development. We therefore reserve the right to make changes without notice. Please refer to the latest version of the user manual which is ready for download under www.thomann.de.

1.1 Further information

On our website (www.thomann.de) you will find lots of further information and details on the following points:

Download	This manual is also available as PDF file for you to download.
Keyword search	Use the search function in the electronic version to find the topics of interest for you quickly.
Online guides	Our online guides provide detailed information on technical basics and terms.
Personal consultation	For personal consultation please contact our technical hotline.
Service	If you have any problems with the device the customer service will gladly assist you.

1.2 Notational conventions

This manual uses the following notational conventions:

Letterings

The letterings for connectors and controls are marked by square brackets and italics.

Examples: *[VOLUME]* control, *[Mono]* button.

Displays

Texts and values displayed on the device are marked by quotation marks and italics.

Examples: *'24ch'*, *'OFF'*.

Instructions

The individual steps of an instruction are numbered consecutively. The result of a step is indented and highlighted by an arrow.





Example:

1. ▶ Switch on the device.
2. ▶ Press *[Auto]*.
 - ⇒ Automatic operation is started.
3. ▶ Switch off the device.

1.3 Symbols and signal words

In this section you will find an overview of the meaning of symbols and signal words that are used in this manual.

Signal word	Meaning
DANGER!	This combination of symbol and signal word indicates an immediate dangerous situation that will result in death or serious injury if it is not avoided.
WARNING!	This combination of symbol and signal word indicates a possible dangerous situation that can result in death or serious injury if it is not avoided.
CAUTION!	This combination of symbol and signal word indicates a possible dangerous situation that can result in minor injury if it is not avoided.
NOTICE!	This combination of symbol and signal word indicates a possible dangerous situation that can result in material and environmental damage if it is not avoided.
Warning signs	Type of danger
	Warning – high-voltage.

Warning signs	Type of danger
	Warning – flammable substances.
	Warning – hot surface.
	Warning - slip hazard.
	Warning – harmful or irritating substances.
	Warning – danger zone.

2 Safety instructions

Intended use

This device is intended to be used to produce artificial fog by vaporising fog fluid. Use the device only as described in this user manual. Any other use or use under other operating conditions is considered to be improper and may result in personal injury or property damage. No liability will be assumed for damages resulting from improper use.

This device may be used only by persons with sufficient physical, sensorial, and intellectual abilities and having corresponding knowledge and experience. Other persons may use this device only if they are supervised or instructed by a person who is responsible for their safety.

Safety



DANGER!

Danger for children

Ensure that plastic bags, packaging, etc. are disposed of properly and are not within reach of babies and young children. Choking hazard!

Ensure that children do not detach any small parts (e.g. knobs or the like) from the unit. They could swallow the pieces and choke!

Never let children unattended use electrical devices.



DANGER!

Electric shock caused by high voltages inside

Within the device there are areas where high voltages may be present. Never remove any covers.

There are no user-serviceable parts inside.

Do not use the device if covers, protectors or optical components are missing or damaged.



DANGER!

Electric shock caused by short-circuit

Do not modify the mains cable or the plug. Failure to do so could result in electric shock/death or fire. If in doubt, seek advice from a registered electrician.



WARNING!

Risk of burns from flammable liquids

The use of flammable liquids in this device may cause severe burns and damage to property.

Always use approved fog fluids. Never fill flammable liquids into the tank of the device.



WARNING!

Risk of burns

The generated fog at the fog nozzle is hot and can cause burns. Occasionally hot fluid drops may escape from the nozzle.

The distance of persons and objects to the fog nozzle must be at least fifty centimetre (1.6 feet).

Do not touch the fog nozzle during and shortly after operation. It becomes very hot and may cause burns even several hours after switching off the device.



WARNING!

Risk of slipping caused by condensate

Fog machines can produce condensate. Do not direct the fog to floors. Floors and surfaces can become slippery by condensed fog.

Check regularly that all floors can be accessed without slipping hazard and remove any condensate, if necessary.



WARNING!

Health hazard caused by fog fluid handling

Fog fluid does contain glycols complying with the regulations for foodstuffs. However, it may be harmful if swallowed.

Do not induce vomiting. Seek medical advice immediately. Keep fog fluid in a safe place. If the fog fluid comes into contact with eyes rinse thoroughly with water.



CAUTION!

Possible respiratory problems

The device can be operated safely only with the approved fog fluid. The use of other fluids can release toxic gases. Claims for damages caused by the use of non-approved fluids shall be excluded.

Do not create fog in closed or poorly ventilated areas.

Do not expose persons with health problems (such as allergic respiratory conditions, asthma) to artificial fog.



NOTICE!

Risk of fire

Do not block areas of ventilation. Do not install the device near any direct heat source. Keep the device away from naked flames.



NOTICE!

Operating conditions

This device has been designed for indoor use only. To prevent damage, never expose the device to any liquid or moisture. Avoid direct sunlight, heavy dirt, and strong vibrations.

Only operate the device within the ambient conditions specified in the chapter 'Technical specifications' of this user manual. Avoid heavy temperature fluctuations and do not switch the device on immediately after it was exposed to temperature fluctuations (for example after transport at low outside temperatures).

Dust and dirt inside can damage the unit. When operated in harmful ambient conditions (dust, smoke, nicotine, fog, etc.), the unit should be maintained by qualified service personnel at regular intervals to prevent overheating and other malfunction.



NOTICE!

Power supply

Before connecting the device, ensure that the input voltage (AC outlet) matches the voltage rating of the device and that the AC outlet is protected by a residual current circuit breaker. Failure to do so could result in damage to the device and possibly injure the user.

Unplug the device before electrical storms occur and when it is unused for long periods of time to reduce the risk of electric shock or fire.



NOTICE!

Possible damage due to installation of a wrong fuse

The use of different types of fuses can cause serious damage to the unit. Fire hazard!

Only fuses of the same type may be used.



NOTICE!

Possible staining

The plasticiser contained in the rubber feet of this product may possibly react with the coating of your parquet, linoleum, laminate or PVC floor and after some time cause permanent dark stains.

In case of doubt, do not put the rubber feet directly on the floor, but use felt-pad floor protectors or a carpet.

General information about how to safely operate fog machines and hazers

The device was designed for use in professional event technology and works reliably when used properly. Observe the following information:

- Follow all warnings in these operating instructions.
- Never leave the device running without supervision.
- The device is not suitable for use in private households or as a child's toy.
- Place the device on a stable, fire-proof basis that is at least twice as large as the device.
- Maintain a safety distance of 1 m to flammable materials.
- The device is not intended for suspended assembly (the so-called "flying operation").

- During operation, ensure that the visibility in the room does not fall below 2 m so that everyone in the room can still orient themselves safely.
- The haze or mist generated by the device may trigger smoke alarms.

3 Features

This fog machine is suitable for use in clubs, bars, discotheques and on stages.

Special features of the device:

- Superior performance by highly efficient heating element
- Control via DMX (one channel) or via the supplied remote control
- Suitable for mobile use due to compact design
- Bracket included

4 Installation

Unpack and check carefully there is no transportation damage before using the unit. Keep the equipment packaging. To fully protect the product against vibration, dust and moisture during transportation or storage use the original packaging or your own packaging material suitable for transport or storage, respectively.

Place the device on a stable, fire-proof basis that is at least twice as large as the device. The device requires 20 cm clearance at the sides and above. The unit should be installed horizontally, a maximum deviation of 15° is allowed.

5 Starting up

Create all connections while the device is off. Use the shortest possible high-quality cables for all connections. Take care when running the cables to prevent tripping hazards.



NOTICE!

Possible data transmission errors

For error-free operation make use of dedicated DMX cables and do not use ordinary microphone cables.

Never connect the DMX input or output to audio devices such as mixers or amplifiers.

Connections in DMX mode

Connect the DMX input of the device to the DMX output of a DMX controller or another DMX device. Connect the output of the first DMX device to the input of the second one, and so on to form a daisy chain. Always ensure that the output of the last DMX device in the daisy chain is terminated with a resistor ($110\ \Omega$, $\frac{1}{4}\ \text{W}$).

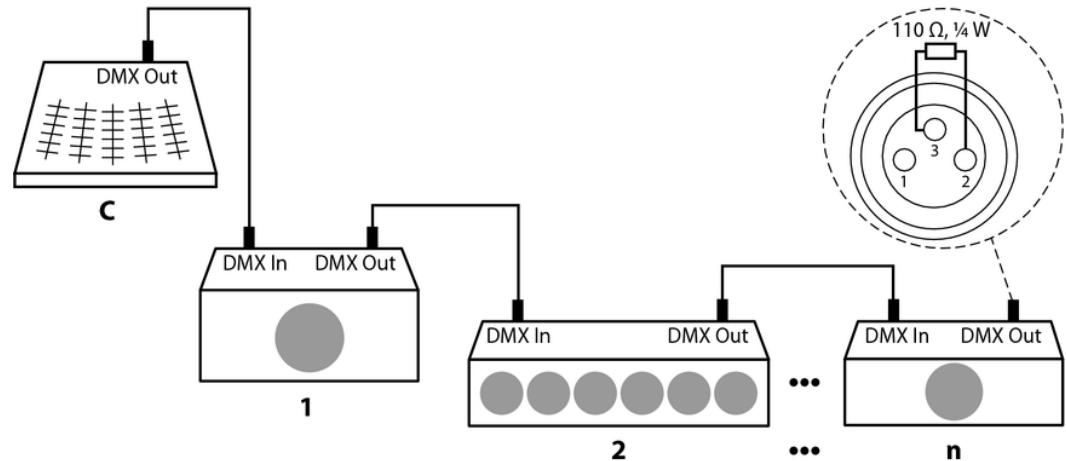

6 Connections and operating elements

Front panel

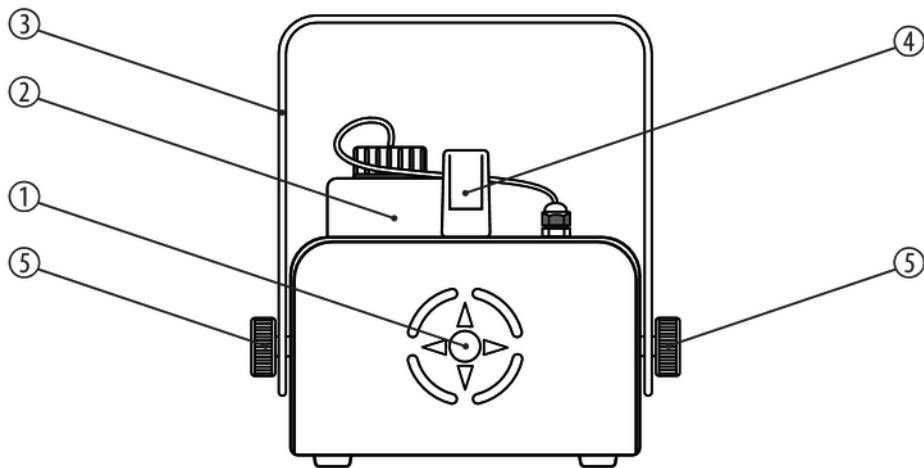

1	Fog nozzle
2	Fog fluid container with screw-cap
3	Bracket
4	Carrying handle
5	Locking screws for the bracket

Rear panel

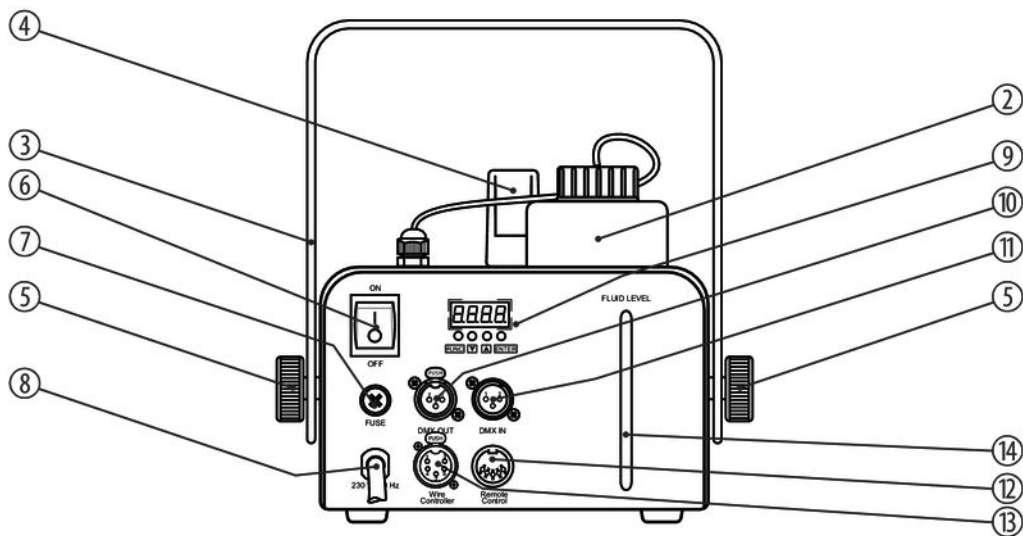

2	Fog fluid container with screw-cap
3	Bracket
4	Carrying handle
5	Locking screws for the bracket
6	Main switch. Turns the device on and off.
7	<i>[FUSE]</i> Fuse holder
8	Mains cable for power supply
9	Display with control buttons:
	<i>[ENTER]</i> Button to select a menu option and to confirm the entered values
	▲ Button to page down in the menu system, and to increase the displayed value

	▼ Button to page up in the menu system, and to decrease the displayed value
	<i>[FUNC]</i> Button to open the menu control
10	<i>[DMX OUT]</i> DMX output
11	<i>[DMX IN]</i> DMX input
12	<i>[Remote Control]</i> Connection for the receiver of the wireless remote control
13	<i>[Wire Controller]</i> Connection for the wired remote control
14	Liquid level indicator.

Remote control

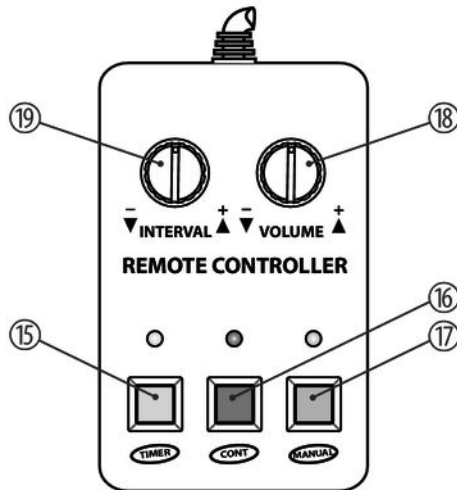

AF-250 DMX

15	<i>[TIMER]</i> With this button, you can turn the Timer function on or off. In this mode, the set amount of haze / air is output in certain intervals. The corresponding LED lights while the function is enabled.
16	<i>[CONT]</i> Press this button to turn continuous operation on or off. In this mode, the set amount of haze / air is output continuously. The corresponding LED lights while the function is enabled.
17	<i>[MANUAL]</i> Press this button to eject the maximum haze amount; set the air amount with <i>[DURATION]</i> . The corresponding LED lights while the function is enabled.
18	<i>[VOLUME]</i> Rotary control to set the amount of haze to be output
19	<i>[INTERVAL]</i> Rotary control to set the interval between two haze blasts

7 Operating

Filling the unit

**NOTICE!****Possible damages caused by unsuitable fog fluid**

Fog fluids not approved by the manufacturer may permanently damage the unit.

Exclusively use the fog fluids specified in chapter 'Technical specifications' of this manual and follow its instructions for use.

First, make sure the unit is disconnected from the mains.

Open the screw-cap of the liquid container and fill in the fog fluid. Make sure that no fog fluid is spilled or gets into the device. The easiest way is using a funnel. The container capacity is 1.9 litre.

Screw the cap firmly back on.

Turning the unit on



NOTICE!

Fire hazard

Do not operate the machine unattended.

Make sure that the remote control is connected.

Connect the device to the mains power grid and turn it on with the main switch. During heating, the display shows the value 'UP'.

As soon as the required operating temperature is reached, the green LED on the remote lights up and the display shows the set DMX address. The device is now operational.

Operation

Operation with an empty fluid container can lead to overheating and permanent damage of the pump. When operating, always ensure that there is sufficient fog fluid in the liquid container to avoid no-load running.

Turning the unit off

Disconnect the device from the mains. Transport the device only when it is completely cooled down. To avoid leaking fog fluid during transport, you should transport the device only with empty fluid container.

7.1 Remote control functions

When the device is not controlled by DMX, it supports the following operating modes that can be selected with the remote control:

- Manual operation with maximum fog
Press the pushbutton *[MANUAL]*. This mode takes precedence over all others. This means that you don't have to stop the timer function and continuous operation before you press the button.
- Continuous operation with adjustable amount of fog
In this mode, the amount of fog you have set with the *[VOLUME]* control is continuously emitted. Press the *[CONT]* switch to turn the operating mode on or off.
- Timer-controlled operation with adjustable amount of fog
In this mode, the amount of fog you have set with the *[VOLUME]* control is emitted at regular intervals (adjustable with the *[INTERVAL]* control). Press the *[TIMER]* switch to turn the operating mode on or off. The yellow LED indicates that the Timer function is enabled. Each fog burst lasts about three seconds.

7.2 DMX control

DMX address assignment

Turn the unit on as described above. Use the arrow buttons ▼ and ▲ to set the desired DMX address in the range of 1 ... 512. Confirm your selection with [ENTER]. You can then control the device with a connected controller.

DMX assignment

Channel	Value	Function
1		Setting the fog volume
	0...255	No fog output (0 %) to maximum fog output (100 %)

8 Technical specifications

Approved fog fluids	Stairville FAST-FOG (item no. 209054)	
	Stairville E-M fluid (item no. 121307)	
	Stairville E fluid (item no. 105454)	
	Stairville E-C fluid (item no. 105455)	
	Stairville E-HD heavy fluid (item no. 105456)	
Heater power	1300 W	
Warm-up time	approx. 5 min	
Fluid container capacity	1.9 l	
Fluid consumption	approx. 86 ml / min	
Fog burst capacity	approx. 180 m ³ /min	
Fog burst reach	approx. 4 ... 5 m	
Input connections	DMX control	XLR chassis socket, 3-pin

Technical specifications

	Receiver of the wireless remote control	DIN socket, 5-pin
	Wired remote control	XLR chassis socket, 5-pin
Output connections	DMX control	XLR chassis socket, 3-pin
Power consumption	1300 W	
Supply voltage	AC 230 V ~ , 50 Hz	
Fuse	5 mm × 20 mm, 8 A, 250 V, fast-acting	
Degree of protection	IP20	
Dimensions (W × H × D)	310 mm × 190 mm × 430 mm	
Weight	7.1 kg	
Ambient conditions	Temperature range	0 °C...40 °C
	Relative humidity	50 %, non-condensing

Further information

DMX control	Yes
Blast direction	Horizontal
Timer remote control	Yes
On/Off remote control	No
Radio remote control	No
Light effect	No
With suspension bracket	Yes

9 Plug and connection assignments

Introduction

This chapter will help you select the right cables and plugs to connect your valuable equipment so that a perfect light experience is guaranteed.

Please take our tips, because especially in 'Sound & Light' caution is indicated: Even if a plug fits into a socket, the result of an incorrect connection may be a destroyed DMX controller, a short circuit or 'just' a not working light show!

DMX connections

The unit offers a 3-pin XLR socket for DMX output and a 3-pin XLR plug for DMX input. Please refer to the drawing and table below for the pin assignment of a suitable XLR plug.



Pin	Configuration
1	Ground, shielding
2	Signal inverted (DMX-, 'cold signal')
3	Signal (DMX+, 'hot signal')

10 Troubleshooting

In the following we list a few common problems that may occur during operation. We give you some suggestions for easy troubleshooting:

Symptom	Remedy
The unit does not work	Check the mains connection and the main fuse.
No haze output	<ol style="list-style-type: none"> 1. Check the fluid level in the fog container. 2. Switch the device off and check the hose that leads into the fluid container for flow.
No response to the DMX controller	<ol style="list-style-type: none"> 1. Check the address settings and the DMX polarity. 2. Try to use another DMX controller. 3. Check whether the DMX cables run near or parallel to high-voltage cables that may cause damage or interference to a DMX interface circuit.
The display shows 'hiGh'.	Please send the device to our Service Center for inspection.

If the procedures recommended above do not succeed, please contact our Service Center. You can find the contact information at www.thomann.de.

11 Cleaning



NOTICE!

Possible damages caused by unsuitable cleaning agents

Cleaners not approved by the manufacturer may permanently damage the unit.

Only use the fog machine cleaners listed on www.thomann.de and follow their instructions for use.

Clean the appliance after every 30 operating hours, or if it was not in use for a longer period of time.

Procedure

1. ➤ Make sure that the device is turned off, disconnected from the mains and completely cooled down.
2. ➤ Position the unit in a well ventilated place.

3. ▶ Insert the suction hose of the fog machine into the bottle with the fog machine cleaner.
4. ▶ Connect the device to the mains power grid and turn it on with the main switch.
5. ▶ Wait until the unit has reached the required operating temperature.
6. ▶ Change to continuous operation and let the device produce fog for about 20 seconds.
7. ▶ Insert the suction hose of the fog machine back into the fog fluid container and let the device again produce fog for about 20 seconds. This will rinse the lines.
 - ⇒ The cleaning is completed.

Fan grids

The fan grids of the device must be cleaned of any contamination, such as dust, etc. on a regular basis. Before cleaning, switch off the device and disconnect mains-operated devices from the mains. Only use pH-neutral, solvent-free and non-abrasive cleaning agents. Clean the unit with a slightly damp lint-free cloth.

12 Protecting the environment

Disposal of the packaging material



For the transport and protective packaging, environmentally friendly materials have been chosen that can be supplied to normal recycling.

Ensure that plastic bags, packaging, etc. are properly disposed of.

Do not just dispose of these materials with your normal household waste, but make sure that they are collected for recycling. Please follow the notes and markings on the packaging.

Disposal of your old device



This product is subject to the European Waste Electrical and Electronic Equipment Directive (WEEE) in its currently valid version. Do not dispose with your normal household waste.

Dispose of this device through an approved waste disposal firm or through your local waste facility. When discarding the device, comply with the rules and regulations that apply in your country. If in doubt, consult your local waste disposal facility.



