

DRAWMER

1973



Three-Band Stereo FET Compressor

OPERATOR'S MANUAL

CONTENTS

Warranty	2
Safety Consideration	2
<i>Chapter 1 - Introduction</i>	
Introduction	3
Installation	4
Power Connection	4
Audio Connections	5
<i>Chapter 2 - Control Description</i>	
Control Description	6
Quick Setup Procedure	9
<i>Chapter 3 - General Information</i>	
If a fault develops	10
Contacting Drawmer	10
Specification	10
Block Diagram	11
Recall Sheet	12

COPYRIGHT

This manual is copyrighted © 2014 by Drawmer Electronics Ltd. With all rights reserved. Under copyright laws, no part of this publication may be reproduced, transmitted, stored in a retrieval system or translated into any language in any form by any means, mechanical, optical, electronic, recording, or otherwise, without the written permission of Drawmer Electronics Ltd.

ONE YEAR LIMITED WARRANTY

Drawmer Electronics Ltd., warrants the Drawmer 1973 Three-Band Stereo FET Compressor to conform substantially to the specifications of this manual for a period of one year from the original date of purchase when used in accordance with the specifications detailed in this manual. In the case of a valid warranty claim, your sole and exclusive remedy and Drawmer's entire liability under any theory of liability will be to, at Drawmer's discretion, repair or replace the product without charge, or, if not possible, to refund the purchase price to you. This warranty is not transferable. It applies only to the original purchaser of the product.

For warranty service please call your local Drawmer dealer. Alternatively call Drawmer Electronics Ltd. at +44 (0)1709 527574. Then ship the defective product, with transportation and insurance charges prepaid, to Drawmer Electronics Ltd., Coleman Street, Parkgate, Rotherham, S62 6EL UK. Write the RA number in large letters in a prominent position on the shipping box. Enclose your name, address, telephone number, copy of the original sales invoice and a detailed description of the problem. Drawmer will not accept responsibility for loss or damage during transit.

This warranty is void if the product has been damaged by misuse, modification or unauthorised repair.

THIS WARRANTY IS IN LIEU OF ALL WARRANTIES, WHETHER ORAL OR WRITTEN, EXPRESSED, IMPLIED OR STATUTORY. DRAWMER MAKES NO OTHER WARRANTY EITHER EXPRESS OR IMPLIED, INCLUDING, WITHOUT LIMITATION, ANY IMPLIED WARRANTIES OF MERCHANTABILITY, FITNESS FOR A PARTICULAR PURPOSE, OR NON-INFRINGEMENT. PURCHASER'S SOLE AND EXCLUSIVE REMEDY UNDER THIS WARRANTY SHALL BE REPAIR OR REPLACEMENT AS SPECIFIED HEREIN.

IN NO EVENT WILL DRAWMER ELECTRONICS LTD. BE LIABLE FOR ANY DIRECT, INDIRECT, SPECIAL, INCIDENTAL OR CONSEQUENTIAL DAMAGES RESULTING FROM ANY DEFECT IN THE PRODUCT, INCLUDING LOST PROFITS, DAMAGE TO PROPERTY, AND, TO THE EXTENT PERMITTED BY LAW, DAMAGE FOR PERSONAL INJURY, EVEN IF DRAWMER HAS BEEN ADVISED OF THE POSSIBILITY OF SUCH DAMAGES.

Some states and specific countries do not allow the exclusion of implied warranties or limitations on how long an implied warranty may last, so the above limitations may not apply to you. This warranty gives you specific legal rights. You may have additional rights that vary from state to state, and country to country.

DRAWMER

1973

Three-Band Stereo FET Compressor

SAFETY CONSIDERATIONS

CAUTION - MAINS FUSE

TO REDUCE THE RISK OF FIRE
REPLACE THE MAINS FUSE ONLY WITH
A FUSE THAT **CONFORMS TO IEC127-2.**
250 VOLT WORKING, TIME DELAY TYPE
AND BODY SIZE OF 20mm x 5mm.
THE MAINS INPUT FUSE MUST BE
RATED AT 230V=T250mA and 115V=T500mA.

CAUTION - MAINS CABLE

DO NOT ATTEMPT TO CHANGE
OR TAMPER WITH THE
SUPPLIED MAINS CABLE.

CAUTION - SERVICING

DO NOT PERFORM ANY SERVICING.
REFER ALL SERVICING TO QUALIFIED
SERVICE PERSONNEL.

WARNING

TO REDUCE THE RISK OF FIRE OR
ELECTRIC SHOCK DO NOT EXPOSE
THIS EQUIPMENT TO RAIN OR MOISTURE.



In the interests of product development, Drawmer reserve the right to modify or improve specifications of this product at any time, without prior notice.

DRAWMER 1973

THREE-BAND STEREO FET COMPRESSOR



INTRODUCTION

The 1973 is a Three Band Compressor with the versatility, control and ability to shape sound that no full band compressor could ever provide and at an affordable price.

Expanding on the renowned range of dynamics processors *DRAWMER* introduce an affordable Three Band Stereo FET Compressor that every engineer will completely appreciate - the **1973**. The culmination of 30 years of development and experience, the 1973 combines the functionality and control of the world class *DRAWMER* S3 with the familiarity and quality of the illustrious 1960 and 1968, providing three bands of transparent, intuitive compression for the price of a conventional single full band compressor.

How does the 1973 differ from a full band compressor? In essence, the 1973 comprises a set of crossover filters that splits the audio signal into three frequency bands, each split signal then passes through its own compressor and is independently adjusted, after which the signals are recombined and the final Wet/Dry mix and levels can be adjusted. The advantage is that one band's compression has no affect on the others.

What's so good about a three band compressor anyway? The 1973 can pull off amazing feats that a single-band compressor could never accomplish. For example, it can easily prevent an acoustic guitar, cello, or double bass from sounding boomy on low notes without thinning the highs.

Are you recording a vocal track that sounds too shrill? The timbre can easily be altered without eliminating detail and clarity. Adding heavier compression in the bass band can add to the thickness and richness of the voice, in the mid band raspiness is controlled, whilst compression to the high band can give sizzle and definition to an otherwise bland voice. In addition, sibilance can easily be tamed.

In a mastering situation, having independent control over each band can resolve a problem mix, pulling out individual instruments, brighten the brilliance/air or make the bottom

end of a mix sound huge whilst simultaneously avoid "pumping" or "breathing" artifacts and increase headroom.

Multiband compressors can be intimidating and difficult to use due to a minefield of controls and poor lay out, with this in mind, the 1973 has been designed to be as simple, familiar and intuitive as possible whilst still giving complete control over the audio.

Main Features:

Standard intuitive controls such as Threshold, Gain, Switched Attack & Release with Gain Reduction Metering on Each Band.

Fast Reacting Soft Knee F.E.T. Design with excellent Left/Right Tracking across the Full Range of compression.

Variable Wet/Dry Mix plus Output Gain Knobs give a 'Parallel Compression' function without the need for external mixing devices, providing Complete and Effortless Control over the amount of compression used and Output Levels.

Variable Band Split Filters at a 6dB Per Octave slope with Switch-able Mute and Bypass on Each Band make 'Tuning In' to a Frequency Simple.

'Big' and 'Air' Modes Help to preserve the Very Deep Lows and Enhance the Sparkling Highs.

Two Analogue V.U. Meters with Switchable +10dB Meter Rescale Modes and a Switchable 'Peak' mode to Display Fast Transients Not Normally Seen on Conventional V.U.s.

Internal Low Hum Toroidal Linear Power Supply with Voltage Selector Switch

Classic Drawmer Build Quality with Rugged Steel Chassis and Aluminium Front Panel.

INSTALLATION

The 1961 is designed for standard 19" rack mounting and occupies 2U of rack space. Fibre or plastic washers may be used to prevent the front panel becoming marked by the mounting bolts.

- Care should be taken in the choice of positioning. The unit should not be mounted where other equipment obstructs the normal air flow. The unit should not be situated near any heat source, such as a radiator, stove or a high power amplifier that would generate heat.
- The appliance should not be operated near any water or in a location where moisture might be present.
- Always connect the mains earth to the unit.

If the 1973 is to be continuously moved from one location to another, we suggest using additional support in the rack at the rear of the unit.

POWER CONNECTION

The unit will have been supplied with a power cable suitable for domestic power outlets in your country. For your own safety it is important that you use this cable. The unit should **always** be connected to the mains supply earth using this cable, and no other.

If for some reason the unit is to be used at a mains input operating voltage which is different to that as supplied, the following procedure must be carried out.

- 1: Disconnect the unit from the mains.
- 2: Remove the two screws holding the voltage selection cover-plate.
- 3: Remove the cover plate and slide the switch fully to its opposite end.
- 4: Rotate the cover plate one half turn (180 degrees) and refit the two screws.
- 5: Replace with a correctly rated fuse for the selected operation voltage in the IEC socket:
230V-T250mA and 115V-T500mA
- 6: Re-connect to mains power source.

**Never disconnect the earth
from the mains supply**

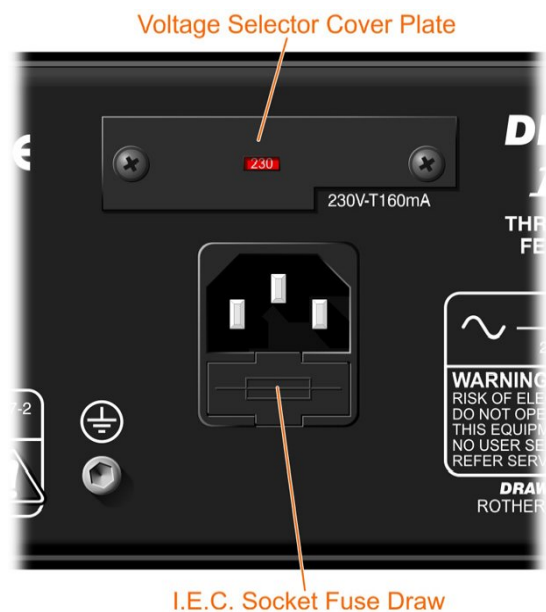

AUDIO CONNECTIONS

A typical setup for connecting the 1973 would be by the use of a Y-lead between the two input and output xlr's on the rear of the 1973 and insert point for the respective channel of the desk - this would be repeated for both channels. The wiring of the Y-lead can be seen below.

The inputs and outputs are electronically balanced on conventionally wired XLRs (pin 1 screen, pin 2 hot, pin 3 cold and XLR shell is connected to chassis). The operating level is nominally +4dBu. Balanced use is recommended.

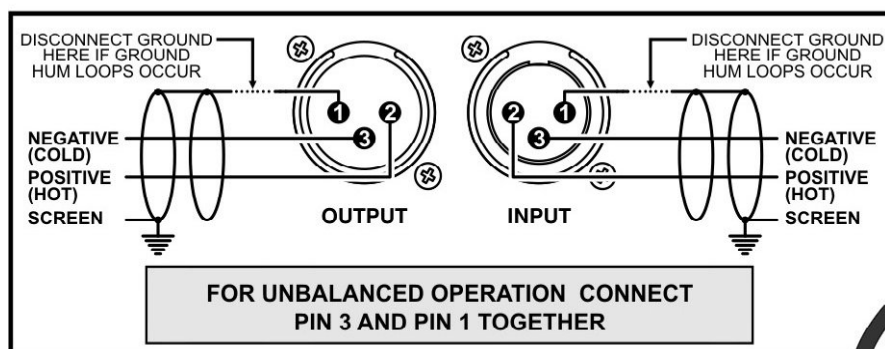
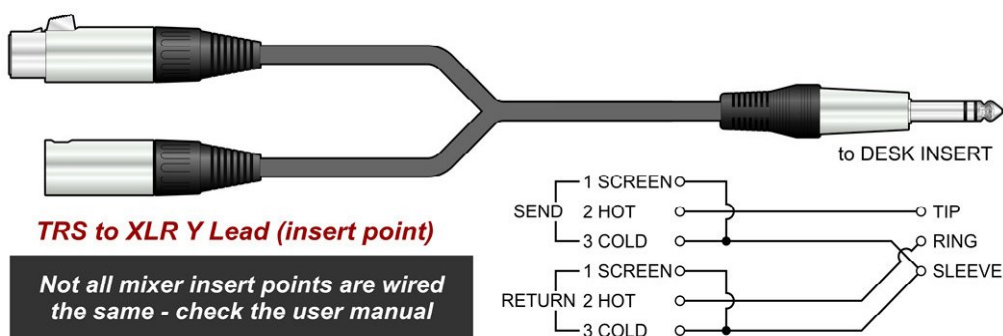

- **Ground Loops:**

If ground loop problems are encountered, never disconnect the mains earth, but instead, try disconnecting the signal screen on one end of each of the cables connecting the outputs of the 1973 to the patchbay. If such measures are necessary, balanced operation is recommended.

- **Interference:**

If the 1973 is to be used where it may be exposed to high levels of disturbance such as found close to a TV or radio transmitter, we advise that it is operated in a balanced configuration. The screens of the signal cables should be connected to the chassis connection on the XLR connector as opposed to connecting to pin 1.

The 1973 conforms to the EMC standards.

Stereo Signal Input

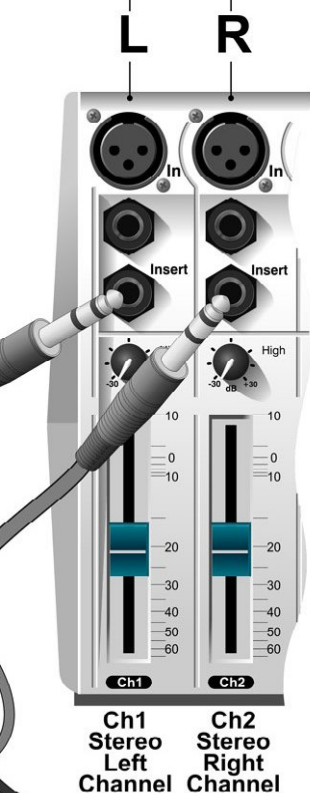

CONTROL DESCRIPTION

The 1973 shares similar parameters to a standard full band compressor, such as the Drawmer 1968, the difference being that the stereo signal is split into low, mid and high bands, each one processed separately without affecting the other, and then summed back into a stereo signal again before output.

As you would imagine a multiband compressor could become a very intimidating beast due to the number of controls, however, the 1973 as been layed out to be as intuitive to use as possible. Anyone familiar with the Drawmer 1960's range, the S2 and especially the S3 compressors should be immediately at home.

Essentially the 1973 comprises the three low, mid and high compressor bands to the left of the unit with the crossover frequency knobs inbetween. These bands are all almost identical, the only difference being the Big and Air switches. To the right of the unit the meters and output sections are located (see below diagram).

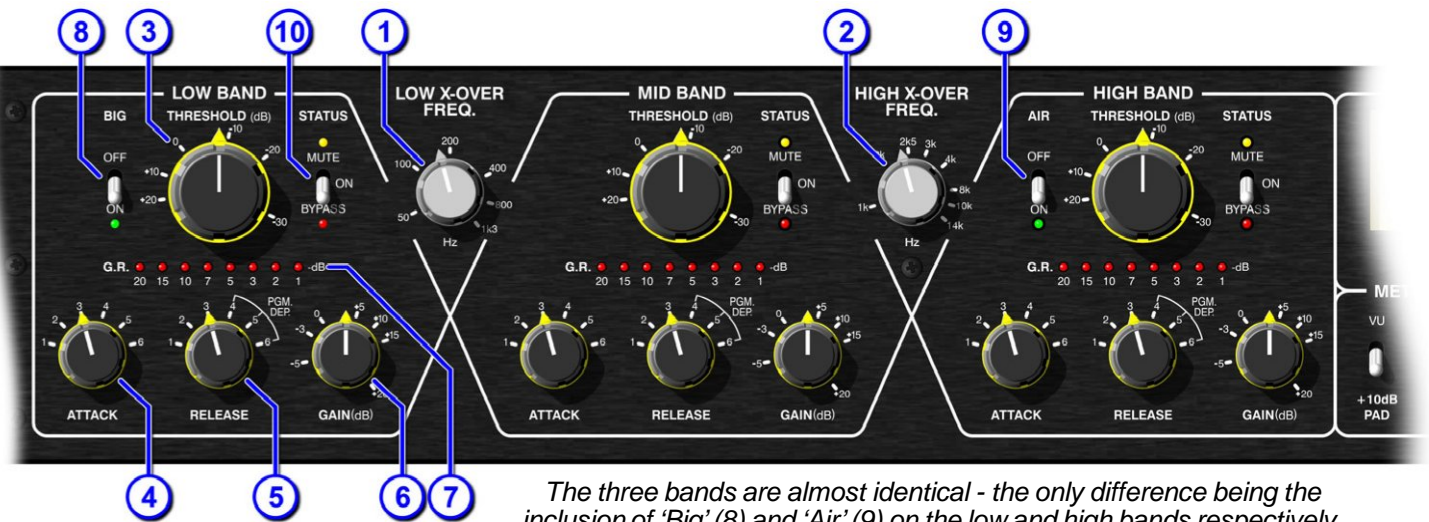
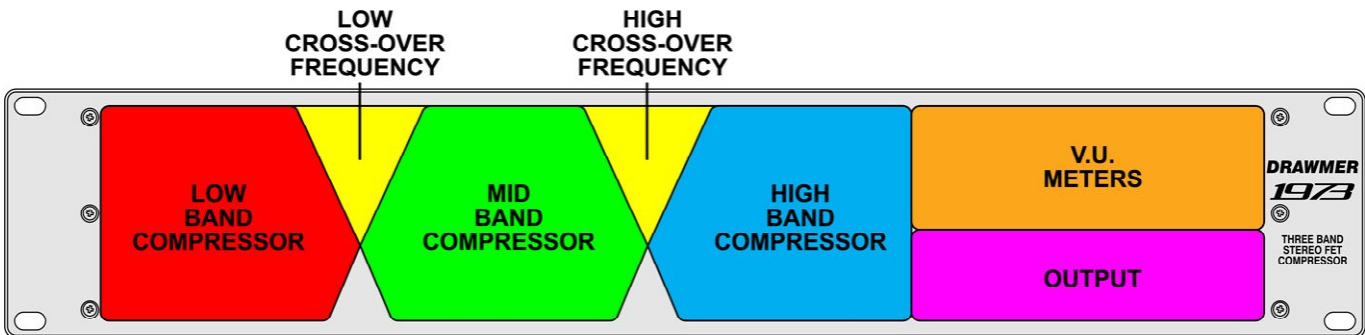
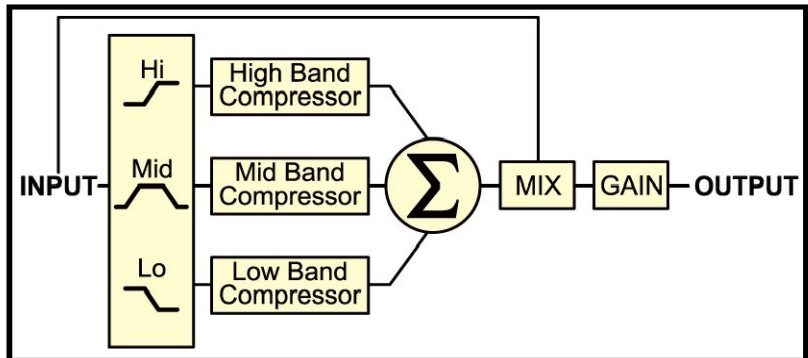

The three bands are almost identical - the only difference being the inclusion of 'Big' (8) and 'Air' (9) on the low and high bands respectively.

X-OVER FREQUENCIES

The 6dB per octave crossover frequencies determine the points within the frequency spectrum one band stops to process audio, and another band takes over.

- 1 **Low X-Over Frequency: 50Hz - 1.3kHz**
Sets the frequency point at which the split between low and mid bands occurs.
- 2 **High X-Over Frequency: 1kHz - 14kHz**
Sets the frequency point at which the split between mid and high bands occurs.

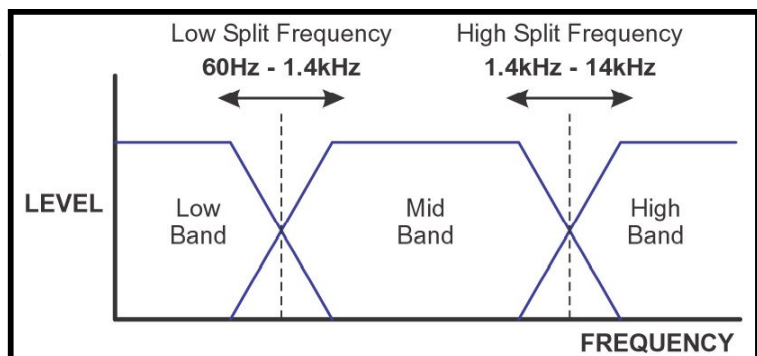

The following diagram provides a good, but general, idea of some useful frequencies that will aid in setting the crossover frequencies:

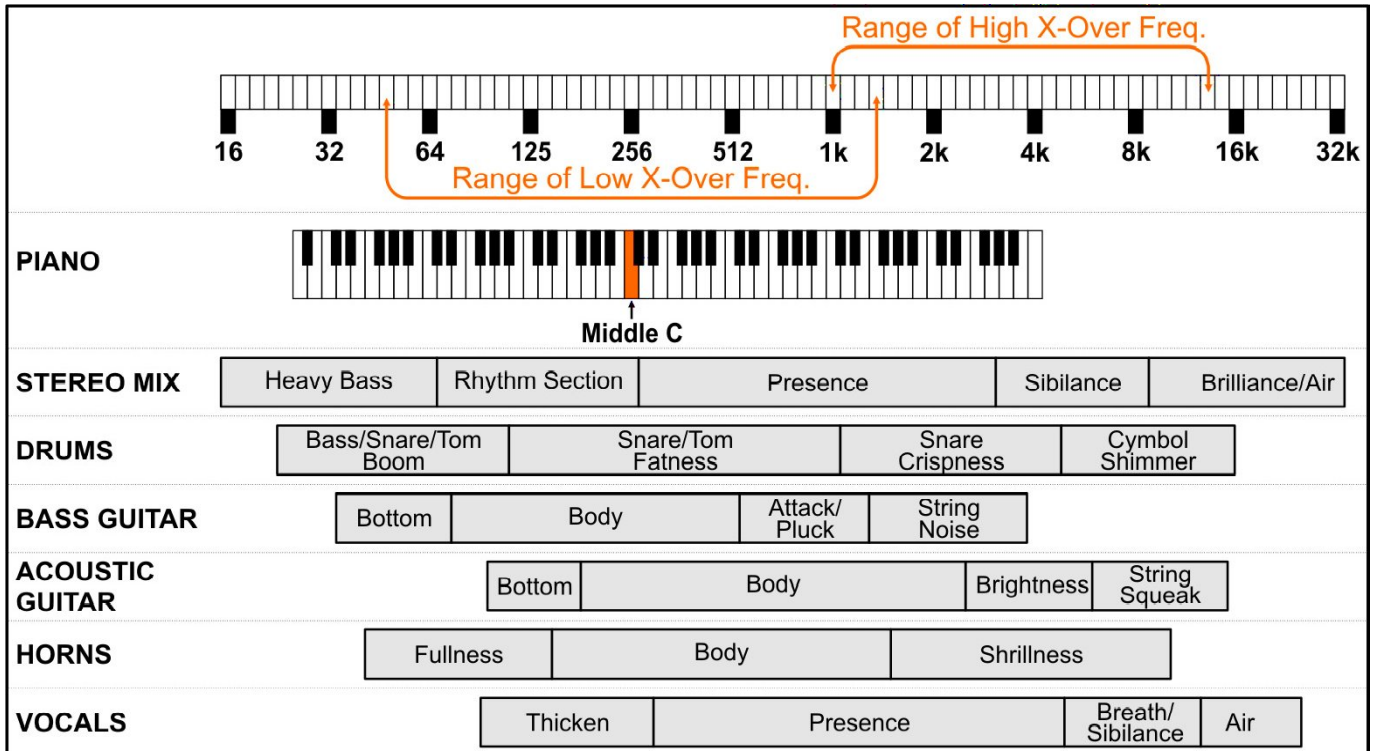

LOW BAND, MID BAND, HIGH BAND

- 3 Threshold:** *infinity - -32dB all bands*
 Determines the level below which compression starts to take place. The 1973 incorporates a Soft Knee, more compression is applied automatically as the input signal level increases, negating the need for a Ratio control.
- 4 Attack:** *see below diagram all bands*
 Controls the speed that the compressor responds to signals that exceed the level set by threshold. Six switchable Attack settings. All times are nominal, the actual attack time is further modified by the release setting chosen.
- 5 Release:** *see below diagram all bands*
 Sets the time taken for the signal to return to normal after the input level has fallen below threshold. The first three switch positions are fixed and provide progressively increasing release times, while positions F(ast), M(id) and S(low) cause the release times to vary in a manner which automatically adapts to the dynamics of the incoming signal.

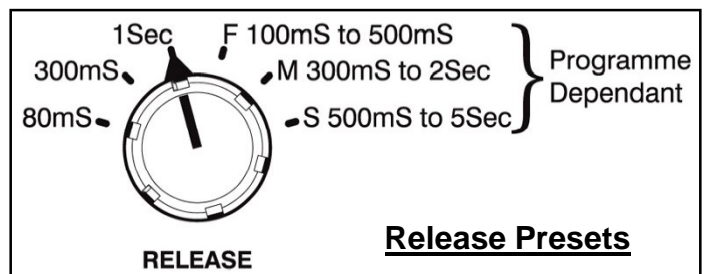
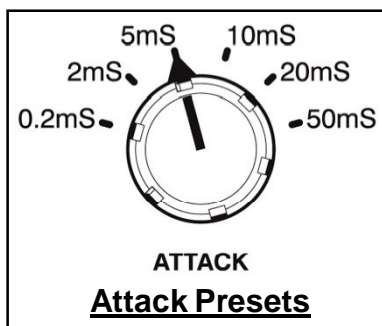
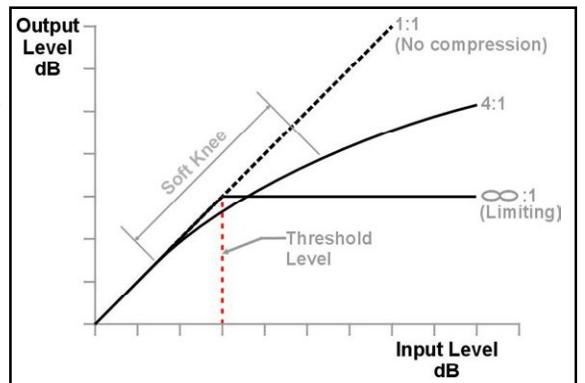

- 6 Gain:** *-10 - +20dB all bands*
 During compression the signal is attenuated, gain may be required to produce the required output level. In addition, as the 1973 is multi-band, the three gain controls are used to adjust the levels of each band to obtain a desirable overall signal, or to bring out the bass, treble etc.
- 7 Gain Reduction Meter:** *-1,-2,-3,-5,-7,-10,-15,-20dB all bands*
 Use the meter as a guide to how much gain to re-apply using the Gain control **6**.

8 Big: *Off - On* *low band only*
 Big is located only on the low band and when on reduces the side-chain's sensitivity to low frequencies, with the result that less gain reduction is applied, creating the effect that the bass is louder or 'bigger'. The 'BIG' mode enables application in buss compression situations where you still want thick and warm tone yet complete dynamics control.

9 Air: *Off - On* *high band only*
 Air is located only on the high band and is used to re-introduce high frequencies, which can sometimes be lost after heavy compression so that it sounds more intimate, detailed and transparent, but without making it sound harsh or introducing any noticeably unnatural artifacts. Cymbals are more vibrant without becoming splashy, and vocals sound more open but without becoming sibilant.

10 Status: *Mute/On/Bypass* *all bands*
 A three position Status switch is located in each of the bands that allows normal operation, bypass or muting of that band. In the ON position all the controls of that particular band are in operation and compression takes place. In the "BYPASS" position the signal for the low, mid, or high band is allowed to pass through to the summing stage without being altered by the compressor stage (including gain). In the "MUTE" position the signal for that particular band is effectively turned off - any combination of mute is available, to hear only the signal of the low band mute the mid and high bands etc.
 Using a combination of mute and bypass switches for the various bands allows the operator to hear and monitor only the frequencies that are required and so 'tune in' to the low, mid and high frequency settings using the cross-over controls.

METERS

11 VU Meter:
 Two backlit moving coil VU meters monitor the level of the output signal. Note: To see the input level on the VU meters the Bypass switch should be on.

12 Pad: *Vu - +10dB*
 A two position switch adjusts the meters to show either normal output level, (and for those working at 'hot' output levels) VU +10dB i.e. with the switch at VU +10dB, when the VU meter reads 0dB the actual level is +10dB.

13 Peak VU: *Peak VU - VU*
 On smooth, gentle pieces of music the "VU" (average level) setting would be sufficient, however, on fast dynamic signals the "Peak VU" setting provides more accurate readings.

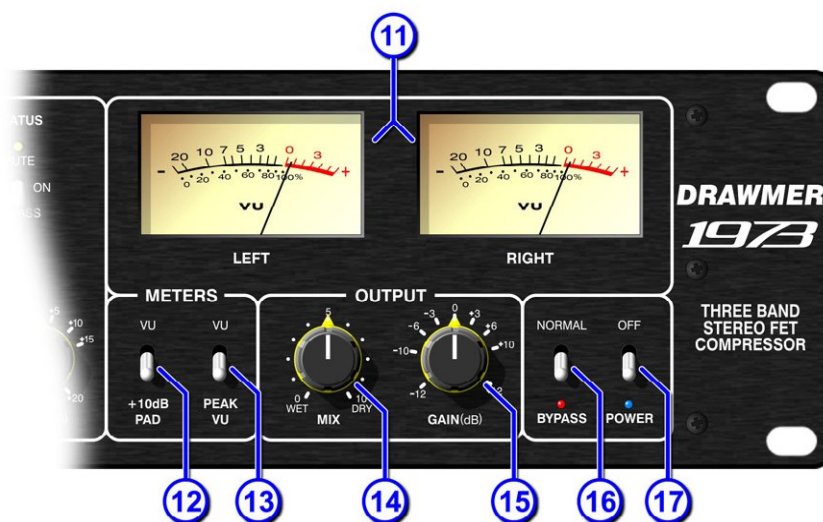

OUTPUT

14 Mix: *WET - DRY*
 A variable control that mixes a user defined amount of 'uncompressed' signal (dry) with the compressed signal (wet) to create a 'parallel compression effect' without the need for external mixing devices. In this way the amount of overall compression on the stereo signal is under complete control - set the three bands to provide heavy compression but then reduce the overall effect by mixing in some of the dry signal using the mix control.

15 Gain: *-12 - +12dB*
 The 1973 provides a single control to modify the stereo output level after summing, without having to adjust the three band gain controls (and thus altering the mix). Adjust so that the output signal approaches the desired level only on signal peaks.

16 Bypass: *Off - On*
 A fully balanced hard-wire unit bypass connects the input directly to the output without alteration. Note: To see the input level on the VU meters the Bypass switch should be on, as the meters display the level found at the output.

17 Power: *Off - On*
 Turns the 1973 on and off. This switch is hard wired and so when off the 1973 will draw no power

QUICK SETUP PROCEDURE

Please note that the following procedure is only a guide. All audio is different, requiring numerous settings, however, this should give a good starting point:

- 1) Set the compressor settings to be the same on all bands - **Threshold** fully counter-clockwise, **Gain** at 0dB, the **Attack** in a mid position (2 or 3) and **Release** set to F(ast). The overall **Gain** control should be set to 0dB, and the **Mix** at 0 (Wet).

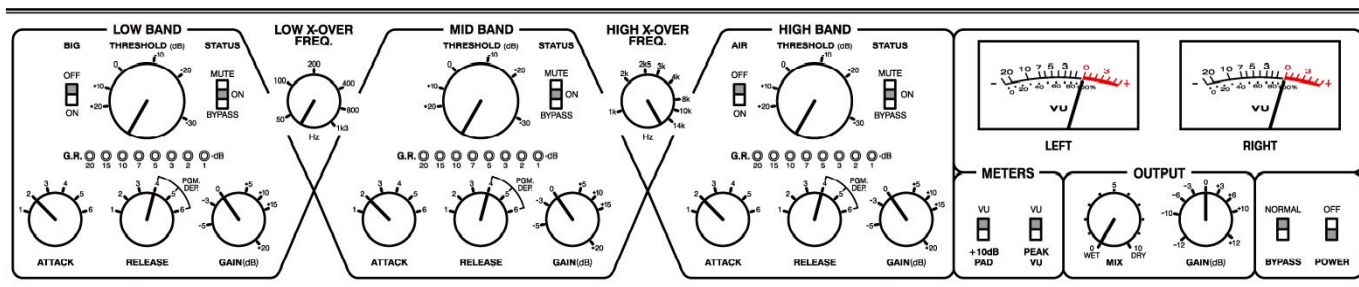

- 2) Turn on the **Bypass** switch (bottom right) so that the input signal is heard without compression and adjust the incoming signal until the **VU meters** rear 0dB. Set the **Bypass** switch back to Normal.
- 3) With the **Low X-Over Frequency** set fully counter-clockwise, and the **High X-Over Frequency** set fully clockwise, listen to the audio and bring in the two knobs to the positions that you think the cross-over points should be set - generally to separate the main bass and treble sounds from the mid-range. Using a combination of **Mute** and **Bypass** switches for the various bands allows the operator to monitor only the frequencies that are required and so tune the low, mid and high frequencies.
- 4) Keeping an eye on the **Gain Reduction Meters** alter the **Threshold** level control for each band until the desired compression level is achieved - a G.R. level up to -10dB is acceptable.
- 5) Adjust the **Gain** control of each band until 0dB is reached on the **Output VU meter**. To see only the band that is being adjusted on the VU meter **Mute** the other two bands.
- 6) Set the **Attack** and **Release** settings of each band to suit the audio being compressed.
- 7) The **Threshold** and **Gain** of each band can be modified to achieve the desired compression, levels and tonal balance to the overall signal.
- 8) At this point the **Bypass** switch can be toggled to listen to the affect that the 1973 is having on the audio. Adjust to suit.
- 9) Once each band is setup correctly modify the overall **Output Gain** and **Mix** until the VU meters read 0dB (more if in +10dB VU mode) and the desired amount of compression is heard.

Below is an example setup that could be used for a General Pop Mix, though, of course, as all music is diverse and varied, will not be ideal elsewhere.

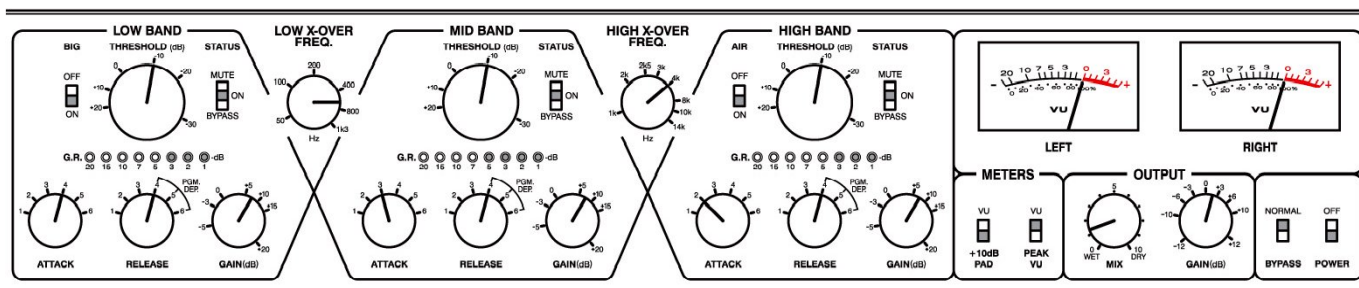

GENERAL INFORMATION

IF A FAULT DEVELOPS

For warranty service please call Drawmer Electronics Ltd. or their nearest authorised service facility, giving full details of the difficulty.

A list of all main dealers can be found on the Drawmer webpages.

On receipt of this information, service or shipping instructions will be forwarded to you.

No equipment should be returned under the warranty without prior consent from Drawmer or their authorised representative.

For service claims under the warranty agreement a service Returns Authorisation (RA) number will be issued. Write this RA number in large letters in a prominent position on the shipping box. Enclose your name, address, telephone number, copy of the original sales invoice and a detailed description of the problem.

Authorised returns should be prepaid and must be insured.

All Drawmer products are packaged in specially designed containers for protection. If the unit is to be returned, the original container must be used. If this container is not available, then the equipment should be packaged in substantial shock-proof material, capable of withstanding the handling for the transit.

CONTACTING DRAWMER

Drawmer Electronics Ltd., will be pleased to answer all application questions to enhance your usage of this equipment. Please address correspondence to:

Drawmer (Technical Help line)
Coleman Street
Parkgate
Rotherham
S62 6EL
UK

Alternatively contact us by E-mail on :

for sales enquiries: sales@drawmer.com
or for technical issues: tech@drawmer.com

Further information on all Drawmer dealers, Authorised service departments and other contact information can be obtained from our web pages on:

<http://www.drawmer.com>

1973 THREE-BAND STEREO VACUUM TUBE COMPRESSOR DATA SPECIFICATION

INPUT

Input Impedance 20k Ohms or greater
Maximum Input Level +26dBu

OUTPUT

Output Impedance 100 Ohms
Maximum Output Level +25dBu into 10k Ohms Load

FREQUENCY RESPONSE

<5Hz to 51kHz -1dB
<3Hz to 70kHz -3dB

CROSSTALK

< -80dB @ 1kHz

NOISE AT UNITY GAIN

with flat EQ response switched in circuit

	Wideband	22Hz - 22kHz
AV	-82dB	-87dB

% DISTORTION (THD & NOISE) @ 1kHz

0dB (ref +4) 0.03%
10dB (ref +4) 0.07%
20dB (ref +4) 0.5%

POWER REQUIREMENTS

230Volt or 115V at 50-60Hz, 60VA

FUSE RATING

T250mA for 230Volt,
T500mA for 115Volt
Conforming to IEC 127-2

FUSE TYPE

20mm x 5mm, Class 3 Timed-Blo, 250Volt working

CASE SIZE

482mm (W) x 132mm (H) x 315mm (D)

WEIGHT

9.7Kgs

BLOCK DIAGRAM

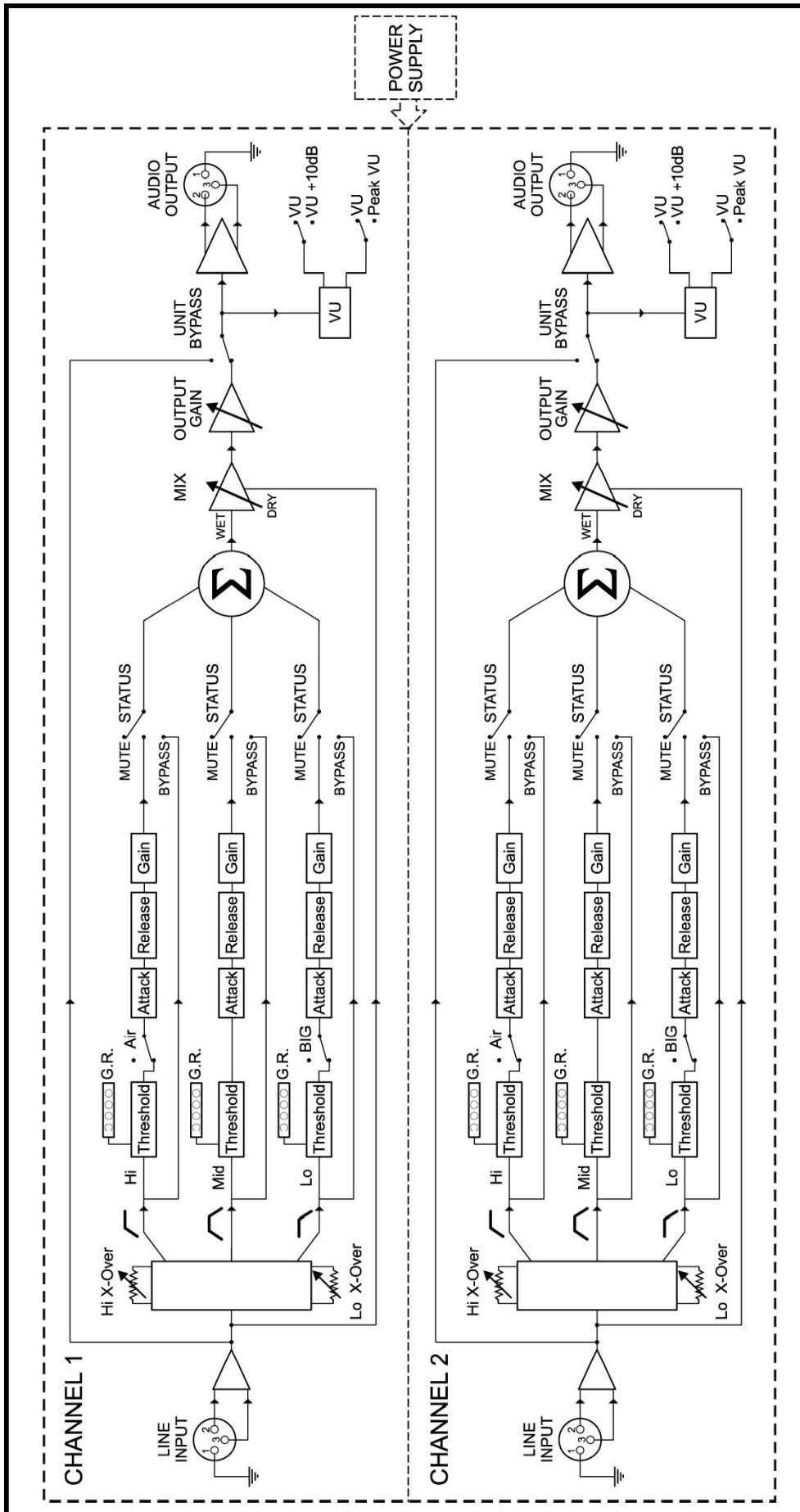

LOW BAND THRESHOLD (dB)

0 20 40 60 80 100

STATUS: MUTE BYPASS

G.R. 20 15 10 7 5 3 2 1

ATTACK RELEASE GAIN (dB)

LOW X-OVER FREQ.

50 100 200 400 800 1k3

STATUS: MUTE BYPASS

G.R. 20 15 10 7 5 3 2 1

ATTACK RELEASE GAIN (dB)

MID BAND THRESHOLD (dB)

0 20 40 60 80 100

STATUS: MUTE BYPASS

G.R. 20 15 10 7 5 3 2 1

ATTACK RELEASE GAIN (dB)

HIGH X-OVER FREQ.

2k 2.5k 3k 4k 8k 10k 14k

STATUS: MUTE BYPASS

G.R. 20 15 10 7 5 3 2 1

ATTACK RELEASE GAIN (dB)

HIGH BAND THRESHOLD (dB)

0 20 40 60 80 100

STATUS: MUTE BYPASS

G.R. 20 15 10 7 5 3 2 1

ATTACK RELEASE GAIN (dB)

AIR THRESHOLD (dB)

0 20 40 60 80 100

STATUS: MUTE BYPASS

G.R. 20 15 10 7 5 3 2 1

ATTACK RELEASE GAIN (dB)

METERS

VU +10dB PAD

VU PEAK

VU WET MIX

OUTPUT

GAIN (dB)

NORMAL BYPASS

OFF POWER

LEFT

RIGHT

DRAWMER

1973

Session Recall

DRAWMER ELECTRONICS LTD ~ Coleman Street
Rotherham ~ S. Yorkshire ~ UK

© COPYRIGHT DRAWMER ELECTRONICS LTD 2014

Session No.	
Date	
Artist	
Tape Location	