

th•mann

DP-95 B, DP-95 WH
digitalpiano



Musikhaus Thomann
Thomann GmbH
Hans-Thomann-Straße 1
96138 Burgebrach
Deutschland
Telephone: +49 (0) 9546 9223-0
E-mail: info@thomann.de
Internet: www.thomann.de

06.02.2018, ID: 352288, 352389 (V2)

Table of contents

1	General information	5
	1.1 Further information.....	5
	1.2 Notational conventions.....	5
	1.3 Symbols and signal words.....	6
2	Safety instructions	7
3	Features	9
4	Assembly instructions	10
5	Control panel and connections	16
6	Connectivity options	21
7	Switching on / off, basic operation	23
	7.1 Turning the digital piano on and off.....	23
	7.1.1 Normal switching on / off.....	23
	7.1.2 Automatic shutdown.....	23
	7.2 Setting up the digital piano, Function menu.....	23
	7.2.1 Fine tuning.....	24
	7.2.2 Split point.....	25
	7.2.3 Beats.....	25
	7.2.4 Metronome volume.....	25
	7.2.5 Pedal function selection.....	26
	7.2.6 Reverb volume.....	26
	7.2.7 Chorus volume.....	26
	7.2.8 Selecting a setting for the Harmony mode.....	27
	7.2.9 Effects depth in Harmony mode.....	28
	7.2.10 Midi receive channel (Midi In).....	28
	7.2.11 MIDI send channel (Midi Out).....	28
	7.2.12 Automatic shutdown.....	29
	7.2.13 Time signature.....	29
	7.3 Adjusting the volume.....	29
	7.4 Setting the Brilliance.....	30
	7.5 Transposing.....	30
	7.6 Touch sensitivity.....	30
	7.7 DSP effects depth.....	31
	7.8 Factory defaults.....	31
8	Operating	32
	8.1 Demo songs.....	32
	8.2 Practise songs.....	32
	8.3 Metronome.....	34
	8.4 Piano mode.....	35
	8.5 Dual mode.....	35
	8.6 Split mode.....	35
	8.7 TWINOVA.....	36

8.8	Selecting voices	36
8.9	Harmony mode.....	37
8.10	Playing with accompaniment.....	37
8.10.1	Style selection.....	37
8.10.2	Playing Styles, Chord mode.....	37
8.10.3	Tempo.....	38
8.10.4	Mixer.....	38
8.11	Auto Accompaniment.....	39
8.12	Accompaniment track volume, muting.....	39
8.13	Performance Assistant.....	39
8.13.1	GUITAR mode.....	40
8.13.2	PIANO mode.....	41
8.13.3	TRADITIONAL CHINESE INSTRUMENTS mode.....	41
8.14	Chord detection.....	41
8.15	Historic tunings.....	44
8.16	One Touch Setting.....	45
8.17	Record, playback, delete.....	45
8.17.1	Song recording.....	46
8.17.2	Playback recordings.....	47
8.17.3	Delete recording.....	47
8.18	Memory.....	47
8.18.1	Memory banks.....	47
8.18.2	Load / save parameters.....	48
8.18.3	Lock function.....	48
8.19	Song album.....	48
8.20	Chord dictionary.....	49
8.21	MIDI functions.....	50
8.22	USB connection.....	50
9	Troubleshooting.....	51
10	Voice list.....	52
11	Styles list.....	61
12	Practise and demo songs.....	65
13	Chord list.....	67
14	MIDI implementation chart.....	69
15	Technical specifications.....	71
16	Protecting the environment.....	72

1 General information

This manual contains important instructions for the safe operation of the unit. Read and follow the safety instructions and all other instructions. Keep the manual for future reference. Make sure that it is available to all those using the device. If you sell the unit please make sure that the buyer also receives this manual.

Our products are subject to a process of continuous development. Thus, they are subject to change.

1.1 Further information

On our website (www.thomann.de) you will find lots of further information and details on the following points:

Download	This manual is also available as PDF file for you to download.
Keyword search	Use the search function in the electronic version to find the topics of interest for you quickly.
Online guides	Our online guides provide detailed information on technical basics and terms.
Personal consultation	For personal consultation please contact our technical hotline.
Service	If you have any problems with the device the customer service will gladly assist you.

1.2 Notational conventions

This manual uses the following notational conventions:

Letterings

The letterings for connectors and controls are marked by square brackets and italics.

Examples: *[VOLUME]* control, *[Mono]* button.

Displays

Texts and values displayed on the device are marked by quotation marks and italics.

Examples: '24ch', 'OFF'.

Instructions

The individual steps of an instruction are numbered consecutively. The result of a step is indented and highlighted by an arrow.

Example:

1. ➤ Switch on the device.
2. ➤ Press [Auto].
⇒ Automatic operation is started.
3. ➤ Switch off the device.



Cross-references

References to other locations in this manual are identified by an arrow and the specified page number. In the electronic version of the manual, you can click the cross-reference to jump to the specified location.

Example: See ➤ 'Cross-references' on page 6.

1.3 Symbols and signal words

In this section you will find an overview of the meaning of symbols and signal words that are used in this manual.

Signal word	Meaning
DANGER!	This combination of symbol and signal word indicates an immediate dangerous situation that will result in death or serious injury if it is not avoided.
CAUTION!	This combination of symbol and signal word indicates a possible dangerous situation that can result in minor injury if it is not avoided.
NOTICE!	This combination of symbol and signal word indicates a possible dangerous situation that can result in material and environmental damage if it is not avoided.
Warning signs	Type of danger
	Warning – high-voltage.
	Warning – danger zone.

2 Safety instructions

Intended use

This device is intended to be used for electronic sound generation using a piano keyboard. Use the device only as described in this user manual. Any other use or use under other operating conditions is considered to be improper and may result in personal injury or property damage. No liability will be assumed for damages resulting from improper use.

This device may be used only by persons with sufficient physical, sensorial, and intellectual abilities and having corresponding knowledge and experience. Other persons may use this device only if they are supervised or instructed by a person who is responsible for their safety.

Safety

**DANGER!****Danger for children**

Ensure that plastic bags, packaging, etc. are disposed of properly and are not within reach of babies and young children. Choking hazard!

Ensure that children do not detach any small parts (e.g. knobs or the like) from the unit. They could swallow the pieces and choke!

Never let children unattended use electrical devices.

**DANGER!****Electric shock caused by short-circuit**

Do not modify the mains cable or the plug. Failure to do so could result in electric shock/death or fire. If in doubt, seek advice from a registered electrician.

**DANGER!****Electric shock caused by high voltages inside**

Within the device there are areas where high voltages may be present. Never remove any covers.

There are no user-serviceable parts inside.

Do not use the device if covers, protectors or optical components are missing or damaged.

**CAUTION!****Possible hearing damage**

With loudspeakers or headphones connected, the device can produce volume levels that may cause temporary or permanent hearing impairment.

Do not operate the device permanently at a high volume level. Decrease the volume level immediately if you experience ringing in your ears or hearing impairment.

**CAUTION!****Risk of injury due to heavy weight**

Due to the heavy weight of the device, at least two persons are required for transport and installation.

**NOTICE!****Operating conditions**

This device has been designed for indoor use only. To prevent damage, never expose the device to any liquid or moisture. Avoid direct sunlight, heavy dirt, and strong vibrations.

**NOTICE!****Power supply**

Before connecting the device, ensure that the input voltage (AC outlet) matches the voltage rating of the device and that the AC outlet is protected by a residual current circuit breaker. Failure to do so could result in damage to the device and possibly injure the user.

Unplug the device before electrical storms occur and when it is unused for long periods of time to reduce the risk of electric shock or fire.

3 Features

The digital piano is characterized by the following features:

- 88 weighted keys with hammer action, touch velocity in 3 steps.
- Multi function LCD.
- User-friendly controls and indicators.
- 500 voices.
- 200 preprogrammed styles.
- 60 preprogrammed practise songs.
- Three memory locations for user songs.
- Song album with 120 songs.
- Two demo songs.
- Sequencer function.
- Single and multi-finger chord detection.
- Recording function.
- Eight memory banks, each with four memory locations.
- Mixer function.
- Connections: USB, 2 × headphones, AUX, MIDI, pedal box.

4 Assembly instructions

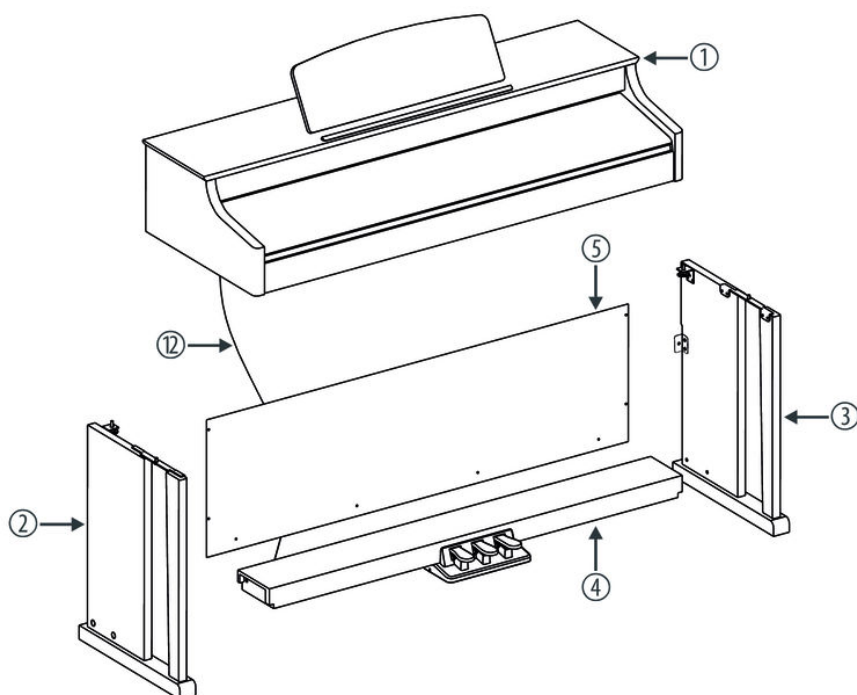

You need a Phillips screwdriver (not supplied) for the assembly of the digital piano. Open the package and please make sure before assembling that the entire scope of delivery is present, as posted here.

1	Digital piano housing with music stand
2	Left side panel
3	Right side panel
4	Pedal box
5	Back panel
6	2 × screws M6 × 18
7	2 × hand screws
8	4 × screws M6 × 40
9	8 × screws M4 × 15
10	2 × screws M6 × 12
11	4 × plastic caps
12	Pedal cable
13	Power cord

Mechanical assembly

1. ➤ Assemble the piano near a wall power outlet.
2. ➤ Proceed according to the illustrations and exclusively use the supplied screws. Using other screws could damage the piano housing or result in a reduced stability of the piano.

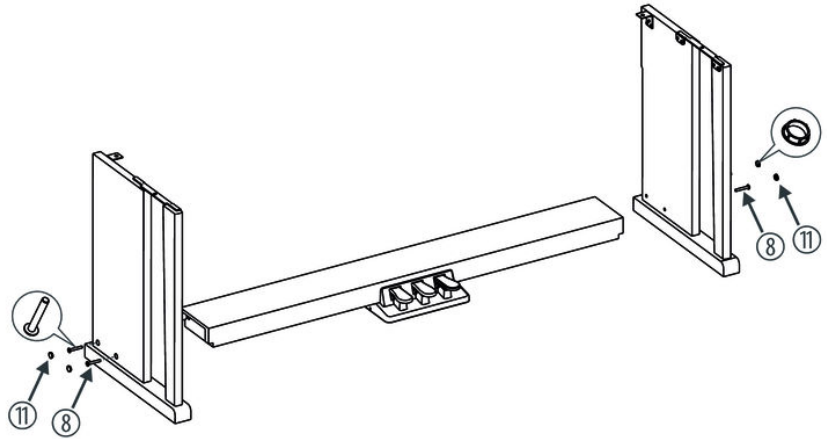

3. ➤ Put the pedal box between the left and right side panel and use two screws M6 × 40 on each side to affix both side panels to the pedal box.

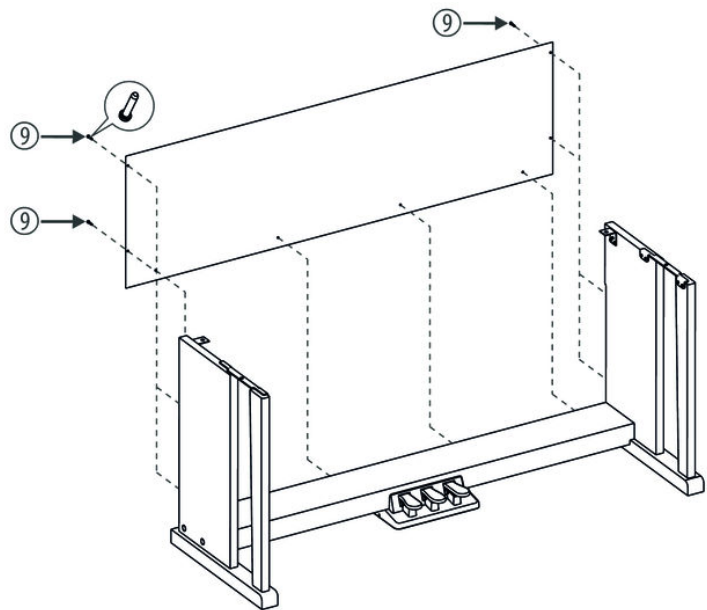

4. ➤ Attach the back panel with eight screws M4 × 15 and two screws M6 × 12 to the pedal box and to the rear sides of the side panels.

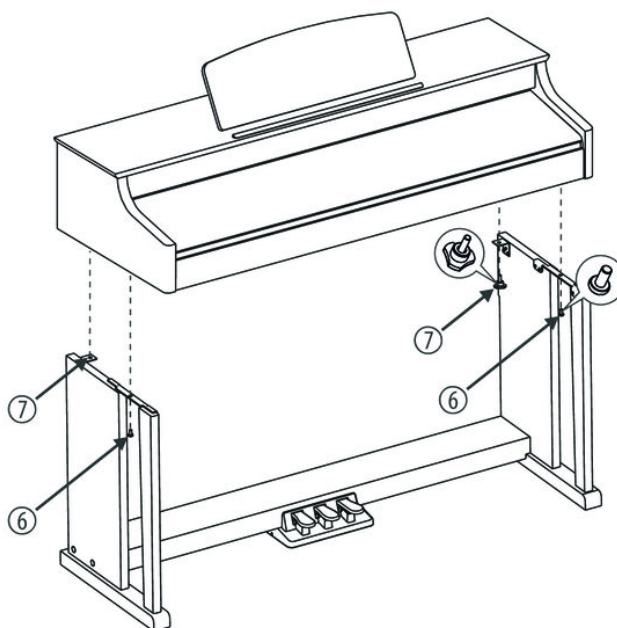

- 5.** Place the digital piano case on the frame and secure it with two screws M6 × 18 and the two thumbscrews.

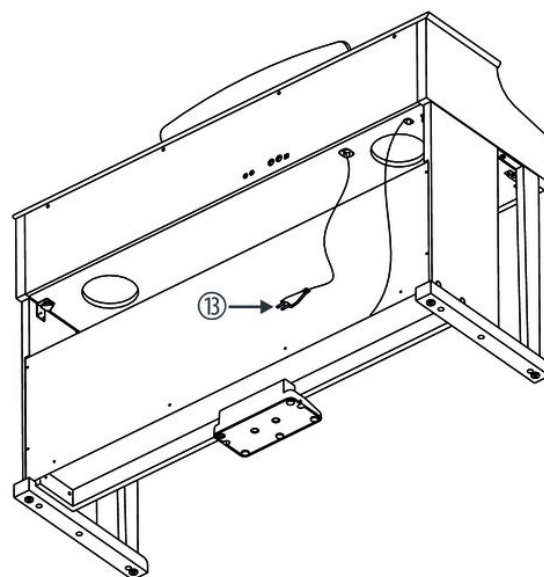

- 6.** Fasten the cables to the stand. Insert the DIN plug of the pedal cable into the provided socket on the bottom side of the digital piano. Move the digital piano to its designated location.

Mains connection



1. ➤ Make sure that the device is turned off before you connect it to the power supply or disconnect it.
2. ➤ Turn the volume control to minimum.

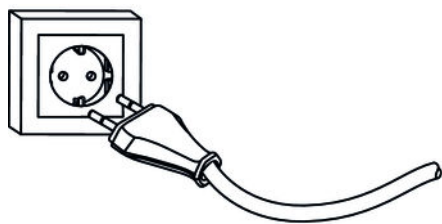

3. ➤ Plug the power cord into a 230 V AC outlet.
4. ➤ Now you can turn on the device.



If the piano is not in use or when a thunderstorm with danger of lightning threatens, disconnect the device from its mains power for safety.

Assembly overview

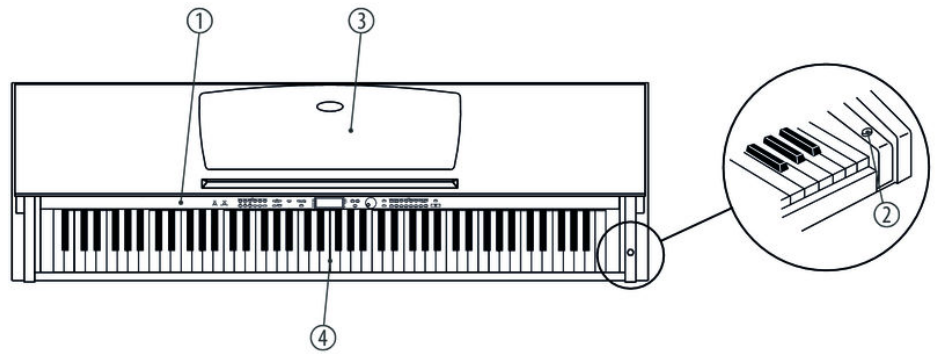

Top view

1	Operating panel
2	Main switch
3	Music stand
4	Claviature

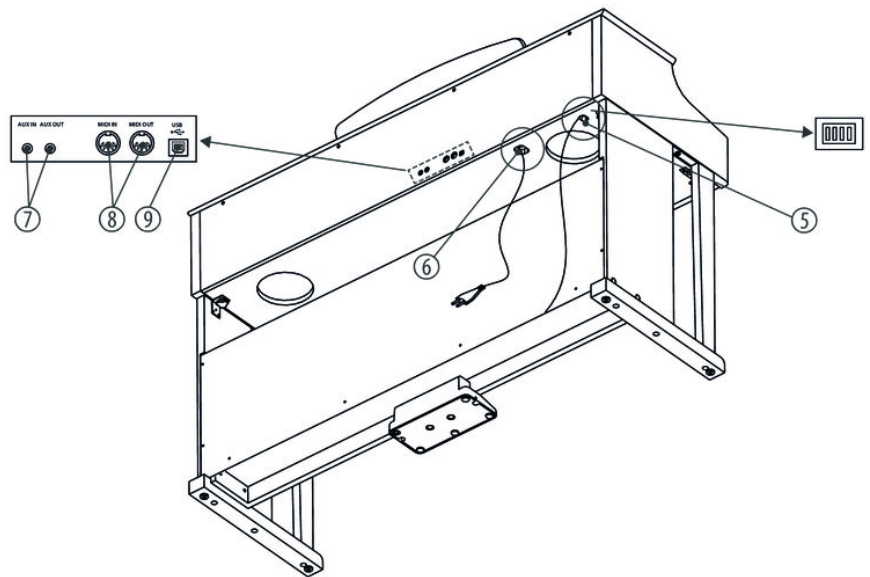

Rear panel

5	Connection for pedal cable
6	Power cord
7	AUX input, AUX output
8	MIDI input, MIDI output
9	USB port

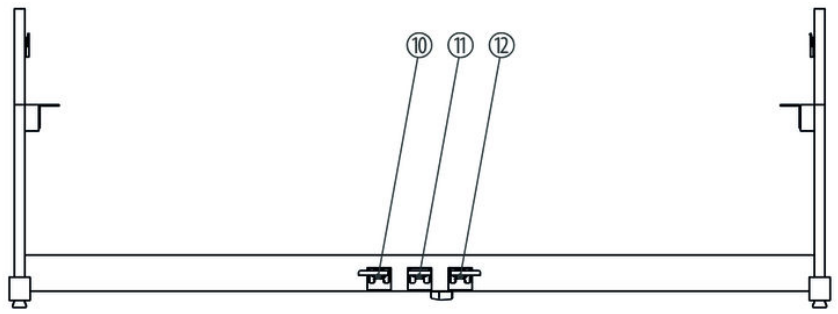



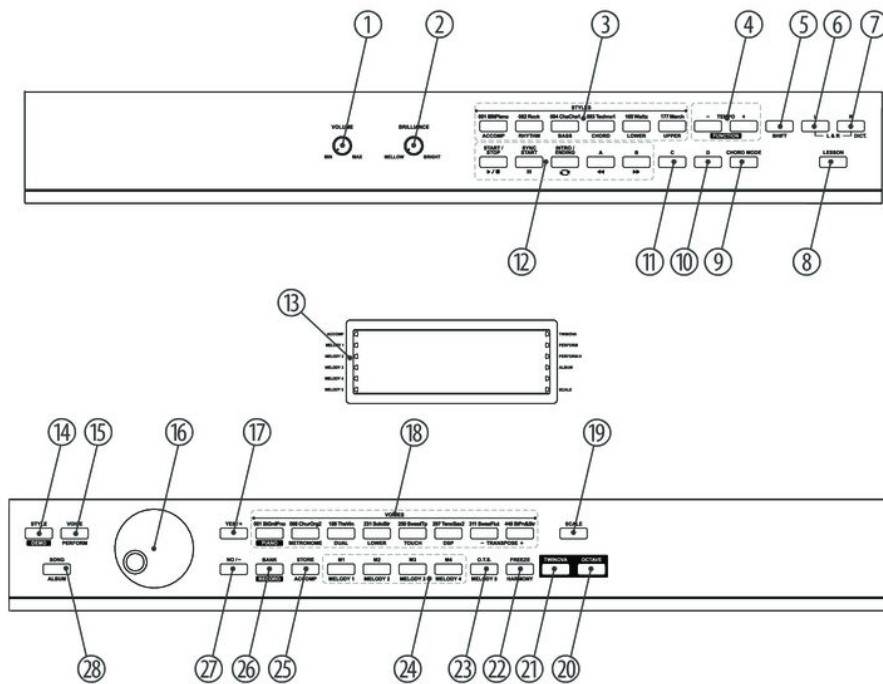

Pedals

10	Soft pedal
11	Sostenuto pedal
12	Sustain pedal

5 Control panel and connections



- 1 **[VOLUME]**
Rotary volume control.
- 2 **[BRILLIANCE]**
Rotary brilliance control.
- 3 **[STYLES]**
Single button function: direct Style selection.
Button function with pressed **[SHIFT]** button in 'MIXER' mode:
 - **[ACCOMP]**
Setting the accompaniment track volume.
 - **[RHYTHM]**
Setting the rhythm section volume.
 - **[BASS]**
Setting the bass section volume.
 - **[CHORD]**
Setting the chord section volume.
 - **[LOWER]**
Setting the dual voice volume.
 - **[UPPER]**
Setting the first voice volume.

4	[TEMPO +] [TEMPO -] [FUNCTION] Single button function: Increasing / decreasing playback tempo. Button function with pressed [SHIFT] button: Opening function menu	
5	[SHIFT] Enables the second function of doubly assigned function buttons.	
6	[L] Left hand voice selection button in lesson mode.	
7	[R] [DICT] Single button function: Right hand voice selection button in lesson mode. Button function with pressed [SHIFT] button: Opening chord dictionary.	
8	[LESSON] Button to call the lesson mode.	
9	[CHORD MODE] Button to call the chord mode.	
10	[D] Button to insert a fill bar (Fill-in D).	
11	[C] Button to insert a fill bar (Fill-in C).	
12	Buttons for operating mode STYLE <ul style="list-style-type: none"> ■ START / STOP ■ SYNC / START ■ INTRO / ENDING ■ FILL A ■ FILL B 	Buttons for operating mode SONG <ul style="list-style-type: none"> ■ START / STOP  ■ PAUSE  ■ REPEAT  ■ REW  ■ FF 
13	Display.	
14	[STYLE] [DEMO] Single button function: Calling Style mode. Button function with pressed [SHIFT] button: Calling Demo mode.	
15	[VOICE] [PERFORM] Single button function: Calling Voice mode. Button function with pressed [SHIFT] button: Calling Performance-Assistant mode	
16	Jog dial for selecting functions, parameters and values.	
17	[YES/+]. Increases the displayed value by one.	

18	<p><i>[VOICES]</i></p> <p>Single button function: direct Voice selection.</p> <p>Button function with pressed <i>[SHIFT]</i> button:</p> <ul style="list-style-type: none">■ <i>[PIANO]</i> Calling Piano mode.■ <i>[METRONOME]</i> Turning the metronome on and off.■ <i>[DUAL]</i> Enabling / disabling right hand voice (R2).■ <i>[LOWER]</i> Enabling / disabling left hand voice (L).■ <i>[TOUCH]</i> Enabling default setting.■ <i>[DSP]</i> Turning digital effects on and off.■ <i>[TRANSDPOSE -/+]</i> Transposing the entire claviature up or down.
19	<p><i>[SCALE]</i></p> <p>Enables / disables the selection of historic tunings.</p>
20	<p><i>[OCTAVE]</i></p> <p>Button for octaving the keyboard in TWINOVA mode.</p>
21	<p><i>[TWINOVA]</i></p> <p>Enables / disables the TWINOVA mode.</p>
22	<p><i>[FREEZE] [HARMONY]</i></p> <p>Single button function: Calling Freeze mode.</p> <p>Button function with pressed <i>[SHIFT]</i> button: Calling Harmony mode.</p>
23	<p><i>[O.T.S.] [MELODY 5]</i></p> <p>Single button function: Enabling One Button Operation.</p> <p>Button function with pressed <i>[SHIFT]</i> button: Record enabling melody track 5.</p>
24	<p><i>[M1] ... [M4] [MELODY 1] ... [MELODY 4]</i></p> <p>Single button function: Calling user settings M1 ... M4.</p> <p>Button function with pressed <i>[SHIFT]</i> button: Record enabling melody tracks 1 ... 4.</p>
25	<p><i>[STORE] [ACCOMP]</i></p> <p>Single button function: Saving current values as user setting.</p> <p>Button function with pressed <i>[SHIFT]</i> button: Record enabling accompaniment track.</p>
26	<p><i>[BANK] [RECORD]</i></p> <p>Single button function: Selecting memory bank.</p> <p>Button function with pressed <i>[SHIFT]</i> button: Enabling Recording mode.</p>

- | | |
|----|--|
| 27 | [NO/-].
Decreases the displayed value by one. |
| 28 | [SONG] [ALBUM]
Single button function: Calling Song mode.
Button function with pressed [SHIFT] button: Calling Album mode. |

Rear panel connections

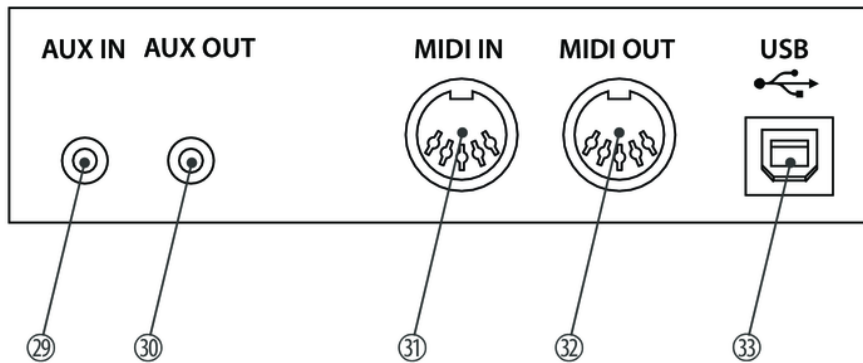

- | | |
|----|--|
| 29 | [AUX IN]
Input socket for connecting an external audio device (e.g. MP3 or CD player). |
| 30 | [AUX OUT]
Output socket for connecting the digital piano to an amplifier, stereo system, mixer or recording device. |
| 31 | [MIDI IN]
MIDI in for connecting an external MIDI device. |
| 32 | [MIDI OUT]
MIDI out for connecting an external MIDI device. |
| 33 | [USB]
USB interface to connect a computer. |

Display

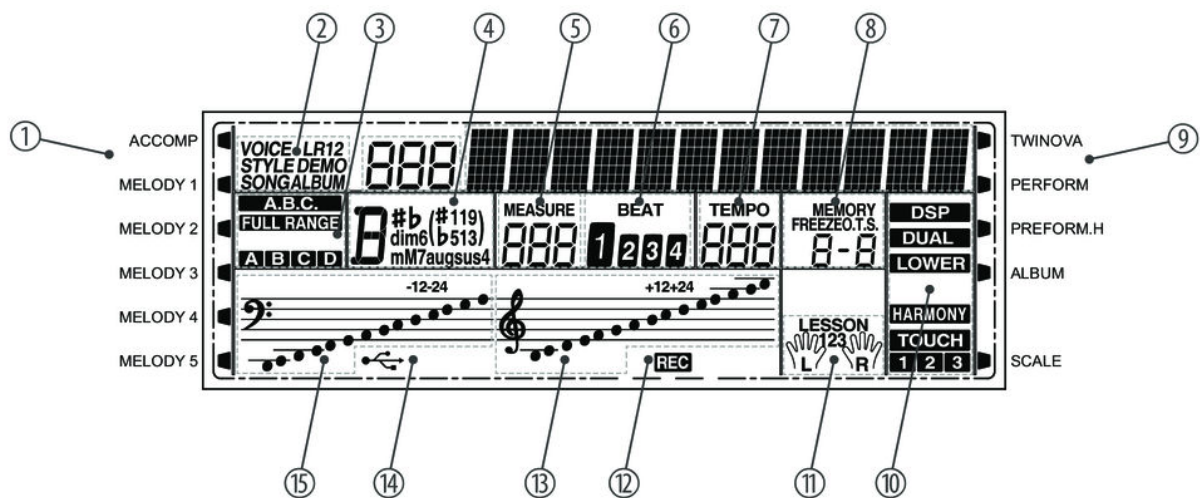

1	Accompaniment track / Melody track 1 ... 5	9	Operating mode TWINOVA, PERFORM, PERFORM.H, ALBUM, SCALE
2	Operating mode VOICE, STYLE, DEMO, SONG, ALBUM	10	Operating mode DSP, DUAL, LOWER, HARMONY, TOUCH
3	Chord detection, Full Range, Accompaniment track section	11	Lesson mode, left / right hand active
4	Chord	12	Record
5	Bar	13	Note in treble clef
6	Beat	14	USB connection
7	Tempo	15	Note in bass clef
8	Memory bank, memory location		

Piano keys

The keyboard keys are referred to in this manual as shown below.

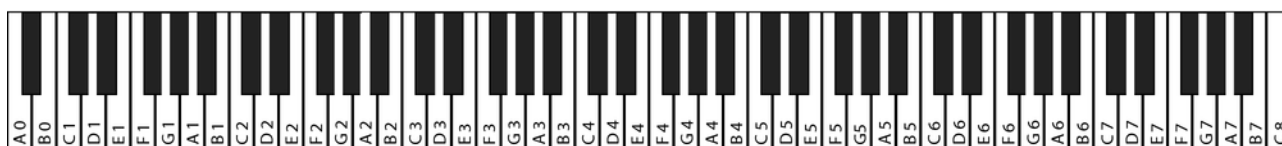

6 Connectivity options

Headphones

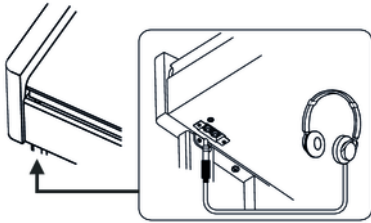

To the left beneath the keyboard you find the headphones outlets 1 and 2. Connecting headphones (not supplied) to outlet 2 mutes the speakers. Using outlet 1 maintains the sound output through the speakers.

Pedals

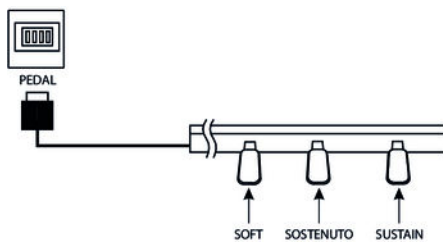

1. ➤ Connect the foot pedal to the provided connector on the bottom of the pedal box.
2. ➤ Pedal functions:

Soft pedal

Using the Soft pedal makes the piano sound smoother and the overall volume is attenuated.

Sostenuto pedal

When stepping on the Sostenuto pedal, the currently played notes linger until you release the pedal.

Sustain pedal

With the sustain pedal all played notes sound longer. This effect simulates the lifting of the damper in an analogue keyboard instrument.

Computer

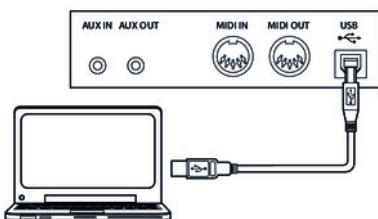

- USB port
The USB port provides data exchange with a computer.

MIDI port

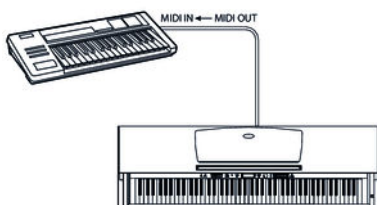

- MIDI connections
MIDI stands for 'Musical Instrument Digital Interface' and represents a global standard for the communication of numerous electronic instruments and sound modules.
 - MIDI IN: The device receives MIDI data from other devices through this port.
 - MIDI OUT: MIDI data generated by the digital piano is sent to other MIDI devices through this port.

External audio devices

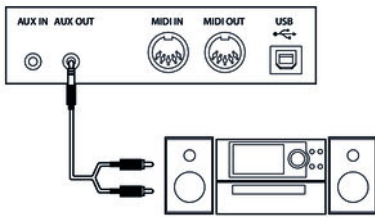

Via the socket *[AUX OUT]* you can connect the digital piano to an amplifier, stereo device, mixing console or recording device. Plug one end of the audio cable into the *[AUX OUT]* socket on the rear panel of the digital piano, and the other end into the input of the respective audio device.



NOTICE!

To prevent damage to the speakers, turn the volume down to 'Minimum' before you connect other devices to the digital piano.

MP3 / CD player

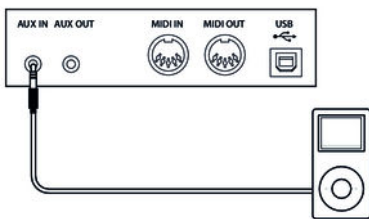

Via the socket *[AUX IN]* you can connect a, for example, CD or MP3 player to the digital piano. So you can playback music through the internal speakers of the digital piano and simultaneously play along to it. Plug one end of the audio cable into the *[AUX IN]* socket on the rear panel of the digital piano, and the other end into the output of the respective audio device.

7 Switching on / off, basic operation

7.1 Turning the digital piano on and off

7.1.1 Normal switching on / off



Press the power button on the right of the claviature to turn the device on and off.



If the display does not light up after switching on the digital piano, check the power supply.

If you hear nothing coming from the speakers, the volume may be set to 'minimum'.

7.1.2 Automatic shutdown

If the digital piano is not in use, it shuts off after 30 minutes automatically. For adjusting or disabling the automatic shutdown, please proceed as described here [Chapter 7.1.2 'Automatic shutdown' on page 23](#).

To turn the device on again after an automatic shutdown, press the on / off switch to the right of the claviature.

7.2 Setting up the digital piano, Function menu

Simultaneously press the buttons *[SHIFT]* and *[FUNCTION + | -]* to call the Functions menu. Select the desired sub menu using the buttons *[FUNCTION + | -]*. You can then change the following parameters using the jog dial or the buttons *[YES / +]* and *[NO / -]* ändern:

Option	LCD	Control range	Default value
Fine tuning	Tune	-50 ... 50	000
Split point	KeySplit	1 ... 88	034
Beats	BeatType	0, 2 ... 9	004
Metronome volume	MetroVol	0 ... 127	90
Pedal function	Pedal	Sust, St/T, Mem	Sust
Reverb volume	ReverbVol	0 ... 127	Depending on the selected voice
Chorus volume	ChorusVol	0 ... 127	Depending on the selected voice

Option	LCD	Control range	Default value
Selection Harmony setting	xxxx	Duet, Standard Trio, Full Chord, Rock Duet, Country Duet, Country Trio, Block, 4 Close 1, 4 Close 2, 4 Open, 1+5, Octave, Strum, Echo, Tremolo, Trill	Duet
Effects depth Harmony setting	HarmonySpeed	1 ... 4	1
MIDI receive channel	Midi In	1 ... 16, ALL	ALL
MIDI send channel	Midi Out	1 ... 16	001
Automatic shutoff	Power off	030, 060, OFF	030
Time signature	Perform Beat	4-4, 3-4, 2-4, 6-8	4-4



If you don't press any key within five seconds after entering the function menu, the menu is automatically closed.

7.2.1 Fine tuning

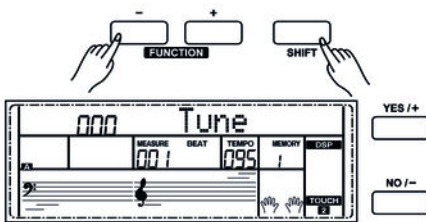

With this function you can fine tune the entire claviature in cent steps.

1. Use [FUNCTION + | -] to switch to 'Tune' menu. The current setting appears on the display.
2. Adjust the tuning using the buttons [YES / +] or [NO / -] or the jog dial in a range of -50 to +50 cents. Each time a key is pressed, the value changes by 1 cent.
3. Simultaneously press [YES / +] and [NO / -], to reset the tuning to the default value.

7.2.2 Split point

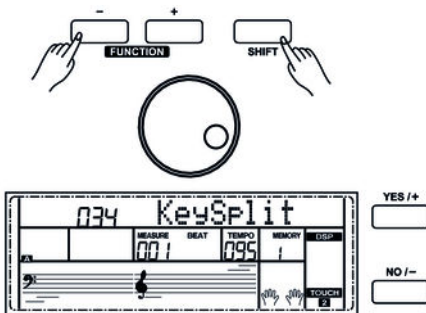

Using this function you can select a point to split the whole claviature into two areas.

1. Use [FUNCTION + | -] to switch to 'KeySplit' menu. The current setting appears on the display.
2. Set the desired split point using the buttons [YES / +] or [NO / -] or the jog dial. The keys to the right of this point are the right hand area, the keys of the other sides are the left hand area (chord area).
3. Simultaneously press [YES / +] and [NO / -] to reset the split point to the default value (F#3 / 034).

7.2.3 Beats

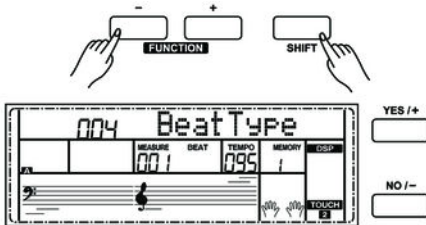

With this function you can set the beats in a range from 0 to 9.

1. Use [FUNCTION + | -] to switch to 'BeatType' menu. The current setting appears on the display.
2. Adjust the beat using the buttons [YES / +] or [NO / -] or the jog dial.
3. Simultaneously press [YES / +] and [NO / -] to reset the beat to the default value (004).

7.2.4 Metronome volume

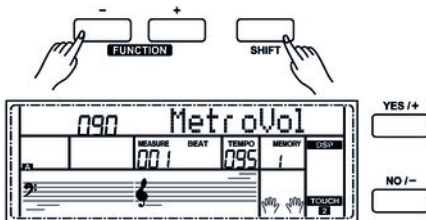

With this function you can set the metronome volume in a range from 0 to 127.

1. Use [FUNCTION + | -] to switch to 'MetroVol' menu. The current setting appears on the display.
2. Adjust the volume using the buttons [YES / +] or [NO / -] or the jog dial.
3. Simultaneously press [YES / +] and [NO / -] to reset the volume to the default value (090).

7.2.5 Pedal function selection

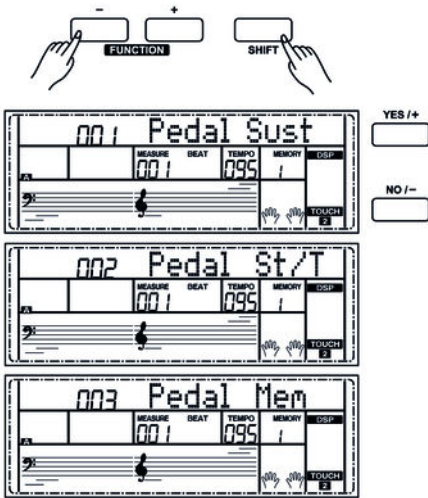

With this function you can assign the pedal function.

1. ➤ Use [FUNCTION + | -] to switch to 'Pedal' menu. The current setting appears on the display.
2. ➤ Use the buttons [YES / +] or [NO / -] or the jog dial to select the desired pedal function: 'Sust' (Sustain pedal), 'St/T' (enabling / disabling accompaniment track), 'Mem' (controlling storage function).
3. ➤ Simultaneously press [YES / +] and [NO / -] to reset the pedal function to the default value (Sust).

7.2.6 Reverb volume

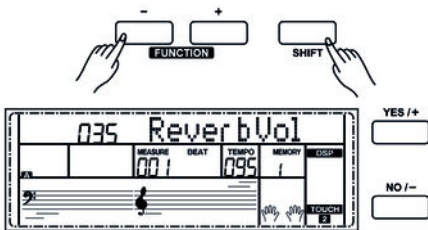

With this function you can set the Reverb effects volume in a range from 0 to 127.

1. ➤ Use [FUNCTION + | -] to switch to 'ReverbVol' menu. The current setting appears on the display.
2. ➤ Adjust the effects volume using the buttons [YES / +] or [NO / -] or the jog dial.
3. ➤ Simultaneously press [YES / +] and [NO / -] to reset the effects volume to the default value (depending on the selected voice).

7.2.7 Chorus volume

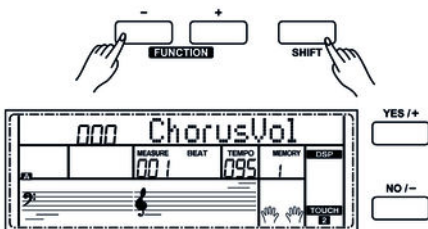

With this function you can set the Chorus effects volume in a range from 0 to 127.

1. ➤ Use [FUNCTION + | -] to switch to 'ChorusVol' menu. The current setting appears on the display.
2. ➤ Adjust the effects volume using the buttons [YES / +] or [NO / -] or the jog dial.
3. ➤ Simultaneously press [YES / +] and [NO / -] to reset the effects volume to the default value (depending on the selected voice).

7.2.8 Selecting a setting for the Harmony mode

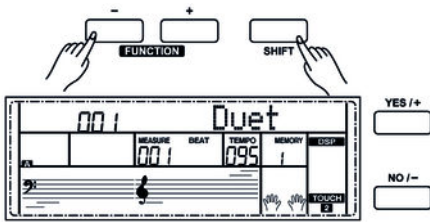

With this function you can determine a setting for the Harmony mode.

1. Use [FUNCTION + | -] to switch to Harmony type menu. The description of the current setting, e.g. 'Duet', appears on the display.
2. Use the buttons [YES / +] or [NO / -] or the jog dial to select the desired setting:

Number	Display
001	'Duet'
002	'Standard Trio'
003	'Full Chord'
004	'Rock Duet'
005	'Country Duet'
006	'Country Trio'
007	'Block'
008	'4 Close 1'
009	'4 Close 2'
010	'4 Open'
011	'1+5'
012	'Octave'
013	'Strum'
014	'Echo'
015	'Tremolo'
016	'Trill'

3. Simultaneously press [YES / +] and [NO / -] to load the default setting (Duet).

For the harmony settings Echo, Tremolo and Trill and you can also set the effects depth as described in the following section.

7.2.9 Effects depth in Harmony mode

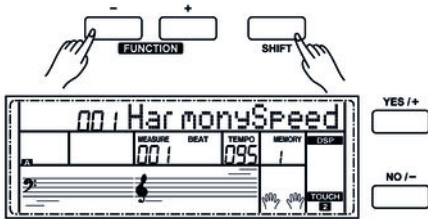

With this function you can determine the effects depth for the Harmony settings Echo, Tremolo and Trill.

1. Use [FUNCTION + | -] to switch to 'HarmonySpeed' menu. The current setting appears on the display.
2. Adjust the Effects depth using the buttons [YES/+] or [NO / -] or the jog dial.
3. Simultaneously press [YES/+] and [NO / -] to reset the effects depth to the default value (001).

7.2.10 Midi receive channel (Midi In)

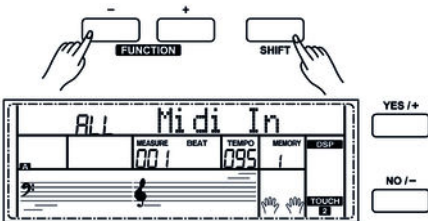

With this function you can determine on which channel the digital piano receives MIDI information from other devices.

1. Use [FUNCTION + | -] to switch to 'Midi In' menu. The current setting appears on the display.
2. Set the desired MIDI receive channel using the buttons [YES/+] or [NO / -] or the jog dial.
3. Simultaneously press [YES/+] and [NO / -] to reset the channel selection to the default value (ALL).

7.2.11 MIDI send channel (Midi Out)

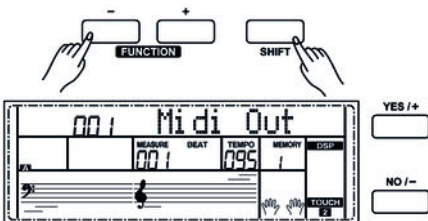

With this function you can determine on which channel the digital piano sends MIDI information to other devices.

1. Use [FUNCTION + | -] to switch to 'Midi Out' menu. The current setting appears on the display.
2. Set the desired MIDI send channel using the buttons [YES / +] or [NO / -] or the jog dial.
3. Simultaneously press [YES / +] and [NO / -] to reset the channel selection to the default value (001).

7.2.12 Automatic shutdown

With this function you can specify whether and after what time the automatic shutdown of the digital piano is carried out.

1. Use [FUNCTION + | -] to switch to 'Power Off' menu. The current setting appears on the display.
2. Use [YES / +] or [NO / -] or the jog dial to select one of the following options:
 - '030' (automatic shutdown after 30 minutes)
 - '060' (automatic shutdown after 60 minutes)
 - 'OFF' (automatic shutdown off).
3. Simultaneously press [YES / +] or [NO / -] to enable the default setting (automatic shutdown after 30 minutes).

7.2.13 Time signature

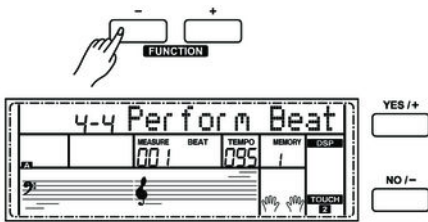

Use this function to determine a Time signature (4-4, 3-4, 2-4 or 6-8).

1. Use [FUNCTION + | -] to switch to 'Perform Beat' menu. The current setting appears on the display.
2. Adjust the Time signature using the buttons [YES / +] or [NO / -] or the jog dial.
3. Simultaneously press [YES / +] and [NO / -] to reset the Time signature to the default value (4-4).

7.3 Adjusting the volume



Use the rotary control [VOLUME] to set a comfortable volume for playing and practising. Turn this control clockwise to increase the volume. Turn it counter-clockwise to reduce the volume.

7.4 Setting the Brilliance

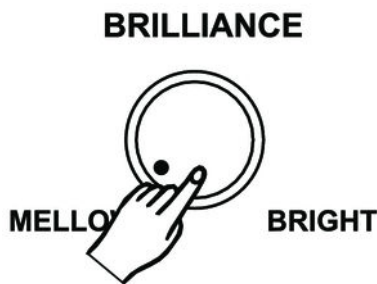

Use the rotary control *[BRILLIANCE]* to adjust the Brilliance of the digital piano. The sound of the entire keyboard range gets softer and darker when you turn the knob to the left, and brighter and more brilliant when you turn the knob to the right.

7.5 Transposing

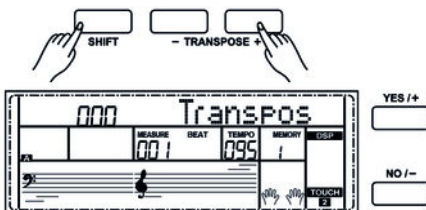

With this function you can adjust the pitch of the claviature in 12 semitone steps up or down.

1. ➤ Keep the button *[SHIFT]* pressed and adjust the pitch of the claviature using the buttons *[TRANSPOSE +/-]*.
2. ➤ Simultaneously press *[YES /+]* and *[NO /-]* to restore the default setting (no transposing).

7.6 Touch sensitivity

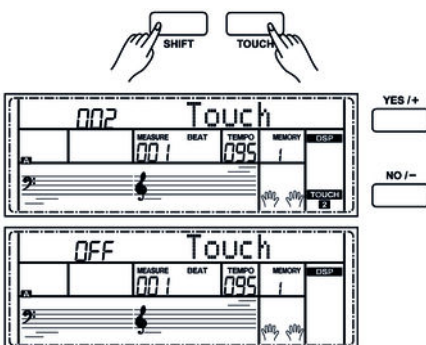

With this function you can adjust the touch response of the keyboard at four levels.

1. ➤ Simultaneously press the buttons *[SHIFT]* and *[TOUCH]* to open the menu for adjusting the touch sensitivity.
2. ➤ Adjust the Touch sensitivity using the buttons *[YES /+]* and *[NO /-]* or the jog dial.
3. ➤ Simultaneously press *[YES /+]* and *[NO /-]* to restore the default setting (002).

Parameter	Description
'OFF'	Touch sensitivity is off. This can be very recommendable when playing the organ voice.
'001'	Soft In this setting, the volume is higher than usual even when playing with a soft touch.
'002'	Normal This setting corresponds to the usual touch response of a keyboard.
'003'	Hard In this setting, the volume is lower than usual even when playing with a hard touch.

7.7 DSP effects depth

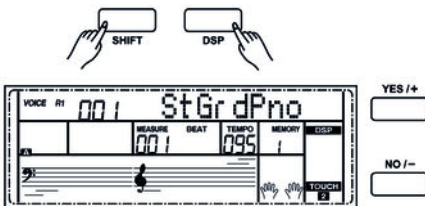

This function lets you change the intensity of the Reverb and Chorus effects.

1. This function is enabled by default when the digital piano is turned on. The DSP indicator lights up on the display.
2. Simultaneously press the buttons *[SHIFT]* and *[DSP]* to turn the function off and back on again.

7.8 Factory defaults

Proceed as follows to restore the factory default settings:

1. Turn off the digital piano.
2. When turning back on, keep the buttons *[YES / +]* and *[NO / -]* pressed.
 - ⇒ All user songs and settings are reset or deleted without further confirmation prompt. The display shows 'Wait ...!'.

8 Operating

8.1 Demo songs

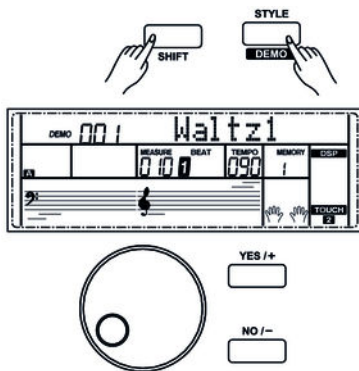

The digital piano offers a total of two demo songs.

1. ➤ Simultaneously press the buttons [SHIFT] and [DEMO] to enter the DEMO mode. The first demo song is displayed and the both demo songs will be played in a endless loop.
2. ➤ During playback, you can use the buttons [+ / YES] and [- / NO] or the jog dial to change between both demo songs.
3. ➤ Press the button [START / STOP] to stop playback.
4. ➤ Simultaneously press the buttons [SHIFT] and [DEMO] to exit the DEMO mode.



In DEMO mode, only the buttons [SHIFT], [DEMO], [START / STOP], [+ / YES] and [- / NO], [VOLUME] and [BRILLIANCE] as well as the jog dial are available. All other buttons are disabled.

8.2 Practise songs

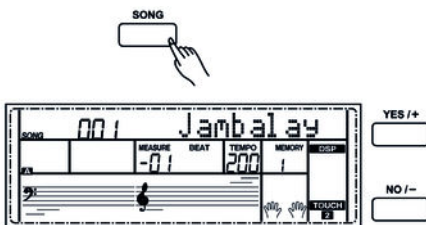

The digital piano offers 60 practise songs, where you can mute the right hand voice and play this part yourself.

1. ➤ **Playing and stopping practise songs**
Press the button [SONG] to switch to Practise song playback mode. 'SONG' appears on the display and all practise songs are being played in an endless loop.
Press the button [START / STOP] again to stop the currently playing practise song. This will not quit the mode for rehearsal song playback 'SONG'.
2. ➤ **Single loop**
If you again press the button [START / STOP] again the current song will be repeated in an endless loop until you press the button [START / STOP] again.
3. ➤ **Selecting a practise song**
Use the jog dial or the buttons [+ / YES] or [- / NO] to select the desired practise song. If you select a new practise song, the display shows first the title in running text, then the abbreviation.



4. Playback control

Pre-count

One bar will be pre-counted before playback begins. The bar display starts with a negative value. The practise song starts with bar 1.

Fast-forward, rewind, pause

Keep the ►► pressed during playback to fast-forward the practise song. Use the ◀◀ button to rewind bar by bar. Press the ■ button to pause playback.

Repeat function

While the practise song is being played, you can set two loop marks with the ⇄ button. Press the button at the desired start point of the loop and again at the end point.

5. To exit practise song playback press any direct select or function button.

Lesson mode

When practising, it is especially important to play the right **notes** at the right **time**. In this mode you can check your progress. Press the button [LESSON] in SONG mode to enable the lesson mode. There are three training stages. With the buttons [R] and [L] you can specify the hand you want to practise. If you don't select a hand, the right hand will automatically be selected.

Lesson 1 - playing in time

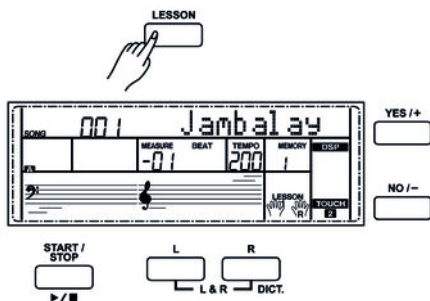

Press the button [LESSON] to call the lesson mode. 'LESSON 1' appears on the display. In this mode, it is only rated whether you play the notes at the right time, but not whether you hit the right notes.

1. Press the button [START / STOP] to start practising.

2. If you have selected 'R' the right hand voice is muted and you have to play the right hand yourself. As long as you are in time, you will hear the right hand voice. If you have selected 'L' the left hand voice is muted and you have to play the left hand yourself. As long as you are in time, you will hear the left hand voice. Are both 'L' and 'R' selected the voices for both hands are muted. You then have to play in time with both hands.

3. After completing the exercise, you will learn the result.

Lesson 2 - hitting the right notes

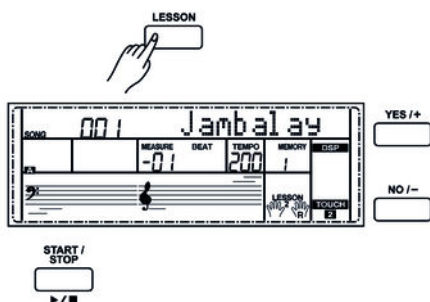

Press the button [LESSON] to call the lesson mode 2. 'LESSON 2' appears on the display. In this mode, it is only rated whether you hit the right notes, but not whether you play them at the right time. The rehearsal song continues only when you play the right note.

1. ➤ Press the button [START / STOP] to start practising.
2. ➤ After completing the exercise, you will learn the result.

Lesson 3 - hitting the right notes at the right time.

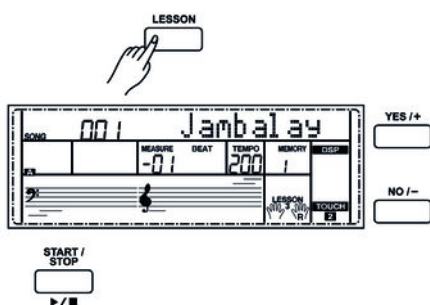

Press again the button [LESSON] to call the lesson mode 3. 'LESSON 3' appears on the display. In this mode, it is rated whether you play the right notes at the right time. The rehearsal song continues only when both is correct.

1. ➤ Press the button [START / STOP] to start practising.
2. ➤ After completing the exercise, you will learn the result.

8.3 Metronome

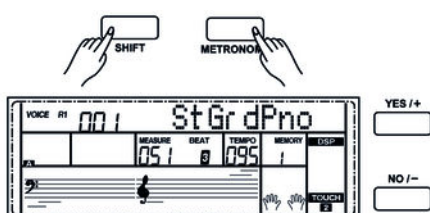

Simultaneously press the buttons [SHIFT] and [METRONOME] to turn the metronome on or off. You can select the beat in the functions menu.

If the Style mode is disabled, the beat set in the function menu is applied after turning on the metronome. If the Style mode is enabled, the beat of the current style is applied.

The metronome can be activated along with the style. If the style plays first, the metronome will be enabled with the next bar. On the other hand, the metronome responds instantly to the first beat of the style.

8.4 Piano mode

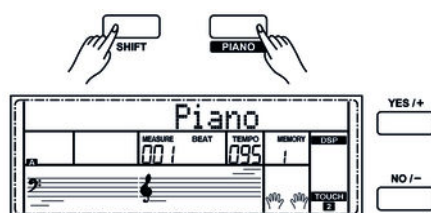

Simultaneously press the buttons [SHIFT] and [PIANO] to enable the normal piano playing mode. The entire keyboard sounds with the piano voice.

8.5 Dual mode

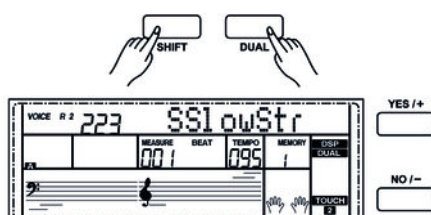

In Dual mode, you can play two voices simultaneously.

1. ➤ Simultaneously press the buttons [SHIFT] and [DUAL] to enable the DUAL mode. The indicators 'VOICE R2' and 'DUAL' then light simultaneously on the display. The number and the name of the voice R2 appear on the display.
2. ➤ Selecting another dual voice is carried out via direct select buttons, buttons [+ / YES] and [- / NO] or the jog dial.
3. ➤ Press the button [DUAL] again to exit Dual mode. 'VOICE R2' is being disabled and you only hear the voice set for 'VOICE R1'. The indicators 'VOICE R2' and 'DUAL' turn off.



When the keyboard is split, the Dual mode affects only the keys to the right of the clavature split point. In the area to the left of the split point, chords are supposed to be played.

8.6 Split mode

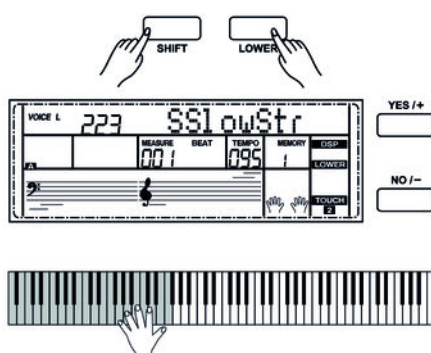

With this function, you can assign different voices to certain keyboard areas.

1. ➤ Simultaneously press the buttons [SHIFT] and [LOWER] to enable the SPLIT mode. The indicators 'VOICE L' and 'LOWER' then light simultaneously on the display. The number and the name of the left hand voice appear on the display.
2. ➤ Press the buttons [+ / YES] or [- / NO] or turn the jog dial to select a desired voice for the left hand.
3. ➤ Simultaneously press the buttons [SHIFT] and [LOWER] to exit Split mode. The indicators 'VOICE L' and 'LOWER' turn off.



The right hand voice is not affected by the selection for the left hand voice.

8.7 TWINOVA

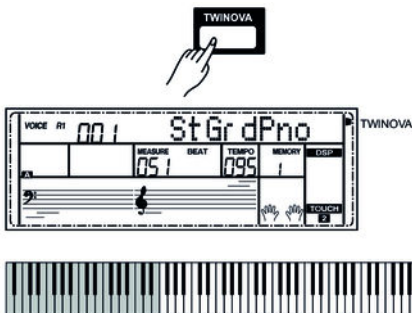

In TWINOVA mode, the keyboard is divided into two areas with the same voice and the same pitch.

1. Voice selection

First, select the desired voice (see [Chapter 8.8 'Selecting voices' on page 36](#)).

2. Enabling TWINOVA

Press the button [TWINOVA] to switch to TWINOVA mode. The LED 'TWINOVA' lights.

3. Split point setting

See .

4. Octave area setting

Press the button [OCTAVE]. The display shows the current setting. Adjust the octave range using the buttons [+ / YES] or [- / NO] or the jog dial.

8.8 Selecting voices

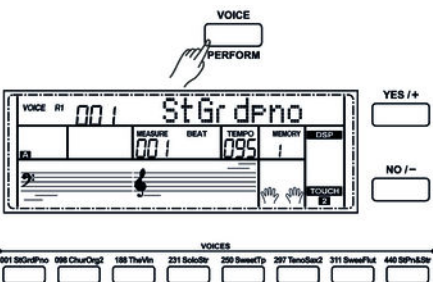

The digital piano offers 500 voices in total.

- Press the button [VOICE] or one of the direct select buttons in the [VOICES] area to enable the VOICE mode. 'VOICE R1' then lights on the display. The number and the name of the currently assigned right hand voice appear on the display.
- To select other voices press one of the direct select buttons, the buttons [+ / YES] or [- / NO] or rotate the jog dial.



If you enable the VOICE mode using the [VOICE] button 'R1' (right hand voice) appears on the display. Repeatedly press the [VOICE] button to successively enable the modes 'R2' (second right hand voice in Dual mode), 'L' (left hand voice) and again 'R1' (right hand voice).

8.9 Harmony mode

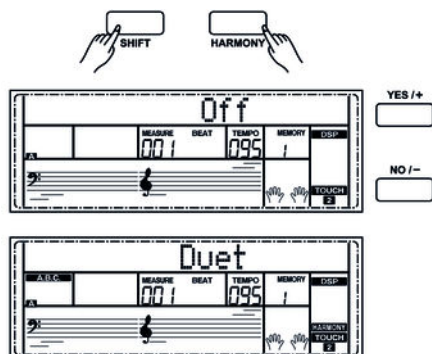

In harmony mode, appropriate harmonic frequencies are automatically added to the notes played.

1. ▶ Enabling Harmony mode

Simultaneously press *[SHIFT]* and *[HARMONY]* to switch to Harmony mode. The display shows the standard value 'Off'.

2. ▶ Preset selection

See

8.10 Playing with accompaniment

The digital piano offers a total of 200 Styles. By default, Style '001' is set.

8.10.1 Style selection

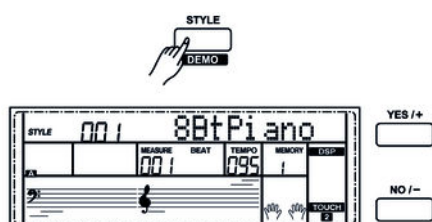

1. ▶ Press the button *[STYLE]* or one of the direct select buttons in the *[STYLES]* area to enable the STYLE mode. 'STYLE' then lights on the display. The number and the name of the current Style appear on the display.

2. ▶ To select other Styles press one of the direct select buttons, the buttons *[+/YES]* or *[-/NO]* or rotate the jog dial.

8.10.2 Playing Styles, Chord mode

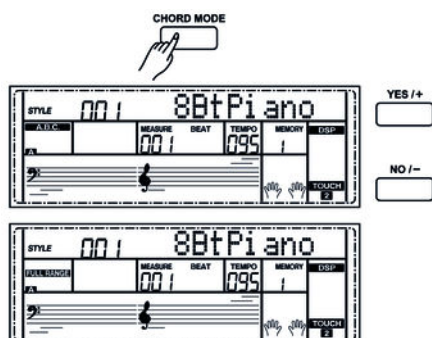

1. ▶ Instant start

Press the button *[START / STOP]* to start the Style.

2. ▶ Chord mode

Press the button *[CHORD MODE]* once to enable the Single Finger mode. The LED 'A.B.C.' lights. The area to the left of the split point is now regarded as the chord area. If you play a chord with one finger, bass and chord sound simultaneously.

Press the button *[CHORD MODE]* twice to enable the FULL RANGE mode. The 'FULL RANGE' LED lights. The chord area now covers the entire claviature.

3. SYNC START

Press the button [SYNC START] to enable the Sync Start mode. When you now press one of the piano keys in the chord area, Style accompaniment starts synchronously. Accompaniment is being automatically adjusted on chord changes.

8.10.3 Tempo

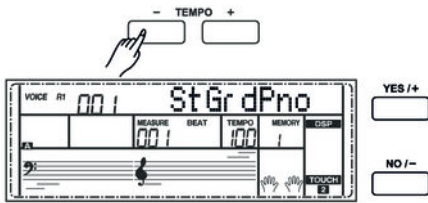

All preprogrammed Styles contain certain Tempo information. These presets can be adjusted at any time.

- 1.** Press the buttons [TEMPO+]/[TEMPO-] or rotate the jog dial to adjust the tempo of a style.
- 2.** Press the buttons [TEMPO+]/[TEMPO-] simultaneously to reset the tempo to the preset default value.



- When Style is not activated, the tempo is automatically changed along with the style to the default value.
- When Style is activated, the tempo is not changed by the style you select.

8.10.4 Mixer

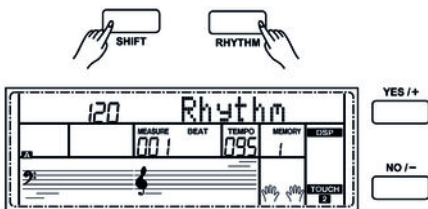

This menu is used to adjust the volume of the various style elements.

- 1.** Simultaneously press the buttons [SHIFT] and [RHYTHM] to open the Mixer menu. The display shows the option 'Rhythm' and the current volume of the element.
- 2.** Adjust the volume using the buttons [+ /YES] or [- /NO] or the jog dial in a range of 0 ... 127.
- 3.** Repeatedly press the buttons [SHIFT] and [RHYTHM] to successively call the options 'Bass', 'Chord', 'Lower' and 'Upper'. The display shows the currently active option and the volume of the element.
- 4.** Adjust the volume respectively using the buttons [+ /YES] or [- /NO] or the jog dial in a range of 0 ... 127.

8.11 Auto Accompaniment

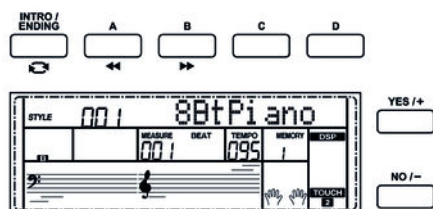

The accompaniment function is controlled via four parameters: INTRO, MAIN (A, B, C, D), FILL (A, B, C, D) and ENDING.

1. ▶ INTRO

Press the button *[INTRO / ENDING]* before you start to play to insert an intro. Depending on the selected Style the rhythm starts with two to four bars, followed by the main part.

2. ▶ MAIN (A, B, C, D)

The main part consists of an accompaniment pattern with different sections and is repeated until you enter a new song section (FILL or ENDING). The individual sections of the main part are selected via the buttons *[A]*, *[B]*, *[C]* and *[D]* angewählt.

3. ▶ FILL (A, B, C, D)

Via the buttons *[A]*, *[B]*, *[C]* and *[D]* you can insert four different fill bars.

4. ▶ ENDING

If you press the button *[INTRO / ENDING]* while Auto Accompaniment is activated, an ending part matched to the accompaniment is inserted and the performance ends.

8.12 Accompaniment track volume, muting

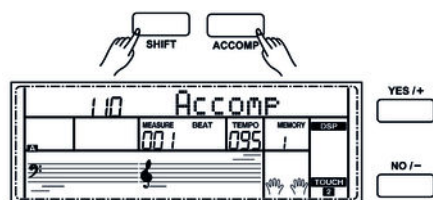

1. ▶ Simultaneously press the buttons *[SHIFT]* and *[ACCOMP]*. The display shows the current volume setting of the accompaniment track.

2. ▶ Adjust the accompaniment track volume using the buttons *[YES / +]* and *[NO / -]* or the jog dial in a range of 0 ... 127.

3. ▶ If you press the buttons *[YES / +]* and *[NO / -]* simultaneously the accompaniment track is being muted.

4. ▶ Press the buttons *[YES / +]* and *[NO / -]* simultaneously again to unmute the accompaniment track.

8.13 Performance Assistant

The 'Performance Assistant' is a playing aid, which allows you to simulate different instruments on the claviature.

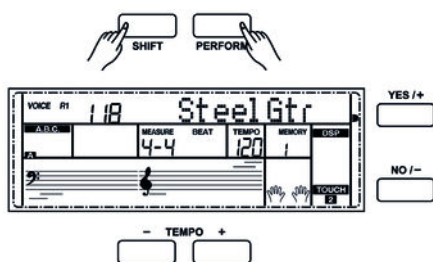

1. ➤ Simultaneously press the buttons *[SHIFT]* and *[PERFORM]* to enable the playing aid.
GUITAR mode is enabled by default. Use the buttons *[YES / +]* and *[NO / -]* or the jog dial to select a voice.
2. ➤ Adjust the Tempo using the buttons *[TEMPO +]* and *[Tempo -]* to adapt the values).
3. ➤ Adjust the time signature as described under .

8.13.1 GUITAR mode

In this mode, you can simulate a guitar sound on the claviature. The table shows the various play areas.



Chord area A

This area includes the keys A0 to B3 of the claviature.

The chord type appears in the display. The root of the guitar chord sounds.

Area B1

This area includes the white keys C4 to B4 of the claviature.

Once the chord type is displayed, you can play several figures of broken chords with the white keys in this area. While playing, you also have the possibility to vary the chord played in the chord area.

Area B2

This area includes the white keys C5 to A6 of the claviature.

Once the chord type is displayed, you can play a solo track with the white keys in this area. While playing, you also have the possibility to vary the chord played in the chord area.

Rhythm area C

This area includes the white keys C6 to G6 of the claviature.

Once the chord type is displayed, you can play a rhythm track with the white keys in this area. While playing, you also have the possibility to vary the chord played in the chord area.

Shift D

Key C7. Press this button to shift upwards.

With keys A6 or B6, you have the opportunity to complete a phrase with a suitable ending.

While playing, you can generate various reverb effects with the black keys in the areas B1 and B2.

8.13.2 PIANO mode



After enabling the playing aid, use the [YES / +] or [NO / -] buttons or the jog dial to switch to the PIANO mode.

In this mode, the entire claviature sounds with the piano voice. The table shows the various play areas.



Play basic chords in area A and an accompanying melody in areas B and C an.

Keys A6, B6 and C7 give you the opportunity to complete a phrase with a suitable ending.

8.13.3 TRADITIONAL CHINESE INSTRUMENTS mode



After enabling the playing aid, use the [YES / +] or [NO / -] buttons or the jog dial to switch to the TRADITIONAL CHINESE INSTRUMENTS mode.

In this mode, you can simulate five different traditional Chinese instruments: 'Gu Zheng', 'Pi Pa', 'San Xian', 'Yang Qin' and 'Zhong Ruan'. The table shows the various play areas.



Play basic chords in area A and an accompanying melody in areas B and C an.

Gu Zheng

Use C7 to switch to Fast-Arpeggio mode. The 21 keys from C4 to B6 then simulate the strings of the Gu Zheng with the following tuning: C, D, E, G, A, c1, d1, e1, g1, a1, c2, d2, e2, g2, a2, c3, d3, e3, g3, a3, c4. Press key C7 again to exit the mode.

8.14 Chord detection

By default, the 'Auto Bass Chord' is disabled. Press the button [CHORD MODE] to enable this 'A.B.C.' function. The area to the left of the split point is already known as the chord area. When you now play a chord, both bass and chord voices will sound together.







As the A.B.C. chord detection is based on the root note of the chord, some chords that could be played according to the chord dictionary can not be detected by A.B.C., such as B6, B_b6, B_b6(9), B6(9), Baug, B_baug, B_bm6, Bm6, Adim7, B_bdim7, Bdim.

Two ways to detect a chord: Single and multi-finger mode.

If the chord is played on base of the illustration for multi-finger chords below, it will be detected as a 'multi-fingered' chord. If not, it will be detected as a 'single-finger' chord.

■ Single-finger chords

With this method, you can play chords with only one, two or three fingers within the capabilities of the auto accompaniment. Here we show you some examples of single finger chords (C, Cm, C7 and Cm7).

	To play a major chord Press the root note of the chord
	To play a minor chord Press the root note together with the nearest black key to the left of it .
	To play a seventh chord Press the root note together with the nearest white key to the left of it .
	To play a minor seventh chord Press the root notes together with the nearest white and black keys to the left of it (three keys altogether) .



When the A.B.C. function is activated, press the keys to the left of the split point. The chords are detected as single-finger chords.

■ Multi-finger chords

With this method, you can play chords with normal fingering within the capabilities of the auto accompaniment. Here we show you 32 chords using the example of C chords.

0 C 	1 C ₆ 	2 C _{M7} 	3 C _{M7} (#11) 	4 C _M (9) 	5 C _{M7} (9)
6 C ₆ (9) 	7 C _{aug} 	8 C _m 	9 C _{m6} 	10 C _{m7} 	11 C _{m7} (b5)
12 C _m (9) 	13 C _{m7} (9) 	14 C _{m7} (11) 	15 C _m M ₇ 	16 C _m M ₇ (9) 	17 C _{dim}
18 C _{dim7} 	19 C ₇ 	20 C _{7sus4} 	21 C ₇ (b5) 	22 C ₇ (9) 	23 C ₇ (#11)
24 C ₇ (b13) 	25 C ₇ (b9) 	26 C ₇ (13) 	27 C ₇ (#9) 	28 C _{M7} _{aug} 	29 C ₇ _{aug}
30 C _{sus4} 	31 C ₁₊₂₊₅ 	The notes in brackets are optional; the chords will also be recognised without them.			

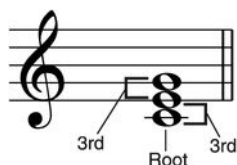

Major third – four half steps (semitones)

Minor third – three half steps (semitones)



■ Chord basics

A chord consists of three or more notes played together. The most commonly used chord is the triad consisting of three notes: Root, third and fifth of the corresponding scale. The C major chord for example is formed from the notes C (root), E (the third note of the C major scale), and G (the fifth note of the C major scale). In the C major chord shown, the lowest note is the root (this is the basic form of the chord - if you play other notes of the chord as the lowest note, this is called 'chord inversion'). The root is the central sound of the chord on which the other chord notes are built upon. The interval between adjacent notes and the root determines whether the result is a major or minor third.

■ Chord structure

The lower interval in our triad (between root and third) determines whether the result is a major or minor triad. In addition, we can shift the highest note by a half step up or down to produce two additional chords.

The basic characteristic of the triad remains even if we change the order of the notes to create different inversions. Consecutive chords can be softly connected in a chord progression, e.g. by choosing suitable chord inversions (also called 'voicings').

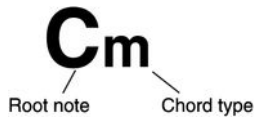

<p>Major chord</p>	<p>Minor chord</p>	<p>Augmented chord</p>	<p>Diminished chord</p>
---------------------------	---------------------------	-------------------------------	--------------------------------

■ Chord names

Chord names will tell you everything you need to know about a chord. Through the chord name, you know the root, whether it is a major, minor, or diminished chord, whether a large or flatted seventh is needed and what changes or tensions are used - all at a glance.

■ Some chord types

<p>Suspended 4th</p>	<p>7th</p>	<p>Minor 7th</p>	<p>Major 7th</p>
<p>Minor/major 7th</p>	<p>7th, flatted 5th</p>	<p>Minor 7th, flatted 5th</p>	<p>7th, suspended 4th</p>

8.15 Historic tunings

With this function, you can experiment with different historical tunings when playing certain musical genres that have not been composed based on equal temperament.

1. ➤ Press the button [SCALE] to switch to Historic Tunings mode. 'SCALE' lights.
2. ➤ Keep the button [SCALE] pressed to open the selection of historic tunings.
Once the 'SCALE' display flashes, you can use the buttons [YES / +] and [NO / -] to select one of the following settings: Pythagoras, pure major, pure minor, middle tone, Werckmeister or Kirnberger.
3. ➤ Use piano buttons C7 ... B7 to select the root of the selected tuning.
4. ➤ Press again [SCALE] to exit the Historic Tunings mode.

8.16 One Touch Setting

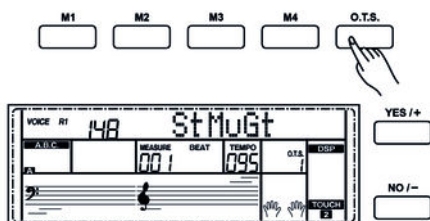

One Touch Setting (O.T.S. or one-key operation) is a convenient function that allows you to immediately reconfigure all settings with just one single key press. This is about rhythm-based compilations of instrument voices. With this function, four parameter types (M1 to M4) can be loaded.

1. ➤ Press the button [O.T.S.] to start this mode. Press one of the buttons [M1] to [M4,] then the device loads the corresponding parameter types that match the current Style. The ABC mode is automatically turned on at that.
2. ➤ Press one of the buttons [M1] to [M4] that provides your desired settings.
3. ➤ Press the button [O.T.S.] to exit O.T.S. mode.
4. ➤ The default parameters stored in O.T.S. are:
 - Voice R1, R2, L on / off
 - Change voice R1, R2, L
 - Volume R1, R2, L
 - Chorus level voice R1, R2, L
 - Reverb level voice R1, R2, L

8.17 Record, playback, delete

The digital piano lets you record three user songs that can contain six tracks each (one accompaniment track and five melody tracks).

8.17.1 Song recording

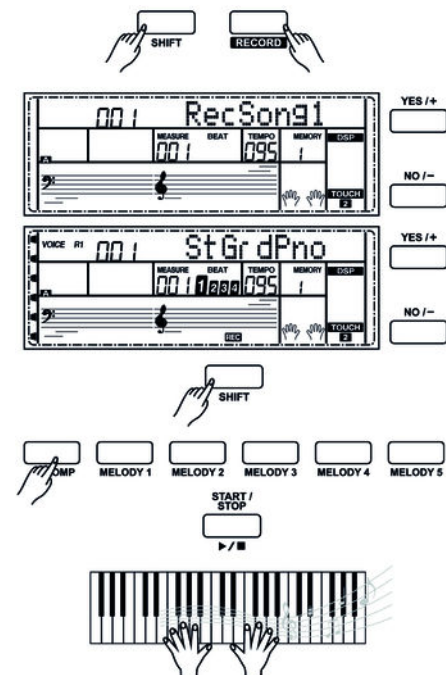

1. ➤ Simultaneously press the buttons [SHIFT] and [RECORD] to select a song. The display shows 'RecSong1' and the current memory location.
2. ➤ Use the buttons [+ / YES] or [- / NO] or the jog wheel to select a free memory location for the recording.
3. ➤ Record stand-by

Press again the buttons [SHIFT] and [RECORD] to enable the Recording mode. 'REC' lights up in the display. At the same time a free track for recording is automatically selected and the corresponding track display ([MELODY 1] to [MELODY 5] or [ACCOMP]) flashes. The tracks are selected in order [MELODY 1] to [MELODY 5], [ACCOMP]. If no free track is available, [MELODY 1] is selected. Press one of the buttons [MELODY 1] to [MELODY 5] or [ACCOMP] to select the track you want to record to.

4. ➤ Start recording

Press the button [START / STOP] on the record enabled digital piano to start recording.



When you start recording, you may overwrite data on the selected track.

5. ➤ Selecting tracks

As you select tracks the buttons can have three different states: They flash, are lit or off.

- A **flashing** button indicates that the track has been selected for recording.
- A **lit** button indicates that this track already contains data. These data will be played during recording to another track.
- If a button is **not lit** there is no data on this track or there is data that is not going to be played during recording.

Press one of the buttons [MELODY 1] to [MELODY 5] or [ACCOMP] to select the desired track. The corresponding track is then enabled with the condition described above.



- *You can only record one melody track at a time. However, you can record the accompaniment track along with one of the melody tracks.*
- *A style can only be recorded if it is activated by the [ACCOMP] button.*

6. ➤ Stopping recording

Press again the buttons [SHIFT] and [RECORD] to stop recording. If you're recording an accompaniment track press the button [INTRO / ENDING] to stop recording after the ending part. When the memory is full the recording stops automatically. In this case, 'Rec_Full' appears on the display.

8.17.2 Playback recordings

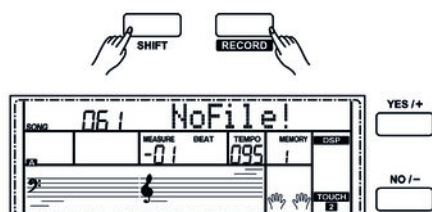

1. ➤ After recording, simultaneously press the buttons *[SHIFT]* and *[RECORD]*. The digital piano changes to Song mode, the last recording is automatically played as a loop.
2. ➤ Press the button *[SONG]* to play all songs in an endless loop, or use the buttons *[+/YES]* and *[-/NO]* to select a certain song for playback.
3. ➤ Press the button *[PLAY / STOP]* to stop playback.



If no recording is present and you press the *[PLAY / STOP]* button, 'NoFile!' briefly appears on the display.

8.17.3 Delete recording

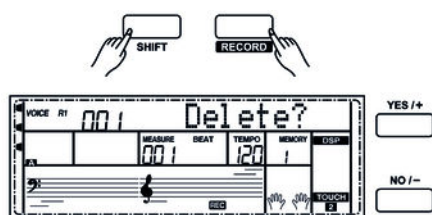

1. ➤ Deleting individual sections of the current recording.
Keep the buttons *[SHIFT]* and *[RECORD]* simultaneously pressed for two seconds. Simultaneously press *[SHIFT]* and *[ACCOMP]* or *[MELODY 1 ... 5]* to delete the accompaniment track or one of the melody tracks of the recording. The indicator of the selected track lights on the display. The confirmation prompt 'Delete?' appears on the display. Confirm with *[+/YES]*.
2. ➤ Deleting a single recording
Use the buttons *[+/YES]* or *[-/NO]* in Song mode to select the recording you want to delete. Confirm the confirmation prompt with *[+/YES]*. With *[-/NO]* you cancel the deleting.
3. ➤ Deleting all recordings
Turn off the digital piano. Simultaneously press the buttons *[RECORD]* and *[SONG]* and switch the digital piano back on again. All user recordings are going to be deleted without a prompt.

8.18 Memory

You can store 32 control panel configurations in the memory of the digital piano and recall the data any time, if required.

8.18.1 Memory banks

A total of eight memory banks are available, each with four memory locations (M1 to M4).

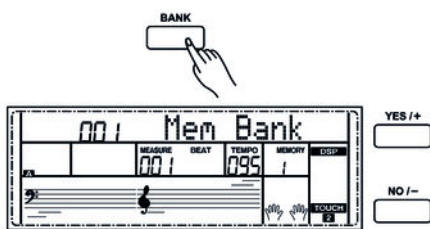

1. ➤ Press the button [BANK]. 'Mem Bank' appears on the display.
2. ➤ Use the jog dial or the buttons [+ / YES] or [- / NO] to select the desired memory bank.

8.18.2 Load / save parameters

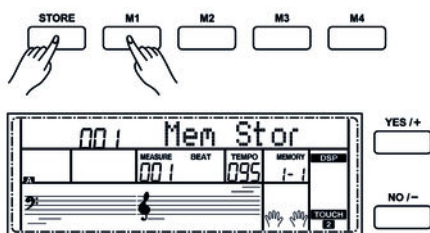

1. ➤ Keep the button [STORE] pressed and simultaneously press one of the buttons [M1] to [M4]. The current settings are then stored in the respective memory location (M1 to M4). Please note that any data previously stored there will be deleted.
2. ➤ Press one of the buttons [M1] to [M4]. The saved settings are then loaded from the corresponding memory and replace the current settings thereby.

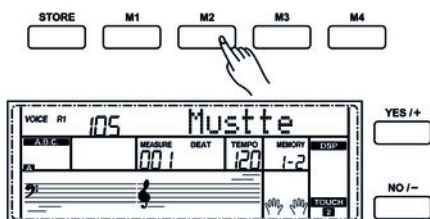

In O.T.S. mode, no settings can be loaded from the device memory.

8.18.3 Lock function

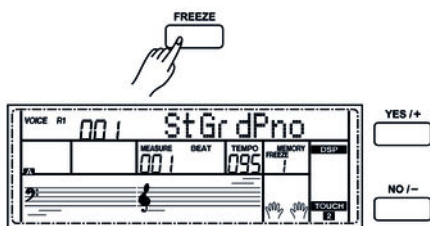

With the locking function, you can prevent the digital piano's current settings for rhythm and tempo from being overwritten with saved settings.

1. ➤ Press the button [FREEZE] to enable the locking function. 'FREEZE' lights up on the display.
2. ➤ Press the button [FREEZE] to disable the locking function. The 'FREEZE' display turns off.

8.19 Song album

The digital piano offers a song album with a total of 120 stored songs. When you call a song from the album all relevant supporting parameters are loaded automatically.

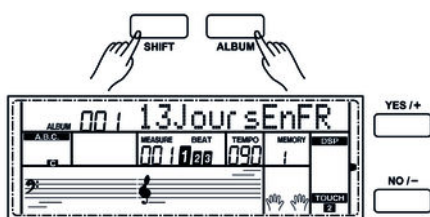

1. Simultaneously press the buttons [SHIFT] and [FUNCTION +/-] to open the song album.
2. Use the buttons [+ / YES] or [- / NO] to select the desired song.
3. To close the song album press one of the direct select buttons [VOICE] or [STYLE].

8.20 Chord dictionary

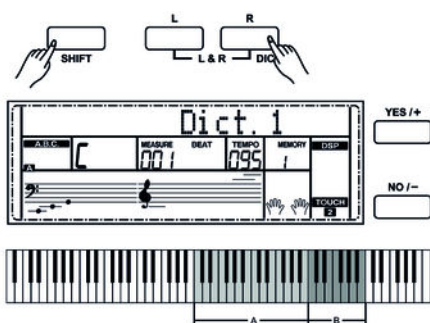

The Chord dictionary is basically a built-in 'Chord book' assisting you to find the right tones of a chord if you e.g. know only the chord name, but not how to play it.

1. DICT 1 (chord learning mode)

Simultaneously press the buttons [SHIFT] and [DICT.] to call the 'DICT.1' mode. In this mode, the keys from C4 on are used to assign the chord type, and the keys from C6 to assign the root note. If you have pressed the keys for chord type and root note, the display shows the chord name and the individual notes in the notation system.

For example, If you want to play a Cm7 chord, press the C6 key (root note C in the Cm7 chord). You will hear no sound, but the root note is displayed.

Press the A4 key (chord type for minor-seventh chord, 'm7'). You will hear no sound, but the chord name and the notes you should play for the specified chord appear in the display.



2. DICT 2 (chord testing mode)

Simultaneously press again the buttons [SHIFT] and [DICT.] to call the 'DICT.2' mode. The display shows a randomly generated chord name, but not its individual notes in the notation system. If you play the right chord within three seconds, the next randomly generated chord name appears. If this does not happen, the individual notes of the chord in the notation system appear automatically in the display.

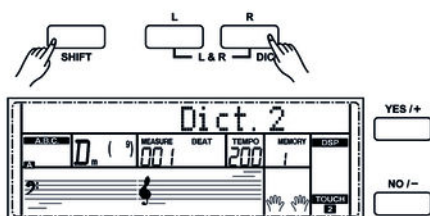

In the chord dictionary, the 12 root notes and 24 chord types are presented as follows:

Key names	Root note	Key names	Root note
C6	C	F#6	F#/G _b
C#6	C#/D _b	G6	G
D6	D	A _b 6	G#/A _b
E _b 6	D#/E _b 6	A6	A
E6	E	B _b 6	A#/B _b
F6	F	B6	B

Key names	Chord type	Key names	Chord type
C4	M	C5	7 _b 9
C#4	M(9)	C#5	7(9)
D4	6	D5	7(#9)
E _b 4	mM7	E _b 5	7 _b 13
E4	M7	E5	7(13)
F4	m	F5	7(#11)
F#4	m(9)	F#5	dim7
G4	m6	G5	dim
A _b 4	m7(9)	A _b 5	7aug
A4	m7	A5	aug
B _b 4	m7 _b 5	B _b 5	7sus4
B4	7	B5	sus4

8.21 MIDI functions



MIDI stands for ‘Musical Instrument Digital Interface’ and represents the standard interface between a computer and electronic instruments.

You can exchange MIDI data with other MIDI devices via the MIDI and USB interfaces of the digital piano.

8.22 USB connection

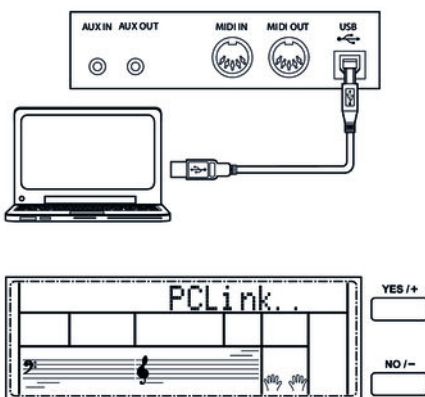

Start your computer and then connect the USB port on the rear panel of the digital piano to the USB port on your computer using a standard USB cable (not included). Then turn the digital piano on.

After the two devices have been connected without errors, the piano display shows ‘PCLink’.

Now you can copy up to three MIDI files as user songs to the digital piano, as well as back up all your styles and recordings to the storage of the PC.

Any other application may require additional software as for recording or editing sound files (not included).

9 Troubleshooting

Problem	Possible causes and solutions
You hear a 'pop' sound from the speakers when switching the digital piano on and off.	This is normal. No need to worry.
No sound can be heard when playing the piano.	<p>Make sure that the volume control is set appropriately.</p> <p>Check if headphones are plugged into the headphone output 2. Connecting headphones will mute the speakers of the digital piano.</p>
Malfunction occurs when using a mobile phone.	Using a mobile phone near the digital piano can cause interference. To prevent this, turn off the mobile phone or use it only at a safe distance.

10 Voice list

No.	Name	LCD	No.	Name	LCD
Piano			030	Velocity Crossfade Electric Piano	VeCrosEP
001	Stereo Grand Piano	StGrdPno	031	Layered Electric Piano 1	LayerEp1
002	Acoustic Grand Piano (wide) 1	GrandPnW	032	Layered Electric Piano 2	LayerEp2
003	Acoustic Grand Piano (dark)	GrandPnD	033	Nylon Electric Piano	NylonEP
004	Octave Piano 1	OctPno1	034	Warm Electric Piano	WarmEp
005	Octave Piano 2	OctPno2	035	Grand Harpsichord	GraHarps
006	Piano & Strings	Pno&Str	036	Harpsichord 1	Harpsi
007	Piano & Choir	Pno&Cho	037	Harpsichord 2	Harpsi2
008	Acoustic Grand Piano	GrandPno	038	Harpsichord (wide)	HarpsiW
009	Stereo Bright Piano	StBrtPno	039	Harpsichord (octave mix) 1	HarpsiO
010	Bright Acoustic Piano	BritePno	040	Harpsichord Release	HarpsiR
011	Bright Acoustic Piano (wide) 1	BritePnW	041	Harpsichord (with key off)	HarpsiOf
012	Chorus Piano	ChoruPno	042	Clavi 1	Clavi
013	Electric Grand Piano	E.Grand	043	Clavi 2	Clavi2
014	Electric Grand Piano (wide)	E.GrandW	044	Clavi (wide) 1	ClaviW1
015	Stereo Honk-Tonk	StHonkTo	045	Clavi (wide) 2	ClaviW2
016	Honky-tonk Piano	HnkyTonk	046	Clavi Wah	ClaviWa
017	Honky-tonk Piano (wide) 1	HnyTonkW	047	Pulse Clavi	PluseClv
018	Stereo Hard Electric Piano	StHarEp	Chromatic Percussion		
019	Detuned Electric Piano 1	DetunEP1	048	Celesta 1	Celesta
020	Detuned Electric Piano 2	DetunEP2	049	Celesta 2	Celesta2
021	Electric Piano 1	E.Piano1	050	Birght Celeasta	BirCelea
022	Electric Piano 2	E.Piano2	051	Celesta & Sine	Celes&Si
023	Electric Piano (wide) 1	EPnoW1	052	Reecho Bell	RechBell
024	Electric Piano (wide) 2	EPnoW2	053	Celesta & Music Box	Celes&MB
025	EP legend	EPLegend	054	Glockenspiel 1	Glocken
026	EP Phase	EPPHase	055	Glockenspiel 2	Glocken2
027	60's Electric Piano	60'sEP	056	Music Box 1	MusicBox
028	Electric Piano 1 (velocity mix)	E.PnoV1	057	Music Box 2	MusicBo2
029	Electric Piano 2 (velocity mix)	E.PnoV2	058	Music Box 3	MusicBo3

No.	Name	LCD	No.	Name	LCD
059	Toy Box	ToyBox	088	Percussive Organ 1	PercOrgn
060	Music Box & Harp	Mbx&Harp	089	Percussive Organ 2	PercOrg2
061	Stereo Vibrapho	StVibes	090	Light Click Organ	LClickOr
062	Rigid Vibraphone	RigiVibe	091	Detuned Percussive Organ	DePerOrg
063	Vibraphone 1	Vibra	092	Stereo Rotary Organ	StRotaOr
064	Vibraphone 2	Vibra2	093	Rock Organ	RockOrgn
065	Vibraphone (wide) 1	VibraW	094	Rotary Organ	RotaOrgn
066	Vibraphone (wide) 2	VibraW2	095	Slow Rotary Organ	SloRotOr
067	Vibraphone & Bell	Bell&Vib	096	Detuned Church Organ	DeChuOrg
068	Marimba 1	Marimba	097	Church Organ 1	ChurOrgn
069	Marimba 2	Marimba2	098	Church Organ 2	ChurOrg2
070	Marimba (wide)	MarimbaW	099	Church Organ (octave mix)	ChurOrgO
071	Stereo Marimba	StMarim	100	Reed Organ	ReedOrgn
072	Marimba & Vibraphone	Mar&Vib	101	Puff Organ	PuffOrgn
073	Xylophone 1	Xylophon	102	Accordion 1	Acordion
074	Xylophone 2	Xylopho2	103	Accordion 2	Acordin2
075	Tubular Bells	TubulBel	104	Accordion 3	Acordin3
076	Church Bell	ChurBell	105	Mustte	Mustte
077	Carillon	Carillon	106	Accord It Solo	AccordSo
078	Dulcimer	Dulcimer	107	Sweet Harmonica	SwetHarm
079	Santur	Santur	108	Harmonica 1	Harmnica
Organ			109	Harmonica 2	Harmnic2
080	Drawbar Organ 1	DrawOrgn	110	Tango Accordion	TangoAcd
081	Drawbar Organ 2	DrawOrg2	111	Acoustic Guitar (nylon) 1	NylonGtr
082	Soft Stereo Drawbar Organ	SfDrawOr	112	Acoustic Guitar (nylon) 2	NylonGt2
083	Mellow Drawbar Organ	MellDrOr	113	Acoustic Guitar (nylon + key off)	NylGtrOf
084	Detuned Drawbar Organ 1	DeDraOrg	114	Ukulele	Ukulele
085	Detuned Drawbar Organ 2	DeDraOr2	115	Velocity Nylon Guitar	NylnGtVe
086	Italian 60's Organ	60'sOrgn	116	Chorus Nylon Guitar	ChoNyGt
087	1970 Percussive Organ	1970PcOr	117	Bright Nylon Guitar	BrNyGt

Voice list

No.	Name	LCD	No.	Name	LCD
118	Acoustic Guitar (steel) 1	SteelGtr	148	Stereo Muted Guitar	StMuGt
119	Acoustic Guitar (steel) 2	SteelGt2	149	Guitar Pinch	GtPinch
120	Steel Guitar with Body Sound	SteelBdy	150	Overdriven Guitar	Ovrdrive
121	Tremolo Steel Guitar	TremGt	151	Distortion Guitar 1	DistGtr
122	Mandolin	Mandolin	152	Distortion Guitar 2	DistGt2
123	12-Strings Guitar	12StrGtr	153	Distortion Guitar (with feedback) 1	FeedbkGt
124	Chorus Steel Guitar	ChoSteGt	154	Distorted Rhythm Guitar	DistRyth
125	Nylon & Steel Guitar	Ny&SteGt	155	5th Distortion	5thDist
126	Stereo Steel Guitar	StSteGt	156	Stereo Distorted Guitar	StDistor
127	Steel Guitar Bend	GtBend	157	Guitar Feedback	GtrFedbk
128	Steel Guitar Harmonics	GtHarm	158	Guitar Harmonics	GtrHarmo
129	Velocity Steel Guita 1	VelSte1	Bass		
130	Velocity Steel Guita 2	VelSte2	159	Acoustic Bass 1	AcoBass
131	Velocity Steel Guita 3	VelSte3	160	Acoustic Bass 2	AcoBass2
132	Electric Guitar (jazz) 1	JazzGtr	161	Jazz Style	JazzSty
133	Electric Guitar (jazz) 2	JazzGt2	162	A.Bass & Mute G.T.	Bs&GtMu
134	Electric Guitar (pedal steel)	PedalGtr	163	Resonant Bass	ResBass
135	Mellow Guitar	MelloGt	164	Wah Bass 1	WahBass1
136	Velocity Jazz Guitar	JazzGtVe	165	Electric Bass (finger) 1	FngrBass
137	Jazz Guitar Detuned	JazzGtDt	166	Electric Bass (finger) 2	FngrBas2
138	Mid Tone Guitar	MidTonGt	167	Electric Bass (finger) 3	FngrBas3
139	Electric Guitar (clean) 1	CleanGtr	168	Finger Slap Bass	FngrSlap
140	Electric Guitar (clean) 2	CleanGt2	169	Wah Finger Bass	WahFnBs
141	Stereo Clean Guitar	StCleGtr	170	Electric Bass (pick) 1	PickBass
142	Velocity Clean Guitar	CleGtVel	171	Electric Bass (pick) 2	PickBas2
143	Electric Guitar (detuned clean)	DetClnGt	172	Mute Pick Bass	MuPkBass
144	Electric Guitar (muted velo-sw)	MutVelGt	173	Fretless Bass 1	Fretless
145	Electric Guitar (muted)	MutedGtr	174	Fretless Bass 2	Fretlss2
146	Electric Guitar (funky cutting)	FunkGt	175	Slap Bass 1	SlapBas1
147	Jazz Man	JazzMan	176	Slap Bass 2	SlapBas2

No.	Name	LCD	No.	Name	LCD
177	Slap Bass 3	SlapBas3	206	Pizzicato Strings 1	PizzStr
178	Slap Bass 4	SlapBas4	207	Pizzicato Strings 2	PizzStr2
179	Synth Bass 1	SynBass1	208	Octave Pizzicato	OctoPizz
180	Synth Bass 2	SynBass2	209	Orchestral Harp 1	Harp
181	Synth Bass 3 (resonance)	ResoBass	210	Orchestral Harp 2	Harp2
182	Synth Bass 4 (attack)	AtackBas	211	Yang Chin	YangChin
183	Synth Bass (warm)	WarmBass	212	Timpani 1	Timpani
184	Clavi Bass	ClavBass	213	Timpani 2	Timpani2
185	Hammer	Hammer	Ensemble		
186	Synth Bass (rubber)	RubbBass	214	The Strings	TheStr
187	Attack Pulse	AtackPls	215	String Ensembles 1	Strings1
Strings & Orchestral Instruments			216	String Ensembles 2	Strings2
188	The Violin	TheVin	217	Synth Strings 1	SynStrs1
189	Violin 1	Violin	218	Synth Strings 2	SynStrs2
190	Violin 2	Violin2	219	Synth Strings 3 Synth Strings	SynStrs3
191	Violin (slow attack)	SlViolin	220	Synth Strings 4	SynStrs4
192	Soft Violin	SoftVin	221	Synth Strings 5	SynStrs5
193	Viola 1	Viola	222	Resonant Strings	ResonSt
194	Viola 2	Viola2	223	Stereo Slow Strings	SSlowStr
195	Viola 3	Viola3	224	Slow Strings	SlowStr
196	Cello 1	Cello	225	Strings and Brass	Str&Bras
197	Cello 2	Cello2	226	Legato Strings	LegatStr
198	Celloen 16'	Celloen	227	Orchestra	Orchstr
199	Chamber Music	Chamber	228	Arco Strings	ArcoStr
200	Contrabass 1	Contrabs	229	60's Strings	60'sStr
201	Contrabass 2	Contrbs2	230	1970 Strings	70'Str
202	Tremolo Strings 1	TremStr	231	Solo Strings	SoloStr
203	Tremolo Strings 2	TremStr2	232	Choir Aahs 1	ChoirAah
204	Slow Tremolo Strings 1	SlwTrSt1	233	Choir Aahs 2	ChoirAh2
205	Slow Tremolo Strings 2	SlwTrSt2	234	Choir Aahs 3	ChoirAh3

Voice list

No.	Name	LCD	No.	Name	LCD
235	Stereo Choir Aahs	StChoir	264	Stereo French Horn	StFrHorn
236	Strings & Choir	StrChoir	265	Horn Orchestra	5thHornO
237	Humming	Humming	266	Brass Section 1	Brass
238	Voice Oohs	VoiceOoh	267	Brass Section 2 (octave mix)	Brass2
239	Analog Voice	AnaVoice	268	Brass Section 3	Brass3
240	Synth Voice	SynVoice	269	Brass Section 4	Brass4
241	Bass Hit Plus	BassHit	270	Brass Section 5	Brass5
242	Orchestra Hit 1	OrchHit	271	Brass Swell	BrasSwel
243	Orchestra Hit 2	OrchHi2	272	Brass Band	BrasBand
244	Euro Hit	EuroHit	273	Bright Brass Section	BrBraSec
245	6th Hit	6thHit	274	Mute Brass Ensemble	MuteEns
Brass			275	Sforzato Brass	SfrzBras
246	Trumpet 1	Trumpet	276	Brass & Strings	Bras&Str
247	Trumpet 2	Trumpet2	277	Synth Brass 1	SynBras1
248	Trumpet 3	Trumpet3	278	Synth Brass 2	SynBras2
249	Dark Trumpet Soft	DarkTrp	279	Synth Brass 3	SynBras3
250	Sweet Trumpet	SweetTp	280	Synth Brass 4	SynBras4
251	Wah Trumpet	WahTp	281	Analog Synth Brass 1	AnaBras1
252	Trombone 1	Trombone	282	Analog Synth Brass 2	AnaBras2
253	Trombone 2	Trmbone2	283	Jump Brass	JumpBras
254	Bright Trombone	BritBone	284	Octave Synth Brass	SynBraOc
255	Strings & Trombone	Str&Trb	285	Synth Brass & Strings 1	SyBr&St1
256	Tuba 1	Tuba	286	Synth Brass & Strings 2	SyBr&St2
257	Tuba 2	Tuba2	287	Echo Brass	EchoBr
258	Soft Tuba	SoftTuba	Reed		
259	Muted Trumpet 1	MuteTrp1	288	Soprano Sax 1	SprnoSax
260	Muted Trumpet 2	MuteTrp2	289	Soprano Sax 2	SprnSax2
261	French Horn 1	FrHorn	290	Soprano Sax Soft	SopSaxSf
262	French Horn 2 (warm)	FrHorn2	291	Slow Soprano Sax	SlSopSax
263	French Horn 3	FrHorn3	292	Sweet Soprano Sax	SweSpSax

No.	Name	LCD	No.	Name	LCD
293	Alto Sax	AltoSax	321	Square	Square
294	Soft Alto Sax	SoftAlto	322	Lead 1b (sine)	SineLead
295	Super Alto Sax	SuprAlto	323	Square Lead 1	SquarLd1
296	Tenor Sax 1	TenorSax	324	Lead 1a (square 2)	SquarLd2
297	Tenor Sax 2	TenoSax2	325	Lead 2a (sawtooth 2)	SawLead2
298	Baritone Sax	BariSax	326	Lead 2d (sequenced analog)	SquAnaLd
299	Sweet Oboe	SwetOboe	327	Lead 2 (sawtooth)	SawLead1
300	Oboe 1	Oboe	328	Lead 2b (saw + pulse)	SawPlsLd
301	Oboe 2	Oboe2	329	Lead 2c (double sawtooth)	DubSawLd
302	English Horn 1	EngHorn	330	Lead 3 (calliope)	CaliopLd
303	English Horn 2	EngHorn2	331	Lead 4 (chiff)	ChiffLd
304	Woodwinds	Woodwind	332	Lead 5 (charang)	CharanLd
305	Bassoon 1	Bassoon	333	Lead 5a (wire lead)	WireLead
306	Bassoon 2	Basson2	334	Lead 6 (voice)	VoiceLd
307	Clarinet 1	Clarinet	335	Lead 7 (fifths)	FifthsLd
308	Clarinet 2	Clarine2	336	Lead 8 (bass + lead)	BassLead
Pipe			337	Lead 8a (soft wrl)	SftWrlLd
309	Piccolo	Piccolo	Synth Pad		
310	Flute	Flute	338	Pad 1 (new age)	NewAgePd
311	Sweet Flute	SwEEFlut	339	Slow Square	SlowSqu
312	Recorder	Recorder	340	New Year Pad	NewYrPd
313	Sweet Pan Flute	SwPanFu	341	Pad 2 (warm)	WarmPad
314	Pan Flute	PanFlute	342	PWM Pad	PWMPad
315	Blown Bottle	Bottle	343	Pad 2a (sine pad)	SinePad
316	Shakuhachi	Shakhchi	344	Horn Pad	HornPad
317	Whistle 1	Whistle	345	Pad 3 (polysynth) 1	PolySyPd
318	Whistle 2	Whistle2	346	Click Pad	ClickPd
319	Ocarina	Ocarina	347	Analog Pad	AnaloPad
Synth Lead			348	Poly Pad	PolyPad
320	Lead 1 (square)	SquareLd	349	Pad 4 (choir)	ChoirPad

Voice list

No.	Name	LCD	No.	Name	LCD
350	Pad 4a (itopia)	ItopiaPd	378	Shamisen	Shamisen
351	Pad 5 (bowed) 1	BowedPad	379	Koto	Koto
352	Pad 6 (metallic) 1	MetalPad	380	Taisho Koto	TaishoKt
353	Pan Pad	PanPad	381	Kalimba	Kalimba
354	Pad 7 (halo) 1	HaloPad	382	Bag Pipe	Bagpipe
355	Pad 7 (halo) 2	HaloPad2	383	Fiddle	Fiddle
356	Pad 8 (sweep) 1	SweepPad	384	Shanai	Shanai
357	Pad 8 (sweep) 2	SweePad2	Percussive		
358	Dipolar Pad	DipolPad	385	Tinkle Bell	TnklBell
359	Rising	Rising	386	Agogo	Agogo
360	Congregate	Congrega	387	Steel Drums	SteelDrm
Synth SFX			388	Woodblock	WoodBlok
361	FX 1 (rain)	FXRain	389	Castanets	Castanet
362	FX 2 (soundtrack)	Soundtrk	390	Taiko Drum	TaikoDum
363	Progenitor	Progenit	391	Concert Bass Drum	ConBasDm
364	FX 3a (synth mallet)	SynMalet	392	Melodic Tom 1	MelodTom
365	FX 3 (crystal)	Crystal	393	Melodic Tom 2 (power)	MeldTom2
366	FX 4 (atmosphere)	Atmosphr	394	Synth Drum	SynDrum
367	Warm Air	WarmAir	395	Rhythm Box Tom	RhythBox
368	FX 5 (brightness)	Bright	396	Electric Drum	ElecDrum
369	FX 6 (goblins)	Goblins	397	Reverse Cymbal	RevCymb1
370	Choir Bell	ChoirBel	SFX		
371	FX 7 (echoes) 1	Echoes	398	Guitar Fret Noise	FretNoiz
372	FX 7a (echo bell) 1	EchoBell	399	Guitar Cutting Noise	GtCtNoiz
373	FX 7b (echo pan)	EchoPan	400	Acoustic Bass String Slap	BsStSlap
374	FX 8 (sci-fi)	Sci-Fi	401	Breath Noise	BrthNoiz
Ethnic Misc.			402	Flute Key Click	FlKeyClk
375	Sitar 1	Sitar	403	Seashore	Seashore
376	Sitar 2 (bend)	Sitar2	404	Rain	Rain
377	Banjo	Banjo	405	Thunder	Thunder

No.	Name	LCD	No.	Name	LCD
406	Wind	Wind	436	Gunshot	Gunshot
407	Stream	Stream	437	Machine Gun	MachnGun
408	Bubble	Bubble	438	Lasergun	Lasergun
409	Bird Tweet 1	Tweet	439	Explosion	Explosio
410	Dog	Dog	440	Stereo Piano & Strings Pad	StPn&Str
411	Horse Gallop	HouseGlp	441	Stereo Piano & Choir	StPn&Cho
412	Bird Tweet 2	Tweet2	442	Stereo Piano & Synth Strings	StPn&Syn
413	Sheep	Sheep	443	Stereo Piano & Warm Pad	StPn&Pad
414	Telephone Ring 1	Telephone	444	Stereo Piano & Soft Ep	StPn&Ep
415	Telephone Ring 2	Telphon2	445	FM Electric Piano	FMEp
416	Door Creaking	DoorCrek	446	Digital Piano	DigiPn
417	Door	Door	447	E.Piano & Strings	EP&Str
418	Scratch	Scratch	448	E.Piano & Ac Guitar	EP&Gt
419	Wind Chime	WindChim	449	E.Piano & Vibraphone	Ep&Vib
420	Helicopter	Helicptr	450	E.Piano 2 & Pad	Ep&Pad
421	Car Engine	CarEngin	451	E.Piano 2 & Strings	Ep2&Str
422	Car Stop	CarStop	452	Harpichord & Stereo Strings	Harps&Str
423	Car Pass	CarPass	453	Music Box & Stereo Strings	Mxb&Str
424	Car Crash	CarCrash	454	Vibraphone & Stereo Strings	Vib&Str
425	Siren	Siren	455	Vibraphone Octave	VibOct
426	Train	Train	456	Vibraphone & Marimba & Kalimba	VibMK
427	Jetplane	Jetplane	457	Marimba & Kalimba	Mar&Kal
428	Starship	Starship	458	Marimba Delay	MarDel
429	Burst Noise	BurtNois	459	Xylophone Octave	XylopOct
430	Applause	Applause	460	Organ & Stereo Strings	Org&Str
431	Laughing	Laughing	461	Stereo Organ & Piano	StOr&Pno
432	Screaming	Scream	462	Rock Organ & Strings	RoOr&Str
433	Punch	Punch	463	Church Organ & Choir	ChuOr&Ch
434	Heart Beat	HeartBet	464	Church Organ & Strings	ChuOr&St
435	Footsteps	Footstep	465	Acoustic Guitar & Flute	Gt&Fl

Voice list

No.	Name	LCD	No.	Name	LCD
466	Acoustic Guitar & Clav	Gt&Cl	Arabic Instruments		
467	24 String Guitar	24Gt	486	Kanoun	Kanoun
468	Steel Guitar & Warm Pad	StGt&Pad	487	Aoud	Aoud
469	Stereo Strings & Horn	StStr&Hn	488	Bouzouk	Bouzouk
470	Orchestra	Orchest	489	Nay	Nay
471	Full Strings 1	FullStr1	490	Mizmar	Mizmar
472	Full Strings 2	FullStr2	Drum Set		
473	Symphonic	Symphon	491	Standard Set	StandSet
474	Stereo Choir & Strings	StCh&Str	492	Room Set	RoomSet
475	Stereo Choir & Steel Guitar	Ch&Gt	493	Power Set	PowerSet
476	3 Trumpet Loose	3Trump	494	Electronic Set	ElectSet
477	Trombone & Stereo Strings	Tb&StStr	495	Analog Set	AnalgSet
478	3 Trombones Loose	3Tromb	496	Jazz Set	JazzSet
479	3 Muted Trumpets Loose	3MuTrumb	497	Brush Set	BrushSet
480	Club Brass	ClubBras	498	Orchestra Set	OrcheSet
481	Brass & Woodwinds	Br&Wood	499	SFX Set	SFXSet
482	Woodwinds & Strings	Wind&Str	500	Arabic Set	ArabiSet
483	Section Woods Small	WoodSma			
484	Pan Flute & Strings Pad	PanFu&St			
485	Koto & Shamisen	Koto&Sh			

11 Styles list

No.	Name	LCD	No.	Name	LCD
8 BEAT			029	16Beat Modern	16BModr
001	8Beat Piano	8BtPiano	030	16Beat 3	16Beat3
002	8Beat 1	8Beat1	031	Cool Beat	CoolBeat
003	8Beat Shuffle	8BtShufl	032	16Beat Ballad 2	16BtBld2
004	Guitar Pop 1	GtPop1	033	16Beat 4	16Beat4
005	8Beat Hip Hop	8BtHiHop	034	Pop Shuffle	PopShufl
006	8Beat R&B	8BeatR&B	POP		
007	8Beat Pop	8BtPop	035	Pop Rock 1	PopRock1
008	Pop Funk 1	PopFunk1	036	Pop Dance 1	PopDanc1
009	Rhythm & Beat 1	Rhy&Bt1	037	Pop Fusion	PopFusn
010	8Beat Disco 1	8BtDisc1	038	Analog Night 1	AnalgNt1
011	8Beat Rock	8BtRock	039	6/8 Pop	6/8Pop
012	8Beat 2	8Beat2	040	Brit. Pop 1	BritPop1
013	Sweet Beat	SweetBt	041	Brit. Pop 2	BritPop2
014	8Beat Dance	8BtDance	042	Pop Hit	PopHit
015	8Beat Disco 2	8BtDisc2	043	Fusion Shuffle	FusShufl
016	8Beat 3	8Beat3	044	Analog Night 2	AnalgNt2
017	60's 8Beat	60's8Bt	045	Pop Beat	PopBeat
16 BEAT			046	Soft Beat	SoftBeat
018	16Beat 1	16Beat1	047	60's Pop	60'sPop
019	16Beat Funk 1	16BtFuk1	048	Sting Latin	StigLatn
020	16Beat Ballad 1	16BtBld1	BALLAD		
021	16Beat R&B	16BtR&B	049	R&B Ballad 1	R&Bbad1
022	Pop 16Beat 1	Pop16Bt1	050	Guitar Ballad	GtBallad
023	16Beat Funk 2	16BtFuk2	051	Ballad Rcok	BalladRk
024	16Beat Dance	16BDanc	052	Piano Pop	PianoPop
025	16Beat 2	16Beat2	053	Soft Ballad	SoftBald
026	Pop 16Beat 3	Pop16Bt3	054	Natural Ballad	NatuBld
027	Modern 16Beat	Modrn16B	055	Love Ballad	LoveBld
028	16Beat Hot	16BtHot	056	Easy Ballad	EasyBld

Styles list

No.	Name	LCD	No.	Name	LCD
057	Slow Ballad	SlowBald	085	Cha Cha 2	ChaCha2
058	Folk Ballad	FolkBld	086	Beguine 1	Beguine1
059	Pop Ballad 1	PopBld1	087	Beguine 2	Beguine2
060	Pop Ballad 2	PopBld2	088	Rumba 1	Rumba1
061	EP Ballad	EPBallad	089	Samba 1	Samba1
ROCK			090	Samba 2	Samba2
062	Rock	Rock	091	Jive	Jive
063	New Wave	NewWave	092	Fox Trot	FoxTrot
064	Ska	Ska	DANCE		
065	Pop Rock 2	PopRock2	093	Techno 1	Techno1
066	Slow Rock	SlowRock	094	Hip Hop 1	HipHop1
067	70's Rock & Roll	70'sRock	095	Dream Dance	DrumDance
068	Folk Rock	FolkRock	096	House	House
069	Soft Rock	SoftRock	097	Pop Dance 2	PopDanc2
070	Easy Rock	EasyRock	098	Down Beat	DownBeat
071	New Shuffle	NewShufl	099	Progressive	Progress
072	Rock Hip Hop	RkHipHop	100	Rap 1	Rap1
073	Rock&Roll 1	R'N'R1	101	Disco	Disco
074	Rock & Roll 2	R'N'R2	102	Soft Disco	SoftDisc
BALLROOM			103	Disco Party	DscParty
075	Tango 1	Tango1	104	70's Disco	70'sDisc
076	Spain Matador	Matador	105	Club Dance	ClubDanc
077	Twist 1	Twist1	106	Euro Dance	EuroDanc
078	Big Band Fox	BandFox	107	Hip Hop 2	HipHop2
079	Tango 2	Tango2	SOUL & FUNK		
080	Slow Fox	SlowFox	108	Funk 1	Funk1
081	Slow Waltz 1	SlowWlz1	109	Classic Funk	ClasFunk
082	Swing Fox	SwingFox	110	Gospel Swing	GopSwing
083	Salsa 1	Salsa1	111	Gospel	Gospel
084	Cha Cha 1	ChaCha1	112	Funk 2	Funk2

No.	Name	LCD	No.	Name	LCD
113	Electric Funk	ElecFunk	141	Bluegrass 1	Bluegrs1
114	Groove Funk	GrooveFk	142	Country 8Beat	Ct8Beat
115	Cool Funky	ColFunky	143	Modern Country	ModernCt
116	Jazz Funk	JazzFunk	144	Country Pop 2	CntyPop2
117	Groove	Groove	145	Bluegrass 2	Bluegrs2
118	Soul	Soul	146	2/4 Country	2/4Cntry
119	Hip Hop Beat	HipHopBt	147	Country Quick Steps	QuickStp
120	R&B	R&B	148	Country Folk	CntyFolk
121	Soul Beat	SoulBeat	149	Country Shuffle	CnyShufl
122	R&B Ballad 2	R&BBld2	LATIN & LATIN DANCE		
SWING & JAZZ			150	Bossa Nova	BosaNov
123	Latin Jazz 1	LatinJz1	151	Latin	Latin
124	Big Band	BigBand	152	New Reggae	NewReggae
125	Dixieland 1	Dixland1	153	Dance Reggae	DanReggae
126	Broadway Big Band	BwayBand	154	Pasodoble	Pasodobl
127	Swing	Swing	155	Lite Bossa	LteBossa
128	Latin Jazz 2	LatinJz2	156	Latin Rock	LatinRck
129	Fusion	Fusion	157	Disco Samba	DscSamba
130	Acid Jazz	AcidJazz	158	Mambo	Mambo
131	Cool Jazz Ballad	CoolJzBd	159	Rumba 2	Rumba2
132	Swing Shuffle	SwingSfl	160	Tikitikita	Tikitkta
133	Big Band Medium	BandMid	161	Lambada	Lambada
134	Dixieland 2	Dixland2	162	Pop Cha Cha 1	PChaCha1
135	Guitar Swing 2	GtSwing2	163	Pop Cha Cha 2	PChaCha2
136	Ragtime	Ragtime	164	Salsa 2	Salsa2
137	Modern Jazz Ballad	MdJzBald	WALTZ & TRADITIONAL		
138	Swing Ballad	SwingBal	165	Waltz	Waltz
139	Orchestra Swing	OrhSwing	166	Old Waltz	OldWaltz
COUNTRY			167	English Waltz	EngWaltz
140	Country Pop 1	CntyPop1	168	German Waltz	GemWaltz

Styles list

No.	Name	LCD	No.	Name	LCD
169	ViennaWaltz	VinaWtz	185	Dangdut	Dangdut
170	Slow Waltz 2	SlwWltz2	186	6/8 Flipper	6/8Flipp
171	Jazz Waltz	JzWaltz	187	New Age	NewAge
172	Polka	Polka	188	Tarantella	Tarantel
173	6/8 March	6/8March	189	Scottish	Scottish
174	German Polka	GerPolka	190	Norteno	Norteno
175	Party Polka	PtyPolka	Arab		
176	Army March	ArmMarch	191	Zarb 6/8	Zarb 6/8
177	March	March	192	Zarb Tempo	ZarbTemp
178	US March	USMarch	193	Bandary	Bandary
179	Musette	Musette	194	Zarb Daf	Zarb Daf
180	Mazurke	Mazurke	195	Pop 4/4	Pop 4/4
World			196	Saidi IR	Saidi IR
181	Enka Ballad	EnkaBald	197	Cifte	Cifte
182	Laendler	Laendler	198	Baladi	Baladi
183	Hawaiian	Hawaiian	199	Masmoudi	Masmoudi
184	Sirtake	Sirtake	200	Wehda	Wehda

12 Practise and demo songs

No.	Name	LCD	No.	Name	LCD
FOLK & COUNTRY			028	Mov.2 Adagio Non Troppo Piano Sonata No.9 In D	Sonata9
001	Jambalaya	Jambalay	029	Mov.1 Andante Grazioso Piano Sonata No.11 In A (Alla TurSo- nata11ca)	Sonata11
002	Ding! Dong! Merrily On High	DingDong	030	Prelude In C	Prelude
003	Battle Hymn Of The Republic	Battle	031	Chinese Dance	ChDance
004	The Old Gray Mare	GrayMare	032	Emperors Waltz	EmprWalz
005	American Patrol	USPatrol	033		MilMar1
006	Christmas Is Coming	IsComing	034	Symphony No.40	Symphony
007	Sippin`Cider Through A Straw	SCTStraw	JAZZ & FUSION		
008	Christmas Sound	Sound	035	ShanZhaShu	ShanZhaS
GOLDEN & POP			036	You Are My Sunshine	MySun
009	On London Bridge	LdBridge	037	June Samba	JunSamba
010	Are You Lonesome Tonight	Lonesome	038	Funk	Funk
011	Der Deitcher`s Dog	DerDDog	039	I Can.....	I Can...
012	Joy to The World	JoyWorld	040	Sea Shore	SeaShore
013	Silent Night	SltNight	PIANO		
014	Ave Maria	AveMaria	041	Fur Elise	FurElise
015	Five Hundred Miles	FHMiles	042	Military March	MMarch
016	Happy New Year	HappyNY	043	Habanera	Habanera
017	It`s Beginning To Look A Lot Like Christmas	LikeXmas	044	Minuet	Minuet
018	Jeanie With The Light Brown Hair	LighHair	045	Austria Variation	AVariati
019	My Bonnie	MyBonnie	046	Old Macdonald Had A Farm	OldAFarm
020	Song Of The Pearlfisher	SongOfTP	047	Wedding March	Wedding
CLASSICAL			048	2-Part Invention #13 In A Minor.B.W. lii	Invntion
021	Swan	Swan	049	Minuet In G	MinuetG
022	Prelude To Act 2 (Swan Lake)	SwanLak1	050	Turkish March	TurkishM
023	Valse (Swan lake)	SwanLak2	051	Hey Diddle Diddle	HeDiddle
024	The Happy Farmer	HpFarmer	052	Italian Polka	ItaPolka

Practise and demo songs

No.	Name	LCD	No.	Name	LCD
025	The Sleeping Beauty	SleepBty	053	Moseta Dance	MosetaDn
026	La Traviata	LaTravia	054	Bulie Dance	BulieDn
027	Wiegenlied	Wiegenli	055	Waltz in A Flat Op.39 No.15	Waltz in A

No.	Name	LCD	No.	Name	LCD
056	Wild Rose	WildRose	059	Angles We Have Heard On High	Angles
057	Away In A Manger	AwayInAM	060	Waltz	Waltz
058	Jack & Jill	JackJill			

Demos

No.	Name	LCD
001	Fantasia Impromptu	Fantasia
002	Funk	Funk

13 Chord list

	Chord description	Normal chord construction	Chord symbol	Display
0	Major [M]	1-3-5	C	C
1	Major sixth [6]	1-(3)-5-6	C6	C6
2	Major seventh [M7]	1-3-(5)-7	CM7	CM7
3	Major seventh with augmented eleventh [M7#11]	1-(2)-3-#4-(5)-7	CM7#11	CM7(#11)
4	Major add ninth [Madd9]	1-2-3-5	CMadd9	CM(9)
5	Major ninth [M9]	1-2-3-(5)-7	CM9	CM7(9)
6	Major sixth and ninth [6 9]	1-2-3-(5)-6	C6 9	C6(9)
7	Augmented [aug]	1-3-#5	Caug	Caug
8	Minor [m]	1-b3-5	Cm	Cm
9	Minor sixth [m6]	1-b3-5-6	Cm6	Cm6
10	Minor seventh [m7]	1-b3-(5)-b7	Cm7	Cm7
11	Minor seventh flatted fifth [m7b5]	1-b3-b5-b7	Cm7b5	Cm7(b5)
12	Minor add ninth [madd9]	1-2-b3-5	Cmadd9	Cm(9)
13	Minor ninth [m9]	1-2-b3-(5)-b7	Cm9	Cm7(9)
14	Minor eleventh [m11]	1-(2)-b3-4-5-(b7)	Cm11	Cm7(11)
15	Minor major ninth [mM7]	1-b3-(5)-7	CmM7	CmM7
16	Minor major ninth [mM9]	1-2-b3-(5)-7	CmM9	CmM7(9)
17	Diminished [dim]	1-b3-b5	Cdim	Cdim
18	Diminished seventh [dim7]	1-b3-b5-6	Cdim7	Cdim7
19	Seventh [7]	1-3-(5)-b7	C7	C7
20	Seventh suspended [7sus4]	1-4-5-b7	C7sus4	C7sus4
21	Seventh flatted fifth [7b5]	1-3-b5-b7	C7b5	C7(b5)
22	Seventh ninth [79]	1-2-3-(5)-b7	C7 9	C7(9)
23	Seventh sharp eleventh [7#11]	1-2-3-#4-(5)-b7 oder 1-(2)-3-#4-5-b7	C7#11	C7(#11)
24	Seventh thirteenth [7 13]	1-3-(5)-6-b7 oder 2-3-5-6-b7	C7 13	C7(13)
25	Seventh flatted ninth [7b9]	1-b2-3-(5)-b7	C7b9	C7(b9)
26	Seventh flatted thirteenth [7b13]	1-3-5-b6-b7	C7b13	C7(b13)
27	Seventh sharp ninth [7#9]	(1)-#2-3-(5)-b7	C7#9	C7(#9)
28	Major seventh augmented [M7aug]	1-3-#5-7	CM7aug	CM7aug

Chord list

	Chord description	Normal chord construction	Chord symbol	Display
29	Seventh augmented [7aug]	(1)-3-#5-b7	C7aug	C7aug
30	Suspended fourth [sus4]	1-4-5	Csus4	Csus4
31	Suspended second [1+2+5]	1-2-5	C1+2+5	C

14 MIDI implementation chart

Function		Sent	Received	Notes
Basic Channel	Default	1	1 – 16	
	Changed	1 – 16	1 – 16	
Mode	Default	No	Mode 3	
	Messages	No	No	
	Altered	*****	No	
Note Number		0 – 127	0 – 127	
	True voice	*****	0 – 127	
Velocity Note	Note ON	Yes, 9nH, v = 1 – 127	Yes, 9nH, v = 1 – 127	
	Note OFF	No, 9nH, v = 0	Yes, 9nH, v = 0 or 8nH, v = 0 – 127	
After Touch	Keys	No	No	
	Channels	No	No	
Pitch Bend		No	Yes	
Control Change	0	Yes	Yes	Bank Select
	1	No	Yes	Modulation
	5	No	Yes	Portamento Time
	6	Yes	Yes	Data Entry
	7	Yes	Yes	Volume
	10	No	Yes	Pan
	11	No	Yes	Expression
	64	Yes	Yes	Sustain Pedal
	65	No	Yes	Portamento ON/OFF
	66	Yes	Yes	Sostenuto Pedal
	67	Yes	Yes	Soft Pedal
	80	No	Yes	Reverb Program
	81	No	Yes	Chorus Program
	91	Yes	Yes	Reverb Level
	93	Yes	Yes	Chorus Level
	120	Yes	Yes	All Sound Off
121	No	No	Reset All Controllers	
123	Yes	Yes	All Notes Off	

MIDI implementation chart

Function		Sent	Received	Notes
Program Change	True #	Yes *****	Yes 0 – 127	
System Exclusive		No	Yes	
System Common	Song Position Pointer	No	No	
	Song Select	No	No	
	Tune Request	No	No	
System Real Time	Clock	Yes	No	
	Commands	No *1	No	
Aux Messages	LOCAL ON/OFF	No	No	
	Active Sensing	No	Yes	
	System Reset	No	No	
Notes:	*1 When the accompaniment starts, an FAH message is transmitted. When the accompaniment stops, an FCH message is transmitted. When an FAH message is received, the accompaniment starts. When an FCH message is received, the accompaniment stops.			

MIDI channel modes

	POLY	MONO ON
OMNI ON	Mode 1	Mode 2
OMNI OFF	Mode 3	Mode 4

15 Technical specifications

Display	Multifunction LCD	
Keyboard	88 weighted keys with hammer action and adjustable touch response	
Polyphony	128-voice	
Voices	500	
Styles	200	
Practise songs	60	
Demo songs	2	
Album	120 Songs	
Memory	32 memory locations	
Pedals	Multifunction pedal, Sostenuto, Sustain	
Connections	Voltage supply AC 230 V ~, 2 × headphones (1/4" phone jack), AUX, USB, MIDI	
Amp	10 W	
Speaker	2 × 20 W, 8 Ω 2 × 25 W, 8 Ω	
Operating supply voltage	230 V ~ 50 Hz	
Dimensions (W × H × D)	1380 mm × 514 mm × 906 mm	
Weight	53 kg	
Housing colour	Black	Item number 352288
	White	Item number 352389

16 Protecting the environment

Disposal of the packaging material



For the transport and protective packaging, environmentally friendly materials have been chosen that can be supplied to normal recycling.

Ensure that plastic bags, packaging, etc. are properly disposed of.

Do not just dispose of these materials with your normal household waste, but make sure that they are collected for recycling. Please follow the notes and markings on the packaging.

Disposal of your old device



This product is subject to the European Waste Electrical and Electronic Equipment Directive (WEEE) in its currently valid version. Do not dispose with your normal household waste.

Dispose of this device through an approved waste disposal firm or through your local waste facility. When discarding the device, comply with the rules and regulations that apply in your country. If in doubt, consult your local waste disposal facility.

