



**the
box**

MBA120W
battery-powered
speaker

Musikhaus Thomann
Thomann GmbH
Hans-Thomann-Straße 1
96138 Burgebrach
Germany
Telephone: +49 (0) 9546 9223-0
E-mail: info@thomann.de
Internet: www.thomann.de

28.06.2019, ID: 359284 (V6)

Table of contents

1	General information	5
	1.1 Further information.....	6
	1.2 Notational conventions.....	7
	1.3 Symbols and signal words.....	8
2	Safety instructions	10
3	Features	16
4	Installation	17
	4.1 Battery operation.....	18
	4.2 Remote control.....	19
	4.3 Microphone.....	20
5	Connections and operating elements	21
6	Technical specifications	44
7	Plug and connection assignment	48
8	Cleaning	52

9 Protecting the environment..... 53

1 General information

This user manual contains important information on the safe operation of the device. Read and follow all safety notes and all instructions. Save this manual for future reference. Make sure that it is available to all persons using this device. If you sell the device to another user, be sure that they also receive this manual.

Our products and user manuals are subject to a process of continuous development. We therefore reserve the right to make changes without notice. Please refer to the latest version of the user manual which is ready for download under www.thomann.de.

1.1 Further information

On our website (www.thomann.de) you will find lots of further information and details on the following points:

Download	This manual is also available as PDF file for you to download.
Keyword search	Use the search function in the electronic version to find the topics of interest for you quickly.
Online guides	Our online guides provide detailed information on technical basics and terms.
Personal consultation	For personal consultation please contact our technical hotline.
Service	If you have any problems with the device the customer service will gladly assist you.

1.2 Notational conventions

This manual uses the following notational conventions:

Letterings

The letterings for connectors and controls are marked by square brackets and italics.

Examples: *[VOLUME]* control, *[Mono]* button.

Displays

Texts and values displayed on the device are marked by quotation marks and italics.

Examples: *'24ch'*, *'OFF'*.

Cross-references



References to other locations in this manual are identified by an arrow and the specified page number. In the electronic version of the manual, you can click the cross-reference to jump to the specified location.

Example: See  *'Cross-references'* on page 7.

1.3 Symbols and signal words

In this section you will find an overview of the meaning of symbols and signal words that are used in this manual.

Signal word	Meaning
DANGER!	This combination of symbol and signal word indicates an immediate dangerous situation that will result in death or serious injury if it is not avoided.
CAUTION!	This combination of symbol and signal word indicates a possible dangerous situation that can result in minor injury if it is not avoided.
NOTICE!	This combination of symbol and signal word indicates a possible dangerous situation that can result in material and environmental damage if it is not avoided.

Warning signs	Type of danger
	Warning – high-voltage.
	Warning – danger zone.

2 Safety instructions

Intended use

This device is designed for sound reinforcement. Use the device only as described in this user manual. Any other use or use under other operating conditions is considered to be improper and may result in personal injury or property damage. No liability will be assumed for damages resulting from improper use.

This device may be used only by persons with sufficient physical, sensorial, and intellectual abilities and having corresponding knowledge and experience. Other persons may use this device only if they are supervised or instructed by a person who is responsible for their safety.



DANGER!

Danger for children

Ensure that plastic bags, packaging, etc. are disposed of properly and are not within reach of babies and young children. Choking hazard!

Ensure that children do not detach any small parts (e.g. knobs or the like) from the unit. They could swallow the pieces and choke!

Never let children unattended use electrical devices.



DANGER!

Electric shock caused by high voltages inside

Within the device there are areas where high voltages may be present. Never remove any covers.

There are no user-serviceable parts inside.

Do not use the device if covers, protectors or optical components are missing or damaged.



DANGER!

Electric shock caused by short-circuit

Always use proper ready-made insulated mains cabling (power cord) with a protective contact plug. Do not modify the mains cable or the plug. Failure to do so could result in electric shock/death or fire. If in doubt, seek advice from a registered electrician.



CAUTION!

Possible hearing damage

The device can produce volume levels that may cause temporary or permanent hearing impairment. Over an extended period of time, even levels that seem to be uncritical can cause hearing damage.

Decrease the volume level immediately if you experience ringing in your ears or hearing impairment. If this is not possible, keep a greater distance or use sufficient ear protectors.



NOTICE!

Risk of fire

Do not block areas of ventilation. Do not install the device near any direct heat source. Keep the device away from naked flames.



NOTICE!

Power supply

Before connecting the device, ensure that the input voltage (AC outlet) matches the voltage rating of the device and that the AC outlet is protected by a residual current circuit breaker. Failure to do so could result in damage to the device and possibly injure the user.

Unplug the device before electrical storms occur and when it is unused for long periods of time to reduce the risk of electric shock or fire.



NOTICE!

Risk of fire due to incorrect polarity

Incorrectly inserted batteries may destroy the device or the batteries.

Ensure that proper polarity is observed when inserting batteries.



NOTICE!

Possible damage by leaking batteries

Leaking batteries can cause permanent damage to the device.

Take batteries out of the device if it is not going to be used for a longer period.



NOTICE!

Possible damage due to incorrect storage

Deep discharge can cause batteries to become permanently damaged or lose some of their capacity.

Before prolonged rest periods, charge the batteries to around 50 % of their capacity and then switch the equipment off. Store the equipment at a temperature between 10 °C and 32 °C in as dry an environment as possible. During extended storage periods, charge the batteries to 50 % approximately every three months.

Notes on radio transmission

- This equipment uses a frequency range that is free of charge and registration within the European Union.
For more information, please visit: <http://www.thomann.de>.
- When operating, make sure that transmitter and receiver are set to the same channel.
- Never set more than one transmitter to the same channel.
- Make sure that no metal objects are located between transmitter and receiver.
- Avoid interference by other radio and in-ear systems.

3 Features

The mobile PA system is characterized by the following features:

- Compact all-in-one system
- Power supply via AC mains power or through the built-in rechargeable batteries
- 10" woofer, 1" compression driver
- 120 W output power in mains operation, 80 W in battery operation
- Frequency range 55 Hz ... 18 kHz
- 2-band equalizer
- Integrated adjustable Delay (Echo) effect
- Integrated UHF receiver for the supplied UHF wireless microphone
- Slot for optional second UHF receiver
- Built-in media player with display, SD card slot, USB port and Bluetooth receiver
- Infrared remote control
- 2 × MIC / Line inputs, 1 × stereo input, 2 × RCA inputs
- 1 × line output
- Plastic housing with pole mount, carrying handle, trolley handle and casters
- Spacious storage compartment for accessories embedded in the housing
- Suitable cover (item no. 382254), not included)

4 Installation

Unpack and check carefully there is no transportation damage before using the unit. Keep the equipment packaging. To fully protect the product against vibration, dust and moisture during transportation or storage use the original packaging or your own packaging material suitable for transport or storage, respectively.

Create all connections while the device is off. Use the shortest possible high-quality cables for all connections. Take care when running the cables to prevent tripping hazards.



NOTICE!

Possible property damage by magnetic fields

Loudspeakers produce a static magnetic field. Therefore, maintain an appropriate distance to devices that can be adversely affected or damaged by an external magnetic field.

4.1 Battery operation

You can also operate the device independently of the mains power supply with the supplied integrated VRLA rechargeable batteries.

Installation and replacement of VRLA rechargeable batteries

Disconnect the device from the mains.

Remove the mounting screw of the battery compartment cover. Remove the two mounting screws of the fixing plate. Use only suitable VRLA rechargeable batteries of the same size and type (see [Chapter 6 'Technical specifications'](#) on page 44).

The power supply cables are colour-coded and equipped with blade receptacles. To release the connections, press slightly on the blade receptacle. When fitting and wiring VRLA rechargeable batteries, make sure the polarity is correct:

- red to + (battery 1)
- black to – (battery 2)
- blue connects + and – of the two rechargeable batteries

Then attach the rechargeable batteries with the fixing plate in the battery compartment (two screws) and replace the battery cover of the unit (one screw).

Tips on handling VRLA rechargeable batteries

- Charge the batteries completely before first use and with each charging process.
- Avoid deep discharge.
- Discharge the batteries at least once a month down to 20 % of the full capacity.
- Charge the batteries completely after each use and during storage at least every two months.
- The maximum storage time for VRLA rechargeable batteries without charge cycle is six months. After this period is exceeded, the affected batteries may be unusable and must be disposed of properly.

4.2 Remote control

Battery installation and replacement

When shipping, the battery is already installed in the remote and protected against discharge by a transparent plastic film. Remove the plastic film before initial use.

For replacing the battery, follow the instructions on the back of the remote control. Use only lithium button cells CR 2025. Note the correct polarity when inserting the battery.

4.3 Microphone

Battery installation and replacement

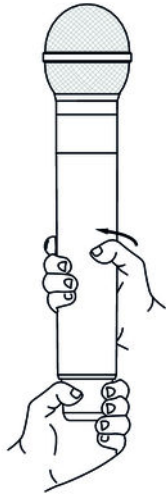

The battery compartment of the microphone is located under the handle sleeve and shares the same thread with the microphone capsule. To open the battery compartment and not to remove inadvertently the microphone capsule, hold the microphone with one hand at the edge of the antenna and rotate the handle sleeve like shown in the figure. After replacing the batteries close the housing. Please make sure that you tighten the handle sleeve not too much.

Use only LR6 AA (1.5 V) batteries or rechargeable Ni-MH batteries (nickel metal hydride). Note the correct polarity when inserting the batteries.

5 Connections and operating elements

Rear view - overview

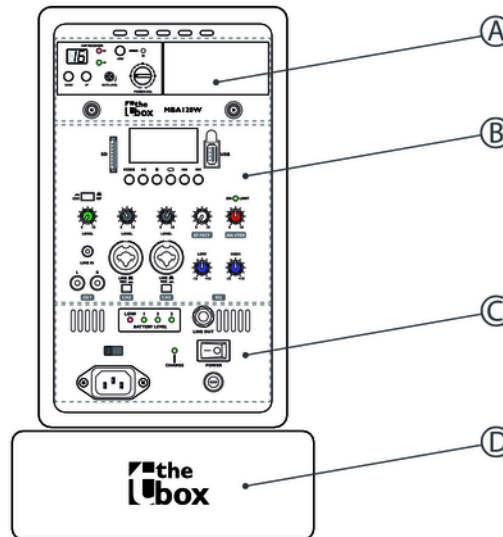

MBA120W

Partial view A

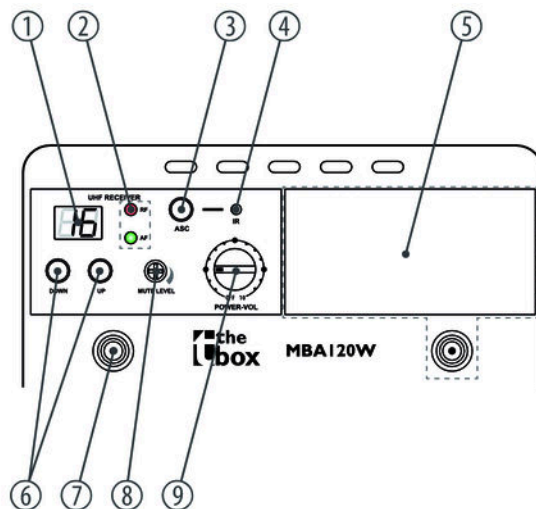

1	<p>Channel display. Double-digit display for selecting and displaying the radio transmission channel (range '01' ... '16').</p>
2	<p><i>[RF AF]</i> The red indicator LED <i>[RF]</i> lights up when a radio signal is transmitted between microphone and receiver. The green indicator LED <i>[AF]</i> lights up when an audio signal from an external device is present.</p>
3	<p><i>[ASC]</i> Press this button to transfer the channel setting from the device via the infrared port to the microphone.</p>
4	<p><i>[IR]</i> Infrared transmitter for transmitting the channel setting from the device to the microphone.</p>
5	<p>Additional compartment for a second receiver and second antenna jack. For mounting a second radio receiver loosen the two screws and remove the cover plate. The cables for power supply and signal transmission are already prepared and equipped with suitable plugs. Carefully loosen the cables out of the device housing and plug them to the corresponding connectors of the radio receiver. Place the second radio receiver in the compartment and fasten it with the two mounting screws. Keep the cover in a safe place.</p>

6	<p><i>[DOWN UP]</i></p> <p>Pushbutton for selecting the radio transmission channel.</p> <p>Proceed as follows to find a free channel:</p> <ul style="list-style-type: none">■ Turn the radio microphone (transmitter) and receiver (with the controller <i>[POWER-VOL]</i>) off.■ Use <i>[DOWN UP]</i> to click through the available channels. If the displayed channel is already in use, the red LED <i>[RF]</i>. <p>The first and (if applicable) second radio receiver must be tuned to different channels.</p>
7	<p>Antenna connector.</p>
8	<p><i>[MUTE LEVEL]</i></p> <p>Control to set the minimum signal strength on the radio transmission channel.</p>
9	<p><i>[POWER-VOL]</i></p> <p>On / off switch and volume control of the radio receiver.</p>

Partial view B

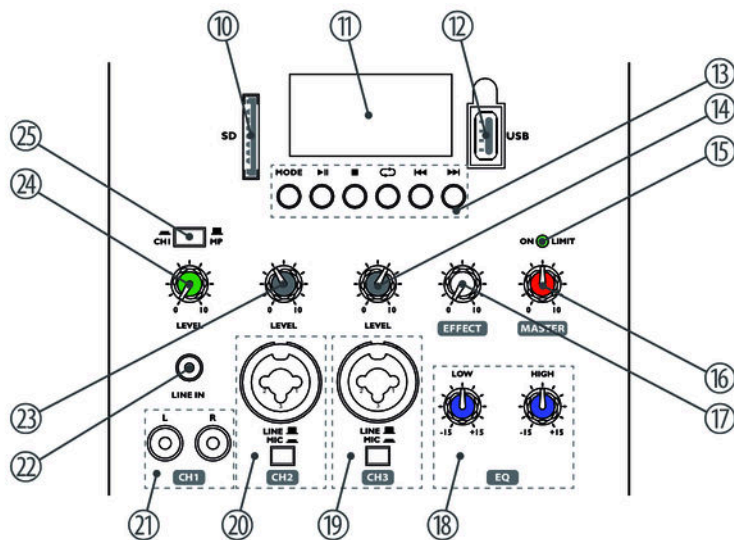

MBA120W

10	SD card slot.
11	Display (↩ 'Display' on page 34).
12	USB port.
13	Selection and control buttons:
	<i>[MODE]</i> Selection button. Press this button to select an audio source: SD card, USB input or Bluetooth port. The active source is shown on the display. For setting up and using the Bluetooth interface note ↩ 'Playback via Bluetooth' on page 42.
	▶ Depending on operating mode, Play / Pause button to start / stop playback or button to select a menu item.
	■ Stop button to stop playback.



Selection button. Press the button repeatedly to activate a playback mode. The active mode and the title of the current track will appear on the display:

- Normal 'N'. All tracks of the selected audio source are played in succession according to the MP3 file date. The prerequisite for this is that a subdirectory with the desired titles has been created on the data medium.
- Random 'R'. All tracks of the selected audio source are played in random order.
- Intro 'I'. The first ten seconds of each track of the selected audio source will be played.
- All 'A'. All tracks in endless loop, like Normal mode.
- Single '1'. Only the selected track is repeated in a loop.
- Folder 'F'. All tracks of a specific folder of the selected audio source are being played.



Depending on operating mode, Skip forward (to the next track) or switch to the next menu option.

Keep this button pressed to increase the volume of the internal media player.



Depending on operating mode, Skip backwards (to the previous track) or switch to the previous menu option.

Keep this button pressed to decrease the volume of the internal media player. We recommend to keep this volume at maximum value and adjust the volume with the [LEVEL] control (24).

14	<i>[LEVEL]</i> Gain control for channel 3. Use this control to adjust the level of the input signal in Channel 3.
15	<i>[ON LIMIT]</i> Indicator LED (green). This LED lights solid in normal operation and flickers when the box is overdriven. In this case, turn the gain control of the active channel down to reduce the level of the input signal.
16	<i>[MASTER]</i> Volume control. Use this control to adjust the overall volume of the device (sum of all input channels).
17	<i>[EFFECT]</i> Effects control. Use this control to adjust the amount of built-in Delay effect on the overall volume for all channels.
18	<i>[EQ LOW HIGH]</i> Equalizer. Controller for adjusting the high and low frequencies in a range of <i>[-15] ... [+15]</i> .
19	<i>[CH3]</i> Signal input for channel 3, designed as XLR / 1/4" combo socket, beneath toggle switch for LINE and MIC input signal level.

20	<i>[CH2]</i> Signal input for channel 2, designed as XLR / 1/4" combo socket, beneath switch between LINE and MIC input signal level.
21	<i>[CH1]</i> RCA input sockets to connect an external audio device to channel 1.
22	<i>[LINE IN]</i> 3.5 mm input socket to connect an external audio device to channel 1.
23	<i>[LEVEL]</i> Gain control for channel 2. Use this control to adjust the level of the input signal in Channel 2.
24	<i>[LEVEL]</i> Gain control for channel 1. Use this control to adjust the level of the input signal in Channel 1.
25	<i>[CHI MP]</i> Channel 1 input signal switch: external device via RCA sockets / 3.5 mm jack or built-in media player.

Partial view C

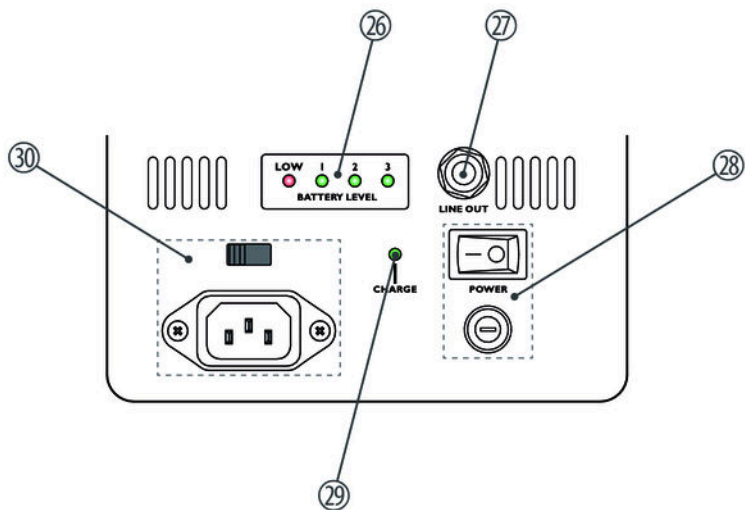

26	<p><i>[BATTERY LEVEL]</i></p> <p>State of charge indicators. All four LEDs light when batteries are fully charged. When capacity decreases, the green LEDs 3, 2 to 1 go out one by one. If only the red LED lights the remaining battery capacity is low. Then connect the device to the mains power to charge the batteries. Please refer to the instructions in section Chapter 4.1 'Battery operation' on page 18.</p>
27	<p><i>[LINE OUT]</i></p> <p>Line output (1/4" socket) to connect an amplifier, a PA or an additional speaker.</p>
28	<p><i>[POWER]</i></p> <p>On / off switch and fuse holder.</p>
29	<p><i>[CHARGE]</i></p> <p>This LED lights green during charging. Once the installed battery pack is fully charged, the LED turns off.</p>
30	<p>IEC chassis plug for power connection and mains voltage selector switch.</p> <p>Once the unit is connected to the mains, the built-in rechargeable batteries are being charged even when the power is off.</p>

Partial view D

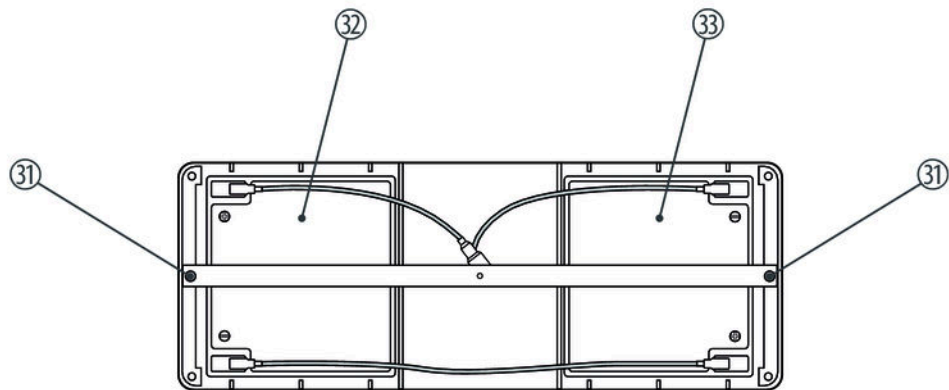

31 Mounting screws of the fixing plate.

32, 33 VRLA batteries 1 and 2.

Observe the correct polarity when wiring the batteries. Connect the red cable to the positive pole of battery 1 and the black cable to the negative pole of battery 2. Use the blue cable to connect the negative pole of battery 1 to the positive pole of battery 2.

Display

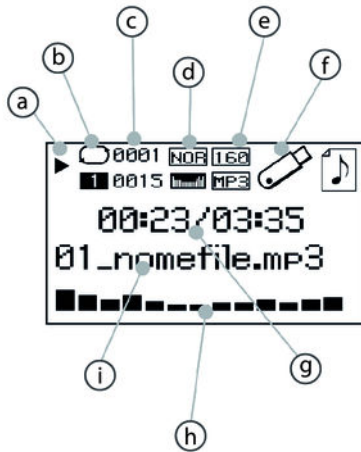

a	Play/Pause.
b	Endless loop.
c	Number of the currently playing track and number of tracks in the current folder.
d	Selected EQ setting.
e	Bit rate and file type of the currently playing track.
f	Symbol for the selected data source.
g	Elapsed time / total time of the currently playing track.
h	Frequency spectrum bar graph.
i	File name of the currently playing track.

Remote control

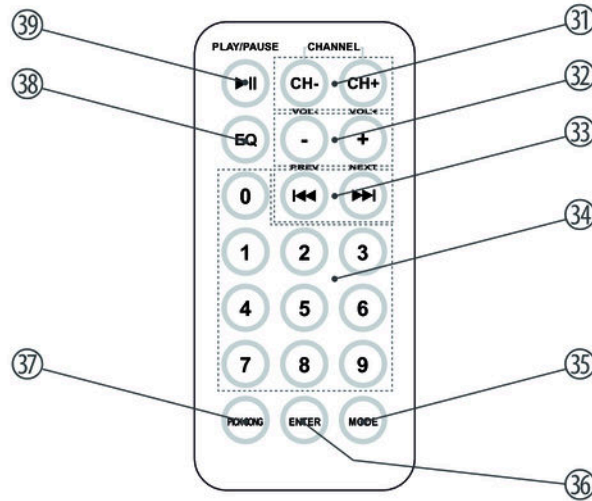

31	<i>[CHANNEL]</i> No function.
32	<i>[VOL- / VOL+]</i> To decrease or increase the volume.
33	<i>[PREV / NEXT]</i> Forward (skip to the next track) or backward (skip to the previous track).
34	Numeric keypad for direct access to tracks.
35	<i>[MODE]</i> Selection button. Press this button to select an audio source: SD card, USB input or Bluetooth port. The active source is shown on the display. For setting up and using the Bluetooth interface note ↪ <i>'Playback via Bluetooth' on page 42.</i>

36 *[ENTER]*

This button opens a menu with the following options:

- 'EQ' – selects an equalizer setting, corresponds to the key *[EQ]* on the remote.
- 'PLAY MODE' – selects a play mode, corresponds to the key *[↔]* on the unit.
- 'CHANGE DEVICE' – selects an audio source, corresponds to the key *[MODE]* on the remote.
- 'EXIT' – to exit the selection menu.

To navigate within the selection menu use *[PREV / NEXT]*. To select an option use *[PLAY/PAUSE]*.

37 *[PICK SONG]*

No function.

38 [EQ]

Selects an EQ setting:

- 'NOR' – Normal
- 'POP' – Pop music
- 'ROCK' – Rock music
- 'JAZZ' – Jazz
- 'CLAS' – Classic music
- 'COU' – Country music
- 'BAS' – Bass boost

39 [PLAY/PAUSE]

Play / pause button to start / stop playback.

Microphone

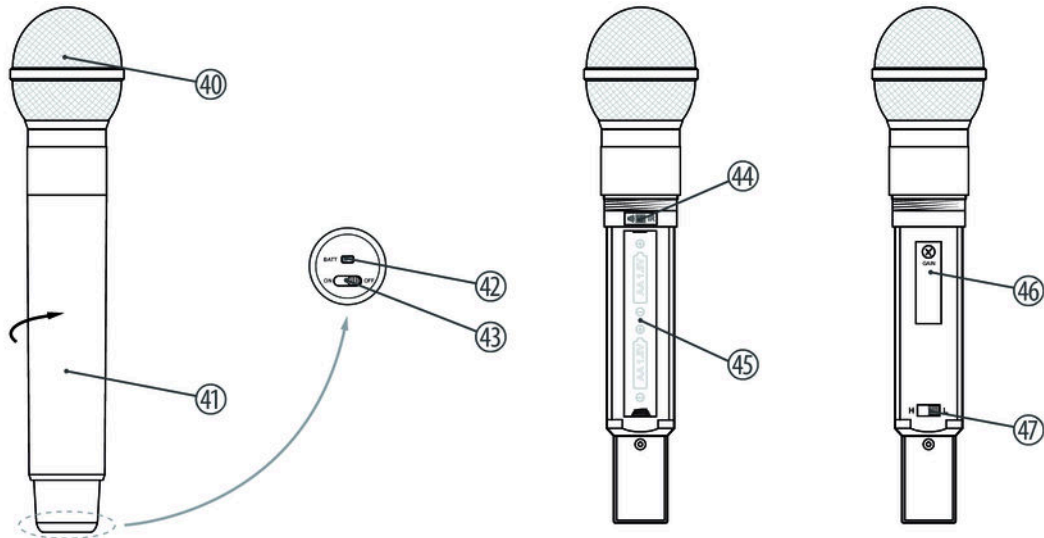

MBA120W

40	Microphone head grill to prevent damage and to reduce wind and breath noise.
41	Lower housing part. Unscrew to open.
42	<i>[BATT]</i> This LED shows the state of the batteries. When the microphone is turned on and the capacity of the battery is sufficient, the LED lights green. When the batteries are exhausted, the LED lights red.
43	<i>[ON/OFF]</i> Slide switch to turn the microphone on and off.
44	Infrared sensor for receiving the channel setting from the device to the microphone. The sensor is accessible after removal of the lower housing part. After each change, transfer the channel setting from the device to the microphone. Place the microphone as close as possible to the device and then press <i>[ASC]</i> . The <i>[RF]</i> LED lights up when the transmission was successful.
45	Battery compartment for 2 AA cells (LR6, 1.5 V) or appropriate rechargeable batteries.

46 [GAIN]

Control to adjust the microphone sensitivity.

47 [H/L]

Switch for selecting the transmission level. In 'L' position, a low level is used to save the batteries. As a result, the range is reduced to about 10 m. In 'H' position, a high level is used for an expanded transmission range (about 30 m). This reduces battery life.

Playback via Bluetooth

Establishing connection to Bluetooth device

Follow the instructions given in the manual of the Bluetooth device and turn it on. Place it near the device.

Press *[MODE]* and select the Bluetooth interface as the source for playback. After a few seconds your Bluetooth device is detected. The display shows the message *'BT Connected'*. If that doesn't work automatically, press **▶||** and start the synchronization from the Bluetooth device.

Bluetooth menu

Press and hold *[MODE]* pressed for a few seconds to open the Bluetooth menu.

To navigate within the menu use *[PREV/NEXT]*. To select an option use *[PLAY/PAUSE]*.

The menu offers the following options:

- *'Recently reconnection'* – re-connect to the last used Bluetooth device.
- *'EQ'*
 - *'Normal'* – Normal
 - *'Pop'* – Pop music
 - *'Rock'* – Rock music
 - *'Jazz'* – Jazz
 - *'Classic'* – Classic music
 - *'County'* – Country music

- *'Lowbass'* – Bass boost
- *'Deleted paired info'* – erases all information on last link with a Bluetooth device. Try this option to solve problems establishing a Bluetooth connection.
- *'Device Information'* – shows information about the name and address of the Bluetooth interface of the device on the display.
- *'Exit'* – to exit the menu.

6 Technical specifications

Amplifier / speaker		
Speaker	Two-way system with 1" compression driver and 10" woofer	
Input connections		2 × XLR / 1/4" combo socket for microphone / line input with switchable sensitivity
		1 × 3.5 mm jack as line input
		2 × RCA sockets for additional signal input, for CD players or similar devices with line out signal.
	USB port	USB A
	Power supply	IEC chassis plug C14
Output connection		1 × 1/4" phone socket for line output
Output power	120 W (mains operation)	
	80 W (battery operation)	

Frequency range	55 Hz ... 18 kHz, -3 dB
Radio link	
Carrier frequency	UHF band (863 MHz ... 865 MHz)
NF frequency response	60 Hz ... 16 kHz, -3 dB
Modulation type	Frequency modulation (FM)
Signal-to-noise ratio	> 100 dB
Transmission power	< 10 mW
THD	< 0.1 %
General	
Power consumption	43 W
Supply voltage	100 V~, 60 Hz / 230 V~, 50 Hz

	2 × 12 V lead-gel rechargeable batteries (VRLA batteries, 5 Ah each), maintenance-free	
	Recommended types:	
	<ul style="list-style-type: none"> ■ Ritar RT1250 ■ Fiamm FG20451 	
Fuse	115 V: 5 mm × 20 mm, 2 A, 250 V, slow-blow 230 V: 5 mm × 20 mm, 1 A, 250 V, slow-blow	
Operating time per battery charge	3 h ... 4 h	
Charging time	10 h ... 12 h	
Dimensions (W × H × D)	360 mm × 567 mm × 290 mm	
Weight	19 kg	
Ambient conditions	Temperature range	0 °C...40 °C
	Relative humidity	50 %, non-condensing

Further information

Player incl.	Yes
Microphone incl.	Yes
Subwoofer incl.	No
Cover incl.	No (optional, item no. 382254)

7 Plug and connection assignment

Introduction

This chapter will help you select the right cables and plugs to connect your valuable equipment in such a way that a perfect sound experience is ensured.

Please note these advices, because especially in 'Sound & Light' caution is indicated: Even if a plug fits into the socket, an incorrect connection may result in a destroyed power amp, a short circuit or 'just' in poor transmission quality!

Balanced and unbalanced transmission

Unbalanced transmission is mainly used in semi-professional environment and in hifi use. Instrument cables with two conductors (one core plus shielding) are typical representatives of the unbalanced transmission. One conductor is ground and shielding while the signal is transmitted through the core.

Unbalanced transmission is susceptible to electromagnetic interference, especially at low levels, such as microphone signals and when using long cables.

In a professional environment, therefore, the balanced transmission is preferred, because this enables an undisturbed transmission of signals over long distances. In addition to the conductors 'Ground' and 'Signal', in a balanced transmission a second core is added. This also transfers the signal, but phase-shifted by 180°.

Since the interference affects both cores equally, by subtracting the phase-shifted signals, the interfering signal is completely neutralized. The result is a pure signal without any noise interference.

1/4" TS phone plug (mono, unbalanced)



1	Signal
2	Ground, shielding

1/4" TRS phone plug (mono, balanced)



1	Signal (in phase, +)
2	Signal (out of phase, -)
3	Ground

Three-pole 1/8" mini phone jack (stereo, unbalanced)



1	Signal (left)
2	Signal (right)
3	Ground, shielding

XLR plug (balanced)

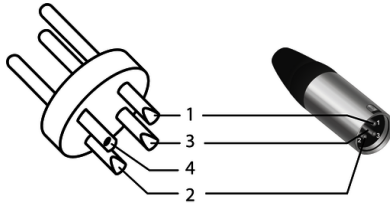

1	Ground, shielding
2	Signal (in phase, +)
3	Signal (out of phase, -)
4	Shielding on plug housing (option)

RCA connection

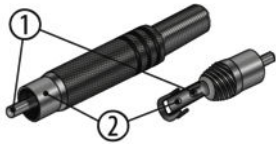

Drawing and table indicate the pin assignment of an RCA plug.

1	Signal
2	Ground, shielding

8 Cleaning

Device components

Clean the device components that are accessible from the outside regularly. The cleaning frequency depends on the operating environment: damp, smoky or particularly dirty environments can cause greater accumulation of dirt on the device components.

- Clean with a dry soft cloth.
- Stubborn dirt can be removed with a slightly dampened cloth.
- Never use solvents or alcohol for cleaning.

9 Protecting the environment

Disposal of the packaging material



For the transport and protective packaging, environmentally friendly materials have been chosen that can be supplied to normal recycling.

Ensure that plastic bags, packaging, etc. are properly disposed of.

Do not just dispose these materials with your normal household waste, but make sure that they are fed to a recovery. Please follow the notes and markings on the packaging.

Disposal of batteries



Batteries must not be disposed of as domestic waste or thrown into fire. Dispose of the batteries according to national or local regulations regarding hazardous waste. To protect the environment, dispose of empty batteries at your retail store or at appropriate collection sites.

Disposal of your old device



This product is subject to the European Waste Electrical and Electronic Equipment Directive (WEEE) in its currently valid version. Do not dispose with your normal household waste.

Dispose this device through an approved waste disposal firm or through your local waste facility. When discarding the device, comply with the rules and regulations that apply in your country. If in doubt, consult your local waste disposal facility.



