



LED Pad 144  
144×10 mm RGBW

LED PAR

Musikhaus Thomann  
Thomann GmbH  
Hans-Thomann-Straße 1  
96138 Burgebrach  
Germany  
Telephone: +49 (0) 9546 9223-0  
E-mail: [info@thomann.de](mailto:info@thomann.de)  
Internet: [www.thomann.de](http://www.thomann.de)

17.10.2017, ID: 369857

---

# Table of contents

<b>1</b>	<b>General notes</b> .....	<b>6</b>
	1.1 Further information.....	7
	1.2 Notational conventions.....	8
	1.3 Symbols and signal words.....	8
<b>2</b>	<b>Safety instructions</b> .....	<b>11</b>
<b>3</b>	<b>Features</b> .....	<b>16</b>
<b>4</b>	<b>Installation</b> .....	<b>17</b>
<b>5</b>	<b>Starting up</b> .....	<b>21</b>
<b>6</b>	<b>Connections and controls</b> .....	<b>23</b>
<b>7</b>	<b>Operating</b> .....	<b>29</b>
	7.1 Starting the device.....	29
	7.2 Operating on the unit.....	29
	7.3 IR remote control.....	31
	7.4 Menu overview.....	32
	7.5 Functions in DMX mode.....	33

<b>8</b>	<b>Technical specifications.....</b>	<b>35</b>
<b>9</b>	<b>Plug and connection assignments.....</b>	<b>36</b>
<b>10</b>	<b>Troubleshooting.....</b>	<b>37</b>
<b>11</b>	<b>Cleaning.....</b>	<b>39</b>
<b>12</b>	<b>Protecting the environment.....</b>	<b>40</b>



LED Pad 144 144x10 mm RGBW  
LED PAR

## 1 General notes

This manual contains important instructions for the safe operation of the unit. Read and follow the safety instructions and all other instructions. Keep the manual for future reference. Make sure that it is available to all those using the device. If you sell the unit please make sure that the buyer also receives this manual.

Our products are subject to a process of continuous development. Thus, they are subject to change.

## 1.1 Further information

On our website ([www.thomann.de](http://www.thomann.de)) you will find lots of further information and details on the following points:

Download	This manual is also available as PDF file for you to download.
Keyword search	Use the search function in the electronic version to find the topics of interest for you quickly.
Online guides	Our online guides provide detailed information on technical basics and terms.
Personal consultation	For personal consultation please contact our technical hotline.
Service	If you have any problems with the device the customer service will gladly assist you.

## 1.2 Notational conventions

This manual uses the following notational conventions:

### Letterings

The letterings for connectors and controls are marked by square brackets and italics.

**Examples:** *[VOLUME]* control, *[Mono]* button.

### Displays



Texts and values displayed on the device are marked by quotation marks and italics.

**Examples:** *'24ch'*, *'OFF'*.

## 1.3 Symbols and signal words

In this section you will find an overview of the meaning of symbols and signal words that are used in this manual.



Signal word	Meaning
<b>DANGER!</b>	This combination of symbol and signal word indicates an immediate dangerous situation that will result in death or serious injury if it is not avoided.
<b>WARNING!</b>	This combination of symbol and signal word indicates a possible dangerous situation that can result in death or serious injury if it is not avoided.
<b>NOTICE!</b>	This combination of symbol and signal word indicates a possible dangerous situation that can result in material and environmental damage if it is not avoided.
Warning signs	Type of danger
	Warning – high-voltage.
	Warning – suspended load.

Warning signs	Type of danger
	Warning – danger zone.

## 2 Safety instructions

### Intended use

This device is intended to be used as an electronic illumination effect using LED technics. The device is designed for professional use and is not suitable for use in households. Use the device only as described in this user manual. Any other use or use under other operating conditions is considered to be improper and may result in personal injury or property damage. No liability will be assumed for damages resulting from improper use.

This device may be used only by persons with sufficient physical, sensorial, and intellectual abilities and having corresponding knowledge and experience. Other persons may use this device only if they are supervised or instructed by a person who is responsible for their safety.

### Safety



#### **DANGER!**

##### **Danger for children**

Ensure that plastic bags, packaging, etc. are disposed of properly and are not within reach of babies and young children. Choking hazard!

Ensure that children do not detach any small parts (e.g. knobs or the like) from the unit. They could swallow the pieces and choke!

Never let children unattended use electrical devices.



#### **DANGER!**

##### **Electric shock caused by high voltages inside**

Within the device there are areas where high voltages may be present. Never remove any covers.

There are no user-serviceable parts inside.

Do not use the device if covers, protectors or optical components are missing or damaged.



**DANGER!**

**Electric shock caused by short-circuit**

Always use proper ready-made insulated mains cabling (power cord) with a protective contact plug. Do not modify the mains cable or the plug. Failure to do so could result in electric shock/death or fire. If in doubt, seek advice from a registered electrician.



**WARNING!**

**Eye damage caused by high light intensity**

Never look directly into the light source.



**WARNING!**

**Risk of epileptic shock**

Strobe lighting can trigger seizures in photosensitive epilepsy. Sensitive persons should avoid looking at strobe lights.



### **NOTICE!**

#### **Risk of fire**

Do not block areas of ventilation. Do not install the device near any direct heat source. Keep the device away from naked flames.



### **NOTICE!**

#### **Operating conditions**

This device has been designed for indoor use only. To prevent damage, never expose the device to any liquid or moisture. Avoid direct sunlight, heavy dirt, and strong vibrations.



**NOTICE!**

**Power supply**

Before connecting the device, ensure that the input voltage (AC outlet) matches the voltage rating of the device and that the AC outlet is protected by a residual current circuit breaker. Failure to do so could result in damage to the device and possibly injure the user.

Unplug the device before electrical storms occur and when it is unused for long periods of time to reduce the risk of electric shock or fire.

### 3 Features

The device is suitable for almost all applications, for example in clubs, bars, small stages and theatres. It is characterized by compact dimensions and maximum flexibility.

Special features of the device:

- 144 × colour LEDs, each 10 mm (36 × red, 48 × green, 36 × blue, 24 × white)
- with double bracket for easy setup or mounting
- Control via DMX, buttons and display on the unit as well as via remote control (included)
- Automatic mode and sound control
- Master / Slave operation



## 4 Installation

Unpack and carefully check that there is no transportation damage before using the unit. Keep the equipment packaging. To fully protect the device against vibration, dust and moisture during transportation or storage use the original packaging or your own packaging material suitable for transport or storage, respectively.



### **WARNING!**

#### **Risk of injury caused by falling objects**

Make sure that the installation complies with the standards and rules that apply in your country. Always secure the device with a secondary safety attachment, such as a safety cable or a safety chain.



### **NOTICE!**

#### **Risk of overheating**

Always ensure sufficient ventilation.

The ambient temperature must always be below 40 °C (104 °F).



### **NOTICE!**

#### **Use of stands**

When mounting the device onto a stand, ensure that the stand is in a safe and stable position and that the weight of the device does not exceed the maximum permissible load capacity of the stand.

**NOTICE!****Possible data transmission errors**

For error-free operation make use of dedicated DMX cables and do not use ordinary microphone cables.

Never connect the DMX input or output to audio devices such as mixers or amplifiers.

**Mounting options**

You can install the unit in hanging or standing position. When in use, the device must always be attached to a solid surface or an approved truss. Use the openings provided on the two-piece bracket for attaching.

Always work from a stable platform whenever installing, moving or servicing the unit. In doing so, the area underneath the unit must be cordoned off.

The safety-rope must be attached to the bracket.



*Please note that this device must not be connected to a dimmer.*

## 5 Starting up

Create all connections while the device is off. Use the shortest possible high-quality cables for all connections. Take care when running the cables to prevent tripping hazards.

### Connections in DMX mode

Connect the DMX input of the device to the DMX output of a DMX controller or another DMX device. Connect the output of the first DMX device to the input of the second one, and so on to form a daisy chain. Always ensure that the output of the last DMX device in the daisy chain is terminated with a resistor ( $110\ \Omega$ ,  $\frac{1}{4}\text{ W}$ ).

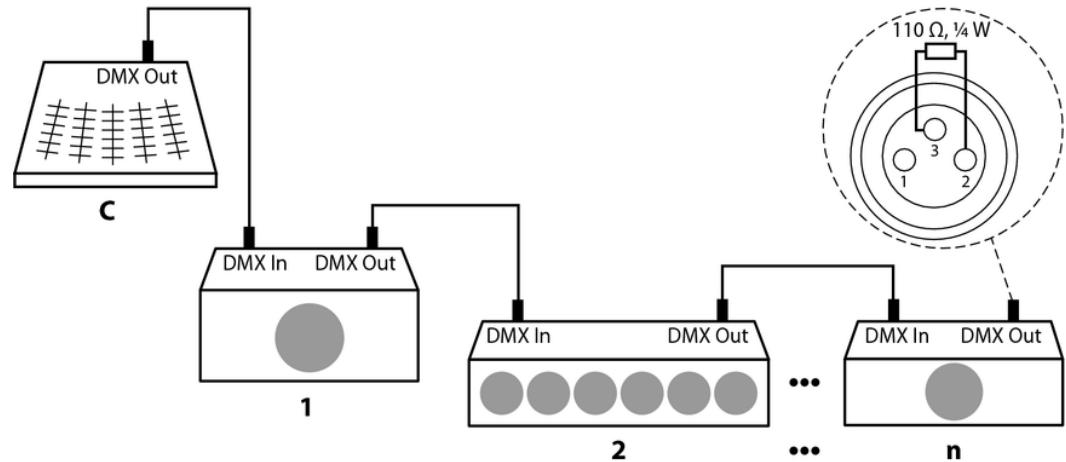

## 6 Connections and controls

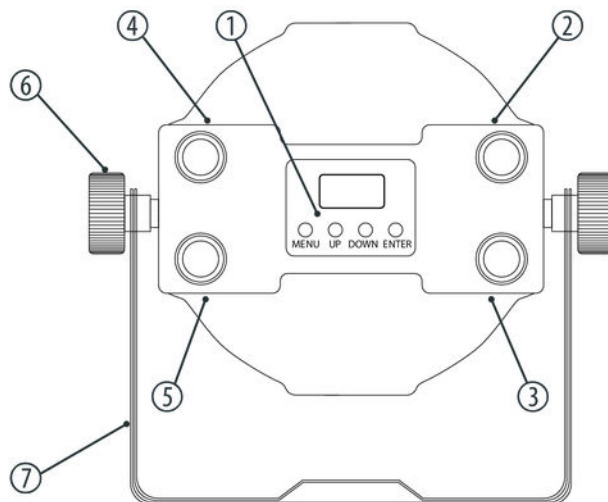

1 Display and function buttons.

*[ENTER]*

Confirms a selected value.

*[DOWN]*

Button to decrease the displayed value by one.

*[UP]*

Button to increase the displayed value by one.

*[MENU]*

Calls up the main menu or a submenu.

2 DMX input.

3 DMX output

4 Plug for mains cable.

5 Connection for the power cable to supply additional devices.



6 Locking screws for the mounting bracket.

7 Bracket for floor placement or hanging.

## Remote control

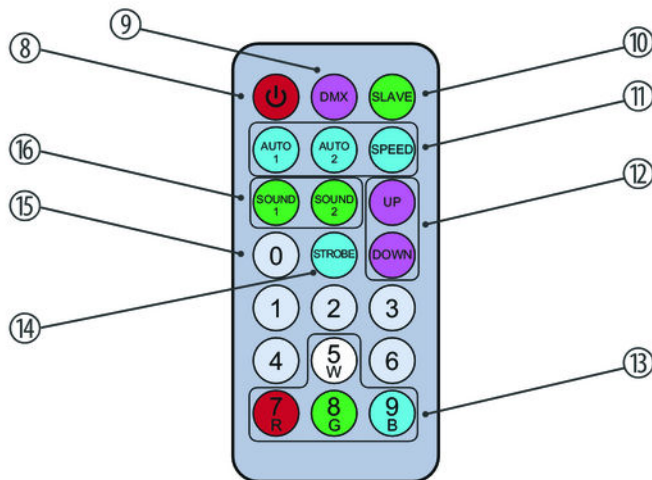

8	Button to turn the device on and off.
9	<i>[DMX]</i> Button to switch between DMX and stand-alone mode.
10	<i>[SLAVE]</i> Button to switch between master and slave mode.
11	<i>[AUTO 1], [AUTO 2], [SPEED]</i> Buttons to activate automatic mode 1 or 2 and to adjust the programme speed.
12	<i>[UP], [DOWN]</i> Buttons to switch between programmes and to increase / decrease numeric values.
13	Buttons for colour selection. Use <ul style="list-style-type: none"><li>■ <i>[W]</i> for white light.</li><li>■ <i>[R], [G]</i> or <i>[B]</i> for primary colours red, green and blue.</li></ul>

- |    |   |
|----|---|
| 14 | <i>[STROBE]</i><br>Button to turn the strobe effect on or off.                |
| 15 | Numeric buttons 0 ... 9 for direct value input.                               |
| 16 | <i>[SOUND 1], [SOUND 2]</i><br>Buttons to activate sound-control mode 1 or 2. |

## 7 Operating

### 7.1 Starting the device

Turn on the power using the main switch. After a few seconds, the fan starts. The display shows the current operation mode.

### 7.2 Operating on the unit

#### DMX mode, DMX address

Press *[MENU]*, *[UP]* or *[DOWN]* repeatedly until the display shows 'Addr'. Confirm with *[ENTER]*.

Now you can set the number of the first DMX channel to be used by the device (DMX address). Use *[UP]* and *[DOWN]* to select a value between 1 and 512 (the display shows 'A001' ... 'A512'). Confirm with *[ENTER]*.

#### Sound control

Press *[MENU]*, *[UP]* or *[DOWN]* repeatedly until the display shows 'Soun'. Confirm with *[ENTER]*.

Use *[UP]* and *[DOWN]* to select the desired mode 'Sou1' or 'Sou2'. Confirm with *[ENTER]*.

### **Operating mode Auto**

Press *[MENU]*, *[UP]* or *[DOWN]* repeatedly until the display shows 'Auto'. Confirm with *[ENTER]*.

Use *[UP]* and *[DOWN]* to select the desired mode 'Aut1' or 'Aut2'. Confirm with *[ENTER]*. Now you can adjust the progress speed of the programme between 'SP 1' and 'SP 9'.

### **Constant colour**

Press *[MENU]*, *[UP]* or *[DOWN]* repeatedly until the display shows 'Colo'. Confirm with *[ENTER]*.

Use *[UP]* and *[DOWN]* to select a constant colour in the range of 'Col1' ... 'Col9' or the option 'AtF'. Confirm with *[ENTER]*

In AtF mode, you can create custom colour blends by adjusting the red, green, blue, and white colour intensities in a range of '1' ... '255'. Confirm each colour setting with *[ENTER]* to move to the next colour in the menu.

### **Operating mode Slave**

Press *[MENU]*, *[UP]* or *[DOWN]* repeatedly until the display shows 'SLav'. Confirm with *[ENTER]*.

The display shows 'Sla', the unit is now in Slave mode.

### **Showing software version**

Press *[MENU]*, *[UP]* or *[DOWN]* repeatedly until the display shows 'uer'. Confirm with *[ENTER]*.

The display shows the version number of the currently installed software.

## 7.3 IR remote control

Press *[MENU]*, *[UP]* or *[DOWN]* repeatedly until the display shows 'rEno'. Confirm with *[ENTER]*.

Use *[UP]* and *[DOWN]* to select the option 'on' to enable IR remote control. Confirm with *[ENTER]*.

## 7.4 Menu overview

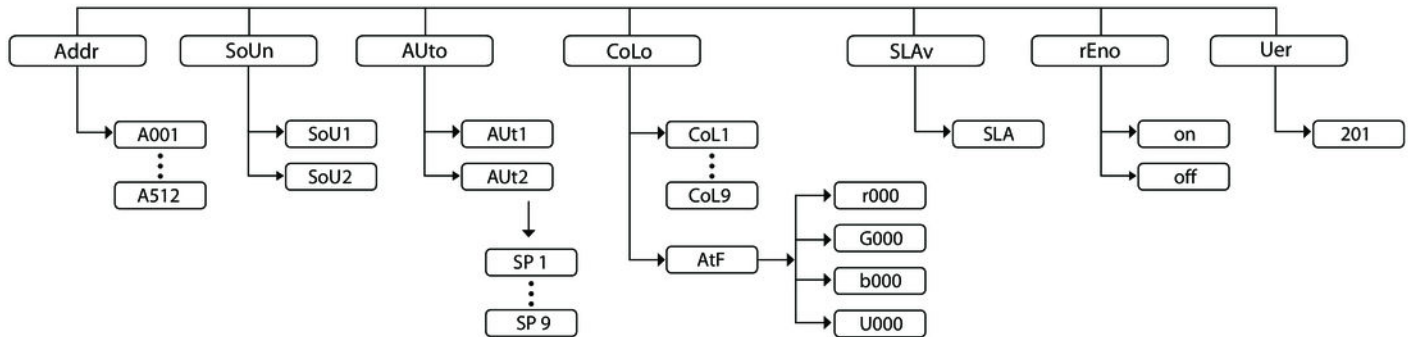



## 7.5 Functions in DMX mode

Channel	Value	Function
1	0...255	Master dimmer (0 % to 100 %)
2	0...255	Intensity red (0 % to 100 %)
3	0...255	Intensity green (0 % to 100 %)
4	0...255	Intensity blue (0 % to 100 %)
5	0...255	Intensity white (0 % to 100 %)
6	0...255	Stroboscope effect (slow to fast)
7	0...15	No function
	16...31	Colour mixing with transition 1
	32...47	Colour mixing with transition 2
	48...63	Colour mixing with transition 3
	64...79	Colour mixing with transition 4

Channel	Value	Function
	80...95	Colour mixing with transition 5
	96...111	Strobe effect
	112...127	Colour change with fade effect
	128...143	Colour change
	144...159	Colour change with strobe effect
	160...175	Fading out with colour change
	176...191	Fading in with colour change
	192...207	Fading out, fading in
	208...223	Colour change
	224...239	Sound mode 1
	240...255	Sound mode 2

## 8 Technical specifications

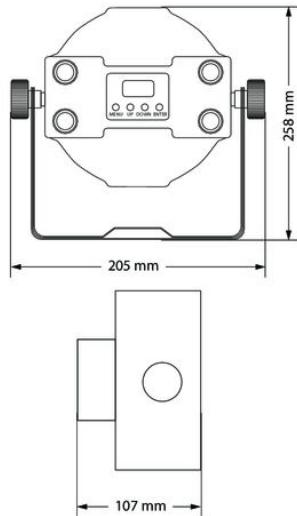

LEDs	144 × colour LEDs, each 10 mm (36 × red, 48 × green, 36 × blue, 24 × white)
Number of DMX channels	7
Power consumption	20 W
Operating supply voltage	AC 100 – 240 V ~ 50/60 Hz
Fuse	5 mm × 20 mm, 1 A, 250 V, fast-acting
Housing colour	black
Dimensions (W × H × D)	205 × 258 × 107 mm (incl. bracket)
Weight	1.5 kg

## 9 Plug and connection assignments

### Introduction

This chapter will help you select the right cables and plugs to connect your valuable equipment so that a perfect light experience is guaranteed.

Please take our tips, because especially in 'Sound & Light' caution is indicated: Even if a plug fits into a socket, the result of an incorrect connection may be a destroyed DMX controller, a short circuit or 'just' a not working light show!

### DMX connections

The unit offers a 3-pin XLR socket for DMX output and a 3-pin XLR plug for DMX input. Please refer to the drawing and table below for the pin assignment of a suitable XLR plug.



Pin	Configuration
1	Ground, shielding
2	Signal inverted (DMX-, 'cold signal')
3	Signal (DMX+, 'hot signal')

## 10 Troubleshooting



### **NOTICE!**

#### **Possible data transmission errors**

For error-free operation make use of dedicated DMX cables and do not use ordinary microphone cables.

Never connect the DMX input or output to audio devices such as mixers or amplifiers.

In the following we list a few common problems that may occur during operation. We give you some suggestions for easy troubleshooting:

Symptom	Remedy
The unit does not work, no light	Check the mains connection.
Apparently no function despite proper power supply	Check if the unit is in DMX mode or in 'slave' mode. If so, check the unit in another mode.
No response to the DMX controller	1. Check whether the DMX controller is switched on. Check the DMX connectors and cables for proper connection.
	2. Check the address settings and the DMX polarity.
	3. Try using another DMX controller.
	4. Check whether the DMX cables run near or parallel to high-voltage cables that may cause damage or interference to a DMX interface circuit.

If the procedures recommended above do not succeed, please contact our Service Center. You can find the contact information at [www.thomann.de](http://www.thomann.de).

## 11 Cleaning

### Optical lenses

Clean the optical lenses, that are accessible from the outside, regularly in order to optimize the light output. The frequency of cleaning depends on the operating environment: wet, smoky or particularly dirty surroundings can cause more accumulation of dirt on the optics of the device.

- Clean with a soft cloth using our lamp and lens cleaner (item no. 280122).
- Always dry the parts carefully.

### Fan grids

The fan grids of the device must be cleaned on a regular basis to remove dust and dirt. Before cleaning, switch off the device and disconnect AC-powered devices from the mains. Use a lint-free damp cloth for cleaning. Never use solvents or alcohol for cleaning.

## 12 Protecting the environment

### Disposal of the packaging material



For the transport and protective packaging, environmentally friendly materials have been chosen that can be supplied to normal recycling.

Ensure that plastic bags, packaging, etc. are properly disposed of.

Do not just dispose these materials with your normal household waste, but make sure that they are fed to a recovery. Please follow the notes and markings on the packaging.

### Disposal of batteries



Batteries must not be disposed of as domestic waste or thrown into fire. Dispose of the batteries according to national or local regulations regarding hazardous waste. To protect the environment, dispose of empty batteries at your retail store or at appropriate collection sites.



### Disposal of your old device



This product is subject to the European Waste Electrical and Electronic Equipment Directive (WEEE). Do not dispose with your normal household waste.

Dispose this device through an approved waste disposal firm or through your local waste facility. When discarding the device, comply with the rules and regulations that apply in your country. If in doubt, consult your local waste disposal facility.





