

# Operation Manual

Mixing Amplifier  
**PMU-60N/120N/240N**



**interM**

# Welcome

## A personal welcome to you from the management and employees of Inter-M

All of the co-workers here at Inter-M are dedicated to providing excellent products with inherently good value, and we are delighted you have purchased one of our products.

We sincerely trust this product will provide years of satisfactory service, but if anything is not to your complete satisfaction, we will endeavor to make things right.

Welcome to Inter-M, and thank you for becoming part of our worldwide extended family!



This symbol is intended to alert the user to the presence of uninsulated "dangerous voltage" within the product's enclosure that may be of sufficient magnitude to constitute a risk of electric shock to persons.



This symbol is intended to alert the user to the presence of important operation and maintenance (servicing) instructions in the literature accompanying the appliance.

Caution: To prevent electric shock do not use this (polarized) plug with an extension cord, receptacle or other outlet unless the blades can be fully inserted to prevent blade exposure.

Attentions: Pour prévenir les chocs électriques ne pas utiliser cette fiche polarisée avec un prolongateur, une prise de courant on une autre sortie de courant, sauf si les lames peuvent être insérées à fond sans en laisser aucune partie à découvert.  
Pour deconnecter complètement l'appareil du reseau d'alimentation. deconnecter le cordon d'alimentation de la prise murale.  
La prise du reseau d'alimentation doit demeurer aisement accessible.

## WARNING

To prevent fire or shock hazard, do not expose the unit to rain or moisture.

\*WARNING FOR YOUR PROTECTION PLEASE READ THE FOLLOWING-WATER AND MOISTURE: Unit should not be used near water(e.g. near a bathtub, washbowl, kitchen sink, laundry tub, in a wet basement, or near a swimming pool, etc). Care should be taken so than objects do not fall and liquids are not spilled into the enclosure through openings.

\*CLASS 2 WIRING (Adjacent to speaker terminal): The speaker output of this apparatus can exceed 10 Watts and could be a shock injury. Connection to speakers should be performed by a skilled person.

\*Do not install this equipment in a confined space such as a book case or similar unit.

\*Warning : To reduce the risk of fire or electric shock, do not expose this apparatus to rain or moisture and objects filled with liquids, such as vases, should not be placed on this apparatus.

\*This apparatus shall be connected to a mains socket outlet with a protective earthing connection.

\*To completely disconnect this apparatus from the AC mains, disconnect the power supply cord plug from the AC receptacle.

\*The mains plug of the power supply cord shall remain readily accessible.

## CAUTION

\*These servicing instructions are for use by qualified service personnel only. To reduce the risk of electric shock, do not perform any servicing other than that contained in the operating instructions unless you are qualified to do so.

## NOTE

\*This equipment has been tested and found to comply with the limits for a Class A digital device, pursuant to Part 15 of the FCC Rules. These limits are designed to provide reasonable protection against harmful interference when the equipment is operated in a commercial environment. This equipment generates, uses, and can radiate radio frequency energy and, if not installed and used in accordance with the instruction manual, may cause harmful interference to radio communications. Operation of this equipment in a residential area is likely to cause harmful interference in which case the user will be required to correct the interference at his own expense.

# Contents

<b>Unpacking</b> .....	2
<b>Installation</b>	
Environment .....	2
Important Safety Instructions .....	2
<b>Features</b> .....	3
<b>Operation</b> .....	3
<b>Front Panel</b> .....	4
<b>Rear Panel</b> .....	10
<b>Web Setting</b> .....	13
I. Accessing PMU-N Series Web-page .....	13
II. Network Setup .....	13
III. Operation Mode Setup .....	14
IV. I-Radio Setup .....	15
V. AOE-Connection Setup .....	16
VI. Time Setup .....	17
VII. View Log .....	18
VIII. System Management .....	19
<b>Speaker Connection</b> .....	20
<b>System Connection</b> .....	22
<b>Block Diagram</b> .....	23
<b>Specifications</b> .....	24
<b>Service</b>	
Procedures .....	26
Schematic .....	26
Parts List .....	26
<b>Variations and Options</b> .....	26
<b>Warranty</b> .....	26

## Unpacking

Although your PMU-60N/120N/240N is neither complicated nor difficult to operate, we recommend you take a few minutes to read this brief manual and familiarize yourself with the important information regarding product features, setup and operation.

As with most electronic devices, we strongly recommend you retain the original packaging. In the unlikely event the product must be returned for servicing, the original packaging (or reasonable equivalent) is required.

## Installation

### Environment

Never place this product in an environment which could alter its performance or reduce its service life. Such environments usually include high levels of heat, dust, moisture, and vibration.

## IMPORTANT SAFETY INSTRUCTIONS

1. Read these instructions.
2. Keep these instructions.
3. Heed all warnings.
4. Follow all instructions.
5. Do not use this apparatus near water.
6. Clean only with dry cloth.
7. Do not block any ventilation openings. Install in accordance with the manufacturer's instructions.
8. Do not install near any heat sources such as radiators, heat registers, stoves, or other apparatus (including amplifiers) that produce heat.
9. Do not defeat the safety purpose of the polarized or grounding-type plug. A polarized plug has two blades with one wider than the other. A grounding type plug has two blades and a third grounding prong. The wide blade or the third prong are provided for your safety. If the provided plug does not fit into your outlet, consult an electrician for replacement of the obsolete outlet.
10. Protect the power cord from being walked on or pinched particularly at plugs, convenience receptacles, and the point where they exit from the apparatus.
11. Only use attachments/accessories specified by the manufacturer.
12. Use only with the cart, stand, tripod, bracket, or table specified by the manufacturer, or sold with the apparatus. When a cart is used, use caution when moving the cart/apparatus combination to avoid injury from tip-over.
13. Unplug this apparatus during lightning storms or when unused for long periods of time.
14. Refer all servicing to qualified service personnel. Servicing is required when the apparatus has been damaged in any way, such as power-supply cord or plug is damaged, liquid has been spilled or objects have fallen into the apparatus, the apparatus has been exposed to rain or moisture, does not operate normally, or has been dropped.



## Features

- **Internet Radio**  
Plays internet radio over the network.
- **AOE-212N streaming**  
By connecting with Inter-M's network audio streamer (AOE-212N), plays the audio streaming data in real time.
- **USB Memory playback (MP3, WAV)**  
Plays sound sources in USB memory stick.
- **USB Audio Stream**  
Plays the sound of connected PC
- **2.8" Color TFT LCD**  
Displays the output level, playback and system information
- **2U Size**
- **60W / 120W / 240W output power**
- **SMPS delivers high power output with low power consumption and weight reduction**
- **5 Microphone/Line Inputs, EXT IN and TELL IN with individual volume control**
- **Input Level LED Monitor per channel**
- **Separate BASS/TREBLE Tone Controls**
- **5 zone selection switches**
- **Independent built-in Attenuator over Zone 5**
- **PRIORITY**
- **Remote MUTE and CHIME terminal**
- **VCA Remote volume control**

## Operation

1. Make sure the power switch on the front of the unit is set to off and connect the power cord to the mains outlet. Please set each input volume control to minimum position and set the tone controls to 0dB before turning on the power switch.
2. Make sure the speaker cables and input cables are properly connected.
3. Before connecting power, always check the voltage of main power supply. (AC 220V or AC 110V)
4. After completing all connections, turn on the power switch, and check to confirm that the power indicator lights.
5. Use input level control for corresponding to desired mixing volume levels and set the output level with master volume control.
6. Use the Treble/Bass tone controls to change the tone of the output source.

## Front Panel

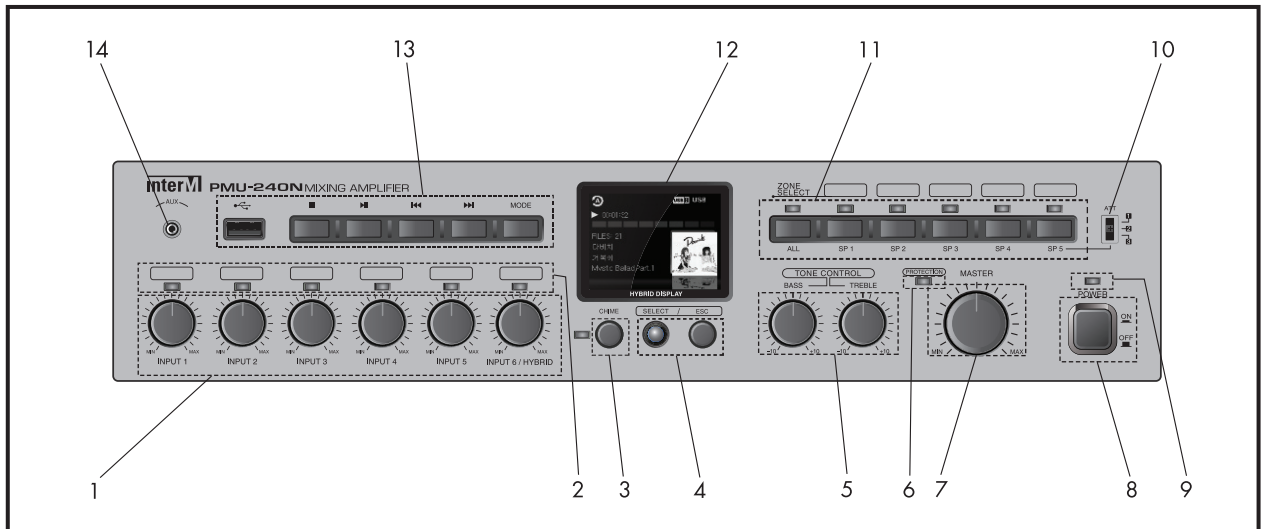

### 1. INPUT LEVEL CONTROL

Controls the level of each of the six input channels.

### 2. INPUT SIGNAL INDICATOR

These LEDs light green when input signal is present.

### 3. CHIME SWITCH

It activates the four tone chime circuitry. The chime indicator lights green when chime is on use.

### 4. ROTARY ENCODER CONTROL PROGRAM SELECTION DISPLAYED ON THE LCD DISPLAY

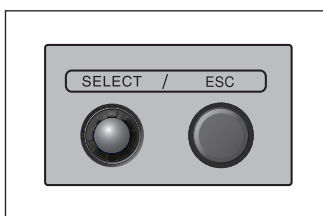

#### - SELECT

The select button activates MENU mode when pressed and held for a few seconds, then it is used as the select button during menu navigation.

#### - ESC

It used to return to the OPERATION MODE from the MENU MODE

### 5. TONE CONTROL

Controls the bass (100Hz) and treble (10KHz) tones of the main amplifier output.

**6. PROTECTION MODE INDICATOR**

Indicated that the amplifier is in failure protection mode.

**7. MASTER VOLUME CONTROL**

The master volume control to collectively control the sound level of all outputs and by turning the knob clockwise to increase the volume and counterclockwise to decrease it.

**8. POWER SWITCH****9. POWER INDICATOR**

This LED Lights green when the unit is powered on.

**10. ATTENUATOR**

Built-in ATTENUATOR over zone 5, It allows to decrease the output volume independently from master volume.

Mode	100V Output	70V Output
Switch mode 1	100V	70V
Switch mode 2	70V	49V
Switch mode 3	50V	35V

**11. ZONE SELECTION SWITCH**

Use the zone selection switches to route the program audio from the amplifier output to speaker zone 1 through zone 5. The All button controls turns ON/OFF all zones. The Indicators lights on when zone selection switches indicates if the zone is on.

**12. LCD OPERATION DISPLAY**

Displays the output level meter, each bar is marked in intervals of 3 to 5dB.

**1) MENU MODE**

<Menu Selection Screen>

- Menu selection screen will be shown by pressing and holding the select button, choose the menu by turning the select knob to the right or left then select the desired menu by pressing select button briefly.



**USB PLAYBACK MODE**  
USB Memory Playback,  
USB Audio Stream



**NETWORK BGM**  
Real time music broadcasting  
(service is in preparation).



**AOE STREAM MODE**  
Real time data transferring with  
AOE over the network.



**SETUP**  
Display system information and  
firmware version.



**INTERNET RADIO**  
Playing Internet Radio.

## 2) USB Play Mode

Plays the sound sources of USB memory stick.



	Play Mode Icon (single, single repeat, folder, folder repeat, play all, repeat all)
	Input source display - AOE Stream Receiver, Internet Radio, USB
	Output level meter display
	Displays USB connection status  Displays number of folder and file Displays the information of song

※ Caution : Downloaded sound source through some unclear path might not be able to support seamless playback.  
 Illegal distribution of sound file such as MP3 is prohibited by the law.  
 Please use the sound source that downloaded through the legal path.



### 3) Internet Radio

Plays internet radio with radio station's URL through network connection.

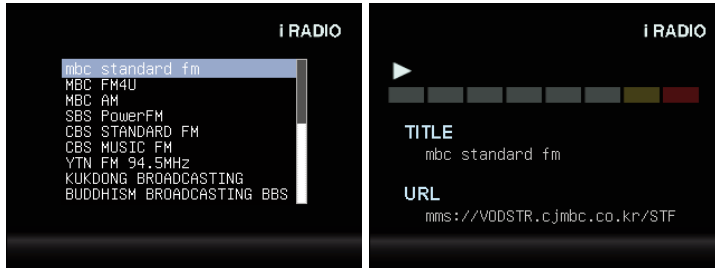

< radio list & radio main >

	Displays Broadcasting station.
<b>TITLE</b> ADO FM	Output level meter display.
<b>URL</b> ast.infomaniak.net:80/start-ado	Displays the URL of broadcasting station.

By pressing the select button briefly, the station lists are displayed as shown below.

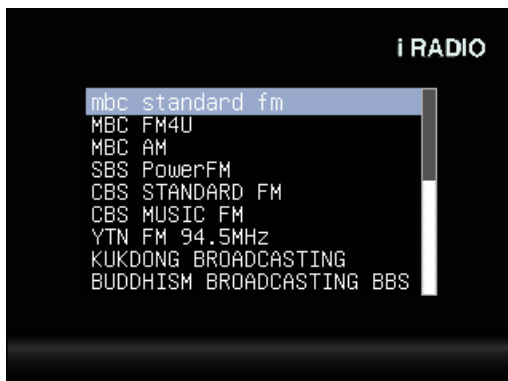

Choose the desired station by turning the select button to right or left then press the select button briefly to play the station you select.

※ The internet radio station will be set through web page and you may not be able to receive the broadcast when the station is no longer in service or doesn't exist.

To set the internet radio, please refer to section of web setting '4. internet radio setting'.

4) AOE stream

By connecting with Inter-M's network audio streamer (AOE-212N), plays the audio streaming data in real time over the network.



<AOE Stream mode screen>



<AOE Stream play mode screen>



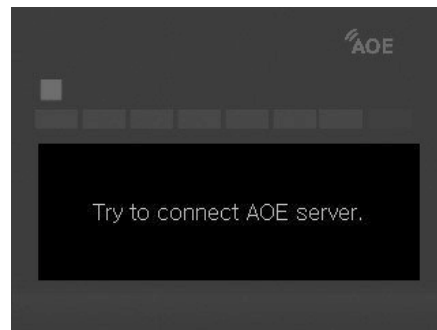

<When AOE's sample rate is more than 16kHz>



<AOE connection error screen>

※ Caution : for the reliable operation of AOE streaming, the sample rate of AOE -212N is recommended to set as 16000Hz.

 / 	Display the connection status of AOE
	Displays the output level
SERVER IP ADDRESS 192.168.1.142 SAMPLE RATE 16000 Hz	Displays the server address of AOE-212N, The server setting can be changed through web page.

※ AOE setting : Please refer to the section of web setting '5. Aoe Stream'.

## 5) System Information Screen

SYSTEM INFORMATION	
MAC ADDRESS	00:1D:1D:01:07:80
DHCP	no
IP ADDRESS	192.168.1.99
GATEWAY	192.168.1.1
NETMASK	255.255.255.0
DNS 1	168.126.63.1
DNS 2	168.126.63.2
VERSION	1.1.0.1

MAC ADDRESS	Displays default MAC ADDRESS of equipment
DHCP	Displays DHCP setting
IP ADDRESS	Displays IP address
GATEWAY	Displays GATEWAY address
NETMASK	Displays NETMASK address
DNS1,2	Displays DNS address
VERSION	Displays Software Version

※ DHCP setting : Please refer to section of web setting '2. network setting'.

## 13. USB PLAYBACK BUTTONS

## 1) USB input port

Insert a USB memory stick into the USB port.



※ It may cause a problem ejecting a memory stick while music file in USB is playing.

## 2) ■ Stop button

## 3) ▶▶ / || playback / pause button

## 4) ◀◀, ▶▶ previous / next button

Moves to previous or next song by pressing the button and moves to previous or next folder by pressing the button for more than 2 second.

## 5) MODE button

Sets the play mode by pressing the button in regular sequence.

All song repeat → all song random play → all song randomly repeat → single song play → single song repeat → folder play → folder random play → folder random repeat → All song repeat.

## 14. AUX INPUT

3.5mm Tip Ring Sleeve (TRS) jack on the front panel.

## Rear Panel

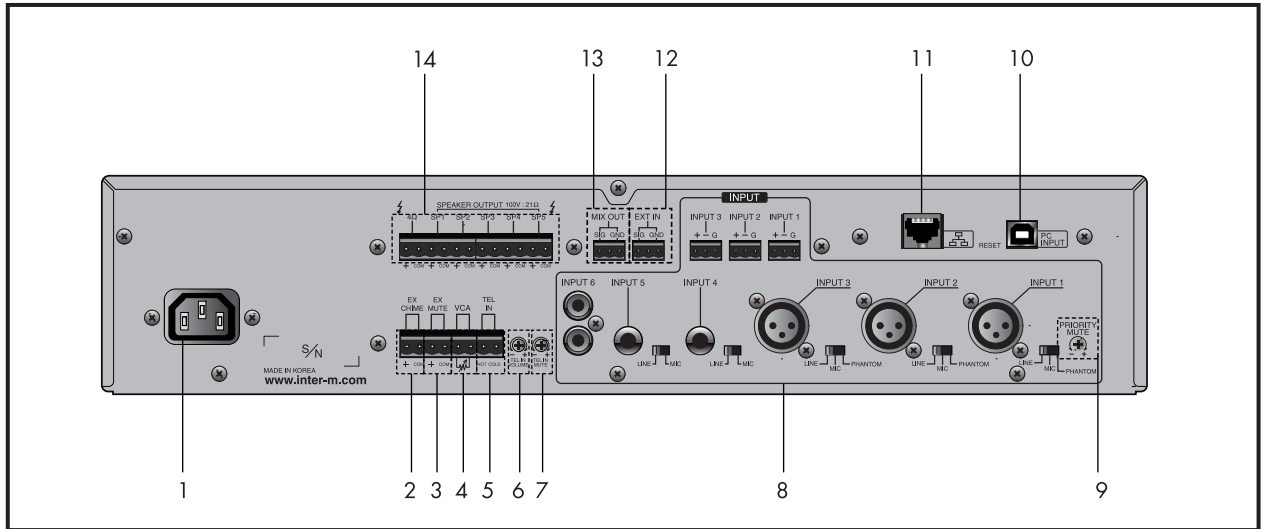

### 1. AC MAINS (AC INLET)

It accepts a standard IEC mains cable, provided.

### 2. REMOTE CHIME SWITCH TERMINAL

This terminal is used to activate the 4 tone chimes remotely.

### 3. MANUAL MUTE TERMINAL

When these two terminals are shorted, the output signal is blocked and the protection indicator on the front panel flashes.

### 4. VCA (VOLTAGE CONTROLLED AMPLIFIER) TERMINAL

These two terminals provide connection for an external potentiometer. When the potentiometer is connected, it allows for remote control of the master volume level.

Note that individual input volume control positions limit the maximum output level adjustable with the remote volume control.

※ Make sure not to set the main volume control to minimum level.

- Connection of remote volume control

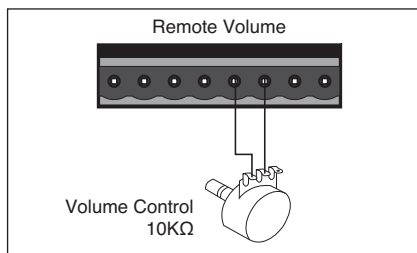

※Note : Negative terminal should not be grounded. Never connect it to the unit's chassis or other circuit ground.

**5. TEL IN TERMINAL**

This terminal is provided for connection with a telephone exchange system for paging purposes.

※NOTE : When the telephone input is active, all other input signal except AMP IN are muted.

**6. TEL IN VOLUME CONTROL**

It controls the volume of the TEL IN.

**7. TEL IN PRIORITY VOLUME CONTROL**

It controls the mute level of all other input signal when the TEL IN signal is present

**8. INPUT 1~6**

INPUT 1~6 are utilized to connect various external sound source devices including MIC, CD, TUNER, and other.

1) INPUT 1~3 are provided on balanced XLR JACKs and EURO Terminals Each input have a 3 position level and phantom power selector switch.

- LINE: used for LINE level signal input.

- MIC: used for the MIC level signal input such as dynamic mics.

- PHANTOM: used to power condenser type mics with DC 24V.

※NOTE : Because INPUT 1~3 XLR Jacks are in parallel with the Euro terminal, do not use them simultaneously.

2) INPUT 4~5 are provided on balanced TRS 1/2 inch JACKs. Each input has a 2 position level selector switch.

- LINE: used for LINE level signal input.

- MIC: used for the MIC level signal input such as dynamic mics.

3) INPUT 6 is provided on stereo summing RCA JACKs.

**9. PRIORITY VOLUME CONTROL**

It controls the priority control volume when the signal is inputted to the INPUT 1~2, EXT IN, CHIME and SIREN.

※ The signal from INPUT 1~2, EXT IN, CHIME input has priority over all other input signal and BGM broadcasting.

**10. PC USB STREAM CONNECTION TERMINAL**

This is a USB sound card that connects to PC with WINDOWS 7 operating system, It automatically detects and play USB sound from PC.

**11. NETWORK CONNECTION TERMINAL**

This is an RJ45 network terminal. It connects the amplifier to the internet using an Ethernet switch, router or PC. The network port supports 10/100Mbps and Auto MDIX.

**12. EXT IN**

This line-level input connects an external mixer to the amplifier expanding input channels.

**13. MIX OUT**

This line-level output connects the amplifier to an external processing unit or recorder.

**14. SPEAKER OUTPUT TERMINAL**

PMU-60N	15.5V/4Ω	100V/167Ω	70V/83Ω
PMU-120N	22V/4Ω	100V/83Ω	70V/42Ω
PMU-240N	31V/4Ω	100V/42Ω	70V/21Ω

※ Please note that SP 1~5 terminal will be controlled by speaker selector switch of front panel.

## Web Setting

- ※ Contents of this Operation Manual are subjected to be changed by revision of firmware. please refer to "www.inter-m.com/en" for latest one.

### I. Accessing PMU-N Series Web-page

- If IP address has not been set, type the default IP address (192.168.1.99)
  - by pushing the factory set switch more than 5 second, the unit will be reset as default mode.

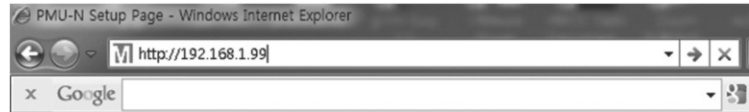

When connected normally, user verification window will pop-up.



Type the created ID and PASSWORD to log in. (Default ID: admin, Password: 1)

- ※ Changing password: please refer to the section of '11. password setting'
- ※ Caution : It is better to set and use the assigned password for the security purpose.  
Please make a note to keep the assigned password.

### II. Network Setup

interM PMU-N Series  
Language : English  
admin (logout) / pmu-n / swinterm.dyndns.org / Version : 1,1,0,1

Setup network configurations

MAC address	00:00:00:00:00:0D	
Host name	pmu-n	
IP address	<input type="radio"/> Dynamic IP assignment from DHCP Server <input checked="" type="radio"/> Manual Setting	
	IP address	192.168.1.99
	Subnet Mask	255.255.255.0
	Gateway	192.168.1.1
	DNS 1 Server	168.126.63.1
	DNS 2 Server	168.126.63.2

Apply Initialize

\* Help&Tips

- It configures the way for system to connect to Internet.
- If the IP Address changes Please access the web page again.
- Space cannot be included in the host name.
- The character of the host name must be an alphabet or a digit!

Copyright (c) 2012 Inter-M All rights reserved.

This is network setting page. The host name is used for each of identification when multiple unit is in auto searching mode.

- ※ IP address : Network information automatically set by DHCP (Dynamic Host Configuration Protocol) or can be set as Static IP address.

By pressing select button briefly DHCP setting screen will be shown as below, select YES or NO to complete.

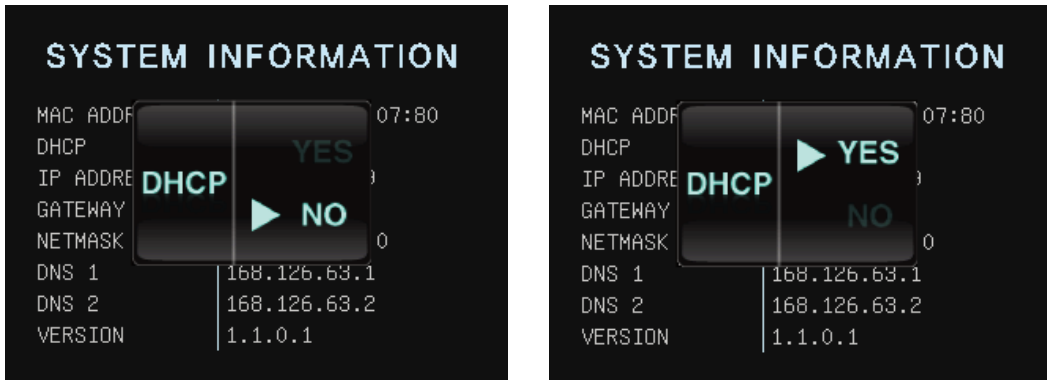

After setting the network by DHCP, it must be reconnected with a changed IP.  
 If the network is set as Static IP address, it will be connected automatically with a changed IP.

※ Caution : After changing the IP address or network setting , the reconnection must be applied with a reconfigured IP.

### III. Operation Mode Setup

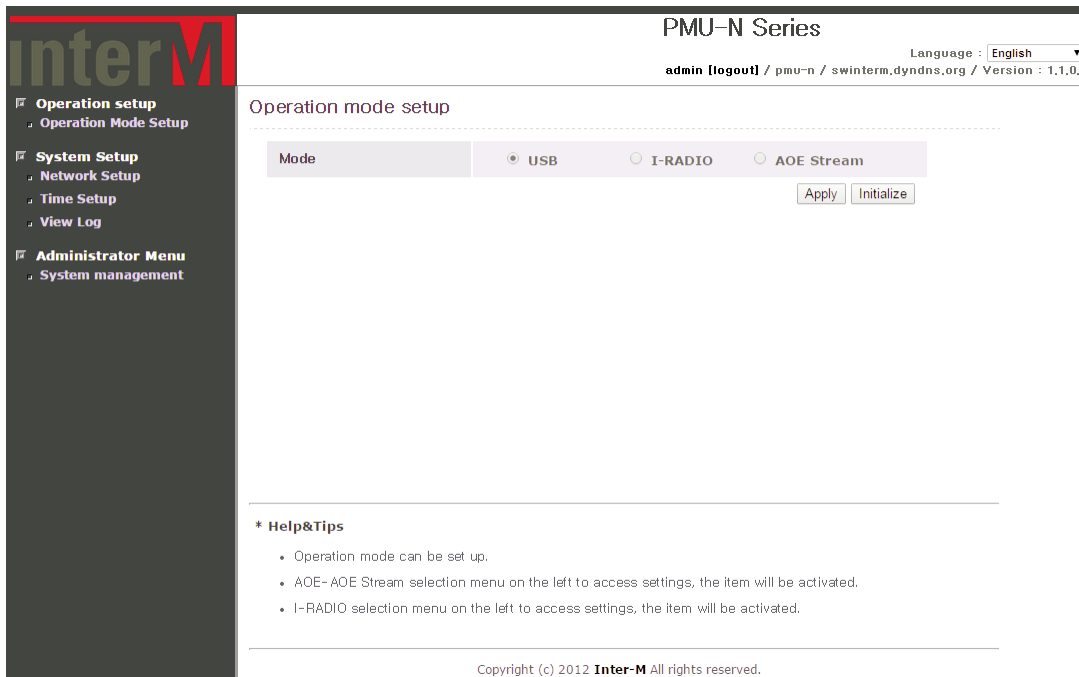

The PMU-N can be set to operate in one of 3 source modes, USB player. Internet radio or AOE stream this configuration page allows you to select the source mode.



## IV. I-Radio Setup

Select the station from Channel title and click Play button to receive the broadcast. Please note that during play and stop operation, it may take some time and might hear unwanted sounds. For channel editing functions please refer to the following pages. Click Edit button to display a pop-up window as shown in the following pages.

Title	URL	Remove
MBC standard FM	mms://VODSTR.cjmbc.co.kr/STFM	Remove
MBC FM4U	mms://222.113.53.4/chmbcfm	Remove
MBC AM	mms://222.113.53.4/chmbcam	Remove
SBS PowerFM	mms://211.224.129.155/kbc_fm	Remove
CBS STANDARD FM	mms://widget.cbs.co.kr/cbs981_live	Remove
CBS MUSIC FM	mms://widget.cbs.co.kr/cbs939_live	Remove
YTN FM 94.5MHz	http://live.ytnradio.kr:8000	Remove
KUKDONG BROADCASTING	mms://live.febc.or.kr/livefm	Remove
BUDDHISM BROADCASTING	mms://218.146.253.176/bbsradiolive	Remove
PYUNGHWA BROADCASTING	mms://61.106.58.10:1088	Remove
WQXR: New York's Classical	http://wnyc-wqxr-ice.streamguys.com/80/	Remove
Part of Classical 105.9 WQXR	http://wqxr-q2.streamguys.com/q2	Remove
WUWF Public Radio Classic	http://pubint.ic.lnwd.net/stream/pubint_wu	Remove
WMFE Public Broadcasting St	http://live.str3am.com:2030	Remove
KALW 91.7 SAN FRANCISCO	http://live.str3am.com:2430	Remove
Classic FM 100.9MHz	http://media-ice.musicradio.com/ClassicF	Remove
BBC Radio3 91.3	mms://wm-live.bbc.net.uk/wms/bbc_ami/r	Remove
the pulse 102.5FM	http://stream5.radiomonitor.com/Pulse	Remove
BBC Radio 4 (BBC R4) - 93.5M	mms://wm-live.bbc.net.uk/wms/bbc_ami/r	Remove
BBC Radio 5 live (BBC R5L) - 9	mms://wm-live.bbc.net.uk/wms/bbc_ami/r	Remove

Modify or delete the station title and address directly or enter the title and address at the bottom (Title/URL) to add to the broadcast list. Click Apply button to apply the changed settings to the device. Click Export button to save the stored channel list file. Before modifying the content, can create back up using export function and click Import button to apply the saved channel list to other devices.

## V. AOE-Connection Setup

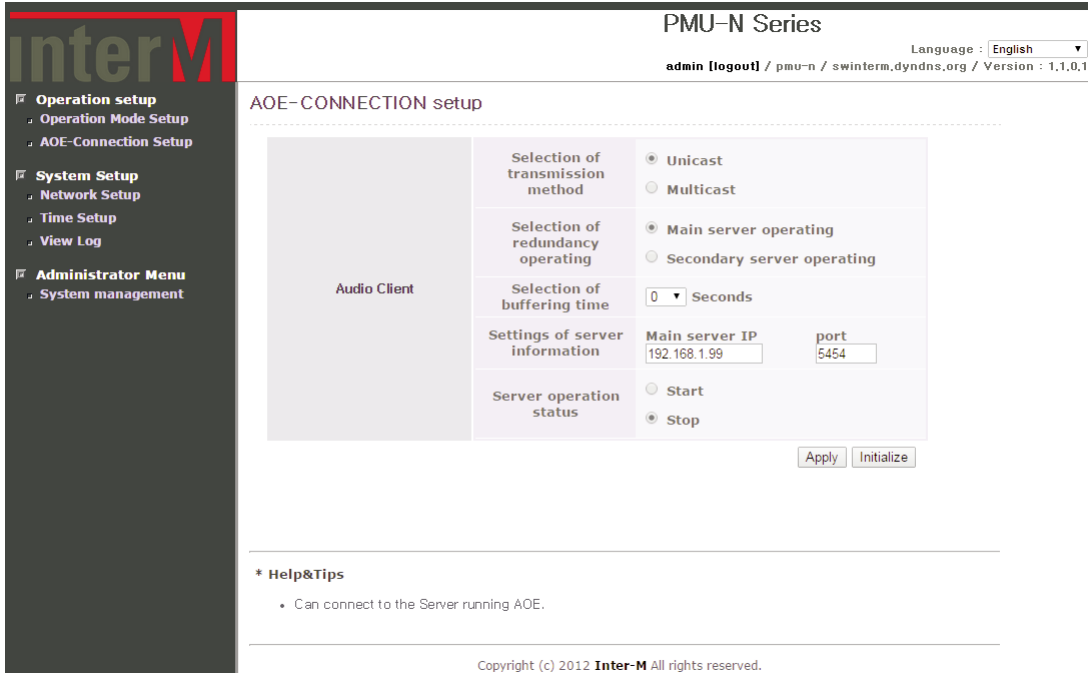

PMU-N Series

Language : English

admin [logout] / pmu-n / swinterm.dyndns.org / Version : 1.1.0.1

### AOE-CONNECTION setup

Audio Client	Selection of transmission method	<input checked="" type="radio"/> Unicast <input type="radio"/> Multicast	
	Selection of redundancy operating	<input checked="" type="radio"/> Main server operating <input type="radio"/> Secondary server operating	
	Selection of buffering time	0 Seconds	
	Settings of server information	Main server IP 192.168.1.99	port 5454
	Server operation status	<input type="radio"/> Start <input checked="" type="radio"/> Stop	
			<input type="button" value="Apply"/> <input type="button" value="Initialize"/>

\* Help&Tips

- Can connect to the Server running AOE.

Copyright (c) 2012 Inter-M All rights reserved.

AOE-212N is Network Audio Stream Server/Client equipment developed by Inter-M. It can be built a broadcasting system over the internet network which makes a possible to build a broadcasting system without a distance limitation.

PMU-N series can broadcast audio streaming from AOE-212N over the network.

Select the identical operation mode of connected AOE-212N and configure the server IP address and port.

Mode : It must be selected as same mode of AOE-212N (stream server) for normal operation.

Select redundant operation: Select secondary server to configure the redundancy of the streaming server.

Server Information Set – Main Server IP : Set the IP address of AOE-212N which is communicated with PMU-N.

Server Information Set - Port : Use the same port of AOE-212N

Buffering Time : The initial value is set to 0 seconds. A smaller value reduces the wait time or latency, whereas the larger the value the longer is the wait time or latency. The maximum value is 10 seconds. A higher buffer ratio will increase the stream stability and reduce dropouts usually related to network traffic.

Server Operating Status: Select <Start> to connect the AOE-212N and begin streaming and select <stop> to end streaming.

※ Caution : If AOE-212N is set with DHCP, the IP address may be changed when AOE-212N is turned on after power was turned off. When PMU-N is not connected with AOE-212N, make sure to check the correct IP address of AOE-212N.

## VI. Time Setup

The screenshot shows the 'Time and Date Setup' page in the PMU-N Series web interface. The page is titled 'Time and Date Setup' and includes a sidebar menu on the left with categories like 'Operation setup', 'System Setup', and 'Administrator Menu'. The main content area displays the current time zone as '(GMT+09:00) Seoul' and the current time as '20.10.2013 / 14:58:04'. There are two options for time setup: 'Manual Setup' with input fields for year (2013), month (10), day (20), hour (14), minute (58), and second (04); and 'Automatic time synchronization' with a server address field set to 'time.bora.net'. An 'Apply' button is located at the bottom right of the form. Below the form, there is a 'Help&Tips' section with two bullet points explaining potential time differences and the requirement for internet connectivity. The footer contains the copyright notice: 'Copyright (c) 2012 Inter-M All rights reserved.'

The menu for setting a time and date of equipment.

It can be set to Time zone and current time and the current time can be set manually or automatically.

User can set the years from 1970 to 2037 period.

When the current time is set as automatic time synchronization, the server address must be typed (default: time.bora.net) and unit must be connected with internet.

## VII. View Log

The screenshot shows the web interface for the PMU-N Series. The top right corner displays 'PMU-N Series', 'Language : English', and user information 'admin [logout] / pmu-n / swinterm.dyndns.org / Version : 1.1.0.1'. The left sidebar contains a navigation menu with the following items:

- Operation setup
  - Operation Mode Setup
- System Setup
  - Network Setup
  - Time Setup
  - View Log
- Administrator Menu
  - System management

The main content area is titled 'View log file' and contains a large empty box for log data. Below the box are buttons for 'Refresh' and 'Clear Log'. A 'Download the log' button is located in the top right corner of the log area. At the bottom, there is a 'Help&Tips' section with a note about clearing the log:

\* **Help&Tips**

- You may clear all log by clicking 'Clear Log' button.

Copyright (c) 2012 **Inter-M** All rights reserved.

It displays the log information of unit setting and history of modification with time. If time has not been set, the log information will be shown with jan/ 1/ 1970 as default.

Download Log : this allows you to download the log file to your PC (for debugging purpose)

Refresh : identify the recent changed log info

Clear Log : clear the history of log info

## VIII. System Management

The screenshot shows the web interface for the PMU-N Series. The top right corner displays 'PMU-N Series', 'Language : English', and 'admin [logout] / pmu-n / swinterm.dyndns.org / Version : 1.1.0.1'. The left sidebar menu includes 'Operation setup', 'System Setup', and 'Administrator Menu', with 'System management' selected. The main content area is titled 'System management' and contains four sections:

- System Upgrade:** Includes a 'Find File' section with a text input field and a '...' button. Below it are 'Apply' and 'Initialize' buttons. Text: 'Firmware file is an upgrade-file that is located in your local PC. It may several minutes to complete upgrading. Please do not leave this page until a new page appears. (Caution) Upgrading with inappropriate file may cause harm to the system. (Caution) Do not turn off the system during upgrading.'
- Password Change:** Includes a 'User account' dropdown menu set to 'admin', and three password input fields: 'Current Password', 'New Password', and 'Password Confirm'. Below are 'Apply' and 'Initialize' buttons. Text: 'Change the new password. 32 letters and numbers you entered.'
- Restart System:** Includes an 'Apply' button. Text: 'Restart will reboot the system.'
- Factory set System:** Includes an 'Apply' button. Text: 'Factory set will Initialization the device.'

- System Upgrade  
After downloading the upgrade, file to your PC, press  button to select the file from your PC then press APPLY to start the upgrading process. When the upgrade is completed, the PMU-N will reboot. This process takes about a one minute. The network settings are maintained.
- Password Change  
By selecting Password change in the menu, the password change page will display. For better security it is recommended to change the password. If the Password is lost or forgotten, reset the device to return to factory default settings. The default password is "1".  
(Only the the password can be changed. The ID – is fixed to <admin> and cannot be changed.
- Restart System  
This will reboot (or restart) the device. The process will take about one minute.
- Factory Set System  
All settings including Network configuration, including user programmable channels and operation mode will be set to default factory settings. This process will take about one minute to complete.

## Speaker Connection

Before connecting speakers to the unit, be sure to disconnect the AC power cable.  
Make certain that the total impedance is not less than the rated impedance indicated.

- 4Ω Impedance

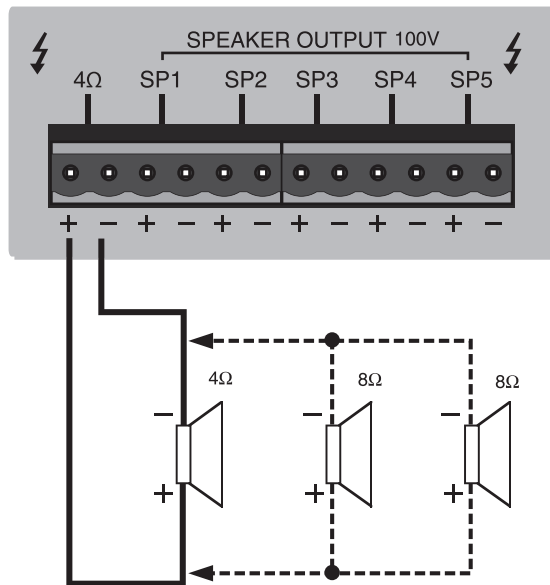

- High Impedance

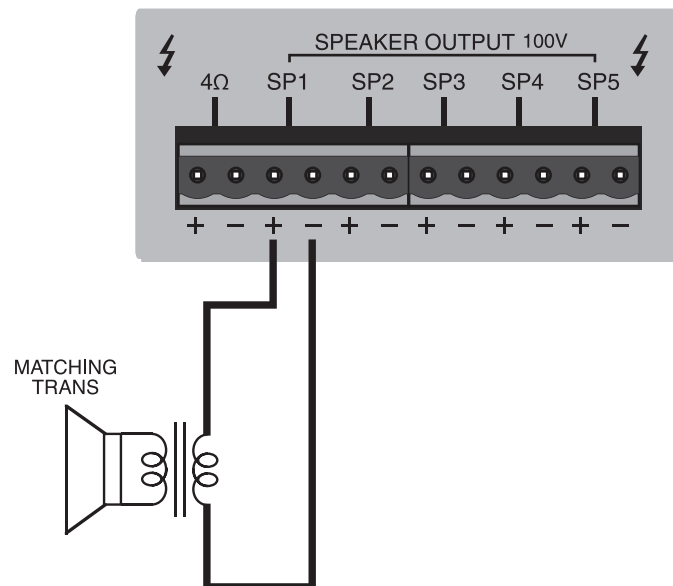

※ Warning : For high impedance systems, connect with matching transformer as the following Figure. Be certain that the total impedance does not equal less than the rated impedance.

	Low Impedance	(100V)	(70V)
PMU-60N	4Ω	167Ω	83Ω
PMU-120N	4Ω	83Ω	42Ω
PMU-240N	4Ω	42Ω	21Ω

Please do not use a 4Ω and SP1~SP5 terminal at the same time.

# System Connection

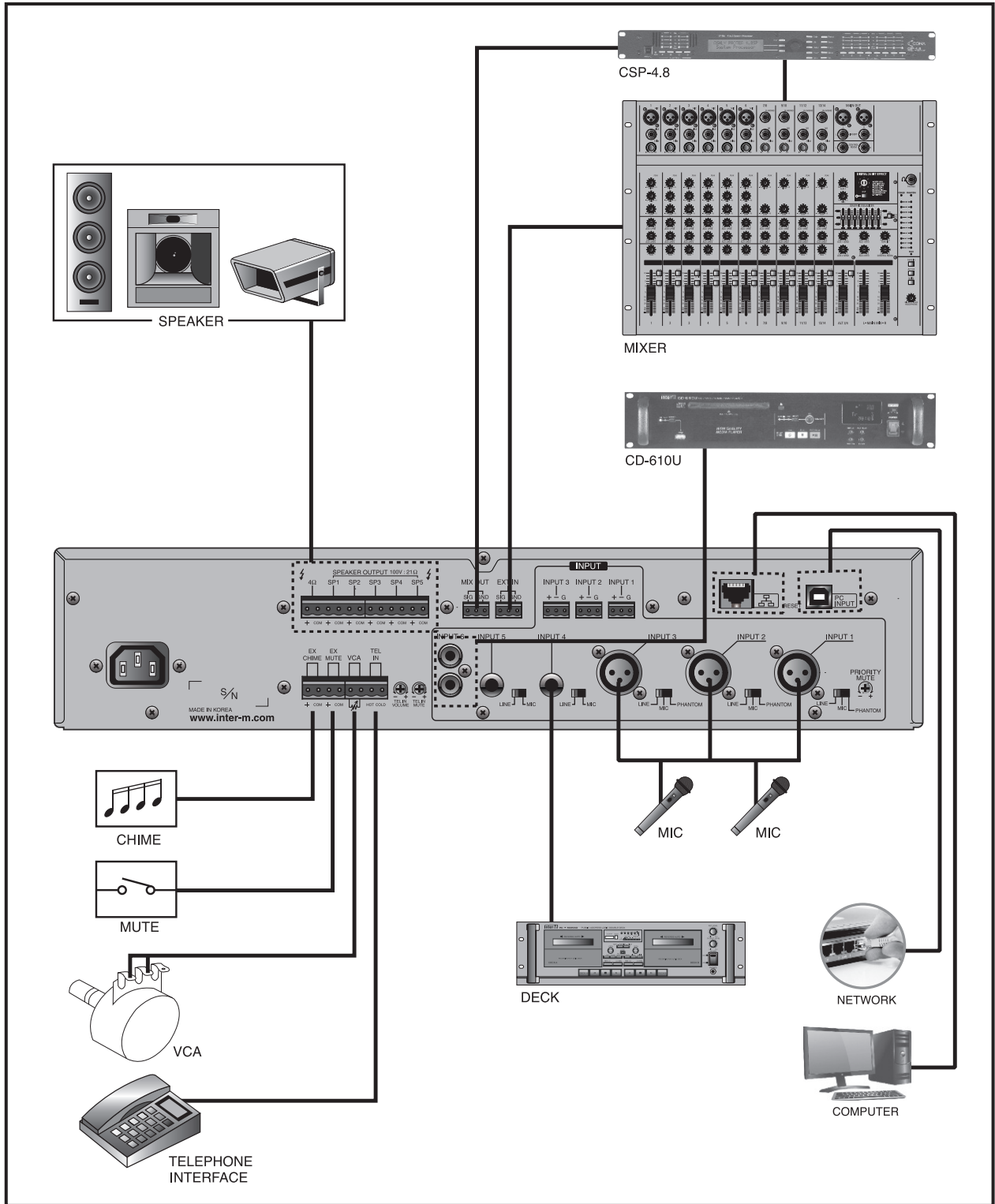



# Block Diagram

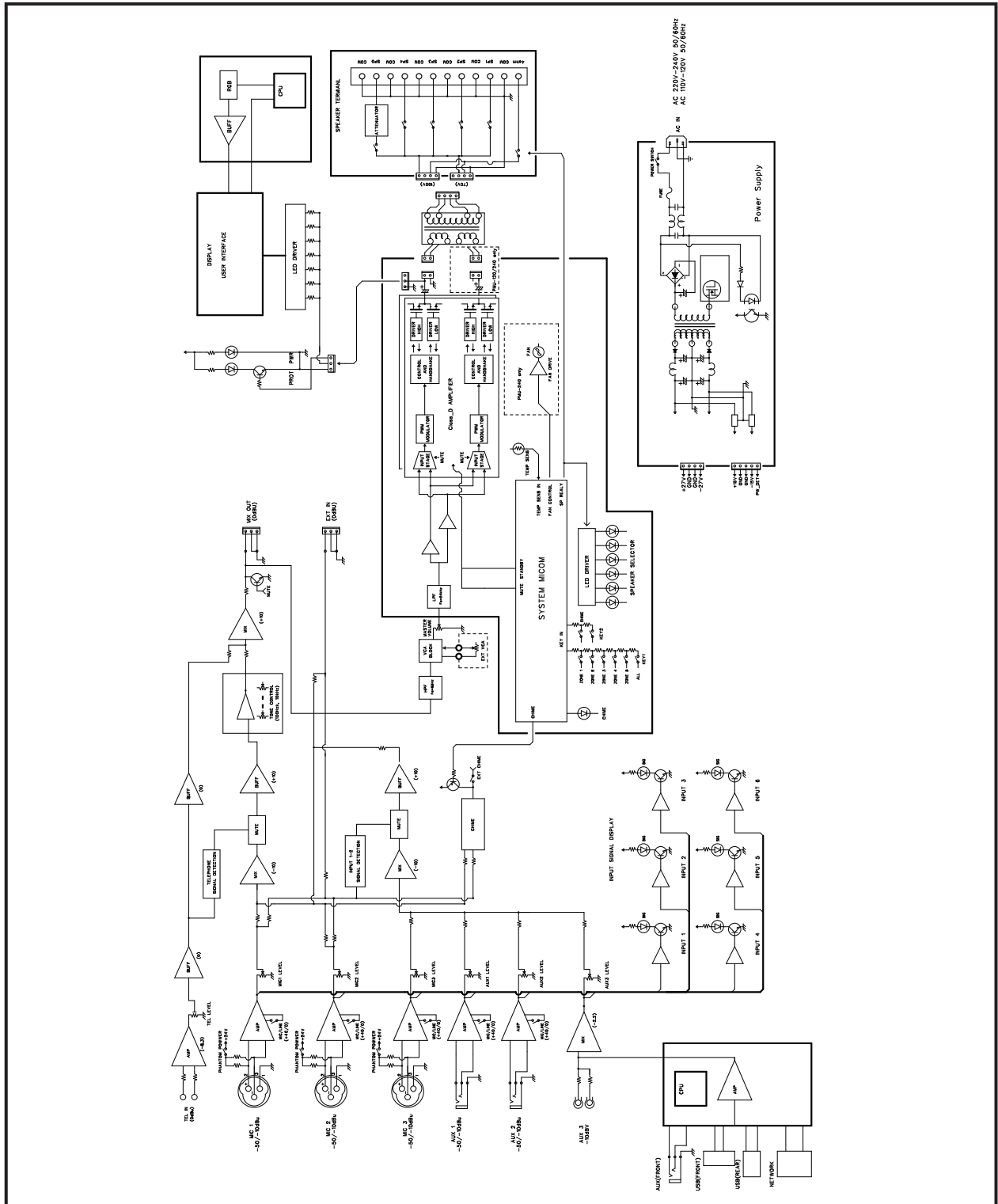

## Specifications

			PMU-60N	PMU-120N	PMU-240N
Rated Output Power			60W	120W	240W
Frequency Response (SP OUT/1W output)			80Hz~15kHz		
T.H.D (Rated Output, 1kHz)			Less than 0.5%		
S/N (Rated Output)			More than 78dB		
Tone Control (100Hz, 10kHz)			±10dB		
Input Sensitivity/ Impedance	Input 1~5	MIC	-50dBu/2kΩ		
		LINE	-10dBu/2kΩ		
	Input 6		-10dBu/10kΩ		
	TEL IN		0dBu/10kΩ		
	EXT IN		0dBu/20kΩ		
	MIX Out/Impedance		0dBu/10kΩ		
Speaker Output Level/Impedance	LOW-Z	15.5V/4Ω	22V/4Ω	31V/4Ω	
	HIGH-Z	100V/167Ω 70V/83Ω	100V/83Ω 70V/42Ω	100V/42Ω 70V/21Ω	
Operation Temperature			-10°C ~ +40°C		
Power Source			100-120VAC or 220-240VAC; 50/60Hz (Supplied AC mains transformer depends on country requirements)		
Power Consumption (1/8W output)			50W		75W
Weight (SET)			5.4kg/11.9lb	6.7kg/14.8lb	8.0kg/17.6lb
Dimensions (SET)			420(W)x88(H)x319(D)mm/16.5(W)x3.5(H)x12.6(D)in		

\* Design and specification are subject to be changed for the improvement of product quality without pre notice.

※ DIMENSIONS

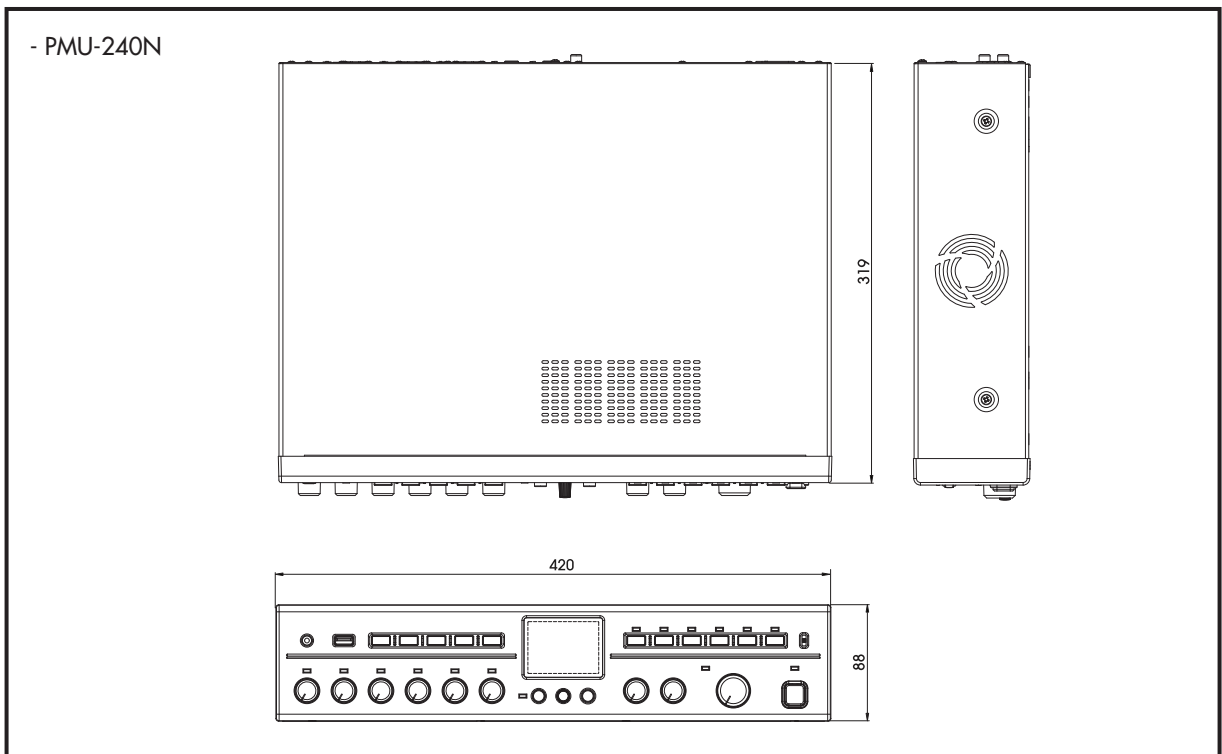
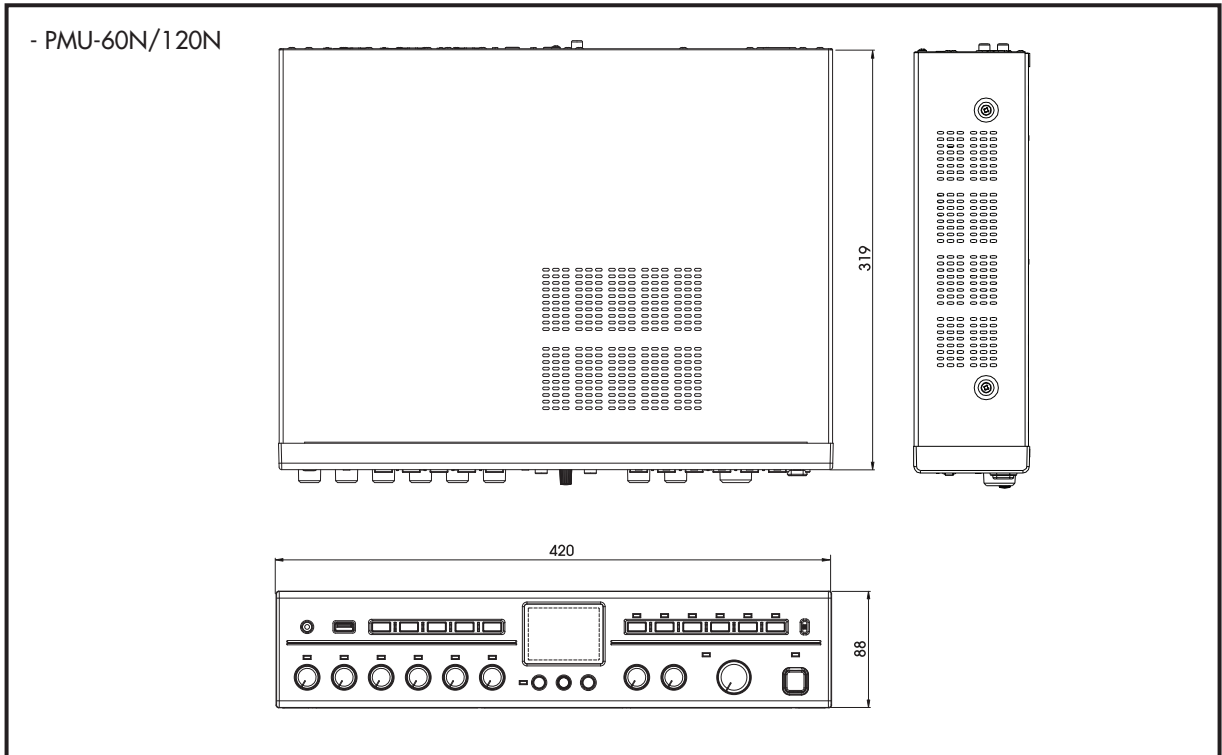

## Service

### Procedures

Take steps to insure the problem is not related to operator error or other products within the system. Information provided in the troubleshooting portion of this manual may help with this process. Once it is certain that the problem is related to the product contact your warranty provider as described in the warranty section of this manual.

### Schematic

A Schematic is available by contacting your warranty provider.

### Parts List

A Parts List is available by contacting your warranty provider.

## Variations and Options

### Variations

Products supplied through legitimate sources are compatible with local AC power requirements.

### Options

No optional items are available for this product.

## Warranty

Warranty terms and conditions vary by country and may not be the same for all products. Terms and conditions of warranty for a given product may be determined first by locating the appropriate country which the product was purchased in, then by locating the product type.

To obtain specific warranty information and available service locations contact Inter-M directly or the authorized Inter-M Distributor for your specific country or region.







# interM



Inter-M, Ltd. (Korea) began operations in 1983.

Since then, Inter-M has grown to become one of the largest manufacturers of professional audio and commercial sound electronics equipment in the world.

Inter-M has gained worldwide recognition for its own branded products, as well as private label manufacturing of electronics sold under other names (OEM).

The company is no longer just a Korean company, but rather a global company that is truly international in scope, with factories and offices in Korea and China, and sales and marketing operations located in Japan, Europe, and the U.S.A.

With more than 850 employees around the globe, Inter-M is well-poised for further growth and expansion.

**Inter-M Americas, INC.**

13875 ARTESIA BLVD. CERRITOS, CA 90703 USA  
TEL : +1-562-921-0313, FAX : +1-562-921-0370  
Home Page : <http://www.inter-m.net>, E-mail : [info@inter-m.net](mailto:info@inter-m.net)

**Inter-M Corporation**

SEOUL OFFICE : 719, DOBONG-RO, DOBONG-GU, SEOUL, KOREA  
TEL : +82-2-2289-8140~8, FAX : +82-2-2289-8149  
Home Page : <http://www.inter-m.com>, E-mail : [overseas@inter-m.com](mailto:overseas@inter-m.com)

**MADE IN KOREA**  
November 2015 136954