



fungeneration

PicoBeam 30
Quad LED
moving head

Musikhaus Thomann
Thomann GmbH
Hans-Thomann-Straße 1
96138 Burgebrach
Deutschland
Telephone: +49 (0) 9546 9223-0
E-mail: info@thomann.de
Internet: www.thomann.de

26.01.2017, ID: 372682

Table of contents

1	General information	5
	1.1 Further information.....	6
	1.2 Notational conventions.....	7
	1.3 Symbols and signal words.....	8
2	Safety instructions	11
3	Features	16
4	Installation	17
5	Starting up	21
6	Connections and operating elements	23
7	Operating	26
	7.1 Starting the device.....	26
	7.2 Function selection.....	27
	7.2.1 DMX menu.....	28
	7.2.2 Scene menu.....	31
	7.2.3 Programme menu.....	35

7.3	Settings menu.....	36
7.4	Functions in 3-channel DMX mode (8-bit).....	43
7.5	Functions in 8-channel DMX mode (16-bit).....	43
7.6	Functions in 13-channel DMX mode (16-bit).....	46
8	Remote control.....	49
9	Technical specifications.....	52
10	Plug and connection assignments.....	53
11	Troubleshooting.....	54
12	Cleaning.....	56
13	Protecting the environment.....	57

1 General information

This manual contains important instructions for the safe operation of the unit. Read and follow the safety instructions and all other instructions. Keep the manual for future reference. Make sure that it is available to all those using the device. If you sell the unit please make sure that the buyer also receives this manual.

Our products are subject to a process of continuous development. Thus, they are subject to change.

1.1 Further information

On our website (www.thomann.de) you will find lots of further information and details on the following points:

Download	This manual is also available as PDF file for you to download.
Keyword search	Use the search function in the electronic version to find the topics of interest for you quickly.
Online guides	Our online guides provide detailed information on technical basics and terms.
Personal consultation	For personal consultation please contact our technical hotline.
Service	If you have any problems with the device the customer service will gladly assist you.

1.2 Notational conventions

This manual uses the following notational conventions:

Letterings

The letterings for connectors and controls are marked by square brackets and italics.

Examples: *[VOLUME]* control, *[Mono]* button.

Displays

Texts and values displayed on the device are marked by quotation marks and italics.

Examples: *'24ch'*, *'OFF'*.

Text input

Text inputs that are carried out on the device are indicated by typewriter font.

Example: 2323

Cross-references



References to other locations in this manual are identified by an arrow and the specified page number. In the electronic version of the manual, you can click the cross-reference to jump to the specified location.

Example: See  'Cross-references' on page 7.

1.3 Symbols and signal words

In this section you will find an overview of the meaning of symbols and signal words that are used in this manual.

Signal word	Meaning
DANGER!	This combination of symbol and signal word indicates an immediate dangerous situation that will result in death or serious injury if it is not avoided.
WARNING!	This combination of symbol and signal word indicates a possible dangerous situation that can result in death or serious injury if it is not avoided.
CAUTION!	This combination of symbol and signal word indicates a possible dangerous situation that can result in minor injury if it is not avoided.
NOTICE!	This combination of symbol and signal word indicates a possible dangerous situation that can result in material and environmental damage if it is not avoided.
Warning signs	Type of danger
	Warning – high-voltage.

Warning signs	Type of danger
 A yellow triangular warning sign with a black border, depicting a crane hook lifting a rectangular load.	Warning – suspended load.
 A yellow triangular warning sign with a black border, featuring a large black exclamation mark.	Warning – danger zone.

2 Safety instructions

Intended use

This device is intended to be used as moving-head spotlight. The device is designed for professional use and is not suitable for use in households. Use the device only as described in this user manual. Any other use or use under other operating conditions is considered to be improper and may result in personal injury or property damage. No liability will be assumed for damages resulting from improper use.

This device may be used only by persons with sufficient physical, sensorial, and intellectual abilities and having corresponding knowledge and experience. Other persons may use this device only if they are supervised or instructed by a person who is responsible for their safety.

Safety



DANGER!

Danger for children

Ensure that plastic bags, packaging, etc. are disposed of properly and are not within reach of babies and young children. Choking hazard!

Ensure that children do not detach any small parts (e.g. knobs or the like) from the unit. They could swallow the pieces and choke!

Never let children unattended use electrical devices.



DANGER!

Electric shock caused by high voltages inside

Within the device there are areas where high voltages may be present. Never remove any covers.

There are no user-serviceable parts inside.



DANGER!

Electric shock caused by short-circuit

Always use proper ready-made insulated mains cabling (power cord) with a protective contact plug. Do not modify the mains cable or the plug. Failure to do so could result in electric shock/death or fire. If in doubt, seek advice from a registered electrician.



WARNING!

Eye damage caused by high light intensity

Never look directly into the light source.



WARNING!

Risk of epileptic shock

Strobe lighting can trigger seizures in photosensitive epilepsy. Sensitive persons should avoid looking at strobe lights.



CAUTION!

Risk of injury due to movements of the device

The head of the device can move quickly (pan, tilt) and can produce very bright light. This is also valid immediately after you turn on the device, when the device operates in automatic mode or under remote control and when you turn off a DMX controller that is connected to the device. Persons staying near the device could be injured or frightened.

Before you turn on the device and during the operation, always ensure that nobody stays close to the device. If work has to be performed in the area of movement or in the near vicinity of the device, it must remain turned off.



NOTICE!

Risk of fire

Do not cover the device nor any ventilation slots. Do not place the device near any direct heat source. Keep the device away from naked flames.



NOTICE!

Operating conditions

This device has been designed for indoor use only. To prevent damage, never expose the device to any liquid or moisture. Avoid direct sunlight, heavy dirt, and strong vibrations.



NOTICE!

Power supply

Before connecting the device, ensure that the input voltage (AC outlet) matches the voltage rating of the device and that the AC outlet is protected by a residual current circuit breaker. Failure to do so could result in damage to the device and possibly injure the user.

Unplug the device before electrical storms occur and when it is unused for long periods of time to reduce the risk of electric shock or fire.

3 Features

The moving head is particularly suitable for professional lighting tasks, for example at events, on rock stages, in theatres and musicals, in nightclubs as well as for mobile DJ's and entertainer.

Special features of the device:

- Two movable axes with 8 or 16 bit resolution:
 - Tilt (230°)
 - Pan (540°)
- Pan and Tilt invertible
- 1 × 30 W High Performance RGBW QuadColour LED
- RGBW colour mixing
- Very narrow beam angle of only 4°
- Control via DMX (3, 8 or 13 channels) and via buttons and display on the unit
- Automatic mode with 4 preprogrammed shows
- Sound-to-Light with 4 built-in shows
- Electronic dimmer 0 to 100%
- Shutter frequency 0...20 Hz
- Omega bracket and infrared remote control included

4 Installation

Unpack and carefully check that there is no transportation damage before using the unit. Keep the equipment packaging. To fully protect the device against vibration, dust and moisture during transportation or storage use the original packaging or your own packaging material suitable for transport or storage, respectively.



WARNING!

Risk of injury by falling off

Make sure that the installation complies with the standards and rules that apply in your country. Always secure the device with a secondary safety attachment, such as a safety cable or a safety chain.

The carrying capacity of the truss or other mounting must be sufficient for the intended number of devices. Note that the movement of the head may additionally stress the load-bearing structures.



CAUTION!

Risk of injury due to movements of the device

The head of the device can move quickly (pan, tilt) and can produce very bright light. This is also valid immediately after you turn on the device, when the device operates in automatic mode or under remote control and when you turn off a DMX controller that is connected to the device. Persons staying near the device could be injured or frightened.

Before you turn on the device and during the operation, always ensure that nobody stays close to the device. If work has to be performed in the area of movement or in the near vicinity of the device, it must remain turned off.



NOTICE!

Risk of overheating

Always ensure sufficient ventilation.

The ambient temperature must always be below 40 °C (104 °F).



NOTICE!

Possible damage caused by movements of the device

Always ensure that enough space is free around the device for the movements of the head (pan, tilt).



NOTICE!

Possible data transmission errors

For error-free operation make use of dedicated DMX cables and do not use ordinary microphone cables.

Never connect the DMX input or output to audio devices such as mixers or amplifiers.



Please note that this device must not be connected to a dimmer.

Mounting options

You can install the device on the wall, ceiling or floor.

The threads on the housing bottom are used to secure the supplied Omega bracket or truss clamps.

5 Starting up

Establish all connections as long as the unit is switched off. Use the shortest possible high-quality cables for all connections.

Connections in DMX mode

Connect the DMX input of the device to the DMX output of a DMX controller or another DMX device. Connect the output of the first DMX device to the input of the second one, and so on to form a daisy chain. Always ensure that the output of the last DMX device in the daisy chain is terminated with a resistor ($110\ \Omega$, $\frac{1}{4}\text{ W}$).

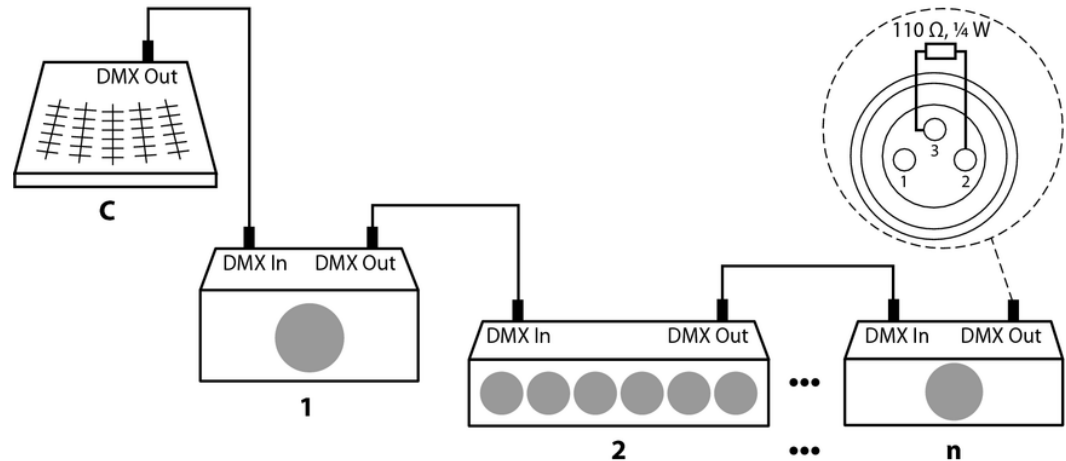

6 Connections and operating elements

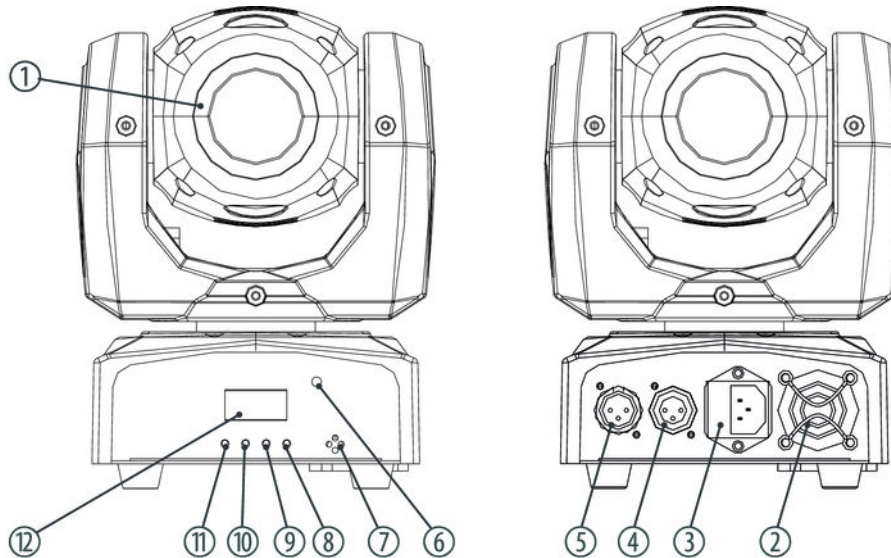

PicoBeam 30 Quad LED

1	Light aperture.
2	Fan.
3	IEC chassis plug for the mains cable with fuse holder.
4	<i>[DMX Out]</i> DMX output.
5	<i>[DMX In]</i> DMX input.
6	Infrared sensor for receiving remote control signals.
7	Microphone for sound control.
8	<i>[ENTER]</i> Calls up the menu for the respective operation mode, confirms a set value.
9	<i>[DOWN]</i> Decreases the displayed value by one and selects menu items.

10	<i>[UP]</i> Increases the displayed value by one and selects menu items.
11	<i>[MODE]</i> Calls up the settings menu, skips one menu level back and closes an opened submenu without saving any changes.
12	Display.

7 Operating

7.1 Starting the device



CAUTION!

Risk of injury due to movements of the device

The head of the device can move quickly (pan, tilt) and can produce very bright light. This is also valid immediately after you turn on the device, when the device operates in automatic mode or under remote control and when you turn off a DMX controller that is connected to the device. Persons staying near the device could be injured or frightened.

Before you turn on the device and during the operation, always ensure that nobody stays close to the device. If work has to be performed in the area of movement or in the near vicinity of the device, it must remain turned off.

Connect the device to the power supply to start operation. After a few seconds, the fans start to work, the head moves to the home positions for rotation (pan) and inclination (tilt). After a few more seconds, the display shows 'A001'. The device is now operational.

7.2 Function selection

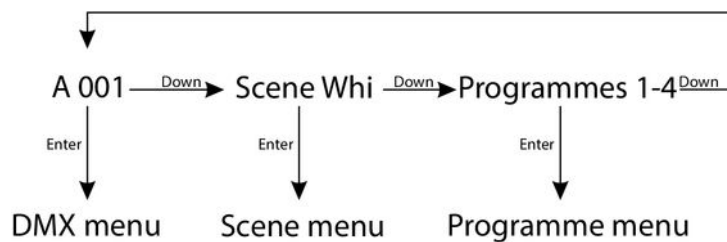

Press **[DOWN]** while 'A001' is flashing on the display to call up the preprogrammed scene.
Press **[DOWN]** repeatedly to call up any of the 4 programmes.

7.2.1 DMX menu

Press **[ENTER]** while 'A001' is flashing on the display to select the DMX menu. Press **[ENTER]** to call up the first menu item.

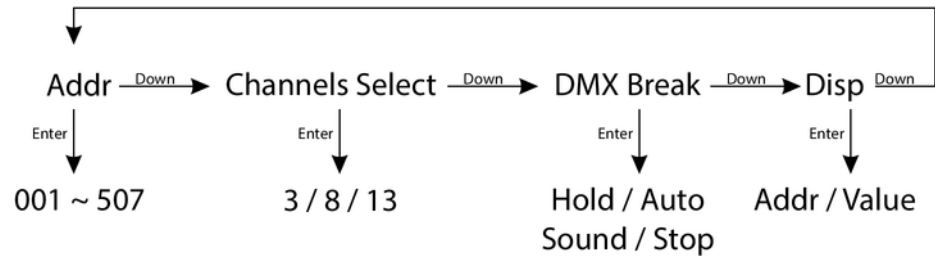

DMX address

The display shows 'Addr'. Press *[ENTER]* to then select the first DMX channel to be used by the device (DMX address) in a range from 001 to max. 510 by pressing *[UP]* and *[DOWN]*.

When the display shows the desired value press *[ENTER]* to save the setting and then *[DOWN]* to change to the next menu item. To change the menu item without making any changes, press *[MODE]*.

Make sure that this number matches the configuration of your DMX controller. The following table shows the highest possible DMX address for the various DMX modes

Mode	Highest possible DMX address
3 channels	510
8 channels	505
13 channels	499

Selecting the number of DMX channels

The display shows 'ChS'. Press *[ENTER]* to then select the number of DMX channels to be used by the device by pressing *[UP]* and *[DOWN]*. Control via 3, 8 or 13 channels is available.

When the display shows the desired value press *[ENTER]* to save the setting and then *[DOWN]* to change to the next menu item. To change the menu item without making any changes, press *[MODE]*.

DMX break

The display shows 'brk'. Press *[ENTER]* to then select one of the options for the behaviour of the device in case the DMX connection is interrupted by pressing *[UP]* and *[DOWN]*. Choose 'Hold' if you want the device in that case to maintain the state that corresponds to the last received DMX signal. Choose 'Hold' if you want the device in that case to perform an automatic run. Choose 'Sound' if you want the device in that case to perform a sound-controlled automatic run. Choose 'Sound' if you want the device in that case to return to its home position.

When the display shows the desired value press *[ENTER]* to save the setting and then *[DOWN]* to change to the next menu item. To change the menu item without making any changes, press *[MODE]*.

Display

The display shows 'dISP'. Press [ENTER] to then select whether you want the display to show the DMX address of the device ('Addr') or the DMX value for the current channel ('VALu') by pressing [UP] and [DOWN].

When the display shows the desired value press [ENTER] to save the setting and then [MODE] twice to return to the function selection. To change the menu item without making any changes, press [MODE].

7.2.2 Scene menu

Press [DOWN] while 'A001' is flashing on the display to call up the preprogrammed  scene. Press [ENTER] twice to open the Scene menu and to change scene parameters as desired.

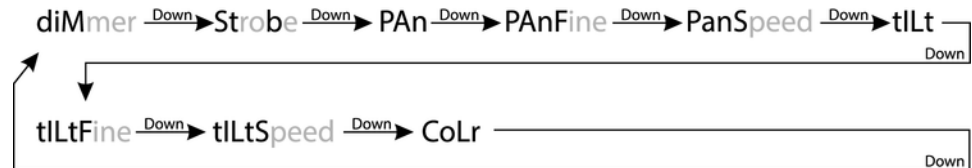

Dimmer

The display shows $\text{d} \mid \text{r}$. Press *[ENTER]* to then select a value between 000 and 255 for the intensity of the light effect by pressing *[UP]* and *[DOWN]*.

When the display shows the desired value press *[ENTER]* to save the settings. To change the menu item without making any changes, press *[MODE]*.

Strobe

Press *[DOWN]*. The display shows $\text{S} \mid \text{f}$. Press *[ENTER]* to then select a value between 010 and 255 for the strobe frequency of the light effect by pressing *[UP]* and *[DOWN]*. Values between 000 and 009 have no function here.

When the display shows the desired value press *[ENTER]* to save the settings. To change the menu item without making any changes, press *[MODE]*.

Rotation

Press *[DOWN]*. The display shows $\text{R} \mid \text{r}$. Press *[ENTER]* to then select a value between 000 and 255 for the head position on the axis of rotation by pressing *[UP]* and *[DOWN]*.

When the display shows the desired value press *[ENTER]* to save the settings. To change the menu item without making any changes, press *[MODE]*.

Fine tuning Rotation

Press *[DOWN]*. The display shows $\overline{P} \overline{P} \overline{r} \overline{r} \overline{F}$. Press *[ENTER]* to then select a value between 000 and 255 to fine tune the head position on the axis of rotation by pressing *[UP]* and *[DOWN]*.

When the display shows the desired value press *[ENTER]* to save the settings. To change the menu item without making any changes, press *[MODE]*.

Rotation speed

Press *[DOWN]*. The display shows $\overline{P} \overline{P} \overline{r} \overline{r} \overline{S}$. Press *[ENTER]* to then select a value between 000 and 255 for the rotation speed by pressing *[UP]* and *[DOWN]*.

When the display shows the desired value press *[ENTER]* to save the settings. To change the menu item without making any changes, press *[MODE]*.

Inclination

Press *[DOWN]*. The display shows $\overline{I} \overline{I} \overline{I}$. Press *[ENTER]* to then select a value between 000 and 255 for the head inclination by pressing *[UP]* and *[DOWN]*.

When the display shows the desired value press *[ENTER]* to save the settings. To change the menu item without making any changes, press *[MODE]*.

Fine tuning Inclination

Press *[DOWN]*. The display shows $\frac{1}{2} \frac{1}{2} F$. Press *[ENTER]* to then select a value between 000 and 255 to fine tune the head inclination by pressing *[UP]* and *[DOWN]*.

When the display shows the desired value press *[ENTER]* to save the settings. To change the menu item without making any changes, press *[MODE]*.

Inclination speed

Press *[DOWN]*. The display shows $\frac{1}{2} \frac{1}{2} S$. Press *[ENTER]* to then select a value between 000 and 255 for the head inclination speed by pressing *[UP]* and *[DOWN]*.

When the display shows the desired value press *[ENTER]* to save the settings. To change the menu item without making any changes, press *[MODE]*.

Colour

Press *[DOWN]*. The display shows $\frac{1}{2} \frac{1}{2} C$. Press *[ENTER]* to then select a value between 000 and 255 for the colour of the light effect by pressing *[UP]* and *[DOWN]*.

When the display shows the desired value press *[ENTER]* to save the settings. To change the menu item without making any changes, press *[MODE]*.

7.2.3 Programme menu

Press **[DOWN]** repeatedly while 'A001' is flashing on the display to select one of the 4 preprogrammed shows 'PrG1' to 'PrG4'. Press **[ENTER]** twice to open the Programme menu and to change show parameters as desired.

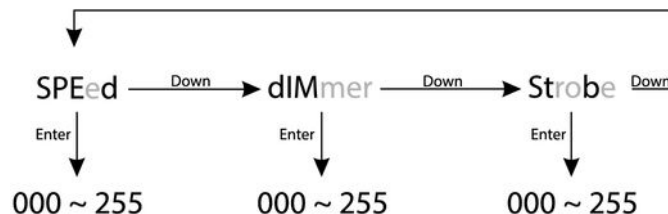

Speed

The display shows **SPEEd**. Press **[ENTER]** to then select a value between 000 and 255 for the duration for which the head should remain in each programmed position before it moves to the next by pressing **[UP]** and **[DOWN]**.

When the display shows the desired value press **[ENTER]** to save the settings. To change the menu item without making any changes, press **[MODE]**.

Dimmer

Press *[DOWN]*. The display shows \downarrow \uparrow . Press *[ENTER]* to then select a value between 000 and 255 for the light intensity of the show by pressing *[UP]* and *[DOWN]*.

When the display shows the desired value press *[ENTER]* to save the settings. To change the menu item without making any changes, press *[MODE]*.

Strobe

Press *[DOWN]*. The display shows 'Strobe'. Press *[ENTER]* to then select a value between 010 and 255 for the strobe frequency of the show by pressing *[UP]* and *[DOWN]*. Values between 000 and 009 have no function here.

When the display shows the desired value press *[ENTER]* to save the settings. To change the menu item without making any changes, press *[MODE]*. Press *[MODE]* twice to return to the function selection.

7.3 Settings menu

In this menu you can configure the device according your liking. All previous settings are retained even when you switch the device off and disconnect it from the mains. Press *[MODE]* and confirm with *[ENTER]* to open the settings menu SET .

Resetting to factory defaults

Press **[ENTER]** to call up the first menu item **F1**. With this function, you can reset the device to its factory default setting. All your previously adjusted settings are thereby irretrievably erased.

If you want to enable this function use **[UP]** and **[DOWN]** to select 'on' and confirm with **[ENTER]**. If you want to disable this function use **[UP]** and **[DOWN]** to select 'off' and confirm with **[ENTER]**.

Reset Machine

Press **[DOWN]**, repeatedly if necessary, and confirm with **[ENTER]** to call up the menu item **F5**. Use this function to reset positions and colours to their respective programmed parameters.

If you want to execute this function use **[UP]** and **[DOWN]** to select 'on' and confirm with **[ENTER]**. If you do not want to execute this function select 'off' and confirm with **[ENTER]**.

Master and Stand-alone operation

Press **[DOWN]**, repeatedly if necessary, and confirm with **[ENTER]** to call up the menu item **F4**. Use this function to specify whether the device operates as 'Master' (**F4**) and controls other units, or works in 'Stand-alone' mode (**F4**).

Use **[UP]** and **[DOWN]** to select the desired function and confirm with **[ENTER]**.

Auto and Sound

Press *[DOWN]*, repeatedly if necessary, and confirm with *[ENTER]* to call up the menu item *Auto*. Use this function to specify whether the device operates in Auto mode (*Auto*) or sound-controlled (*Sound*).

Use *[UP]* and *[DOWN]* to select the desired function and confirm with *[ENTER]*.

Microphone sensitivity

Press *[DOWN]*, repeatedly if necessary, and confirm with *[ENTER]* to call up the menu item *Micro*. Use this function to specify the sensitivity of the built-in microphone for sound-control.

Use *[UP]* and *[DOWN]* to select the desired sensitivity and confirm with *[ENTER]*.

Clear Display

Press *[DOWN]*, repeatedly if necessary, and confirm with *[ENTER]* to call up the menu item *Clear*. Use this function to specify whether you want the display to be always on or if it should turn itself off after approx. 25 seconds. Then only one dot is flashing on the display. When the display is off, press any button to restore illumination.

Use *[UP]* and *[DOWN]* to select 'on' if the display should be always on. Choose 'off' if the display should turn itself off after approx. 25 seconds. Confirm with *[ENTER]*.

Key Lock

Press *[DOWN]*, repeatedly if necessary, and confirm with *[ENTER]* to call up the menu item . Use this function to specify whether the buttons on the device are automatically locked against unintentional operation 30 seconds after the last operation.

Use *[UP]* and *[DOWN]* to select 'on' if the buttons should be locked. Select 'off' if the buttons should not be locked. Confirm with *[ENTER]*.



*To unlock the buttons during operation for 30 seconds, press *[MODE]*, *[DOWN]*, *[UP]* and *[ENTER]* successively.*

Information

Press *[DOWN]*, repeatedly if necessary, and confirm with *[ENTER]* to call up the menu item .

Use *[UP]* and *[DOWN]* to display information about manufacturer, model no., and date and time of production. Press *[ENTER]* to return to the parent menu level.

Operating hours counter

Press *[DOWN]*, repeatedly if necessary, and confirm with *[ENTER]* to call up the menu item $\overline{\text{PR}}\overline{\text{H}}$.

The display shows $\overline{\text{H}}\overline{\text{M}}\overline{\text{S}}$. Press *[ENTER]* to display the time in minutes since the last power-up. Press *[ENTER]* to clear the display.

Press *[DOWN]*. The display shows $\overline{\text{H}}\overline{\text{M}}\overline{\text{S}}$. Press *[ENTER]* to display the entire elapsed operating hours. Press *[ENTER]* to clear the display.

Press *[DOWN]*. The display shows $\overline{\text{H}}\overline{\text{M}}\overline{\text{S}}$. Press *[ENTER]* and use *[UP]* and *[DOWN]* to enter the password to delete the entire elapsed operating time. Upon delivery, the password is '001'. The display shows 'no'. Press *[UP]* or *[DOWN]* to set the display to 'YES'. Press *[ENTER]* to delete the entire elapsed operating hours.

Press *[MODE]*, repeatedly if necessary, until the display shows $\overline{\text{PR}}\overline{\text{H}}$ again.

Display inverting

Press *[DOWN]*, repeatedly if necessary, and confirm with *[ENTER]* to call up the menu item $\overline{\text{I}}\overline{\text{N}}\overline{\text{V}}$. Use this function to specify whether you want the display to appear normally or vertically inverted. This makes reading the display easier when the device is installed upside down.

Use *[UP]* and *[DOWN]* to select 'on' if the display should appear inverted. Select 'off' if the display should not appear inverted. Confirm with *[ENTER]*.

Motor Set

Press *[DOWN]*, repeatedly if necessary, and confirm with *[ENTER]* to call up the menu item $\overline{\text{P}}\overline{\text{S}}\overline{\text{E}}\overline{\text{L}}$. Press *[ENTER]* again. The display shows $\overline{\text{L}}\overline{\text{L}}\overline{\text{L}}\overline{\text{L}}$. This function allows you to specify whether the LED lights up in DMX mode during the movements of the device head or not.

Press *[ENTER]* to call up the function. Use *[UP]* and *[DOWN]* to select 'on' and press *[ENTER]* to enable this function (LED 'off' on DMX-controlled movements). Select 'OFF' and press *[ENTER]* to disable this function (LED 'on' on DMX-controlled movements).

Press *[MODE]*, repeatedly if necessary, until the display shows $\overline{\text{P}}\overline{\text{S}}\overline{\text{E}}\overline{\text{L}}$ again.

Recording scenes

Press *[DOWN]*, repeatedly if necessary, and confirm with *[ENTER]* to call up the menu item $\overline{\text{R}}\overline{\text{E}}\overline{\text{C}}$. Here you can assign the scene currently performed by the device to the memory location for the scene $\overline{\text{L}}\overline{\text{L}}\overline{\text{L}}$.

Press *[ENTER]*. The display shows 'no'. Press *[UP]* or *[DOWN]* and confirm the display 'Yes' with *[ENTER]* to save the scene. This will overwrite the previously saved parameters for this scene.

Press *[MODE]*, repeatedly if necessary, until the display shows $\overline{\text{R}}\overline{\text{E}}\overline{\text{C}}$ again.

Advanced menu

Press *[DOWN]*, repeatedly if necessary, and confirm with *[ENTER]* to call up the menu item *PUK*. Here you can change the password that protects the access to some menu options to prevent unauthorized access. The display shows *PUK n1 n2*.

Press *[UP]* or *[DOWN]* and confirm with *[ENTER]* to call up the menu item *PASSWord PARAME*. Press again *[ENTER]*. Keep *[DOWN]* pressed until PUK Code 638 is displayed. Press *'ENTER'*. The display shows *n001 F4 P1*. Confirm with *[ENTER]*. The display shows the current password. Use *[UP]* and *[DOWN]* to select a new password and press *'ENTER'* to save it.

Press *[MODE]* repeatedly to return to the respectively parent menu level or to leave the menu.



If you enter an incorrect PUK code, the error message 'Password Err' scrolls on the display until you press ENTER. Then enter the correct PUK code.

7.4 Functions in 3-channel DMX mode (8-bit)

Channel	Value	Function
1	0...255	Rotation (pan) (0° up to the maximum value of the Pan range of 540°)
2	0...255	Inclination (tilt) (0° up to the maximum value of the Tilt range of 230°)
3	0...255	Master dimmer 0 – 100%

7.5 Functions in 8-channel DMX mode (16-bit)

Channel	Value	Function
1	0...255	Rotation (pan) (0° up to the maximum value of the Pan range of 540°)
2	0...255	Fine adjustment rotation (pan)
3	0...255	Inclination (tilt) (0° up to the maximum value of the Tilt range of 230°)
4	0...255	Fine adjustment inclination (tilt)

Channel	Value	Function	
5	0...255	Motor speed (slow to fast)	
6	0...255	Master dimmer 0 – 100%	
7	0...255	000...049	No function
		050...059	Intensity Red
		060...069	Intensity Green
		070...079	Intensity Blue
		080...089	Intensity White
		090...099	Intensity Yellow
		100...109	Intensity Cyan
		110...119	Intensity Purple
		120...129	Intensity All White
		130...139	Scene 09 (empty)
140...149	Programme 1		

Channel	Value	Function	
		150...159	Programme 2
		160...169	Programme 3
		170...179	Programme 4
		180...189	Programme 5
		190...199	Programme 6
		200...209	Programme 7
		210...219	Programme 8
		220...229	Programme 9
		230...233	Empty
		234...236	Reset
		237...249	Empty
	250...255	Sound-controlled operation	
8	0...255	000...255	Speed / Sensitivity

7.6 Functions in 13-channel DMX mode (16-bit)

Channel	Value	Function	
1	0...255	Rotation (pan) (0° up to the maximum value of the Pan range of 540°)	
2	0...255	Fine adjustment rotation (pan)	
3	0...255	Inclination (tilt) (0° up to the maximum value of the Tilt range of 230°)	
4	0...255	Fine adjustment inclination (tilt)	
5	0...255	Motor speed (slow to fast)	
6	0...255	Master dimmer 0 – 100%	
7	0...255	000...009	No function (open)
		010...255	Strobe effect (1 Hz...25 Hz)
8	0...255	Intensity Red	
9	0...255	Intensity Green	
10	0...255	Intensity Blue	

Channel	Value	Function	
11	0...255	Intensity White	
12	0...255	000...049	No function
		050...059	Intensity Red
		060...069	Intensity Green
		070...079	Intensity Blue
		080...089	Intensity White
		090...099	Intensity Yellow
		100...109	Intensity Cyan
		110...119	Intensity Purple
		120...129	Intensity All White
		130...139	Scene 09 (empty)
		140...149	Programme 1
		150...159	Programme 2

Channel	Value	Function	
		160...169	Programme 3
		170...179	Programme 4
		180...189	Programme 5
		190...199	Programme 6
		200...209	Programme 7
		210...219	Programme 8
		220...229	Programme 9
		230...233	Empty
		234...236	Reset
		237...249	Empty
		250...255	Sound-controlled operation
13	0...255	000...255	Speed / Sensitivity

8 Remote control

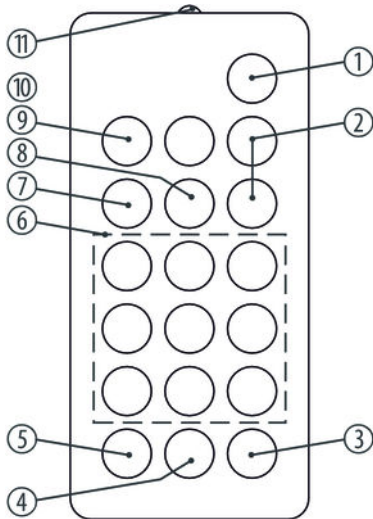

To use the remote control, point its infrared diode at the infrared sensor on the unit and press the desired buttons. The maximum operating distance is about 9 m. The device will only respond to the remote control signals if it is not controlled via DMX.

1 [STAND BY]

Stops the automatic mode and blackouts the unit. The display shows 'StoP'. In this mode, the device responds to the remote control.

2 [Dimmer + / -]

Adjusts the light intensity between 0 and 100%. Press [Dimmer +] repeatedly or keep the button pressed to increase the light intensity. Press [Dimmer -] repeatedly or keep the button pressed to decrease the light intensity.

3 [SOUND OFF]

Deactivates the sound-control.

4	<i>[SHOW]</i> To call one of the 4 preprogrammed automatic shows, press this button followed by the number button 1 – 4 for the desired show. To cancel a show, press <i>[STAND BY]</i> .									
5	<i>[SOUND ON]</i> Activates the 'Sound Control' mode.									
6	Number buttons These buttons allow you to trim the rotation (X) and tilt (Y) of the device head: <table><tr><td>Button 1: X- & Y+</td><td>Button 4: X-</td><td>Button 7: X- & Y-</td></tr><tr><td>Button 2: Y+</td><td>Button 5: Centre</td><td>Button 8: Y-</td></tr><tr><td>Button 3: X+ & Y+</td><td>Button 6: X+</td><td>Button 9: X+ & Y-</td></tr></table>	Button 1: X- & Y+	Button 4: X-	Button 7: X- & Y-	Button 2: Y+	Button 5: Centre	Button 8: Y-	Button 3: X+ & Y+	Button 6: X+	Button 9: X+ & Y-
Button 1: X- & Y+	Button 4: X-	Button 7: X- & Y-								
Button 2: Y+	Button 5: Centre	Button 8: Y-								
Button 3: X+ & Y+	Button 6: X+	Button 9: X+ & Y-								
7	<i>[STROBE]</i> Enables the Strobe function for the current light scene. Then press one of the number buttons 2 – 9 for the desired strobe frequency. Press number button 1 to turn the strobe function off.									

8	<i>[COLOR]</i> To call various colours for the current light scene. Then press one of the number buttons 1 – 8 for the desired colour.
9	<i>[FULL ON]</i> Press this button to call the programmed light scene.
10	<i>[GOBO]</i> To call various Gobos for the current light scene. Then press one of the number buttons 1 – 8 for the desired Gobo.
11	Infrared diode Sends the infrared signals to the device.

9 Technical specifications

Number of DMX channels	3, 8, 13
LED	1 × 30 W High Performance RGBW QuadColour LED
Voltage supply	AC 100 – 240 V ~ , 50/60 Hz
Power consumption	46 W
Fuse	5 mm × 20 mm, 2 A, 250 V, fast-acting
Dimensions (W × H × D), when light beam pointing upwards	172 mm × 235 mm × 174 mm
Weight	3 kg

10 Plug and connection assignments

Introduction

This chapter will help you select the right cables and plugs to connect your valuable equipment so that a perfect light experience is guaranteed.

Please take our tips, because especially in 'Sound & Light' caution is indicated: Even if a plug fits into a socket, the result of an incorrect connection may be a destroyed DMX controller, a short circuit or 'just' a not working light show!

DMX connections

The unit offers a 3-pin XLR socket for DMX output and a 3-pin XLR plug for DMX input. Please refer to the drawing and table below for the pin assignment of a suitable XLR plug.



Pin	Configuration
1	Ground, shielding
2	Signal inverted (DMX-, 'cold signal')
3	Signal (DMX+, 'hot signal')

11 Troubleshooting



NOTICE!

Possible data transmission errors

For error-free operation make use of dedicated DMX cables and do not use ordinary microphone cables.

Never connect the DMX input or output to audio devices such as mixers or amplifiers.

In the following we list a few common problems that may occur during operation. We give you some suggestions for easy troubleshooting:

Symptom	Remedy
The unit does not work, no light, the fan does not run	Check the mains connection and the main fuse.
No response to the DMX controller	1. Check the DMX connectors and cables for proper connection.
	2. Check the address settings and the DMX polarity.
	3. Try using another DMX controller.
	4. Check to see if the DMX cables run near or alongside to high voltage cables that may cause damage or interference to DMX interface circuits.

If the procedures recommended above do not succeed, please contact our Service Center. You can find the contact information at www.thomann.de.

12 Cleaning

Optical lenses

Clean the optical lenses, that are accessible from the outside, regularly in order to optimize the light output. The frequency of cleaning depends on the operating environment: wet, smoky or particularly dirty surroundings can cause more accumulation of dirt on the optics of the device.

- Clean with a soft cloth using our lamp and lens cleaner (item no. 280122).
- Always dry the parts carefully.

Fan grids

The fan grids of the device must be cleaned on a regular basis to remove dust and dirt. Before cleaning, switch off the device and disconnect AC-powered devices from the mains. Use a lint-free damp cloth for cleaning. Never use solvents or alcohol for cleaning.

13 Protecting the environment

Disposal of the packaging material



For the transport and protective packaging, environmentally friendly materials have been chosen that can be supplied to normal recycling.

Ensure that plastic bags, packaging, etc. are properly disposed of.

Do not just dispose of these materials with your normal household waste, but make sure that they are fed to a recovery. Please follow the notes and markings on the packaging.

Disposal of batteries



Batteries must not be disposed of as domestic waste or thrown into fire. Dispose of the batteries according to national or local regulations regarding hazardous waste. To protect the environment, dispose of empty batteries at your retail store or at appropriate collection sites.

Disposal of your old device



This product is subject to the European Waste Electrical and Electronic Equipment Directive (WEEE). Do not dispose with your normal household waste.

Dispose this device through an approved waste disposal firm or through your local waste facility. When discarding the device, comply with the rules and regulations that apply in your country. If in doubt, consult your local waste disposal facility.



