



fungeneration

PicoWash 40 Pixel
Quad LED
moving head

Musikhaus Thomann
Thomann GmbH
Hans-Thomann-Straße 1
96138 Burgebrach
Deutschland
Telephone: +49 (0) 9546 9223-0
E-mail: info@thomann.de
Internet: www.thomann.de

20.11.2017, ID: 372705 (V2)

Table of contents

1	General information	5
	1.1 Further information.....	6
	1.2 Notational conventions.....	7
	1.3 Symbols and signal words.....	8
2	Safety instructions	11
3	Features	18
4	Installation	19
5	Starting up	23
6	Connections and operating elements	25
7	Operating	28
	7.1 Starting the device.....	28
	7.2 Function selection.....	29
	7.2.1 DMX menu.....	30
	7.2.2 Scene menu.....	33
	7.2.3 Programme menu.....	36

7.3	Settings menu.....	38
7.4	Functions in 3-channel DMX mode (8-bit).....	46
7.5	Functions in 8-channel DMX mode (16-bit).....	46
7.6	Functions in 13-channel DMX mode (16-bit).....	49
7.7	Functions in 25-channel DMX mode (16-bit).....	52
8	Remote control.....	56
9	Technical specifications.....	59
10	Plug and connection assignments.....	60
11	Troubleshooting.....	61
12	Cleaning.....	63
13	Protecting the environment.....	64

1 General information

This manual contains important instructions for the safe operation of the unit. Read and follow the safety instructions and all other instructions. Keep the manual for future reference. Make sure that it is available to all those using the device. If you sell the unit please make sure that the buyer also receives this manual.

Our products are subject to a process of continuous development. Thus, they are subject to change.

1.1 Further information

On our website (www.thomann.de) you will find lots of further information and details on the following points:

Download	This manual is also available as PDF file for you to download.
Keyword search	Use the search function in the electronic version to find the topics of interest for you quickly.
Online guides	Our online guides provide detailed information on technical basics and terms.
Personal consultation	For personal consultation please contact our technical hotline.
Service	If you have any problems with the device the customer service will gladly assist you.

1.2 Notational conventions

This manual uses the following notational conventions:

Letterings

The letterings for connectors and controls are marked by square brackets and italics.

Examples: *[VOLUME]* control, *[Mono]* button.

Displays

Texts and values displayed on the device are marked by quotation marks and italics.

Examples: *'24ch'*, *'OFF'*.

Text input

Text inputs that are carried out on the device are indicated by typewriter font.

Example: 2323

Cross-references



References to other locations in this manual are identified by an arrow and the specified page number. In the electronic version of the manual, you can click the cross-reference to jump to the specified location.

Example: See  'Cross-references' on page 7.

1.3 Symbols and signal words

In this section you will find an overview of the meaning of symbols and signal words that are used in this manual.

Signal word	Meaning
DANGER!	This combination of symbol and signal word indicates an immediate dangerous situation that will result in death or serious injury if it is not avoided.
WARNING!	This combination of symbol and signal word indicates a possible dangerous situation that can result in death or serious injury if it is not avoided.
CAUTION!	This combination of symbol and signal word indicates a possible dangerous situation that can result in minor injury if it is not avoided.
NOTICE!	This combination of symbol and signal word indicates a possible dangerous situation that can result in material and environmental damage if it is not avoided.
Warning signs	Type of danger
	Warning – high-voltage.

Warning signs	Type of danger
 A yellow triangular warning sign with a black border. Inside the triangle, there is a black silhouette of a crane hook lifting a rectangular load.	Warning – suspended load.
 A yellow triangular warning sign with a black border. Inside the triangle, there is a black exclamation mark.	Warning – danger zone.

2 Safety instructions

Intended use

This device is intended to be used as moving-head spotlight. The device is designed for professional use and is not suitable for use in households. Use the device only as described in this user manual. Any other use or use under other operating conditions is considered to be improper and may result in personal injury or property damage. No liability will be assumed for damages resulting from improper use.

This device may be used only by persons with sufficient physical, sensorial, and intellectual abilities and having corresponding knowledge and experience. Other persons may use this device only if they are supervised or instructed by a person who is responsible for their safety.

Safety



DANGER!

Danger for children

Ensure that plastic bags, packaging, etc. are disposed of properly and are not within reach of babies and young children. Choking hazard!

Ensure that children do not detach any small parts (e.g. knobs or the like) from the unit. They could swallow the pieces and choke!

Never let children unattended use electrical devices.



DANGER!

Electric shock caused by high voltages inside

Within the device there are areas where high voltages may be present. Never remove any covers.

There are no user-serviceable parts inside.

Do not use the device if covers, protectors or optical components are missing or damaged.



DANGER!

Electric shock caused by short-circuit

Always use proper ready-made insulated mains cabling (power cord) with a protective contact plug. Do not modify the mains cable or the plug. Failure to do so could result in electric shock/death or fire. If in doubt, seek advice from a registered electrician.



WARNING!

Eye damage caused by high light intensity

Never look directly into the light source.



WARNING!

Risk of epileptic shock

Strobe lighting can trigger seizures in photosensitive epilepsy. Sensitive persons should avoid looking at strobe lights.



WARNING!

Risk of injury by falling off

Make sure that the installation complies with the standards and rules that apply in your country. Always secure the device with a secondary safety attachment, such as a safety cable or a safety chain.

The carrying capacity of the truss or other mounting must be sufficient for the intended number of devices. Note that the movement of the head may additionally stress the load-bearing structures.



CAUTION!

Risk of injury due to movements of the device

The head of the device can move quickly (pan, tilt) and can produce very bright light. This is also valid immediately after you turn on the device, when the device operates in automatic mode or under remote control and when you turn off a DMX controller that is connected to the device. Persons staying near the device could be injured or frightened.

Before you turn on the device and during the operation, always ensure that nobody stays close to the device. If work has to be performed in the area of movement or in the near vicinity of the device, it must remain turned off.



NOTICE!

Risk of fire

Do not block areas of ventilation. Do not install the device near any direct heat source. Keep the device away from naked flames.



NOTICE!

Operating conditions

This device has been designed for indoor use only. To prevent damage, never expose the device to any liquid or moisture. Avoid direct sunlight, heavy dirt, and strong vibrations.

The device must not be moved while it is in use.



NOTICE!

Power supply

Before connecting the device, ensure that the input voltage (AC outlet) matches the voltage rating of the device and that the AC outlet is protected by a residual current circuit breaker. Failure to do so could result in damage to the device and possibly injure the user.

Unplug the device before electrical storms occur and when it is unused for long periods of time to reduce the risk of electric shock or fire.



NOTICE!

Possible staining

The plasticiser contained in the rubber feet of this product may possibly react with the coating of your parquet, linoleum, laminate or PVC floor and after some time cause permanent dark stains.

In case of doubt, do not put the rubber feet directly on the floor, but use felt-pad floor protectors or a carpet.

3 Features

The moving head is particularly suitable for professional lighting tasks, for example at events, on rock stages, in theatres and musicals, in discotheques as well as for mobile DJ's and entertainer.

Special features of the device:

- Two movable axes with 8 or 16 bit resolution:
 - Tilt (180°)
 - Pan (540°)
- Pan and Tilt invertible
- 4 × 10 W Quad Colour RGBW LEDs
- Beam angle 28°
- Control via DMX (3, 8, 13 or 25 channels) and via buttons and display on the unit
- 9 preprogrammed automatic shows
- Sound control
- Electronic dimmer 0...100%
- Shutter frequency 0...20 Hz
- Omega bracket and infrared remote control included

4 Installation

Unpack and carefully check that there is no transportation damage before using the unit. Keep the equipment packaging. To fully protect the device against vibration, dust and moisture during transportation or storage use the original packaging or your own packaging material suitable for transport or storage, respectively.



WARNING!

Risk of injury by falling off

Make sure that the installation complies with the standards and rules that apply in your country. Always secure the device with a secondary safety attachment, such as a safety cable or a safety chain.

The carrying capacity of the truss or other mounting must be sufficient for the intended number of devices. Note that the movement of the head may additionally stress the load-bearing structures.



CAUTION!

Risk of injury due to movements of the device

The head of the device can move quickly (pan, tilt) and can produce very bright light. This is also valid immediately after you turn on the device, when the device operates in automatic mode or under remote control and when you turn off a DMX controller that is connected to the device. Persons staying near the device could be injured or frightened.

Before you turn on the device and during the operation, always ensure that nobody stays close to the device. If work has to be performed in the area of movement or in the near vicinity of the device, it must remain turned off.



NOTICE!

Risk of overheating

Always ensure sufficient ventilation.

The ambient temperature must always be below 40 °C (104 °F).



NOTICE!

Possible damage caused by movements of the device

Always ensure that enough space is free around the device for the movements of the head (pan, tilt).



NOTICE!

Possible data transmission errors

For error-free operation make use of dedicated DMX cables and do not use ordinary microphone cables.

Never connect the DMX input or output to audio devices such as mixers or amplifiers.



Please note that this device must not be connected to a dimmer.

Mounting options

You can install the device on the wall, ceiling or floor.

The threads on the housing bottom are used to secure the supplied Omega bracket or truss clamps.

5 Starting up

Create all connections while the device is off. Use the shortest possible high-quality cables for all connections. Take care when running the cables to prevent tripping hazards.

Connections in DMX mode

Connect the DMX input of the device to the DMX output of a DMX controller or another DMX device. Connect the output of the first DMX device to the input of the second one, and so on to form a daisy chain. Always ensure that the output of the last DMX device in the daisy chain is terminated with a resistor ($110\ \Omega$, $\frac{1}{4}\text{ W}$).

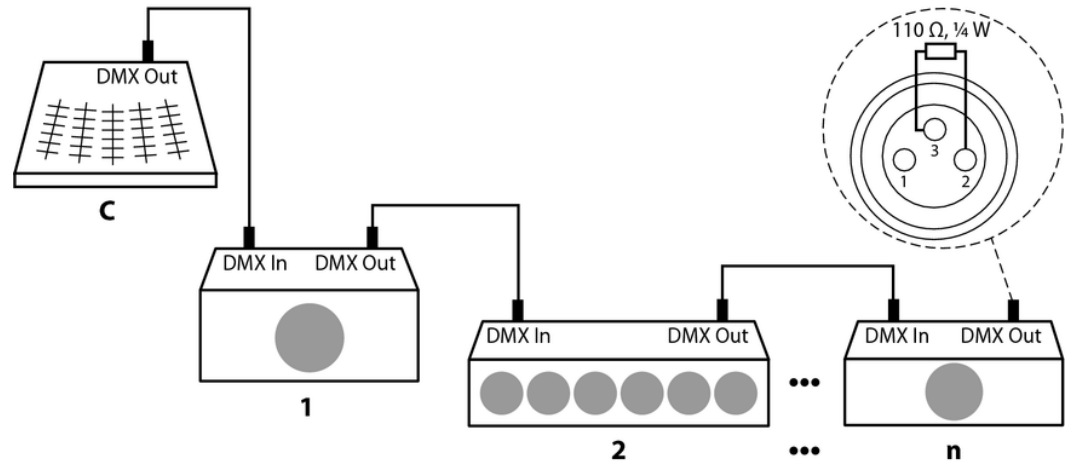

6 Connections and operating elements

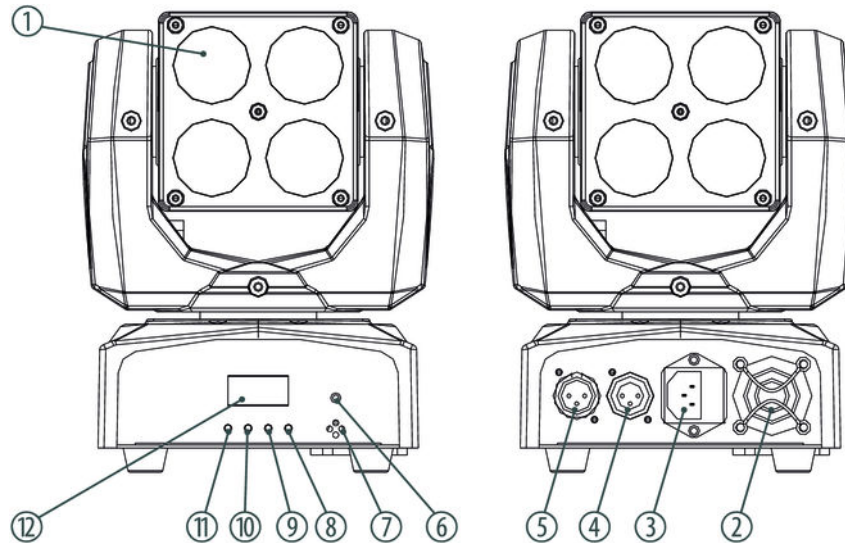

PicoWash 40 Pixel Quad LED

1	Light aperture.
2	Fan.
3	IEC chassis plug for the mains cable with fuse holder.
4	<i>[DMX Out]</i> DMX output.
5	<i>[DMX In]</i> DMX input.
6	Infrared sensor for receiving remote control signals.
7	Microphone for sound control.
8	<i>[ENTER]</i> Calls the menu for the respective operation mode, confirms a set value.
9	<i>[DOWN]</i> Decreases the displayed value by one and selects menu items.

10	<i>[UP]</i> Increases the displayed value by one and selects menu items.
11	<i>[MODE]</i> Calls the settings menu, skips one menu level back and closes an opened submenu without saving any changes.
12	Display.

7 Operating

7.1 Starting the device



CAUTION!

Risk of injury due to movements of the device

The head of the device can move quickly (pan, tilt) and can produce very bright light. This is also valid immediately after you turn on the device, when the device operates in automatic mode or under remote control and when you turn off a DMX controller that is connected to the device. Persons staying near the device could be injured or frightened.

Before you turn on the device and during the operation, always ensure that nobody stays close to the device. If work has to be performed in the area of movement or in the near vicinity of the device, it must remain turned off.

Connect the device to the power supply to start operation. After a few seconds, the fans start to work, the head moves to the home positions for rotation (pan) and inclination (tilt). After some more seconds, '*Addr:XXX NoSignal*' is flashing in the display. The device is now operational.

7.2 Function selection

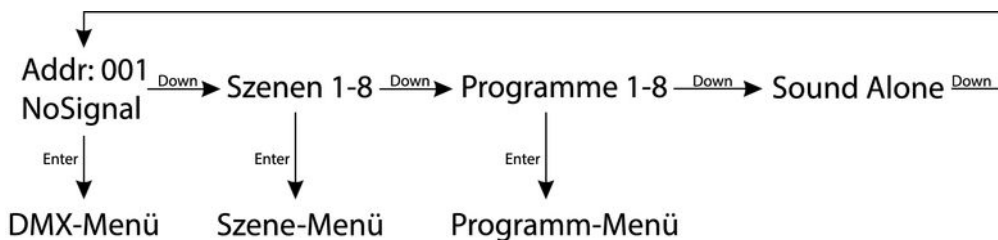

Press repeatedly *[DOWN]* while 'A001' is flashing in the display to call up one of 8 preprogrammed scenes, one of 8 programmes or to set the device to sound-controlled mode.

7.2.1 DMX menu

Press [ENTER] while 'Addr:XXX NoSignal' is flashing in the display to select the DMX menu. Press [ENTER] to call up the first menu item.

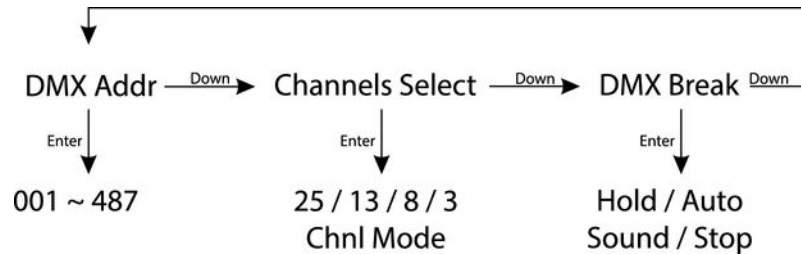

DMX address

The display shows 'DMX Addr'. Press *[ENTER]* to then select with *[UP]* and *[DOWN]* the first DMX channel to be used by the device (DMX address) in a range between 001 to max. 509.

When the display shows the desired value press *[ENTER]* to save the setting and then *[DOWN]* to change to the next menu item. To change the menu item without making changes, press *[MODE]*.

Make sure that this number matches the configuration of your DMX controller. The following table shows the highest possible DMX address for the various DMX modes

Mode	Highest possible DMX address
3 channels	510
8 channels	505
13 channels	500
25 channels	488

Selecting the number of DMX channels

The display shows '*Channels Select*'. Press *[ENTER]* to then select with *[UP]* and *[DOWN]* the number of DMX channels to be used by the device. Control via 3, 8, 13 or 25 channels is available.

When the display shows the desired value press *[ENTER]* to save the setting and then *[DOWN]* to change to the next menu item. To change the menu item without making changes, press *[MODE]*.

DMX break

The display shows '*DMX Break*'. Press *[ENTER]* to then select with *[UP]* and *[DOWN]* one of the options for the behaviour of the device in case the DMX connection is interrupted. Choose 'Hold' if you want the device in that case to maintain the state that corresponds to the last received DMX signal. Choose 'Hold' if you want the device in that case to perform an automatic run. Choose 'Sound' if you want the device in that case to perform a sound-controlled automatic run. Choose 'Sound' if you want the device in that case to return to its home position.

When the display shows the desired value press *[ENTER]* to save the setting and then *[MODE]* twice to return to the function selection. To change the menu item without making changes, press *[MODE]*.

7.2.2 Scene menu

Press **[DOWN]** while 'Addr:XXX NoSignal' is flashing in the display to select the scene 'Red Alone'. Press **[ENTER]** twice to open the Scene menu and to change scene parameters as desired.

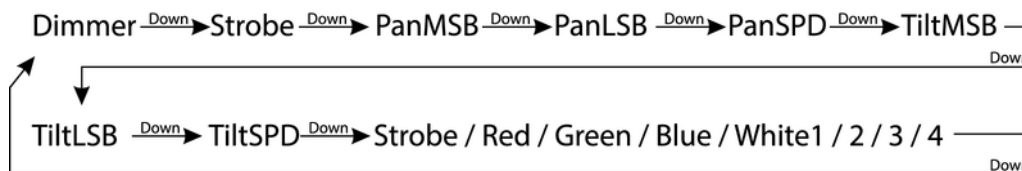

With **[UP]** and **[DOWN]** you can select the menu items explained in the following table; press **ENTER** to call up the respectively connected function. Use **[UP]** and **[DOWN]** to change the respectively indicated value. When the display shows the desired value press **[ENTER]** to save the settings. With **[MODE]**, you get to the parent menu level.

Display	Description	Value range
Dimmer	Overall intensity of all 4 LEDs	0 (low) – 255 (high)
Strobe	Strobe frequency	10 (slow) – 255 (fast)

Display	Description	Value range
PanMSB	Rotation	0 – 255
PanLSB	Fine tuning Rotation	0 and 255
PanSPD	Rotation speed	0 (fast) – 255 (slow)
TiltMSB	Inclination	0 – 255
TiltLSB	Fine tuning Inclination	0 and 255
TiltSPD	Tilting motion speed	0 (fast) – 255 (slow)
Strobe1	Strobe frequency LED bottom right	10 (slow) – 255 (fast)
Red1	Intensity 'Red' LED bottom right	0 (off) – 255 (max.)
Green1	Intensity 'Green' LED bottom right	0 (off) – 255 (max.)
Blue1	Intensity 'Blue' LED bottom right	0 (off) – 255 (max.)
White1	Intensity 'White' LED bottom right	0 (off) – 255 (max.)
Strobe2	Strobe frequency LED bottom left	10 (slow) – 255 (fast)
Red2	Intensity 'Red' LED bottom left	0 (off) – 255 (max.)

Display	Description	Value range
Green2	Intensity 'Green' LED bottom left	0 (off) – 255 (max.)
Blue2	Intensity 'Blue' LED bottom left	0 (off) – 255 (max.)
White2	Intensity 'White' LED bottom left	0 (off) – 255 (max.)
Strobe3	Strobe frequency LED top left	10 (slow) – 255 (fast)
Red3	Intensity 'Red' LED top left	0 (off) – 255 (max.)
Green3	Intensity 'Green' LED top left	0 (off) – 255 (max.)
Blue3	Intensity 'Blue' LED top left	0 (off) – 255 (max.)
White3	Intensity 'White' LED top left	0 (off) – 255 (max.)
Strobe4	Strobe frequency LED top right	10 (slow) – 255 (fast)
Red4	Intensity 'Red' LED top right	0 (off) – 255 (max.)
Green4	Intensity 'Green' LED top right	0 (off) – 255 (max.)
Blue4	Intensity 'Blue' LED top right	0 (off) – 255 (max.)
White4	Intensity 'White' LED top right	0 (off) – 255 (max.)



Any 'Strobe' setting except '0' overrides settings 'Strobe1–4' for individual LEDs.

If you have left the menu and 'Red Alone' is displayed again, press [DOWN] to consecutively select the scenes 'Green Alone', 'Blue Alone', 'White Alone', 'Yellow Alone', 'Cyan Alone', 'Purple Alone', 'Red Alone' and 'AllWhite Alone' which you can change as described.

7.2.3 Programme menu

Press repeatedly [DOWN] while 'Addr:XXX NoSignal' is flashing in the display to select one of the 9 preprogrammed shows 'Prog 1' to 'Prog 9'. Press [ENTER] twice to open the Programme menu and to change show parameters as desired.

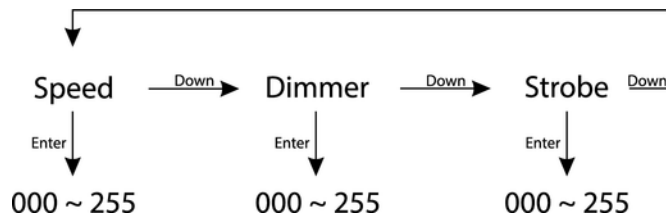
**Speed**

The display shows 'Speed'. Press [ENTER] to then select with [UP] and [DOWN] a value between 000 and 255 for the process speed of the show.

When the display shows the desired value press [ENTER] to save the settings. To change the menu item without making changes, press [MODE].

Dimmer

Press [DOWN]. The display shows 'Dimmer'. Press [ENTER] to then select with [UP] and [DOWN] a value between 000 and 255 for the light intensity of the show.

When the display shows the desired value press [ENTER] to save the settings. To change the menu item without making changes, press [MODE].

Strobe

Press *[DOWN]*. The display shows 'Strobe'. Press *[ENTER]* to then select with *[UP]* and *[DOWN]* a value between 010 and 255 for the strobe frequency of the show. Values between 000 and 009 have no function here.

When the display shows the desired value press *[ENTER]* to save the settings. To change the menu item without making changes, press *[MODE]*. Press *[MODE]* twice to return to the function selection.

7.3 Settings menu

In this menu you can configure the device according your liking. All previous settings are retained even when you switch the device off and disconnect it from the mains. Press *[MODE]* and confirm with *[ENTER]* to open the settings menu 'Set Menu'.

Resetting to factory defaults

Press *[ENTER]* to call up the first menu item *'Reload Default'*. With this function, you can reset the device to factory default setting. All your previously adjusted settings are thereby being irretrievably erased.

If you want to enable this function use *[UP]* and *[DOWN]* to select *'ON'* and confirm with *[ENTER]*. If you want to disable this function use *[UP]* and *[DOWN]* to select *'OFF'* and confirm with *[ENTER]*.

Reset Machine

Press, if necessary repeatedly, *[DOWN]* and confirm with *[ENTER]* to call up the menu item *'Reset Machine'*. Use this function to reset positions and colours to their respective programmed parameters.

If you want to execute this function use *[UP]* and *[DOWN]* to select *'ON'* and confirm with *[ENTER]*. If you do not want to execute this function select *'OFF'* and confirm with *[ENTER]*.

Master and Stand-alone operation

Press, if necessary repeatedly, *[DOWN]* and confirm with *[ENTER]* to call up the menu item *'Master & Alone'*. Use this function to specify whether the device operates as *'Master'* and controls other units, or works in *'Stand-alone'* mode.

Use *[UP]* and *[DOWN]* to select the desired function and confirm with *[ENTER]*.

Auto and Sound

Press, if necessary repeatedly, *[DOWN]* and confirm with *[ENTER]* to call up the menu item 'Auto & Sound'. Use this function to specify whether the device operates in Auto mode or sound-controlled.

Use *[UP]* and *[DOWN]* to select the desired function and confirm with *[ENTER]*.

Microphone sensitivity

Press, if necessary repeatedly, *[DOWN]* and confirm with *[ENTER]* to call up the menu item 'MICSense'. Use this function to specify the sensitivity of the built-in microphone for sound-control.

Use *[UP]* and *[DOWN]* to select the desired sensitivity and confirm with *[ENTER]*.

Clear Display

Press, if necessary repeatedly, *[DOWN]* and confirm with *[ENTER]* to call up the menu item 'Clear Display'. Use this function to specify whether you want the display to be always bright or if it should dim out after approx. 25 seconds. When the display is dimmed, press any button to restore full illumination.

Use *[UP]* and *[DOWN]* to select 'Always On' if the display should always light up bright. Choose 'Delay Off' if the display should dim out after approx. 25 seconds. Confirm with *[ENTER]*.

Key Lock

Press, if necessary repeatedly, *[DOWN]* and confirm with *[ENTER]* to call up the menu item 'Key Lock'. Use this function to specify whether the buttons on the device are being automatically locked against unintentional operation 30 seconds after the last operation.

Use *[UP]* and *[DOWN]* to select 'Lock: On' if the buttons should get locked. Select 'Lock: Off' if the buttons should not get locked. Confirm with *[ENTER]*.



To unlock the buttons during operation for 30 seconds, press successively *[MODE]*, *[DOWN]*, *[UP]* and *[ENTER]*.

Information

Press, if necessary repeatedly, *[DOWN]* and confirm with *[ENTER]* to call up the menu item 'Information'.

Use *[UP]* and *[DOWN]* to display information about manufacturer, model no. date and time of production. Press *[ENTER]* to return to the parent menu level.

Operating hours counter

Press, if necessary repeatedly, *[DOWN]* and confirm with *[ENTER]* to call up the menu item *'Machine Timer'*.

The display shows *'ThisTime'*. Press *[ENTER]* to display the time since the last power-up. An *'M'* behind the numerical value stands for minutes, an *'H'* stands for hours. Press *[ENTER]* to clear the display.

Press *[DOWN]*. The display shows *'TotlTime'*. Press *[ENTER]* to display the entire elapsed operating hours. Press *[ENTER]* to clear the display.

Press *[DOWN]*. The display shows *'ClearTotal'*. Press *[ENTER]* and use *[UP]* and *[DOWN]* to enter the password to delete the entire elapsed operating time. Upon delivery, the password is *'001'*. The display shows *'ClearTotal:No'*. Press *[UP]* or *[DOWN]* to set the display to *'ClearTotal:OK'*. Press *[ENTER]* to delete the entire elapsed operating hours.

Press, if necessary repeatedly, *[MODE]* until the display shows *'Machine Timer'* again.

Motor Set

Press, if necessary repeatedly, *[DOWN]* and confirm with *[ENTER]* to call up the menu item 'Motor Set'. This function allows you to specify whether the LEDs light up in DMX mode during the movements of the device head or not.

The display shows 'Motor Set'. Press *[ENTER]* to select the function 'Move Blackout' and confirm with *[ENTER]*. Then use *[UP]* or *[DOWN]* to select 'ON' and press *[ENTER]* to enable this function (LEDs 'off' on DMX-controlled movements). Select 'OFF' and press *[ENTER]* to disable this function (LEDs 'on' on DMX-controlled movements).

Press, if necessary repeatedly, *[MODE]* until the display shows 'Motor Set' again.

Inverting Pan / Tilt

Press, if necessary repeatedly, *[DOWN]* and confirm with *[ENTER]* to call up the menu item 'Motor Set'. This function allows you to invert the Pan and Tilt movement direction.

The display shows 'Motor Set'. Confirm with *[ENTER]*. Press *[UP]* or *[DOWN]* until the display shows 'Motor Calibrate'. Confirm with *[ENTER]*. Now you can use *[UP]* or *[DOWN]* to choose between 'Pan Motor' (reversing the direction of rotation) and 'Tilt Motor' (reversing the direction of inclination). Press *[ENTER]* when the desired option is displayed and then press *[UP]* or *[DOWN]* until the display shows 'Reverse'. Confirm with *[ENTER]*. Use *[UP]* or *[DOWN]* to select 'Yes' to reverse the direction, or 'No' to not reverse the direction. Confirm with *[ENTER]*.

Recording scenes

Press, if necessary repeatedly, *[DOWN]* and confirm with *[ENTER]* to call up the menu item *'Record Scene'*. Here you can assign the scene currently performed by the device to one of 8 memory locations for the scenes *'Red'*, *'Green'*, *'Blue'*, *'White'*, *'Yellow'*, *'Cyan'*, *'Purple'* and *'AllWhite'*.

Press *[ENTER]* and use *[UP]* and *[DOWN]* to select the desired memory location. Press *[ENTER]* and use *[UP]* and *[DOWN]* to select *'Yes'*. Confirm with *[ENTER]* to save the scene. This will overwrite the previously saved parameters for this scene.

Press, if necessary repeatedly, *[MODE]* until the display shows *'Record Scene'* again.

Advanced menu

Press, if necessary repeatedly, *[DOWN]* and confirm with *[ENTER]* to call up the menu item 'Advance Menu'. Here you can change the password that protects the access to some menu options to prevent unauthorized access. The display shows 'Warning'.

Press *[UP]* or *[DOWN]* and confirm with *[ENTER]* to call up the menu item 'PassWordManage'. Keep *[DOWN]* pressed until PUK Code '638' is displayed. Press 'ENTER'. The display shows 'Modify P.W.'. Confirm with *[ENTER]*. The display shows the current password. Use *[UP]* and *[DOWN]* to select a new password and press 'ENTER' to save it.

Press repeatedly *[MODE]* to return to the respectively parent menu level or to leave the menu.



If you have entered an incorrect PUK code 'PassWord Err!!!' is flashing three times in the display. Then enter the correct PUK code.

7.4 Functions in 3-channel DMX mode (8-bit)

Channel	Value	Function
1	0...255	Rotation (pan) (0° up to the maximum value of the Pan range of 540°)
2	0...255	Inclination (tilt) (0° up to the maximum value of the Tilt range of 180°)
3	0...255	Master dimmer 0 – 100%

7.5 Functions in 8-channel DMX mode (16-bit)

Channel	Value	Function
1	0...255	Rotation (pan) (0° up to the maximum value of the Pan range of 540°)
2	0...255	Fine adjustment rotation (pan)
3	0...255	Inclination (tilt) (0° up to the maximum value of the Tilt range of 180°)
4	0...255	Fine adjustment inclination (tilt)

Channel	Value	Function	
5	0...255	Motor speed (fast to slow)	
6	0...255	Master dimmer 0 – 100%	
7	0...255	000...049	No function
		050...059	Red
		060...069	Green
		070...079	Blue
		080...089	White
		090...099	Yellow
		100...109	Cyan
		110...119	Purple
		120...129	All White
		130...139	Empty
140...149	Programme 1		

Channel	Value	Function	
		150...159	Programme 2
		160...169	Programme 3
		170...179	Programme 4
		180...189	Programme 5
		190...199	Programme 6
		200...209	Programme 7
		210...219	Programme 8
		220...229	Programme 9
		230...233	Empty
		234...236	Reset
		237...249	Empty
	250...255	Sound-controlled mode	
8	0...255	Speed / Sensitivity	

7.6 Functions in 13-channel DMX mode (16-bit)

Channel	Value	Function	
1	0...255	Rotation (pan) (0° up to the maximum value of the Pan range of 540°)	
2	0...255	Fine adjustment rotation (pan)	
3	0...255	Inclination (tilt) (0° up to the maximum value of the Tilt range of 180°)	
4	0...255	Fine adjustment inclination (tilt)	
5	0...255	Motor speed (fast to slow)	
6	0...255	Master dimmer 0 – 100%	
7	0...255	000...009	No function (open)
		010...255	Strobe, slow to fast (1 Hz – 25 Hz)
8	0...255	Red	Dimmer 0 – 100%
9	0...255	Green	Dimmer 0 – 100%
10	0...255	Blue	Dimmer 0 – 100%

Channel	Value	Function	
11	0...255	White	Dimmer 0 – 100%
12	0...255	000...049	No function
		050...059	Red
		060...069	Green
		070...079	Blue
		080...089	White
		090...099	Yellow
		100...109	Cyan
		110...119	Purple
		120...129	All White
		130...139	Empty
		140...149	Programme 1
		150...159	Programme 2

Channel	Value	Function	
		160...169	Programme 3
		170...179	Programme 4
		180...189	Programme 5
		190...199	Programme 6
		200...209	Programme 7
		210...219	Programme 8
		220...229	Programme 9
		230...233	Empty
		234...236	Reset
		237...249	Empty
		250...255	Sound-controlled mode
13	0...255	Speed / Sensitivity	

7.7 Functions in 25-channel DMX mode (16-bit)

Channel	Value	Function		
1	0...255	Rotation (pan) (0° up to the maximum value of the Pan range of 540°)		
2	0...255	Fine adjustment rotation (pan)		
3	0...255	Inclination (tilt) (0° up to the maximum value of the Tilt range of 180°)		
4	0...255	Fine adjustment inclination (tilt)		
5	0...255	Motor speed (fast to slow)		
6	0...255	Master dimmer 0 – 100%		
7	0...255	000...009		No function (open)
		010...255		Strobe, slow to fast (1 Hz – 25 Hz)
8	0...255	LED 1	Red	Dimmer 0 – 100%
9	0...255	LED 1	Green	Dimmer 0 – 100%
10	0...255	LED 1	Blue	Dimmer 0 – 100%

Channel	Value	Function		
11	0...255	LED 1	White	Dimmer 0 – 100%
12	0...255	LED 2	Red	Dimmer 0 – 100%
13	0...255	LED 2	Green	Dimmer 0 – 100%
14	0...255	LED 2	Blue	Dimmer 0 – 100%
15	0...255	LED 2	White	Dimmer 0 – 100%
16	0...255	LED 3	Red	Dimmer 0 – 100%
17	0...255	LED 3	Green	Dimmer 0 – 100%
18	0...255	LED 3	Blue	Dimmer 0 – 100%
19	0...255	LED 3	White	Dimmer 0 – 100%
20	0...255	LED 4	Red	Dimmer 0 – 100%
21	0...255	LED 4	Green	Dimmer 0 – 100%
22	0...255	LED 4	Blue	Dimmer 0 – 100%
23	0...255	LED 4	White	Dimmer 0 – 100%

Channel	Value	Function	
24	0...255	000...049	No function
		050...059	Red
		060...069	Green
		070...079	Blue
		080...089	White
		090...099	Yellow
		100...109	Cyan
		110...119	Purple
		120...129	All White
		130...139	Empty
		140...149	Programme 1
		150...159	Programme 2
160...169	Programme 3		

Channel	Value	Function	
		170...179	Programme 4
		180...189	Programme 5
		190...199	Programme 6
		200...209	Programme 7
		210...219	Programme 8
		220...229	Programme 9
		230...233	Empty
		234...236	Reset
		237...249	Empty
		250...255	Sound-controlled mode
25	0...255	Speed / Sensitivity	

8 Remote control

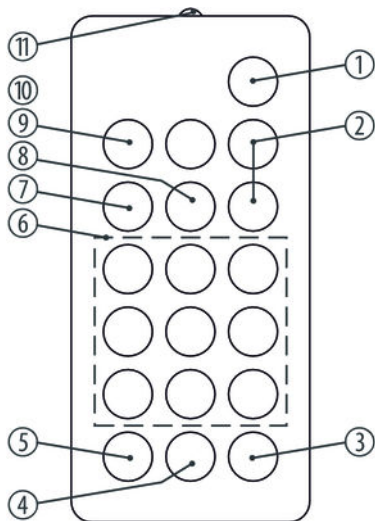

To use the remote control, point it with the infrared diode to the infrared sensor on the unit and press the desired buttons. The maximum distance from the unit is about 9 m. The device will only respond to the remote control signals if it is not controlled via DMX.

1 [STAND BY]

Stops the automatic mode and blackouts the unit. The display shows 'Stop'. In this mode, the device responds to the remote control.

2 [Dimmer + / -]

Adjusts the light intensity between 0 and 100%. Press repeatedly [Dimmer +] or keep the button pressed to increase the light intensity. Press repeatedly [Dimmer -] or keep the button pressed to decrease the light intensity.

3 [SOUND OFF]

Deactivates the sound-control.

4	<i>[SHOW]</i>		
	To call one of the 9 preprogrammed automatic shows, press this button followed by the number button 1 – 9 for the desired show. To cancel a show, press <i>[STAND BY]</i> .		
5	<i>[SOUND ON]</i>		
	Activates the 'Sound Control' mode.		
6	Number buttons		
	These buttons allow you to trim the rotation (X) and tilt (Y) of the device head:		
	Button 1: X- & Y+	Button 4: X-	Button 7: X- & Y-
	Button 2: Y+	Button 5: Centre	Button 8: Y-
	Button 3: X+ & Y+	Button 6: X+	Button 9: X+ & Y-
7	<i>[STROBE]</i>		
	Enables the Strobe function for the current light scene. Then press one of the number buttons 2 – 9 for the desired strobe frequency. Press number button 1 to turn the strobe function off.		

8	<i>[COLOR]</i> To call various light scenes. Then press one of the number buttons 1 – 8 for the desired light scene.
9	<i>[FULL ON]</i> Press this button to call the light scene 'FULL ON' (= white light with full intensity).
10	<i>[GOBO]</i> No function.
11	Infrared diode Sends the infrared signals to the device.

9 Technical specifications

Number of DMX channels	3, 8, 13, 25
LED	4 × 10 W Quad Colour RGBW LEDs
Beam angle	28°
Voltage supply	AC 100 – 240 V ~ , 50/60 Hz
Power consumption	55 W (Full on)
Fuse	5 mm × 20 mm, 2 A, 250 V, fast-acting
Dimensions (W × H × D), when light beam pointing upwards	162 mm × 228 mm × 174 mm
Weight	2.8 kg

10 Plug and connection assignments

Introduction

This chapter will help you select the right cables and plugs to connect your valuable equipment so that a perfect light experience is guaranteed.

Please take our tips, because especially in 'Sound & Light' caution is indicated: Even if a plug fits into a socket, the result of an incorrect connection may be a destroyed DMX controller, a short circuit or 'just' a not working light show!

DMX connections



The unit offers a 3-pin XLR socket for DMX output and a 3-pin XLR plug for DMX input. Please refer to the drawing and table below for the pin assignment of a suitable XLR plug.

Pin	Configuration
1	Ground, shielding
2	Signal inverted (DMX-, 'cold signal')
3	Signal (DMX+, 'hot signal')

11 Troubleshooting



NOTICE!

Possible data transmission errors

For error-free operation make use of dedicated DMX cables and do not use ordinary microphone cables.

Never connect the DMX input or output to audio devices such as mixers or amplifiers.

In the following we list a few common problems that may occur during operation. We give you some suggestions for easy troubleshooting:

Symptom	Remedy
The unit does not work, no light, the fan does not run	Check the mains connection and the main fuse.
No response to the DMX controller	1. Check the DMX connectors and cables for proper connection.
	2. Check the address settings and the DMX polarity.
	3. Try using another DMX controller.
	4. Check to see if the DMX cables run near or alongside to high voltage cables that may cause damage or interference to DMX interface circuits.

If the procedures recommended above do not succeed, please contact our Service Center. You can find the contact information at www.thomann.de.

12 Cleaning

Optical lenses

Clean the optical lenses, that are accessible from the outside, regularly in order to optimize the light output. The frequency of cleaning depends on the operating environment: wet, smoky or particularly dirty surroundings can cause more accumulation of dirt on the optics of the device.

- Clean with a soft cloth using our lamp and lens cleaner (item no. 280122).
- Always dry the parts carefully.

Fan grids

The fan grids of the device must be cleaned on a regular basis to remove dust and dirt. Before cleaning, switch off the device and disconnect AC-powered devices from the mains. Use a lint-free damp cloth for cleaning. Never use solvents or alcohol for cleaning.

13 Protecting the environment

Disposal of the packaging material



For the transport and protective packaging, environmentally friendly materials have been chosen that can be supplied to normal recycling.

Ensure that plastic bags, packaging, etc. are properly disposed of.

Do not just dispose of these materials with your normal household waste, but make sure that they are fed to a recovery. Please follow the notes and markings on the packaging.

Disposal of batteries



Batteries must not be disposed of as domestic waste or thrown into fire. Dispose of the batteries according to national or local regulations regarding hazardous waste. To protect the environment, dispose of empty batteries at your retail store or at appropriate collection sites.

Disposal of your old device



This product is subject to the European Waste Electrical and Electronic Equipment Directive (WEEE). Do not dispose with your normal household waste.

Dispose this device through an approved waste disposal firm or through your local waste facility. When discarding the device, comply with the rules and regulations that apply in your country. If in doubt, consult your local waste disposal facility.



