



  
STAIRVILLE

Blade Sting 8  
RGBW Beam Mover  
moving head

Musikhaus Thomann  
Thomann GmbH  
Hans-Thomann-Straße 1  
96138 Burgebrach  
Deutschland  
Telephone: +49 (0) 9546 9223-0  
E-mail: [info@thomann.de](mailto:info@thomann.de)  
Internet: [www.thomann.de](http://www.thomann.de)

20.07.2017, ID: 375688 (V2)

# Table of contents

|          |   |           |
|----------|---|-----------|
| <b>1</b> | <b>General notes</b> .....                | <b>5</b>  |
|          | 1.1 Further information.....              | 6         |
|          | 1.2 Notational conventions.....           | 7         |
|          | 1.3 Symbols and signal words.....         | 7         |
| <b>2</b> | <b>Safety instructions</b> .....          | <b>10</b> |
| <b>3</b> | <b>Features</b> .....                     | <b>17</b> |
| <b>4</b> | <b>Installation and starting up</b> ..... | <b>18</b> |
| <b>5</b> | <b>Connections and controls</b> .....     | <b>24</b> |
| <b>6</b> | <b>Operating</b> .....                    | <b>30</b> |
|          | 6.1 Operating modes.....                  | 31        |
|          | 6.2 System settings.....                  | 35        |
|          | 6.3 Menu overview.....                    | 38        |
|          | 6.4 Functions in 12-channel DMX mode..... | 41        |
|          | 6.5 Functions in 16-channel DMX mode..... | 43        |
|          | 6.6 Functions in 40-channel DMX mode..... | 46        |

|           |   |           |
|-----------|---|-----------|
| 6.7       | Functions in 44-channel DMX mode.....       | 50        |
| <b>7</b>  | <b>Technical specifications.....</b>        | <b>55</b> |
| <b>8</b>  | <b>Plug and connection assignments.....</b> | <b>57</b> |
| <b>9</b>  | <b>Troubleshooting.....</b>                 | <b>58</b> |
| <b>10</b> | <b>Cleaning.....</b>                        | <b>60</b> |
| <b>11</b> | <b>Protecting the environment.....</b>      | <b>61</b> |

# 1 General notes

This manual contains important instructions for the safe operation of the unit. Read and follow the safety instructions and all other instructions. Keep the manual for future reference. Make sure that it is available to all those using the device. If you sell the unit please make sure that the buyer also receives this manual.

Our products are subject to a process of continuous development. Thus, they are subject to change.

## 1.1 Further information

On our website ([www.thomann.de](http://www.thomann.de)) you will find lots of further information and details on the following points:

|                       |   |
|-----------------------|---|
| Download              | This manual is also available as PDF file for you to download.                                    |
| Keyword search        | Use the search function in the electronic version to find the topics of interest for you quickly. |
| Online guides         | Our online guides provide detailed information on technical basics and terms.                     |
| Personal consultation | For personal consultation please contact our technical hotline.                                   |
| Service               | If you have any problems with the device the customer service will gladly assist you.             |

## 1.2 Notational conventions

This manual uses the following notational conventions:

### Letterings

The letterings for connectors and controls are marked by square brackets and italics.

**Examples:** *[VOLUME]* control, *[Mono]* button.

### Displays

Texts and values displayed on the device are marked by quotation marks and italics.



**Examples:** *'24ch'*, *'OFF'*.

## 1.3 Symbols and signal words

In this section you will find an overview of the meaning of symbols and signal words that are used in this manual.

| Signal word   | Meaning  |
|---|--|
| <b>DANGER!</b>  | This combination of symbol and signal word indicates an immediate dangerous situation that will result in death or serious injury if it is not avoided.        |
| <b>WARNING!</b>   | This combination of symbol and signal word indicates a possible dangerous situation that can result in death or serious injury if it is not avoided.           |
| <b>CAUTION!</b>   | This combination of symbol and signal word indicates a possible dangerous situation that can result in minor injury if it is not avoided.                      |
| <b>NOTICE!</b>  | This combination of symbol and signal word indicates a possible dangerous situation that can result in material and environmental damage if it is not avoided. |
| Warning signs   | Type of danger   |
|  | Warning – high-voltage.  |



| Warning signs   | Type of danger                   |
|---|----------------------------------|
|  | <p>Warning – suspended load.</p> |
|  | <p>Warning – danger zone.</p>    |

## 2 Safety instructions

### **Intended use**

This device is intended to be used as moving-head spotlight. The device is designed for professional use and is not suitable for use in households. Use the device only as described in this user manual. Any other use or use under other operating conditions is considered to be improper and may result in personal injury or property damage. No liability will be assumed for damages resulting from improper use.

This device may be used only by persons with sufficient physical, sensorial, and intellectual abilities and having corresponding knowledge and experience. Other persons may use this device only if they are supervised or instructed by a person who is responsible for their safety.

**Safety****DANGER!****Danger for children**

Ensure that plastic bags, packaging, etc. are disposed of properly and are not within reach of babies and young children. Choking hazard!

Ensure that children do not detach any small parts (e.g. knobs or the like) from the unit. They could swallow the pieces and choke!

Never let children unattended use electrical devices.

**DANGER!****Electric shock caused by high voltages inside**

Within the device there are areas where high voltages may be present. Never remove any covers.

There are no user-serviceable parts inside.

Do not use the device if covers, protectors or optical components are missing or damaged.



### **DANGER!**

#### **Electric shock caused by short-circuit**

Always use proper ready-made insulated mains cabling (power cord) with a protective contact plug. Do not modify the mains cable or the plug. Failure to do so could result in electric shock/death or fire. If in doubt, seek advice from a registered electrician.



### **WARNING!**

#### **Eye damage caused by high light intensity**

Never look directly into the light source.



### **WARNING!**

#### **Risk of epileptic shock**

Strobe lighting can trigger seizures in photosensitive epilepsy. Sensitive persons should avoid looking at strobe lights.



**WARNING!**

**Risk of injury caused by falling objects**

Make sure that the installation complies with the standards and rules that apply in your country. Always secure the device with a secondary safety attachment, such as a safety cable or a safety chain.

The load capacity of trusses or other fixtures must be sufficient for the intended number of devices. Note that the movement of the head places additional loads on the load-bearing parts.



### **CAUTION!**

#### **Risk of injury due to movements of the device**

The head of the device can move quickly (pan, tilt) and can produce very bright light. This is also valid immediately after you turn on the device, when the device operates in automatic mode or under remote control and when you turn off a DMX controller that is connected to the device. Persons staying near the device could be injured or frightened.

Before you turn on the device and during the operation, always ensure that nobody stays close to the device. If work has to be performed in the area of movement or in the near vicinity of the device, it must remain turned off.



### **NOTICE!**

#### **Risk of fire**

Do not block areas of ventilation. Do not install the device near any direct heat source. Keep the device away from naked flames.



**NOTICE!**

**Operating conditions**

This device has been designed for indoor use only. To prevent damage, never expose the device to any liquid or moisture. Avoid direct sunlight, heavy dirt, and strong vibrations.

The device must not be moved while it is in use.



**NOTICE!**

**Power supply**

Before connecting the device, ensure that the input voltage (AC outlet) matches the voltage rating of the device and that the AC outlet is protected by a residual current circuit breaker. Failure to do so could result in damage to the device and possibly injure the user.

Unplug the device before electrical storms occur and when it is unused for long periods of time to reduce the risk of electric shock or fire.



### **NOTICE!**

#### **Possible staining**

The plasticiser contained in the rubber feet of this product may possibly react with the coating of your parquet, linoleum, laminate or PVC floor and after some time cause permanent dark stains.

In case of doubt, do not put the rubber feet directly on the floor, but use felt-pad floor protectors or a carpet.



### 3 Features

- 8 × 4-in-1 quad colour LEDs (RGBW, 10 watt each)
- narrow beam angle (approx. 2 degree/lens)
- adjustable PAN and TILT area
- Control via DMX (4 different modes) and buttons and display on the unit
- 6 preprogrammed automatic shows
- Sound control
- Stand alone mode
- Master/Slave mode
- Lockable connectors (Power Twist) for self-supply and for supplying further devices
- Suitable for wall/traverse mounting
- Power supply cable (Power Twist) and Omega brackets included

## 4 Installation and starting up

Unpack and carefully check that there is no transportation damage before using the unit. Keep the equipment packaging. To fully protect the device against vibration, dust and moisture during transportation or storage use the original packaging or your own packaging material suitable for transport or storage, respectively.

Lift the device only at the base. When lifted at the rotatable mounting, the device may be damaged.

You can install the device standing or hanging. When in use, the device must be mounted at a solid surface or clamped to an approved truss.

Work from a stable platform whenever you install or move the device or when you perform any kind of maintenance. Block access under the work area.



**WARNING!**

**Risk of injury caused by falling objects**

Make sure that the installation complies with the standards and rules that apply in your country. Always secure the device with a secondary safety attachment, such as a safety cable or a safety chain.

The load capacity of trusses or other fixtures must be sufficient for the intended number of devices. Note that the movement of the head places additional loads on the load-bearing parts.



### **CAUTION!**

#### **Risk of injury due to movements of the device**

The head of the device can move quickly (pan, tilt) and can produce very bright light. This is also valid immediately after you turn on the device, when the device operates in automatic mode or under remote control and when you turn off a DMX controller that is connected to the device. Persons staying near the device could be injured or frightened.

Before you turn on the device and during the operation, always ensure that nobody stays close to the device. If work has to be performed in the area of movement or in the near vicinity of the device, it must remain turned off.



### **NOTICE!**

#### **Possible damage caused by movements of the device**

Always ensure that enough space is free around the device for the movements of the head (pan, tilt).



**NOTICE!**

**Possible data transmission errors**

For error-free operation make use of dedicated DMX cables and do not use ordinary microphone cables.

Never connect the DMX input or output to audio devices such as mixers or amplifiers.

### Mounting options

The quick-release holes on the bottom are used to secure wall or truss mounting of the device using omega brackets. Additionally secure the device by a safety-rope against falling.

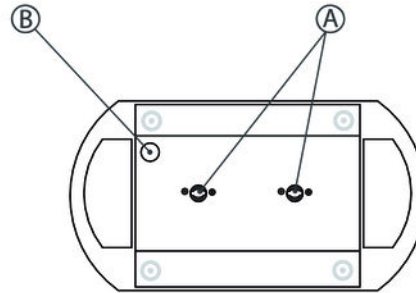

|   |  |
|---|--|
| A | Quick-release hole for attaching Omega brackets. |
|---|--|

|   |                   |
|---|-------------------|
| B | Safety-rope hole. |
|---|-------------------|

Create all connections while the device is off. Use the shortest possible high-quality cables for all connections. Take care when running the cables to prevent tripping hazards.

**Connections in DMX mode**

Connect the DMX input of the device to the DMX output of a DMX controller or another DMX device. Connect the output of the first DMX device to the input of the second one, and so on to form a daisy chain. Always ensure that the output of the last DMX device in the daisy chain is terminated with a resistor ( $110\ \Omega$ ,  $\frac{1}{4}\ \text{W}$ ).

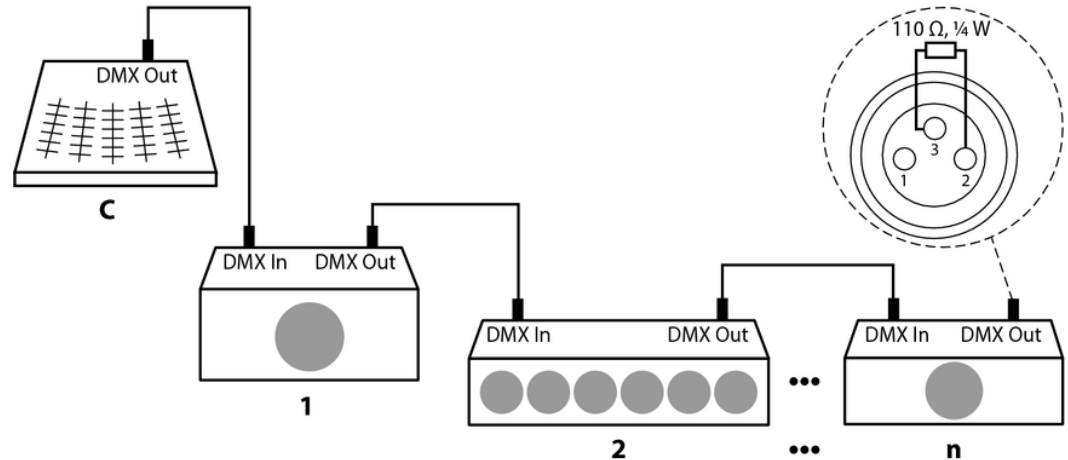

## 5 Connections and controls

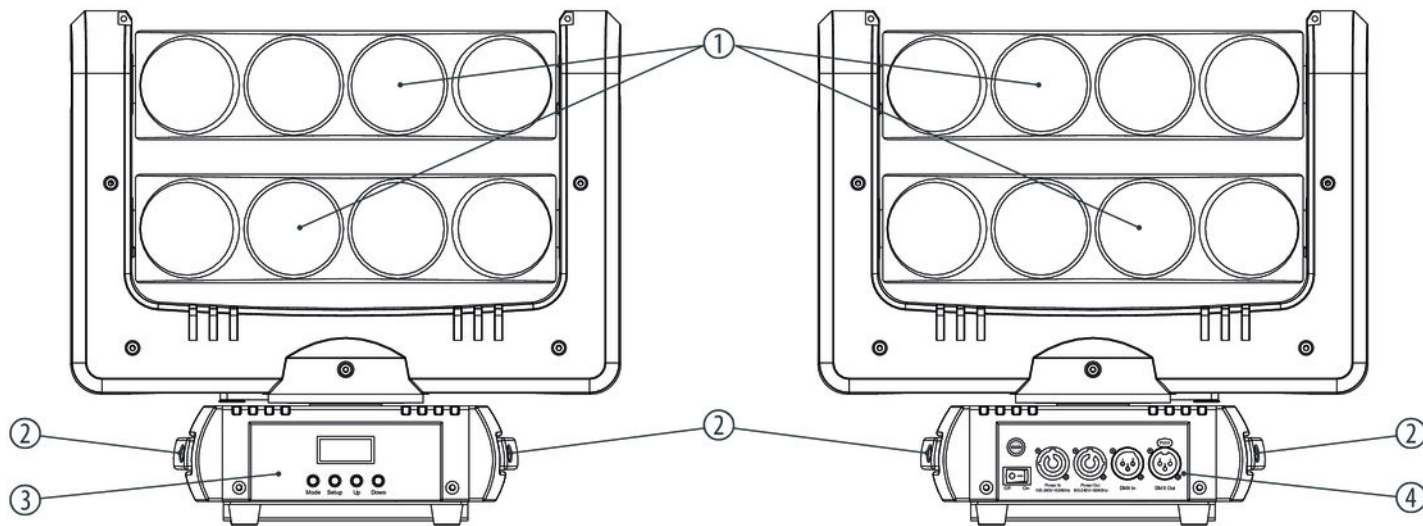



|   |   |
|---|---|
| 1 | 8 × LED RGBW.   |
| 2 | Grab handle   |
| 3 | Operating panel with display.   |
| 4 | Connector panel with main switch, voltage supply and DMX connections. |

## Operating panel with display

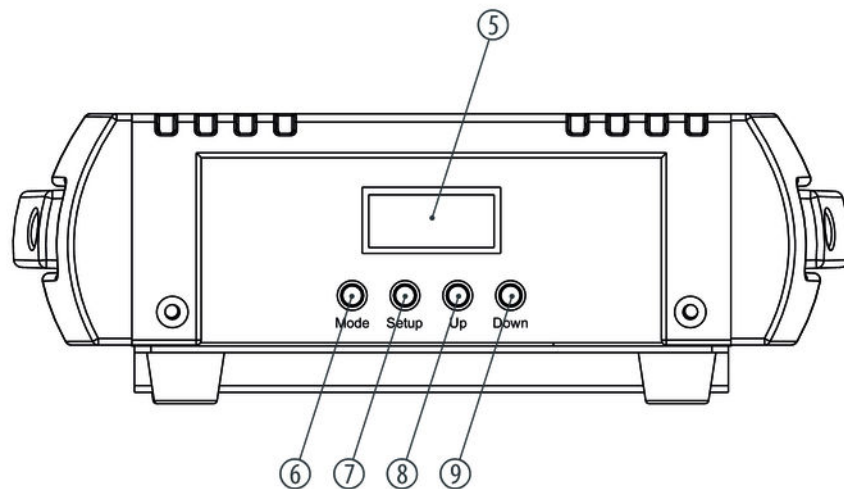

|   |  |
|---|--|
| 5 | Display  |
| 6 | <i>[Mode]</i><br>Activates the main menu and toggles between menu items. Closes an opened submenu. |
| 7 | <i>[Setup]</i><br>Selects an option of the respective operating mode, confirms the set value.      |
| 8 | <i>[Up]</i><br>Increases the displayed value by one.   |
| 9 | <i>[Down]</i><br>Decreases the displayed value by one.   |

**Connector panel with main switch, voltage supply and DMX connections**

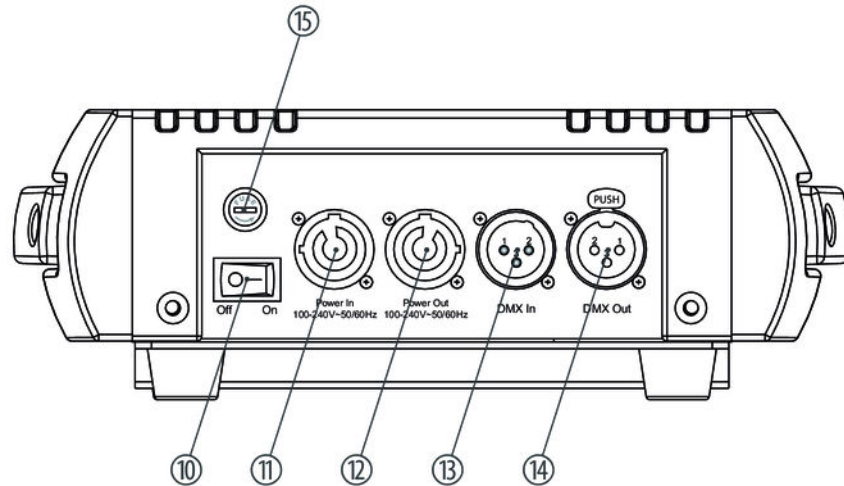

|    |   |
|----|---|
| 10 | <i>[ON   OFF]</i><br>Main switch to turn the device on and off.                     |
| 11 | <i>[Power In]</i><br>Lockable input socket (Power Twist) for power supply.          |
| 12 | <i>[Power Out]</i><br>Lockable output socket (Power Twist) to supply further units. |
| 13 | <i>[DMX In]</i><br>DMX input  |
| 14 | <i>[DMX Out]</i><br>DMX output  |
| 15 | Fuse holder   |

## 6 Operating

Connect the device to the power supply to start operation. After a few seconds, the display indicates that a reset is in progress. At the same time, all axes are moved to the respective starting position. The device is then ready for use.

Press repeatedly *[Mode]* or *[Up]* or *[Down]* to select an operating mode:

- AUTO
- SHOW
- SOUND
- DMX
- SLAVE

If you don't press any button for about seven seconds the display turns off.

## 6.1 Operating modes

### AUTO

Automatic operation can only be activated when the unit is operating alone or as master in a master / slave combination. This setting is only relevant if the device is not controlled via DMX.

Press repeatedly *[Mode]* or *[Up]* or *[Down]* until the display shows 'AUTO'. Automatic operation starts immediately with the last used settings.

### Setting options in AUTO mode

Several auto operation parameters can be adjusted in the 'Auto' menu. Switch to operating mode AUTO and use *[Setup]* to open the related menu.

Repeatedly press *[Setup]* to successively call various menu options. When the display shows the desired option (mode), the related value can be adjusted using *[Up]* or *[Down]*.

With *[Setup]* you get to the next menu level. With *[Mode]* you return to the previous menu level.

| Parameter / mode | Function  |
|------------------|---|
| LED / Auto       | Colour selection and dimmer settings follow the preprogrammed show programmes, moving speed ( <i>'Speed'</i> ) and flash frequency for strobe effect ( <i>'Freq.'</i> ) are adjustable. |
| LED / Color      | Solid colour selection ( <i>'Static'</i> ) and flash frequency setting for strobe effect ( <i>'Freq.'</i> ).  |
| LED / Dimmer     | Dimmer setting ( <i>'Dimmer'</i> ) and flash frequency setting for strobe effect ( <i>'Freq.'</i> ).  |
| Pan / p-Auto     | Rotation follows preprogrammed show programmes.   |
| Pan / p-Manual   | Rotation stops in the predefined angle position.  |
| Pan / p-CW       | Clockwise rotation, speed adjustable ( <i>'Speed 1 ... 16'</i> ).   |
| Pan / p-CCW      | Counter-clockwise rotation, speed adjustable ( <i>'Speed 1 ... 16'</i> ).   |
| Tilt1 / p-Auto   | Tilting motion follows preprogrammed show programmes.   |
| Tilt1 / p-Manual | Tilting motion stops in the predefined angle position.  |



| Parameter / mode | Function   |
|------------------|--|
| Tilt2 / p-Auto   | Tilting motion follows preprogrammed show programmes.  |
| Tilt2 / p-Manual | Tilting motion stops in the predefined angle position. |

## SHOW

A preprogrammed automatic show can only be activated when the unit is operating alone or as master in a master / slave combination. This setting is only relevant if the device is not controlled via DMX.

Press repeatedly *[Mode]* or *[Up]* or *[Down]* until the display shows 'SHOW'.

Press *[Setup]* and use *[Up]* and *[Down]* to select one of the preprogrammed automatic shows 'Show1' ... 'Show6'.

## SOUND

Sound control can only be activated when the unit is operating alone or as master in a master / slave combination. This setting is only relevant if the device is not controlled via DMX.

Press repeatedly *[Mode]* or *[Up]* or *[Down]* until the display shows 'SOUND'.

Press *[Setup]* and use *[Up]* and *[Down]* to adjust the sensitivity for the sound control in a range of 'S: 000' ... 'S: 031'.

### DMX

This setting is only relevant when the device is controlled via DMX.

Press *[Mode]* repeatedly until the display shows 'DMX'. Press *[Setup]*. First use *[Up]* or *[Down]* to highlight the menu item 'Address'.

Use *[Up]* or *[Down]* to specify the desired DMX address in a range from '001' ... '512'.

Use *[Mode]* to return to the parent menu and use *[Up]* or *[Down]* to highlight the menu item 'Channel'. Now you can select one of the following DMX modes:

- '12Chs' (twelve channels)
- '16Chs' (sixteen channels)
- '40Chs' (forty channels)
- '44Chs' (forty-four channels)

Make sure that the setting matches the configuration of your DMX controller. The following table shows the highest possible first DMX address for the various DMX modes.

| Mode       | Highest possible DMX address |
|------------|------------------------------|
| 12-channel | 501                          |
| 16-channel | 497                          |
| 40-channel | 473                          |
| 44-channel | 469                          |

## SLAVE

This setting is only relevant if the device is working as Slave in a Master / Slave configuration and is not controlled via DMX. To activate the operating mode, repeatedly press *[Mode]* or *[Up]* or *[Down]* until the display shows 'SLAVE'.

To quit the operating mode, press again *[Mode]*, *[Up]* or *[Down]*.

## 6.2 System settings

In 'SETTINGS' menu, you can customise several device parameters.

To open the menu press *[Mode]* or *[Up]* or *[Down]* repeatedly, until the display shows 'SETTINGS' and confirm with *[Setup]*.

Use *[Up]* and *[Down]* to select the desired menu item and confirm with *[Setup]*. Change the displayed value with *[Up]* or *[Down]*.

With *[Mode]* you return to the previous menu level.

| Parameter / mode | Function  |
|------------------|---|
| BL Time Option   | Duration display backlight: '5s', '10s', '20s', '30s' or 'on'.  |
| Adjust           | Fine adjustment of the three movement axis: 'Pan', 'Tilt1' and 'Tilt2'.   |
| Reset            | Reset of all device settings. When resetting to factory defaults, the display shows 'Factory Reset ...'.  |
| Power            | Display of the supply and motor voltage of the device.  |
| Error            | Display of error messages from the self-test. When there is no error message present, the display shows the value '000000'. With <i>[Setup]</i> error codes can be displayed. |
| Lam              | LED status information query.   |

| Parameter / mode | Function   |
|------------------|--|
| Use              | LED uptime query. With <i>[Setup]</i> the value can be reset. The display shows the safety prompt 'Clear Y/N?'.  |
| Sensor           | Movement axis query: 'P-Hall', 'T1-Hall' and 'T2-Hall'. Upon deviation, 'Hall not good' is displayed for the respective axis.<br><br>Via parameters 'p-Rast', 't1-Ras' and 't2-Ras' you can enable or disable the axis stop at position 90 degree, 180 degree, 360 degree or 540 degree. |
| About            | General device data query. With <i>[Setup]</i> the information menu to call available data is opened.  |
| X Angle          | Definition of rotation movement axis stop position: 'Pan 180', 'Pan 360' or 'Pan 540'.   |
| Y1 Angle         | Definition of tilting movement axis stop position: 'Tilt1 90' or 'Tilt1 180'.  |
| Y2 Angle         | Definition of tilting movement axis stop position: 'Tilt2 90' or 'Tilt2 180'.  |

## 6.3 Menu overview

### Menu AUTO

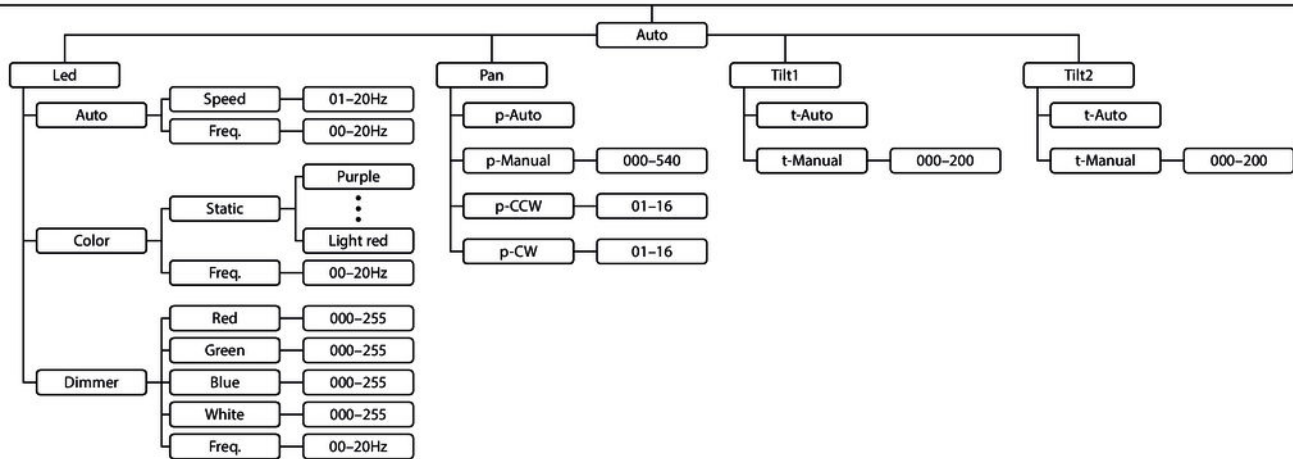

**Menus SHOW, SOUND, DMX,  
SLAVE**

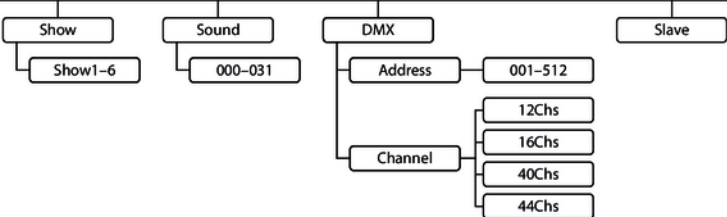

## Menu SETTINGS

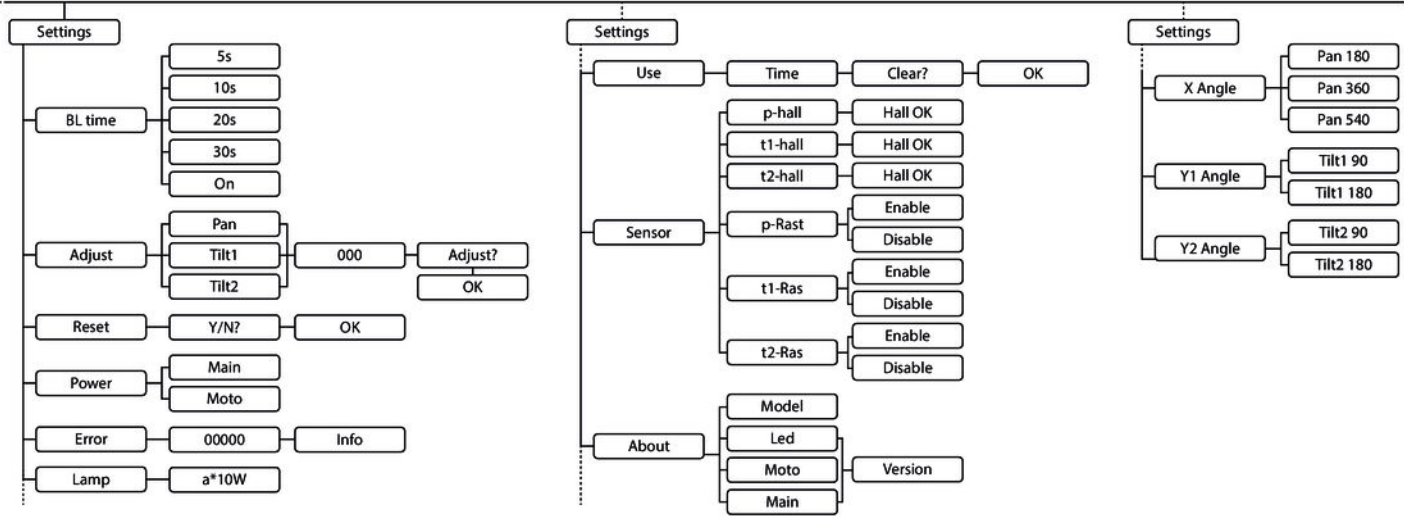



## 6.4 Functions in 12-channel DMX mode

| Channel | Value     | Function   |
|---------|-----------|--|
| 1       | 0 ... 255 | Rotation movement, 0° ... 180° / 360° / 540°                   |
| 2       | 0 ... 255 | Fine adjustment rotation position                              |
| 3       | 0 ... 255 | Tilting movement 1 (upper LED row), 0° ... 90° / 180°          |
| 4       | 0 ... 255 | Fine adjustment tilting position 1 (upper LED row)             |
| 5       | 0 ... 255 | Tilting movement 2 (lower LED row), 0° ... 90° / 180°          |
| 6       | 0 ... 255 | Fine adjustment tilting position 2 (lower LED row)             |
| 7       | 0 ... 255 | Movement speed rotation and tilting movement, increasing speed |

| Channel | Value       | Function  |
|---------|-------------|---|
| 8       | 0 ... 129   | No function.  |
|         | 130 ... 192 | Clockwise rotation movement, speed increasing         |
|         | 193 ... 255 | Counter-clockwise rotation movement, speed increasing |
| 9       | 0 ... 255   | Intensity red LED (0 % ... 100 %)                     |
| 10      | 0 ... 255   | Intensity green LED (0 % ... 100 %)                   |
| 11      | 0 ... 255   | Intensity blue LED (0 % ... 100 %)                    |
| 12      | 0 ... 255   | Intensity white LED (0 % ... 100 %)                   |

## 6.5 Functions in 16-channel DMX mode

| Channel | Value       | Function   |
|---------|-------------|--|
| 1       | 0 ... 255   | Rotation movement, 0° ... 180° / 360° / 540°                   |
| 2       | 0 ... 255   | Fine adjustment rotation position                              |
| 3       | 0 ... 255   | Tilting movement 1 (upper LED row), 0° ... 90° / 180°          |
| 4       | 0 ... 255   | Fine adjustment tilting position 1 (upper LED row)             |
| 5       | 0 ... 255   | Tilting movement 2 (lower LED row), 0° ... 90° / 180°          |
| 6       | 0 ... 255   | Fine adjustment tilting position 2 (lower LED row)             |
| 7       | 0 ... 255   | Movement speed rotation and tilting movement, increasing speed |
| 8       | 0 ... 129   | No function.   |
|         | 130 ... 192 | Clockwise rotation movement, speed increasing                  |
|         | 193 ... 255 | Counter-clockwise rotation movement, speed increasing          |

| Channel | Value     | Function                            |
|---------|-----------|-------------------------------------|
| 9       | 0 ... 255 | Dimmer function, all LEDs           |
| 10      | 0 ... 255 | Intensity red LED (0 % ... 100 %)   |
| 11      | 0 ... 255 | Intensity green LED (0 % ... 100 %) |
| 12      | 0 ... 255 | Intensity blue LED (0 % ... 100 %)  |
| 13      | 0 ... 255 | Intensity white LED (0 % ... 100 %) |

| Channel | Value       | Function  |
|---------|-------------|---|
| 14      | 0 ... 9     | No function.  |
|         | 10 ... 19   | Auto operation  |
|         | 20 ... 29   | Preprogrammed automatic show no. 01                           |
|         | 30 ... 39   | Preprogrammed automatic show no. 02                           |
|         | 40 ... 49   | Preprogrammed automatic show no. 03                           |
|         | 50 ... 59   | Preprogrammed automatic show no. 04                           |
|         | 60 ... 69   | Preprogrammed automatic show no. 05                           |
|         | 70 ... 79   | Preprogrammed automatic show no. 06                           |
|         | 80 ... 129  | No function   |
|         | 130 ... 255 | Sound-controlled operation, increasing sensitivity            |
| 15      | 0 ... 255   | Chaser light speed, auto operation, if channel 14 = 10 ... 19 |
| 16      | 0 ... 14    | No function   |
|         | 15 ... 255  | Flash frequency, if channel 14 = 0 ... 9                      |

## 6.6 Functions in 40-channel DMX mode

| Channel | Value       | Function   |
|---------|-------------|--|
| 1       | 0 ... 255   | Rotation movement, 0° ... 180° / 360° / 540°                   |
| 2       | 0 ... 255   | Fine adjustment rotation position                              |
| 3       | 0 ... 255   | Tilting movement 1 (upper LED row), 0° ... 90° / 180°          |
| 4       | 0 ... 255   | Fine adjustment tilting position 1 (upper LED row)             |
| 5       | 0 ... 255   | Tilting movement 2 (lower LED row), 0° ... 90° / 180°          |
| 6       | 0 ... 255   | Fine adjustment tilting position 2 (lower LED row)             |
| 7       | 0 ... 255   | Movement speed rotation and tilting movement, increasing speed |
| 8       | 0 ... 129   | No function.   |
|         | 130 ... 192 | Clockwise rotation movement, speed increasing                  |
|         | 193 ... 255 | Counter-clockwise rotation movement, speed increasing          |

| Channel | Value     | Function                             |
|---------|-----------|--------------------------------------|
| 9       | 0 ... 255 | Intensity red LED1 (0 % ... 100 %)   |
| 10      | 0 ... 255 | Intensity green LED1 (0 % ... 100 %) |
| 11      | 0 ... 255 | Intensity blue LED1 (0 % ... 100 %)  |
| 12      | 0 ... 255 | Intensity white LED1 (0 % ... 100 %) |
| 13      | 0 ... 255 | Intensity red LED2 (0 % ... 100 %)   |
| 14      | 0 ... 255 | Intensity green LED2 (0 % ... 100 %) |
| 15      | 0 ... 255 | Intensity blue LED2 (0 % ... 100 %)  |
| 16      | 0 ... 255 | Intensity white LED2 (0 % ... 100 %) |
| 17      | 0 ... 255 | Intensity red LED3 (0 % ... 100 %)   |
| 18      | 0 ... 255 | Intensity green LED3 (0 % ... 100 %) |
| 19      | 0 ... 255 | Intensity blue LED3 (0 % ... 100 %)  |
| 20      | 0 ... 255 | Intensity white LED3 (0 % ... 100 %) |

| Channel | Value     | Function                             |
|---------|-----------|--------------------------------------|
| 21      | 0 ... 255 | Intensity red LED4 (0 % ... 100 %)   |
| 22      | 0 ... 255 | Intensity green LED4 (0 % ... 100 %) |
| 23      | 0 ... 255 | Intensity blue LED4 (0 % ... 100 %)  |
| 24      | 0 ... 255 | Intensity white LED4 (0 % ... 100 %) |
| 25      | 0 ... 255 | Intensity red LED5 (0 % ... 100 %)   |
| 26      | 0 ... 255 | Intensity green LED5 (0 % ... 100 %) |
| 27      | 0 ... 255 | Intensity blue LED5 (0 % ... 100 %)  |
| 28      | 0 ... 255 | Intensity white LED5 (0 % ... 100 %) |
| 29      | 0 ... 255 | Intensity red LED6 (0 % ... 100 %)   |
| 30      | 0 ... 255 | Intensity green LED6 (0 % ... 100 %) |
| 31      | 0 ... 255 | Intensity blue LED6 (0 % ... 100 %)  |
| 32      | 0 ... 255 | Intensity white LED6 (0 % ... 100 %) |



| Channel | Value     | Function                             |
|---------|-----------|--------------------------------------|
| 33      | 0 ... 255 | Intensity red LED7 (0 % ... 100 %)   |
| 34      | 0 ... 255 | Intensity green LED7 (0 % ... 100 %) |
| 35      | 0 ... 255 | Intensity blue LED7 (0 % ... 100 %)  |
| 36      | 0 ... 255 | Intensity white LED7 (0 % ... 100 %) |
| 37      | 0 ... 255 | Intensity red LED8 (0 % ... 100 %)   |
| 38      | 0 ... 255 | Intensity green LED8 (0 % ... 100 %) |
| 39      | 0 ... 255 | Intensity blue LED8 (0 % ... 100 %)  |
| 40      | 0 ... 255 | Intensity white LED8 (0 % ... 100 %) |

## 6.7 Functions in 44-channel DMX mode

| Channel | Value       | Function   |
|---------|-------------|--|
| 1       | 0 ... 255   | Rotation movement, 0° ... 180° / 360° / 540°                   |
| 2       | 0 ... 255   | Fine adjustment rotation position                              |
| 3       | 0 ... 255   | Tilting movement 1 (upper LED row), 0° ... 90° / 180°          |
| 4       | 0 ... 255   | Fine adjustment tilting position 1 (upper LED row)             |
| 5       | 0 ... 255   | Tilting movement 2 (lower LED row), 0° ... 90° / 180°          |
| 6       | 0 ... 255   | Fine adjustment tilting position 2 (lower LED row)             |
| 7       | 0 ... 255   | Movement speed rotation and tilting movement, increasing speed |
| 8       | 0 ... 129   | No function.   |
|         | 130 ... 192 | Clockwise rotation movement, speed increasing                  |
|         | 193 ... 255 | Counter-clockwise rotation movement, speed increasing          |

| Channel | Value     | Function                             |
|---------|-----------|--------------------------------------|
| 9       | 0 ... 255 | Dimmer function, all LEDs            |
| 10      | 0 ... 255 | Intensity red LED1 (0 % ... 100 %)   |
| 11      | 0 ... 255 | Intensity green LED1 (0 % ... 100 %) |
| 12      | 0 ... 255 | Intensity blue LED1 (0 % ... 100 %)  |
| 13      | 0 ... 255 | Intensity white LED1 (0 % ... 100 %) |
| 14      | 0 ... 255 | Intensity red LED2 (0 % ... 100 %)   |
| 15      | 0 ... 255 | Intensity green LED2 (0 % ... 100 %) |
| 16      | 0 ... 255 | Intensity blue LED2 (0 % ... 100 %)  |
| 17      | 0 ... 255 | Intensity white LED2 (0 % ... 100 %) |
| 18      | 0 ... 255 | Intensity red LED3 (0 % ... 100 %)   |
| 19      | 0 ... 255 | Intensity green LED3 (0 % ... 100 %) |
| 20      | 0 ... 255 | Intensity blue LED3 (0 % ... 100 %)  |
| 21      | 0 ... 255 | Intensity white LED3 (0 % ... 100 %) |

| Channel | Value     | Function                             |
|---------|-----------|--------------------------------------|
| 22      | 0 ... 255 | Intensity red LED4 (0 % ... 100 %)   |
| 23      | 0 ... 255 | Intensity green LED4 (0 % ... 100 %) |
| 24      | 0 ... 255 | Intensity blue LED4 (0 % ... 100 %)  |
| 25      | 0 ... 255 | Intensity white LED4 (0 % ... 100 %) |
| 26      | 0 ... 255 | Intensity red LED5 (0 % ... 100 %)   |
| 27      | 0 ... 255 | Intensity green LED5 (0 % ... 100 %) |
| 28      | 0 ... 255 | Intensity blue LED5 (0 % ... 100 %)  |
| 29      | 0 ... 255 | Intensity white LED5 (0 % ... 100 %) |
| 30      | 0 ... 255 | Intensity red LED6 (0 % ... 100 %)   |
| 31      | 0 ... 255 | Intensity green LED6 (0 % ... 100 %) |
| 32      | 0 ... 255 | Intensity blue LED6 (0 % ... 100 %)  |
| 33      | 0 ... 255 | Intensity white LED6 (0 % ... 100 %) |

| Channel | Value     | Function                             |
|---------|-----------|--------------------------------------|
| 34      | 0 ... 255 | Intensity red LED7 (0 % ... 100 %)   |
| 35      | 0 ... 255 | Intensity green LED7 (0 % ... 100 %) |
| 36      | 0 ... 255 | Intensity blue LED7 (0 % ... 100 %)  |
| 37      | 0 ... 255 | Intensity white LED7 (0 % ... 100 %) |
| 38      | 0 ... 255 | Intensity red LED8 (0 % ... 100 %)   |
| 39      | 0 ... 255 | Intensity green LED8 (0 % ... 100 %) |
| 40      | 0 ... 255 | Intensity blue LED8 (0 % ... 100 %)  |
| 41      | 0 ... 255 | Intensity white LED8 (0 % ... 100 %) |

| Channel | Value       | Function   |
|---------|-------------|--|
| 42      | 0 ... 9     | No function.   |
|         | 10 ... 19   | Auto operation   |
|         | 20 ... 29   | Preprogrammed automatic show no. 01                                  |
|         | 30 ... 39   | Preprogrammed automatic show no. 02                                  |
|         | 40 ... 49   | Preprogrammed automatic show no. 03                                  |
|         | 50 ... 59   | Preprogrammed automatic show no. 04                                  |
|         | 60 ... 69   | Preprogrammed automatic show no. 05                                  |
|         | 70 ... 79   | Preprogrammed automatic show no. 06                                  |
|         | 80 ... 129  | No function  |
|         | 130 ... 255 | Sound-controlled operation, increasing sensitivity                   |
| 43      | 0 ... 255   | Chaser light speed, auto operation, if channel 14 = 10 ... 19        |
| 44      | 0 ... 14    | No function  |
|         | 15 ... 255  | Flash frequency auto operation, if channel 42 = 0 ... 9 or 10 ... 19 |

## 7 Technical specifications

|                                 |  |                 |                |
|---------------------------------|--|-----------------|----------------|
| Number of DMX channels          | 12, 16, 40 or 44 channels, according to operating mode |                 |                |
| Illuminant                      | 8 × RGBW LEDs, 4-in-1, 10 W                            |                 |                |
| Beam angle                      | approx. 2°   |                 |                |
| Flash frequency (strobe effect) | 0 ... 20 Hz  |                 |                |
| Dimmer                          | 0 ... 100 % (12 bit)                                   |                 |                |
| Light power                     | Red:   | 5845 Lux / 1 m  | 549 Lux / 5 m  |
|                                 | Green:   | 18010 Lux / 1 m | 1252 Lux / 5 m |
|                                 | Blue:  | 4375 Lux / 1 m  | 166 Lux / 5 m  |
|                                 | White:   | 21160 Lux / 1 m | 1811 Lux / 5 m |
| Operating supply voltage        | 100 - 240 V ~ 50/60 Hz                                 |                 |                |
| Power consumption               | 104 W  |                 |                |
| Fuse                            | 5 mm × 20 mm, 3 A, 250 V, slow-blow                    |                 |                |

## Technical specifications

---

|                        |                          |
|------------------------|--------------------------|
| Dimensions (W × H × D) | 405 mm × 378 mm × 150 mm |
| Weight                 | 6.8 kg                   |



# 8 Plug and connection assignments

## Introduction

This chapter will help you select the right cables and plugs to connect your valuable equipment so that a perfect light experience is guaranteed.

Please take our tips, because especially in 'Sound & Light' caution is indicated: Even if a plug fits into a socket, the result of an incorrect connection may be a destroyed DMX controller, a short circuit or 'just' a not working light show!

## DMX connections

The unit offers a 3-pin XLR socket for DMX output and a 3-pin XLR plug for DMX input. Please refer to the drawing and table below for the pin assignment of a suitable XLR plug.



| Pin | Configuration                         |
|-----|---------------------------------------|
| 1   | Ground, shielding                     |
| 2   | Signal inverted (DMX-, 'cold signal') |
| 3   | Signal (DMX+, 'hot signal')           |

## 9 Troubleshooting



### **NOTICE!**

#### **Possible data transmission errors**

For error-free operation make use of dedicated DMX cables and do not use ordinary microphone cables.

Never connect the DMX input or output to audio devices such as mixers or amplifiers.

In the following we list a few common problems that may occur during operation. We give you some suggestions for easy troubleshooting:

| Symptom                           | Remedy  |
|-----------------------------------|---|
| The unit does not work, no light  | 1. Check the mains connection and the main fuse.  |
|                                   | 2. Check the settings in manual operation.  |
| No response to the DMX controller | 1. Check whether the DMX cables run near or parallel to high-voltage cables that may cause damage or interference to a DMX interface circuit. |
|                                   | 2. Try using another DMX controller.  |

If the procedures recommended above do not succeed, please contact our Service Center. You can find the contact information at [www.thomann.de](http://www.thomann.de).

## 10 Cleaning

### Optical lenses

Clean the optical lenses, that are accessible from the outside, regularly in order to optimize the light output. The frequency of cleaning depends on the operating environment: wet, smoky or particularly dirty surroundings can cause more accumulation of dirt on the optics of the device.

- Clean with a soft cloth using our lamp and lens cleaner (item no. 280122).
- Always dry the parts carefully.

### Fan grids

The fan grids of the device must be cleaned on a regular basis to remove dust and dirt. Before cleaning, switch off the device and disconnect AC-powered devices from the mains. Use a lint-free damp cloth for cleaning. Never use solvents or alcohol for cleaning.

## 11 Protecting the environment

### Disposal of the packaging material



For the transport and protective packaging, environmentally friendly materials have been chosen that can be supplied to normal recycling.

Ensure that plastic bags, packaging, etc. are properly disposed of.

Do not just dispose of these materials with your normal household waste, but make sure that they are collected for recycling. Please follow the notes and markings on the packaging.

### Disposal of your old device



This product is subject to the European Waste Electrical and Electronic Equipment Directive (WEEE). Do not dispose with your normal household waste.

Dispose of this device through an approved waste disposal firm or through your local waste facility. When discarding the device, comply with the rules and regulations that apply in your country. If in doubt, consult your local waste disposal facility.





Musikhaus Thomann · Hans-Thomann-Straße 1 · 96138 Burgebrach · Germany · [www.thomann.de](http://www.thomann.de)