



free solo Twin HT,
free solo Twin PT,
free solo Twin HTPT

UHF Wireless System

Thomann GmbH
Hans-Thomann-Straße 1
96138 Burgebrach
Germany
Telephone: +49 (0) 9546 9223-0
Internet: www.thomann.de

24.01.2025, ID: 380952, etc. (V6)

Table of contents

1	General information.....	6
	1.1 Symbols and signal words.....	6
2	Safety instructions.....	8
3	Features.....	11
4	Installation and starting up.....	15
	4.1 General Information.....	15
	4.2 Receiver.....	16
	4.3 Handheld microphone (HT series).....	17
	4.4 Bodypack transmitter (PT series).....	17
5	Connections and controls.....	18
	5.1 Receiver.....	18
	5.2 Handheld microphone.....	23
	5.3 Bodypack transmitter.....	25
6	Operating.....	28
	6.1 Receiver.....	28
	6.2 Handheld microphone.....	32
	6.3 Bodypack transmitter.....	35
7	Technical specifications.....	38
	7.1 Receiver.....	38

7.2	Handheld microphone.....	40
7.3	Bodypack transmitter.....	42
7.4	Overview of the scope of delivery.....	46
8	Plug and connection assignment.....	47
9	Troubleshooting.....	49
10	Protecting the environment.....	51



free solo Twin HT, free solo Twin PT, free solo Twin HTPT
UHF Wireless System

1 General information



This document contains important instructions for the safe operation of the product. Read and follow the safety instructions and all other instructions. Keep the document for future reference. Make sure that it is available to all those using the product. If you sell the product to another user, be sure that they also receive this document.

Our products and documentation are subject to a process of continuous development. They are therefore subject to change. Please refer to the latest version of the documentation, which is ready for download under www.thomann.de.

1.1 Symbols and signal words

In this section you will find an overview of the meaning of symbols and signal words that are used in this document.

Signal word	Meaning
DANGER!	This combination of symbol and signal word indicates an immediate dangerous situation that will result in death or serious injury if it is not avoided.
NOTICE!	This combination of symbol and signal word indicates a possible dangerous situation that can result in material and environmental damage if it is not avoided.

Warning signs	Type of danger
	Warning – high-voltage.
	Warning – danger zone.

2 Safety instructions

Intended use

This device is intended to be used for the wireless transmission of audio signals from microphones or instruments to amplifiers or active speakers. Use the device only as described in this user manual. Any other use or use under other operating conditions is considered to be improper and may result in personal injury or property damage. No liability will be assumed for damages resulting from improper use.

This device may be used only by persons with sufficient physical, sensorial, and intellectual abilities and having corresponding knowledge and experience. Other persons may use this device only if they are supervised or instructed by a person who is responsible for their safety.

Safety



DANGER!

Risk of injury and choking hazard for children!

Children can suffocate on packaging material and small parts. Children can injure themselves when handling the device. Never allow children to play with the packaging material and the device. Always store packaging material out of the reach of babies and small children. Always dispose of packaging material properly when it is not in use. Never allow children to use the device without supervision. Keep small parts away from children and make sure that the device does not shed any small parts (such knobs) that children could play with.



DANGER!

Danger to life due to electric current!

Within the device there are areas where high voltages may be present. Never remove any covers. There are no user-serviceable parts inside. Do not use the device when covers, safety equipment or optical components are missing or damaged.

**NOTICE!****Damage to the external power supply due to high voltages!**

The device is powered by an external power supply. The external power supply can be damaged if it is operated with the incorrect voltage or if high voltage peaks occur. In the worst case, excess voltages can also cause a risk of injury and fires. Make sure that the voltage specification on the external power supply matches the local power grid before plugging in the power supply. Only operate the external power supply from professionally installed mains sockets that are protected by a residual current circuit breaker (FI). Ensure that the power cord plug is easily accessible at all times if it is the only device to safely disconnect the device from the mains supply. As a precaution, disconnect the power supply from the power grid when storms are approaching or if the device will not be used for a longer period.

**NOTICE!****Damage to the device due to use of unsuitable external power supplies!**

If the device is operated with an unsuitable external power supply, the device can be damaged by overvoltage or incorrect polarity. If things go badly, using an unsuitable power supply can also cause a risk of injury and fire. Only use the external power supply designated for the device or an equivalent external power supply with identical parameters. If in doubt, compare the voltage specifications on the external power supply and the polarity (+/-) with the specifications in this manual and printed on the device. Voltage and polarity must always match.

**NOTICE!****Damage to the device if operated in unsuitable ambient conditions!**

The device can be damaged if it is operated in unsuitable ambient conditions. Only operate the device indoors within the ambient conditions specified in the "Technical specifications" chapter of this user manual. Avoid operating it in environments with direct sunlight, heavy dirt and strong vibrations. Avoid operating it in environments with strong temperature fluctuations. If temperature fluctuations cannot be avoided (for example after transport in low outside temperatures), do not switch on the device immediately. Never subject the device to liquids or moisture. Never move the device to another location while it is in operation. In environments with increased dirt levels (for example due to dust, smoke, nicotine or mist): Have the device cleaned by qualified specialists at regular intervals to prevent damage due to overheating and other malfunctions.



NOTICE!

Risk of fire due to incorrect polarity!



Incorrectly inserted batteries may cause fires and destroy the device and the batteries. Observe the markings on the batteries and on the device. Ensure that proper polarity is observed when inserting batteries.



NOTICE!

Possible damage due to leaking batteries!



Batteries can leak and cause permanent damage to the device. Take the batteries out of the device if it is not going to be used for an extended period of time.



NOTICE!

Possible staining due to plasticiser in rubber feet!



The plasticiser in the rubber feet of this product may react with the coating of the floor, resulting in permanent dark stains after a while. If necessary, use a suitable mat or felt pads to prevent direct contact between the product's rubber feet and the floor.

3 Features

The UHF wireless system is particularly suitable for professional audio transmission, for example at events, on rock stages and in concert halls, theatres, musicals or night clubs.

The UHF Wireless System free solo Twin HT consists of the following components:

- 19-inch Diversity receiver
 - Two antennas for optimum reception quality
 - Automatic frequency scanning
 - Infrared interface for sending the frequency selection from the receiver to the transmitter
 - Adjustable squelch
 - Outputs: XLR, 6.35-mm jack socket
 - Suitable for mounting in a 19-inch rack (1 RU)
 - Power supply: 12...18 V $\overline{\text{DC}}$, a suitable power adapter is included
- Transmitter: two battery powered handheld cardioid microphones

The UHF Wireless System free solo Twin PT consists of the following components:

- 19-inch Diversity receiver
 - Two antennas for optimum reception quality
 - Automatic frequency scanning
 - Infrared interface for sending the frequency selection from the receiver to the transmitter
 - Built-in antenna splitter, a maximum of 4 devices can be cascaded to two antennas
 - Adjustable squelch
 - Outputs: XLR, 6.35-mm jack socket
 - Suitable for mounting in a 19-inch rack (1 RU)
 - Power supply: 12...18 V $\overline{\text{DC}}$, a suitable power adapter is included
- Transmitter: two battery powered bodypack transmitters

The UHF Wireless System free solo Twin HTPT consists of the following components:

- 19-inch Diversity receiver
 - Two antennas for optimum reception quality
 - Automatic frequency scanning
 - Infrared interface for sending the frequency selection from the receiver to the transmitter
 - Built-in antenna splitter, a maximum of 4 devices can be cascaded to two antennas
 - Adjustable squelch
 - Outputs: XLR, 6.35-mm jack socket
 - Suitable for mounting in a 19-inch rack (1 RU)
 - Power supply: 12...18 V $\overline{\text{DC}}$, a suitable power adapter is included
- Transmitter:
 - One battery powered bodypack transmitter
 - One battery powered handheld cardioid microphone

Depending on the ambient conditions, it is possible to operate three parallel systems, or two parallel systems at 823MHz, and to mount them in one rack.

The systems operate with pre-programmed frequency groups. The following table shows the number of available pre-programmed groups and the number of pre-programmed frequencies in each group.

Type	Pre-programmed frequency groups	Available channels per group
the t.bone free solo 520 MHz	10	12
the t.bone free solo 590 MHz	16 + 2 user groups	14
the t.bone free solo 660 MHz	14	16
the t.bone free solo 823 MHz	8	8



The frequency lists are available for download on the product page at www.thomann.de.

4 Installation and starting up

4.1 General Information

Unpack and check carefully there is no transportation damage before using the unit. Keep the equipment packaging. To fully protect the product against vibration, dust and moisture during transportation or storage use the original packaging or your own packaging material suitable for transport or storage, respectively.

Create all connections while the device is off. Use the shortest possible high-quality cables for all connections. Take care when running the cables to prevent tripping hazards.

Notes on wireless transmission

- This device utilizes frequencies that are not harmonized within the European Union (EU) and therefore may only be used in certain EU member states. In all European countries, the frequencies used for the transmission of audio signals are strictly regulated. Before you start, make sure the frequencies are allowed in the respective country and check whether the operation must be reported to the appropriate authority.
For more information, please visit: <http://www.thomann.de>.
- Make sure that transmitter and receiver are both tuned to the same channel.
- Never set multiple transmitters to the same channel.
- Make sure that there are no metal objects between the transmitter and receiver.
- Avoid interference from other radio or in-ear systems.

4.2 Receiver

Rack mounting

The device is designed for mounting in a standard 19-inch rack; it occupies one rack unit (RU). The fixing material required for assembly is included.

Connecting the power supply

First, connect the power supply to the receiver and then plug the power supply into the power outlet.

Attaching the antennas

Attach the included antennas to the rear panel of the transmitter. The antenna can be rotated and swivelled to improve transmission quality and to adapt to spatial conditions.

If there is not enough space on the device for direct assembly of the antennas, for example because there is not much space in the rack, you can use the optionally available coaxial cable to assemble the antennas separately from the device.

Connecting audio and starting up

Connect the audio outputs of the receiver to your mixer or your amplifier. Ensure that only one of the two outputs of the receiver (XLR or jack) is ever used at a time for each channel, because faults might occur otherwise.

4.3 Handheld microphone (HT series)

Inserting batteries

Unscrew the bottom housing section of the handheld microphone. Insert the batteries. Pay attention to the correct location of the poles. The correct battery arrangement is illustrated in the battery compartment. Close the battery compartment, screw the bottom housing section back on, and switch the transmitter on.

4.4 Bodypack transmitter (PT series)

Inserting batteries

Open the lid of the battery compartment by sliding it in the direction of the arrow, and insert the batteries. Pay attention to the correct location of the poles. Close the battery compartment and switch the transmitter on.

Connecting a microphone or instrument

- Ensure that the transmitter is switched off.
- Connect the microphone cable or instrument cable to the input on the transmitter (mini-XLR panel connector).
- Turn on the transmitter and check the transmission by using the microphone or instrument. If necessary, adjust the amplification of the transmitter and the levels on your mixing console or your amplifier.

5 Connections and controls

5.1 Receiver

Front panel

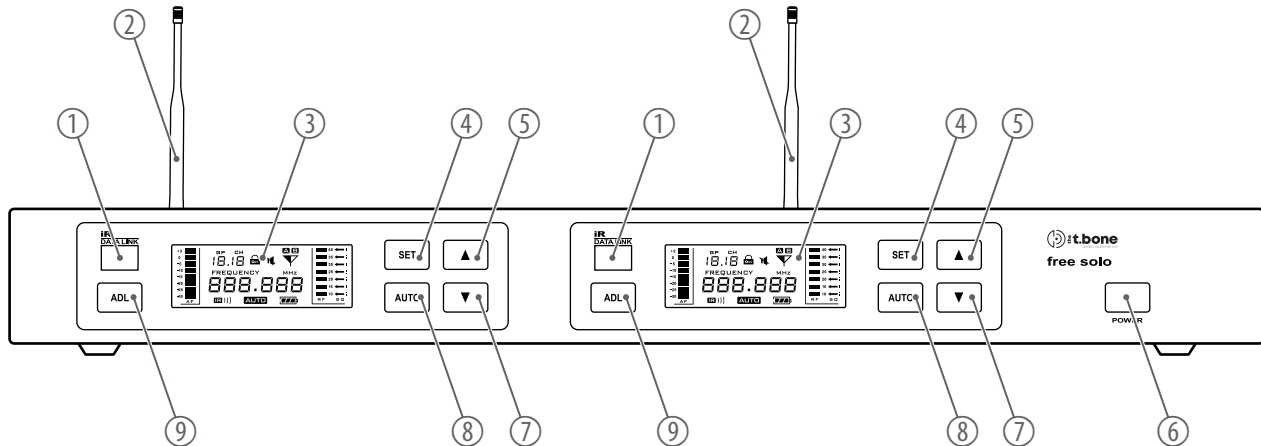

1	Infrared receiver
2	UHF antenna. Two antennas are available per channel.
3	Display
4	[<i>SET</i>] Opens the menu.
5	▲ Increases the displayed value by one.
6	[<i>POWER</i>] Press the switch for several seconds to switch the device on or off. All previous settings are retained even when you switch the device off and disconnect it from the mains.
7	▼ Decreases the displayed value by one.
8	[<i>AUTO</i>] Starts an automatic search to find a free channel.
9	[<i>ADL</i>] Starts the synchronisation of the settings with the transmitter.

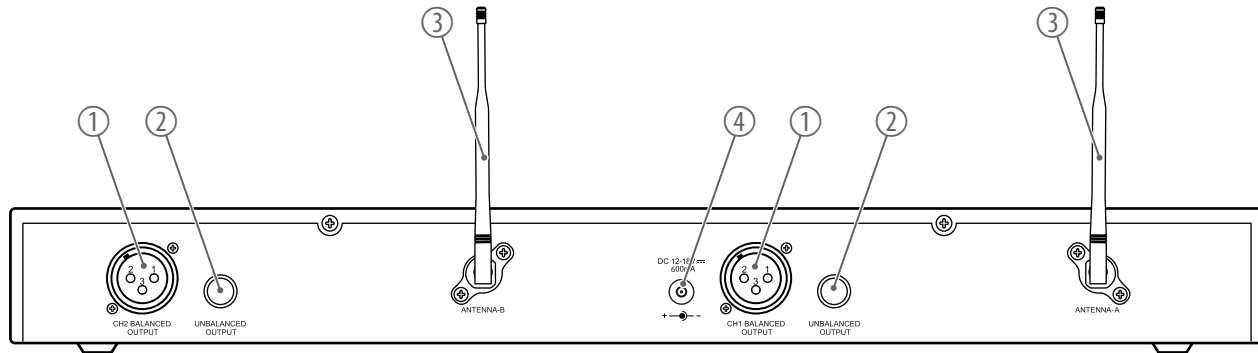

Rear panel

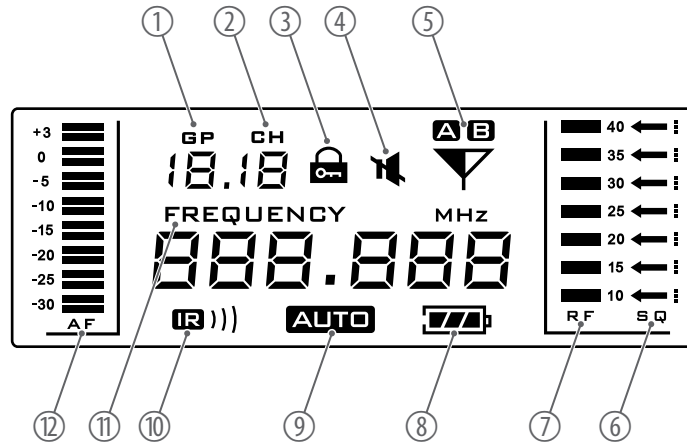

- 1 **[BALANCED OUTPUT]** | XLR panel plug as balanced audio signal output for direct connection to a mixer, power amplifier or recording device.
- 2 **[UNBALANCED OUTPUT]** | 6.35-mm jack socket as unbalanced audio signal output for direct connection to a mixer, power amplifier or recording device.
- 3 **[ANTENNA-B]** | UHF antenna. One antenna is available per channel.
- 4 **[DC 12-18V]** | Socket for connecting the supplied external power supply. If you are using a different power supply, observe the correct voltage, the polarity of the plug and the power consumption.

Display



1	<i>[GP]</i> Displays the selected frequency group.
2	<i>[CH]</i> Displays the selected channel.
3	 Indicates that the device is locked to prevent unintentional changes.
4	 Indicates that the receiver is not receiving a signal, e.g. because the transmitter is disabled, the connection is interrupted or the channel is currently changing.
5	<i>[A/B]</i> Indicates which of the two antennas is currently being used for signal transmission.
6	<i>[SQ]</i> Shows the set squelch level for the radio signal. Setting the squelch too high will lower the dynamics of the system.
7	<i>[RF]</i> Shows the level of the received radio signal.
8	Shows the battery status of the transmitter from which the device is currently receiving a signal.
9	<i>[AUTO]</i> Shows that an automatic search is running to find a free channel.
10	<i>[IR]</i> Indicates that an infrared signal is being received.
11	<i>[FREQUENCY]</i> Indicates the frequency that is assigned to the set combination of frequency group and channel.
12	<i>[AF]</i> Level display for the audio signal

5.2 Handheld microphone

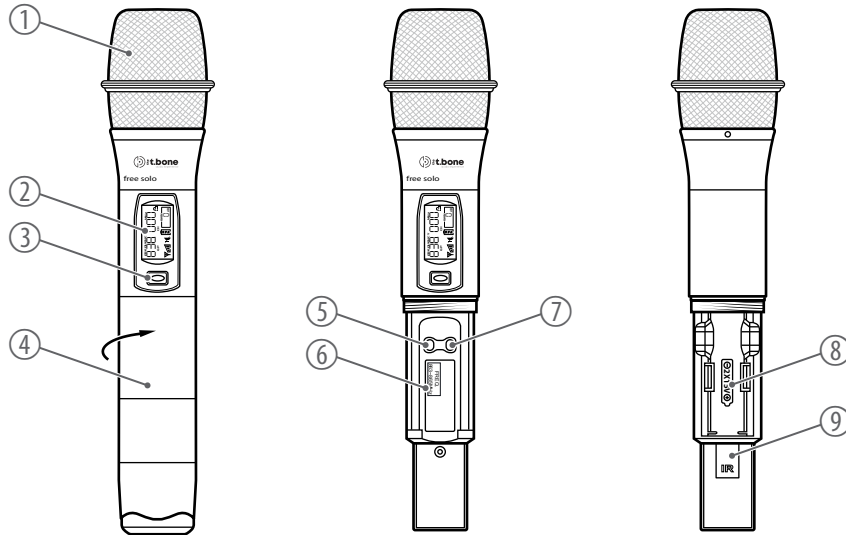

1	Microphone head grill to prevent damage and to reduce wind and breathing noises.
2	Display (see ↪ <i>Table on page 27</i>)
3	Main switch. Press the switch for several seconds to switch the device on or off. Press the switch briefly to mute or unmute the microphone. When the transmitter is muted, the M symbol does not appear on the receiver display.
4	Lower housing part. Unscrew to open.
5	[SET] Opens the menu.
6	[SEL] Selects a menu item.
7	Indication of the frequency range in which the device operates. The specification here must match the specification printed on the back of the receiver.
8	Battery holder for two round cell batteries (AA, LR06), 1.5 V or comparable rechargeable batteries.
9	Infrared sensor

5.3 Bodypack transmitter

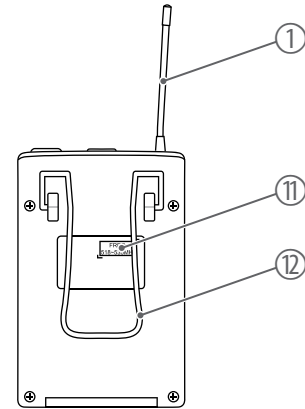
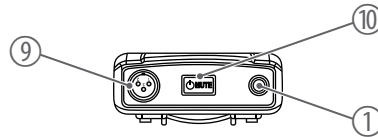
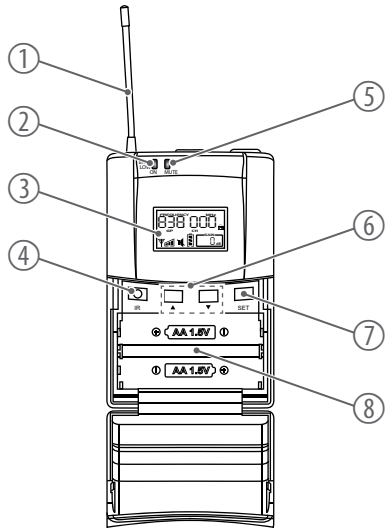

1	Antenna
2	[BATT LOW] / [ON] Flashes when the battery level is too low.
3	Display (see ↪ <i>Table on page 27</i>)
4	[IR] Infrared sensor
5	[MUTE] Indicates that the device is muted.
6	Buttons ▲ / ▼ Increases or decreases the currently displayed value.
7	[SET] Opens the menu.
8	Battery holder for two round cell batteries (AA, LR06), 1.5 V or comparable rechargeable batteries.
9	INPUT. Mini-XLR panel plug for connecting a microphone or instrument.
10	Main switch. Press the switch for several seconds to switch the device on or off. Press the switch briefly to mute the input. When the transmitter is muted, the 🎤 symbol does not appear on the receiver display.
11	Indication of the frequency range in which the device operates.
12	Retaining clamp

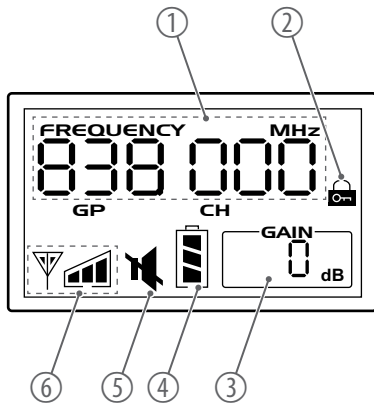

- | | |
|---|---|
| 1 | <i>[FREQUENCY]</i> / <i>[GP]</i> / <i>[CH]</i> Depending on the selected menu item: <ul style="list-style-type: none"> ■ Displays the frequency that is assigned to the set combination of frequency group and channel. ■ Displays the set frequency group and the set channel. |
| 2 | 🔒 Indicates that the device is locked to prevent unintentional changes. |
| 3 | <i>[GAIN]</i> Displays the level of the transmitted radio signal. |
| 4 | Battery level indicator. Replace the batteries when only one blinking bar is displayed. If the battery voltage drops any further the transmitter is switched off automatically. The battery status is also shown on the receiver. |
| 5 | 🔇 Shows that the transmitter has been muted. This is the case if you have muted the transmitter by briefly pressing the main switch. |
| 6 | Shows the output power. |

6 Operating

6.1 Receiver

Selecting a frequency

1. ▶ Press [SET].
⇒ The [GP] display flashes.
2. ▶ Use the arrow buttons to select the frequency group.



The frequency lists are available for download on the product page at www.thomann.de.

Press [SET] to confirm the selection.

⇒ The [CH] display flashes.

3. Use the arrow buttons to select a channel within the set frequency group.

If you have selected frequency group 'U', you can use the arrow buttons to set the frequency directly in 25-kHz increments. First set the value before the decimal point and press *[SET]*, then set the value after the decimal point.

Press *[SET]* to confirm the selection.

- ⇒ The display shows that the receiver is being tuned to the new frequency. After a few seconds, the display shows the default state again.

Synchronising transmitter and receiver

1. Open the transmitter to expose the infrared sensor.
2. Press *[ADL]* The *[IR]* display flashes.
3. Hold the infrared sensor of the transmitter near the infrared interface of the receiver within ten seconds.
4. When synchronization has been successfully completed, the *[IR]* display stops flashing.
⇒ After three seconds, the display shows the default state again.

Setting squelch

1. Press and hold *[SET]* until the *[SQ]* area flashes on the display.
2. Use the arrow buttons to set the desired value. The current value is shown on the right side of the display.

3. ▶ Press *[SET]* to confirm the selection.
⇒ After three seconds, the display shows the default state again.



Setting the output level

1. ▶ Press and hold *[SET]* until the *[AF]* area flashes on the display.
2. ▶ Use the arrow buttons to set the desired value. The current value is shown on the left side of the display.
3. ▶ Press *[SET]* to confirm the selection.
⇒ After three seconds, the display shows the default state again.

Automatic search for a free channel

1. ▶ Press *[AUTO]*.
⇒ The *[AUTO]* display flashes, the display shows the number of free channels available.
2. ▶ Use the arrow buttons to select one of the free channels.
Press *[SET]* to confirm the selection.
⇒ After three seconds, the display shows the default state again.
3. ▶ If the system does not find a free channel within five seconds, it automatically returns to the default state.

Locking or unlocking the keypad

- 1.** ▶ Press and hold *[SET]* until the  symbol appears.
 - ⇒ All buttons except for the main switch are locked.
- 2.** ▶ To unlock the keypad, press *[SET]* until the  symbol is no longer visible.
 - ⇒ The buttons have their original function again.

6.2 Handheld microphone

The buttons for operating the device are accessible if you unscrew the bottom housing section.

Selecting a frequency

If you do not wish to synchronise the transmitter with the receiver using the infrared interface, you can set the transmission frequency manually in the configurable frequency group (user bank).

1. ➤ Press *[SET]* repeatedly until the value in the *[GP]* field flashes on the display.
2. ➤ Use *[SEL]* to select the frequency group.



The frequency lists are available for download on the product page at www.thomann.de.

Press *[SET]* to confirm the selection.

⇒ The number in the *[CH]* field flashes.

3. Use *[SEL]* to select a channel within the set frequency group.

If you have selected frequency group "U", you can use *[SEL]* to set the frequency directly. First set the value before the decimal point and press *[SET]*, then set the value after the decimal point.

Press *[SET]* to confirm the selection.

⇒ After a few seconds, the display shows the default state again.

Setting the gain

1. Press *[SET]* repeatedly until the number in the *[GAIN]* field flashes on the display.

2. Use *[SEL]* to change the transmitter gain in increments of 3 dB (-3 dB, 0 dB, 3 dB, 6 dB, 9 dB).

Press *[SET]* to confirm the selection. Press the main switch to close the menu without making any changes.



Setting the transmission power

1. Press *[SET]* repeatedly until the  symbol flashes on the display.



2. Use *[SEL]* to change the transmission power (5 mW, 10 mW, 20 mW).

Press *[SET]* to confirm the selection. Press the main switch to close the menu without making any changes.

Displaying the frequency group and channel

1.  Press *[SEL]*.
 - ⇒ The display shows the frequency group and channel being used.
2.  Press *[SEL]* or wait five seconds to return to default state.

Locking the keypad

-  Press *[SEL]* until the  symbol appears.
 - ⇒ All buttons except for the main switch are locked.

Unlocking the keypad

-  To cancel the key lock, press *[SET] → [SEL] → [SET] → [SEL] → [SET] → [SEL]*.
 - ⇒ The buttons have their original function again.

6.3 Bodypack transmitter

The buttons for operating the device are located under the flap on the front.

Selecting a frequency

If you do not wish to synchronise the transmitter with the receiver using the infrared interface, you can set the transmission frequency manually in the configurable frequency group (user bank).

1. ➤ Press *[SET]* repeatedly until the value in the *[GP]* field flashes on the display.
2. ➤ Use the arrow buttons to select the frequency group.



The frequency lists are available for download on the product page at www.thomann.de.

Press *[SET]* to confirm the selection.

⇒ The number in the *[CH]* field flashes.

3. Use the arrow buttons to select a channel within the set frequency group.

If you have selected frequency group “U”, you can use the arrow buttons to set the frequency directly. First set the value before the decimal point and press *[SET]*, then set the value after the decimal point.

Press *[SET]* to confirm the selection.

⇒ After a few seconds, the display shows the default state again.

Setting the gain

1. Press *[SET]* repeatedly until the number in the *[GAIN]* field flashes on the display.
2. Use the arrow buttons to change the transmitter gain in increments of 3 dB (–3 dB, 0 dB, 3 dB, 6 dB, 9 dB).



Press *[SET]* to confirm the selection. Press the main switch to close the menu without making any changes.

Setting the transmission power

1. Press *[SET]* repeatedly until the  symbol flashes on the display.
2. Use the arrow keys to change the transmitter power (5 mW, 10 mW, 20 mW).

Press *[SET]* to confirm the selection. Press the main switch to close the menu without making any changes.

Displaying the frequency group and channel

1.  Press **▼**.
 - ⇒ The display shows the frequency group and channel being used.
2.  Press **[SET]** or wait five seconds to return to normal state.

Locking the keypad

-  Press **▲** until the **🔒** symbol appears.
 - ⇒ All buttons except for the main switch are locked.

Unlocking the keypad

-  To cancel the key lock, press **[SET] → ▲ → [SET] → ▲ → [SET] → ▲**.
 - ⇒ The buttons have their original function again.

7 Technical specifications

7.1 Receiver

Number of systems that can be operated in parallel	520/590/660 MHz	3 systems
	823 MHz	2 systems
Input connections	Power supply	Socket for connecting the supplied power supply
Output connections	Balanced audio signal output for direct connection to a mixer, a power amplifier or recording device	1× XLR panel plug, balanced
	Unbalanced audio signal output for direct connection to a mixer, a power amplifier or a recording device	1× 6.35-mm jack socket, unbalanced
Output level adjustment	−43 dB ... +0 dB	
Sensitivity	−102 dBm	
Antenna gain	2.15 dBi	
NF frequency response	50 Hz... 15 kHz (±3 dB)	
Total harmonic distortion (THD)	< 0.8%	

Signal-to-noise ratio	> 105 dB (A)	
Power supply	External power adapter, 100 - 240 V ~ 50/60 Hz	
Operating voltage/current	12...18 V $\overline{\text{---}}$ / min. 600 mA, polarity: Centre positive	
Dimensions (W × H × D), without antennas	412 mm × 44 mm × 160 mm	
Weight	2 kg	
Ambient conditions	Temperature range	0 °C...40 °C
	Relative humidity	20%...80% (non-condensing)

Carrier frequency, frequency band, number of channels, bandwidth, switching bandwidth and modulation type correspond to those of the transmitter.

7.2 Handheld microphone

Frequency band	UHF band	
Max. transmission power	the t.bone free solo Twin HT 520 MHz (item no. 380952)	20 mW
	the t.bone free solo Twin HT 590 MHz (item no. 380953)	
	the t.bone free solo Twin HT 660 MHz (item no. 380954)	
	the t.bone free solo Twin HT 823 MHz (item no. 380955)	
Frequency range	the t.bone free solo Twin HT 520 MHz (item no. 380952)	518 MHz...536 MHz
	the t.bone free solo Twin HT 590 MHz (item no. 380953)	584 MHz...608 MHz
	the t.bone free solo Twin HT 660 MHz (item no. 380954)	675 MHz...679 MHz
	the t.bone free solo Twin HT 823 MHz (item no. 380955)	823 MHz...832 MHz
Bandwidth	the t.bone free solo Twin HT 520 MHz (item no. 380952)	18 MHz

	the t.bone free solo Twin HT 590 MHz (item no. 380953)	24 MHz
	the t.bone free solo Twin HT 660 MHz (item no. 380954)	
	the t.bone free solo Twin HT 823 MHz (item no. 380955)	9 MHz
Modulation type	Frequency modulation (FM)	
Range of the infrared connection for the synchronisation between transmitter and receiver	80 mm	
NF frequency response	60 Hz...18 kHz	
Total harmonic distortion	< 0.5%	
Switching bandwidth	25 kHz	
Spurious rejection	> 55 dBc	
Peak deviation	± 55 kHz	
Signal-to-noise ratio	> 102 dB (A)	
Battery	Battery type	2 round cell batteries (AA, LR06) or comparable rechargeable batteries
	Voltage	1.5 V

	Operating time	> 8 h (with alkaline cells)
Dimensions (L × D)	246 mm × 53 mm	
Weight	250 g	
Ambient conditions	Temperature range	0 °C...40 °C
	Relative humidity	20%...80% (non-condensing)

7.3 Bodypack transmitter

Frequency band	UHF band	
Max. transmission power	the t.bone free solo Twin HT 520 MHz (item no. 380956)	20 mW
	the t.bone free solo Twin HT 590 MHz (item no. 380957)	
	the t.bone free solo Twin HT 660 MHz (item no. 380958)	
	the t.bone free solo Twin HT 823 MHz (item no. 380959)	
Maximum input level	6 dBV	

Frequency range	the t.bone free solo Twin HT 520 MHz (item no. 380956)	518 MHz...536 MHz
	the t.bone free solo Twin HT 590 MHz (item no. 380957)	584 MHz...608 MHz
	the t.bone free solo Twin HT 660 MHz (item no. 380958)	675 MHz...679 MHz
	the t.bone free solo Twin HT 823 MHz (item no. 380959)	823 MHz...832 MHz
Bandwidth	the t.bone free solo Twin HT 520 MHz (item no. 380956)	18 MHz
	the t.bone free solo Twin HT 590 MHz (item no. 380957)	24 MHz
	the t.bone free solo Twin HT 660 MHz (item no. 380958)	
	the t.bone free solo Twin HT 823 MHz (item no. 380959)	9 MHz
Number of channels	the t.bone free solo Twin HT 520 MHz (item no. 380956)	120
	the t.bone free solo Twin HT 590 MHz (item no. 380957)	252

Technical specifications

	the t.bone free solo Twin HT 660 MHz (item no. 380958)	240
	the t.bone free solo Twin HT 823 MHz (item no. 380959)	65
Modulation type	Frequency modulation (FM)	
Input impedance	Microphone	5 K Ω
	Guitar	1 M Ω
Range of the infrared connection for the synchronisation between transmitter and receiver	80 mm	
NF frequency response	60 Hz...18 kHz	
Total harmonic distortion	< 0.5%	
Switching bandwidth	25 kHz	
Spurious rejection	> 55 dBc	
Peak deviation	\pm 55 kHz	
Signal-to-noise ratio	> 102 dB (A)	
Battery	Battery type	2 round cell batteries (AA, LR06) or comparable rechargeable batteries
	Voltage	1.5 V

	Operating time	> 8 h (with alkaline cells)
Dimensions (W × H × D, without antennas)	64 mm × 98 mm × 23 mm	
Weight	90 g	
Ambient conditions	Temperature range	0 °C...40 °C
	Relative humidity	20%...80% (non-condensing)

Further information

Frequency band	UHF
Diversity	Yes
Switchable frequencies	Yes
Detachable antennas	Yes
Pilot tone	Yes
Capsule type	Dynamic

7.4 Overview of the scope of delivery

Item number	System	Scope of delivery
380952	the t.bone free solo Twin HT 520 MHz	1 × receiver, 2 × handheld microphone
380953	the t.bone free solo Twin HT 590 MHz	1 × receiver, 2 × handheld microphone
380954	the t.bone free solo Twin HT 660 MHz	1 × receiver, 2 × handheld microphone
380955	the t.bone free solo Twin HT 823 MHz	1 × receiver, 2 × handheld microphone
380963	the t.bone free solo Twin HT 823 MHz	1 × receiver, 1 × handheld microphone, 1 × bodypack transmitter
380956	the t.bone free solo Twin HT 520 MHz	1 × receiver, 2 × bodypack transmitter
380957	the t.bone free solo Twin HT 590 MHz	1 × receiver, 2 × bodypack transmitter
380958	the t.bone free solo Twin HT 660 MHz	1 × receiver, 2 × bodypack transmitter
380959	the t.bone free solo Twin HT 823 MHz	1 × receiver, 2 × bodypack transmitter

8 Plug and connection assignment

Introduction

This chapter will help you select the right cables and plugs to connect your valuable equipment in such a way that a perfect sound experience is ensured.

Please note these advices, because especially in 'Sound & Light' caution is indicated: Even if a plug fits into the socket, an incorrect connection may result in a destroyed power amp, a short circuit or 'just' in poor transmission quality!

Balanced and unbalanced transmission

Unbalanced transmission is mainly used in semi-professional environment and in hifi use. Instrument cables with two conductors (one core plus shielding) are typical representatives of the unbalanced transmission. One conductor is ground and shielding while the signal is transmitted through the core.

Unbalanced transmission is susceptible to electromagnetic interference, especially at low levels, such as microphone signals and when using long cables.

In a professional environment, therefore, the balanced transmission is preferred, because this enables an undisturbed transmission of signals over long distances. In addition to the conductors 'Ground' and 'Signal', in a balanced transmission a second core is added. This also transfers the signal, but phase-shifted by 180°.

Since the interference affects both cores equally, by subtracting the phase-shifted signals, the interfering signal is completely neutralized. The result is a pure signal without any noise interference.

1/4" TS phone plug (mono, unbalanced)



1	Signal
2	Ground, shielding

1/4" TRS phone plug (mono, balanced)



1	Signal (in phase, +)
2	Signal (out of phase, -)
3	Ground

XLR plug (balanced)

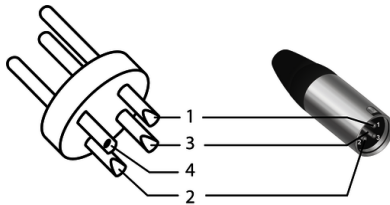

1	Ground, shielding
2	Signal (in phase, +)
3	Signal (out of phase, -)
4	Shielding on plug housing (option)

9 Troubleshooting

In the following we list a few common problems that may occur during operation. We give you some suggestions for easy troubleshooting:

Symptom	Remedy
No sound	<ol style="list-style-type: none"> <li data-bbox="627 440 1525 486">1. Check the power supply of the transmitter and receiver. <li data-bbox="627 491 1525 564">2. Make sure that transmitter and receiver are operating in the same frequency range. The frequency range can be found on the devices. <li data-bbox="627 570 1525 616">3. Are the transmitter and receiver set to the same channel? <li data-bbox="627 621 1525 745">4. Test the connection between the receiver and the connected audio device (amplifier, mixer). Is the connected audio device turned on and does the signal level on the output of the receiver match the input requirements of the audio device? <li data-bbox="627 751 1525 824">4. See if the audio transmission works when you move the transmitter closer to the receiver. <li data-bbox="627 829 1525 902">6. Make sure that no metal objects near the transmitter or receiver are obstructing the transmission.
Transmission is interrupted	<ol style="list-style-type: none"> <li data-bbox="627 913 1525 955">1. Modify the orientation of the antennas.

Symptom	Remedy
	2. If you are using more than one wireless system at the same time, check the used frequencies and channels.
	3. Interference can also be caused by other radio or in-ear systems.

If the procedures recommended above do not succeed, please contact our Service Center. You can find the contact information at www.thomann.de.

10 Protecting the environment

Disposal of the packing material

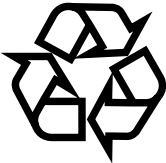

Environmentally friendly materials have been chosen for the packaging. These materials can be sent for normal recycling. Ensure that plastic bags, packaging, etc. are disposed of in the proper manner.

Do not dispose of these materials with your normal household waste, but make sure that they are collected for recycling. Please follow the instructions and markings on the packaging.

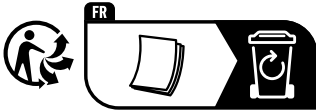

Observe the disposal note regarding documentation in France.

Disposal of batteries and rechargeable batteries



Do not dispose of batteries and rechargeable batteries with normal household waste, but in accordance with the local regulations for the disposal of hazardous waste. Use the available collection sites or contact your local waste disposal facility.

Before disposing of your old device, remove the batteries if this is possible without destroying it.

Disposal of your old device

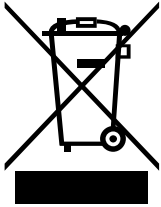

This product is subject to the European Waste Electrical and Electronic Equipment Directive (WEEE) as amended.

Do not dispose of your old device with your normal household waste; instead, deliver it for controlled disposal by an approved waste disposal firm or through your local waste facility. If in doubt, consult your local waste management facility. You can also return the device to a retailer if they offer to take the device back for free or if they are legally obliged to do so. When disposing of the device, comply with the rules and regulations that apply in your country. You can also return your old device to Thomann GmbH at no charge. Check the current conditions on www.thomann.de.

Proper disposal protects the environment as well as the health of your fellow human beings. This is because the proper handling of old devices negates the potential negative effects of hazardous substances, and because it conserves resources by recycling them.

Also note that waste avoidance is a valuable contribution to environmental protection. Repairing a device or passing it on to another user is an ecologically valuable alternative to disposal. For example, use the classified ads of Thomann GmbH.

If your old device contains personal data, delete those data before disposing of it.

