

**th•mann**

SP-320  
digital piano



Musikhaus Thomann  
Thomann GmbH  
Hans-Thomann-Straße 1  
96138 Burgebrach  
Germany  
Telephone: +49 (0) 9546 9223-0  
E-mail: [info@thomann.de](mailto:info@thomann.de)  
Internet: [www.thomann.de](http://www.thomann.de)

13.08.2020, ID: 381525 (V2)

## Table of contents

<b>1</b>	<b>General information</b> .....	<b>4</b>
	1.1 Further information.....	4
	1.2 Notational conventions.....	4
	1.3 Symbols and signal words.....	5
<b>2</b>	<b>Safety instructions</b> .....	<b>6</b>
<b>3</b>	<b>Features</b> .....	<b>8</b>
<b>4</b>	<b>Installation</b> .....	<b>9</b>
<b>5</b>	<b>Connection options</b> .....	<b>12</b>
<b>6</b>	<b>Control panel and connections</b> .....	<b>13</b>
<b>7</b>	<b>Operating</b> .....	<b>15</b>
	7.1 Turning on / off.....	15
	7.2 Automatic shutoff.....	15
	7.3 Adjusting the volume.....	15
	7.4 Setting the touch sensitivity.....	15
	7.5 Master Tuning / MIDI functions.....	16
	7.5.1 Master Tuning.....	16
	7.5.2 MIDI functions.....	16
	7.5.3 MIDI panic button.....	17
	7.5.4 Local On / Off.....	17
	7.5.5 Reset to factory defaults.....	18
<b>8</b>	<b>Functions</b> .....	<b>19</b>
	8.1 Playing demo songs.....	19
	8.2 Reverb and Chorus effects.....	19
	8.3 Metronome.....	19
	8.4 Transposing.....	20
	8.5 Layer mode.....	20
<b>9</b>	<b>Troubleshooting</b> .....	<b>21</b>
<b>10</b>	<b>Technical specifications</b> .....	<b>22</b>
<b>11</b>	<b>MIDI implementation chart</b> .....	<b>24</b>
<b>12</b>	<b>Function button allocation</b> .....	<b>26</b>
<b>13</b>	<b>Protecting the environment</b> .....	<b>30</b>

# 1 General information

This user manual contains important information on the safe operation of the device. Read and follow all safety notes and all instructions. Save this manual for future reference. Make sure that it is available to all persons using this device. If you sell the device to another user, be sure that they also receive this manual.

Our products and user manuals are subject to a process of continuous development. We therefore reserve the right to make changes without notice. Please refer to the latest version of the user manual which is ready for download under [www.thomann.de](http://www.thomann.de).

## 1.1 Further information

On our website ([www.thomann.de](http://www.thomann.de)) you will find lots of further information and details on the following points:

Download	This manual is also available as PDF file for you to download.
Keyword search	Use the search function in the electronic version to find the topics of interest for you quickly.
Online guides	Our online guides provide detailed information on technical basics and terms.
Personal consultation	For personal consultation please contact our technical hotline.
Service	If you have any problems with the device the customer service will gladly assist you.

## 1.2 Notational conventions

This manual uses the following notational conventions:

### Letterings

The letterings for connectors and controls are marked by square brackets and italics.

**Examples:** *[VOLUME]* control, *[Mono]* button.

### Displays

Texts and values displayed on the device are marked by quotation marks and italics.

**Examples:** '24ch', 'OFF'.

**Instructions**

The individual steps of an instruction are numbered consecutively. The result of a step is indented and highlighted by an arrow.

**Example:**

1. ➤ Switch on the device.
2. ➤ Press *[Auto]*.  
⇒ Automatic operation is started.
3. ➤ Switch off the device.

**1.3 Symbols and signal words**

In this section you will find an overview of the meaning of symbols and signal words that are used in this manual.

Signal word	Meaning
<b>DANGER!</b>	This combination of symbol and signal word indicates an immediate dangerous situation that will result in death or serious injury if it is not avoided.
<b>CAUTION!</b>	This combination of symbol and signal word indicates a possible dangerous situation that can result in minor injury if it is not avoided.
<b>NOTICE!</b>	This combination of symbol and signal word indicates a possible dangerous situation that can result in material and environmental damage if it is not avoided.
Warning signs	Type of danger
	Warning – danger zone.

## 2 Safety instructions

### Intended use

This device is intended to be used for electronic sound generation using a piano keyboard. Use the device only as described in this user manual. Any other use or use under other operating conditions is considered to be improper and may result in personal injury or property damage. No liability will be assumed for damages resulting from improper use.

This device may be used only by persons with sufficient physical, sensorial, and intellectual abilities and having corresponding knowledge and experience. Other persons may use this device only if they are supervised or instructed by a person who is responsible for their safety.

### Safety



#### **DANGER!**

##### **Danger for children**

Ensure that plastic bags, packaging, etc. are disposed of properly and are not within reach of babies and young children. Choking hazard!

Ensure that children do not detach any small parts (e.g. knobs or the like) from the unit. They could swallow the pieces and choke!

Never let children unattended use electrical devices.



#### **CAUTION!**

##### **Possible hearing damage**

With loudspeakers or headphones connected, the device can produce volume levels that may cause temporary or permanent hearing impairment.

Do not operate the device permanently at a high volume level.

Decrease the volume level immediately if you experience ringing in your ears or hearing impairment.



#### **NOTICE!**

##### **Operating conditions**

This device has been designed for indoor use only. To prevent damage, never expose the device to any liquid or moisture. Avoid direct sunlight, heavy dirt, and strong vibrations.



**NOTICE!**

**External power supply**

The device is powered by an external power supply. Before connecting the external power supply, ensure that the input voltage (AC outlet) matches the voltage rating of the device and that the AC outlet is protected by a residual current circuit breaker. Failure to do so could result in damage to the device and possibly the user.

Unplug the external power supply before electrical storms occur and when the device is unused for long periods of time to reduce the risk of electric shock or fire.



**NOTICE!**

**Risk of fire due to incorrect polarity**

Incorrectly inserted batteries may destroy the device or the batteries.

Ensure that proper polarity is observed when inserting batteries.



**NOTICE!**

**Possible damage by leaking batteries**

Leaking batteries can cause permanent damage to the device.

Take batteries out of the device if it is not going to be used for a longer period.

### 3 Features

The digital piano is characterized by the following features:

- 88 light weighted keys
- 12 selectable timbres
- Polyphony: 32-voice
- Layer mode
- Reverb and Chorus effects
- Integrated metronome
- 12 Demo songs, playback tempo adjustable
- Connections: Headphones, USB to host (MIDI / audio), LINE OUT (L / R), sustain pedal
- Voltage supply: via the supplied power adapter or 6 D cells (LR20, 1.5 V)



## 4 Installation

### Mains connection

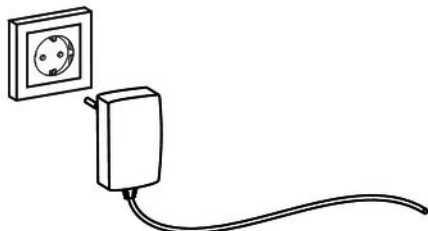

1. Make sure that the device is turned off before you connect it to the power supply or disconnect it.
2. Turn the volume control to minimum.
3. Connect the included power adapter to the 12V connector of the unit and then plug the power adapter into a wall outlet.
4. Now you can turn on the device.



*If the piano is not in use or when a thunderstorm with danger of lightning threatens, disconnect the device from its mains power for safety.*

### Battery operation



#### **NOTICE!**

##### **Risk of fire due to incorrect polarity**

Incorrectly inserted batteries may destroy the device or the batteries.  
Ensure that proper polarity is observed when inserting batteries.



#### **NOTICE!**

##### **Possible damage by leaking batteries**

Leaking batteries can cause permanent damage to the device.  
Take batteries out of the device if it is not going to be used for a longer period.

## Assembly overview

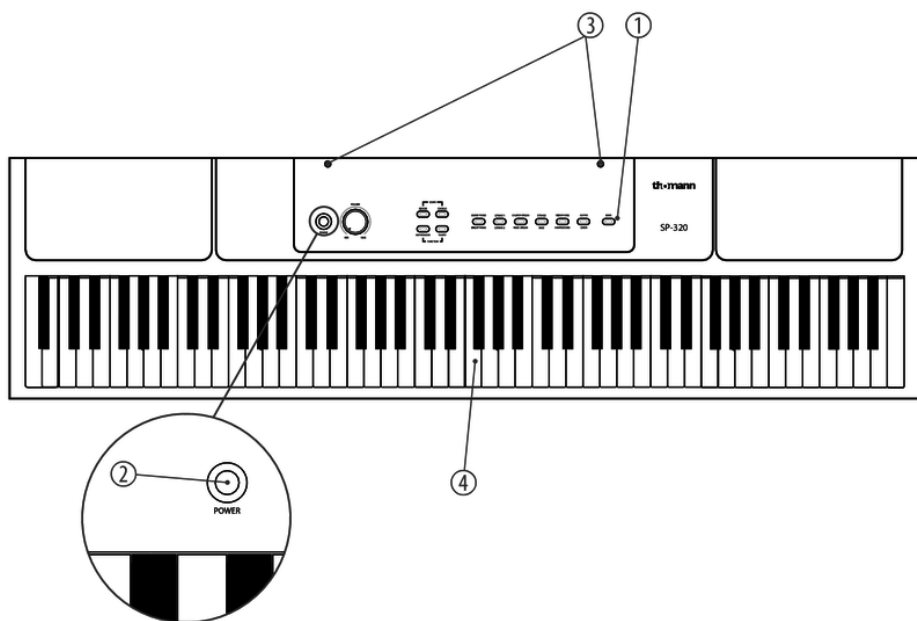

1	Operating panel
2	Main switch
3	Holes for music stand
4	Claviature

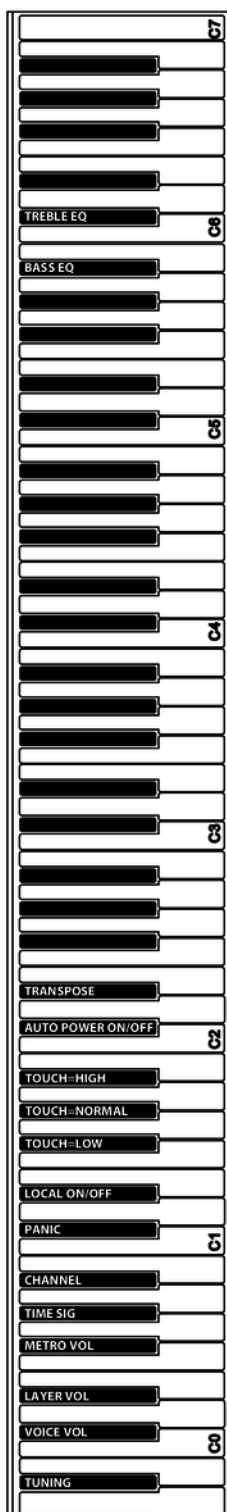

## 5 Connection options

### Headphones

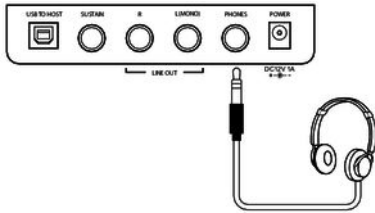

The headphones output is located on the rear side of the device.

Connecting headphones (not supplied) to the headphones output mutes the speakers.

### Pedal

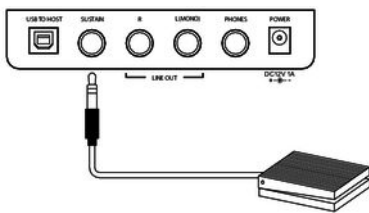

Connect the supplied Sustain pedal to the provided connector on the rear side of the device.

Pedal functions:

#### Sustain pedal

With the sustain pedal all played notes sound longer. This effect simulates the lifting of the damper in an analogue keyboard instrument.

### USB to host

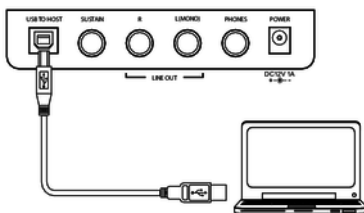

Via this output, the MIDI data generated by the digital piano are transferred to a PC (MIDI stands for 'Musical Instrument Digital Interface' and enables the electronic interaction of various instruments and sound modules as a worldwide standard).

At the same time, the audio signal from the digital piano is transmitted to a connected PC via this output and can be recorded and reproduced using appropriate software.

### External audio devices Line Out (L / R)

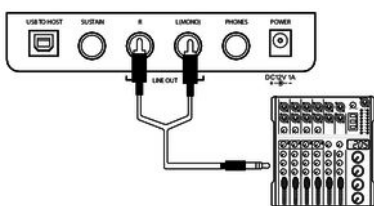

Use the *[LINE OUT]* sockets to connect the digital piano to an amplifier, stereo device, mixing console or recording device. Plug one end of the audio cable into the *[LINE OUT]* sockets in the connection box of the digital piano and the other end into the input of the respective audio device.



#### NOTICE!

To prevent damage to the speakers, turn the volume down to 'Minimum' before you connect other devices to the digital piano.

## 6 Control panel and connections

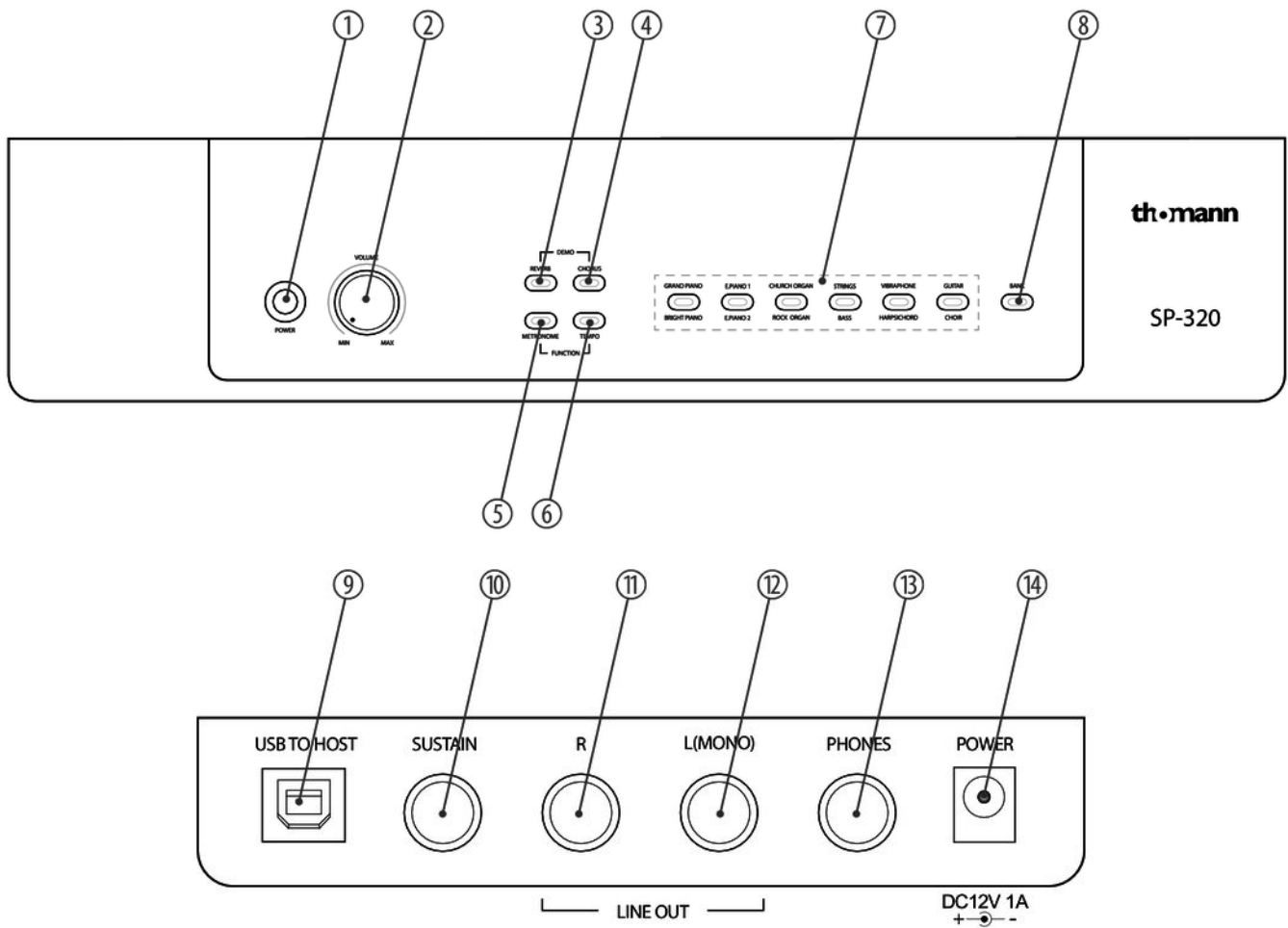

1	<b>[POWER]</b> Main switch. Turns the device on and off.
2	<b>[VOLUME]</b> Volume control for the built-in speakers and connected headphones.
3	<b>[DEMO/REVERB]</b> Button to engage the Reverb effect.
4	<b>[DEMO/CHORUS]</b> Button to engage the Chorus effect.
5	<b>[FUNCTION/METRONOME]</b> Button to turn the metronome on and off.

## Control panel and connections

---

6	<i>[FUNCTION/TEMPO]</i> Button to adjust the metronome tempo.
7	<i>[GRAND PIANO / BRIGHT PIANO]</i> Voice select button Grand Piano / Bright Piano
	<i>[EPIANO1/EPIANO2]</i> Voice select button EPIANO1 and EPIANO2.
	<i>[CHURCH ORGAN/ROCK ORGAN]</i> Voice select button Church Organ / Rock Organ.
	<i>[STRINGS/BASS]</i> Voice select button Strings / Bass.
	<i>[VIBRAPHONE/HARPSICHORD]</i> Voice select button Vibraphone and Harpsichord.
	<i>[GUITAR/CHOIR]</i> Voice select button Guitar and Choir accompaniment.
8	<i>[BANK]</i> Toggle button to change the sound banks.

### Connection box

9	<i>[USB TO HOST]</i> USB interface to connect a computer.
10	<i>[SUSTAIN]</i> Sustain pedal connection.
11/12	<i>[LINE OUT][R]/[L(MONO)]</i> Output sockets for connecting the digital piano to an amplifier, stereo system, mixer or recording device.
13	<i>[PHONES]</i> 1/4" phone socket to connect headphones.
14	<i>[POWER]</i> DC12V1A port for an external power supply.

## 7 Operating

### 7.1 Turning on / off

Press the main switch *[POWER]* left in the operating panel to turn the device on and off. All LEDs now briefly flash.



*If you hear nothing coming from the speakers, the volume may be set to 'minimum'. To increase the volume, turn the volume knob clockwise.*

### 7.2 Automatic shutoff

When the digital piano is not being used for 30 minutes, it switches off automatically. To turn it back on again, press the main switch *[POWER]*.

#### Disabling automatic shutoff

First keep *[METRONOME]* and *[TEMPO]* pressed to enter Edit mode.

Press the piano key *[Cis3]* to enable or disable the automatic shutoff, respectively. The tone C3 is reproduced once if the automatic shutoff is enabled or twice if it is disabled.

Press *[METRONOME]* and *[TEMPO]* simultaneously to exit the Edit mode.

### 7.3 Adjusting the volume

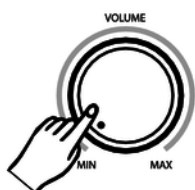

Turn the volume control *[VOLUME]* to adjust a pleasant volume for playback and practising. Turn the volume control clockwise to increase the volume. Turn it counter-clockwise to reduce the volume.

### 7.4 Setting the touch sensitivity

With this function you can adjust the touch response of the keyboard at three levels.

1. ➤ Keep *[METRONOME]* and *[TEMPO]* pressed to enter Edit mode. The LEDs of the two function buttons light up blue now.
  - ⇒ The LED of the button lights.
2. ➤ Press *[TOUCH]* to activate the function.
  - ⇒ The LED of the button lights.

3. ➤ Keep *[F#1]*, *[G#1]* and *[A#1]* pressed to adjust the touch sensitivity according to the table below.
4. ➤ The device automatically exits the edit mode.
  - ⇒ The LED of the button lights.

Setting	Meaning
'F#1'	Soft (0...30) In this setting, the volume is lower than usual even when playing with a hard touch.
'G#1'	Normal (31...70) This setting corresponds to the usual touch response of a keyboard (factory default setting).
'A#1'	Hard (71...127) In this setting, the volume is higher than usual even when playing with a soft touch.

## 7.5 Master Tuning / MIDI functions

In Edit mode, various parameters of the digital piano can be customized. Keep *[METRONOME]* and *[TEMPO]* pressed to enter the Edit mode.

### 7.5.1 Master Tuning

The piano is tuned to 440 Hz by default. That's why the piano does not need to be tuned after turning on. If desired, the tuning of the piano can be adjusted in small increments -50 and +50 (one semitone).

1. ➤ Enter the Edit mode. Keep *[METRONOME]* and *[TEMPO]* pressed.
2. ➤ Use *[A#-1]* to tune the piano in semitone increment.
3. ➤ Use *[METRONOME]* and *[TEMPO]* to exit the Edit mode.

### 7.5.2 MIDI functions

With this function you can activate the MIDI output of the digital piano. The MIDI out channels range from 1 to 16. Enter the Edit mode. Keep *[METRONOME]* and *[TEMPO]* pressed.



To change the value of the MIDI OUT channel, proceed as follows:

1. ➤ Press [A#0] according to the value of the desired MIDI out channel.
2. ➤ The number of hits on [C3] sets the value of the MIDI out channel. The default MIDI out channel is set to 1. Press [A#0] once in Edit mode. To confirm that the MIDI out channel is set to 1, the tone C3 is reproduced once.
3. ➤ Example: Pressing key [A#0] nine times will play the tone C3 ten times. This confirms that the MIDI out channel value has been set to 10.

### 7.5.3 MIDI panic button

Pressing the Panic button sends the commands 'Reset all controllers' and 'All sounds off' as MIDI messages to all MIDI channels from 1 – 16.



*This function can particularly be used when notes 'hang' in external MIDI devices or MIDI software.*

1. ➤ Enter the Edit mode. Keep [METRONOME] and [TEMPO] pressed.
2. ➤ Then press [C#1] to activate the Panic function. This sends general programme commands to reset the MIDI functions, like 'All notes off', etc.
3. ➤ When the panic reset is finished, the piano automatically returns to play mode.

### 7.5.4 Local On / Off

The Local On / Off function disconnects the keyboard from its internal sound system. This allows you to use the piano as a MIDI controller for other MIDI devices (or for virtual software instruments running on your computer). If you are running MIDI sequencing software, it is also recommended to run it in Local Off mode.

1. ➤ Enter the Edit mode. Keep [METRONOME] and [TEMPO] pressed.
2. ➤ Press [D#1] for Local On / Off
  - 'Local: ON' – built-in sound system activated (double key touch sound).
  - 'Local: OFF' – built-in sound system deactivated (single key touch sound).
3. ➤ Keep [METRONOME] and [TEMPO] pressed to exit the Edit mode.



*When switching off the built-in sound system, the speakers as well as the line and headphones outputs are switched off.*

### 7.5.5 Reset to factory defaults

Resetting to factory defaults clears the battery-powered memory and resets all functions to the factory defaults, as they existed on delivery. To reset the piano to factory defaults, proceed as follows:

1. ▶ Switch off the device.
2. ▶ Keep *[REVERB]* and *[CHORUS]* simultaneously pressed and turn the piano on.
  - ⇒ All select button LEDs will now light up briefly when you hold down the two buttons. Once this is done, you can release *[REVERB]* and *[CHORUS]*. The piano is now in the normal mode (can be played normally). The LEDs on the control elements now show the original status according to the factory setting.

## 8 Functions

### 8.1 Playing demo songs

Press *[REVERB]* and *[CHORUS]* simultaneously to enter Demo song play mode. Use the select buttons to select the desired demo song.

Press *[REVERB]* and *[CHORUS]* again to stop playback.

### 8.2 Reverb and Chorus effects

The sound of the digital piano can be modified by the built-in Reverb and Chorus effect. Press *[REVERB]* or *[CHORUS]*.

### 8.3 Metronome

Press *[METRONOME]* to turn the Metronome on and off.

Proceed as follows to set the time signature:

1. ➤ Keep *[METRONOME]* and *[TEMPO]* pressed.
2. ➤ Use the piano key *[G#0]* to select the desired time signature: 2/2, 1/4, 2/4, 3/4, 4/4, 5/4, 6/4, 3/8, 6/8, 7/8, 9/8 or 12/8. Standard value is set to 4/4.
3. ➤ Press *[METRONOME]* and *[TEMPO]* to exit the Edit mode.

#### Setting the Metronome volume

Proceed as follows to adjust the volume:

1. ➤ Keep *[METRONOME]* and *[TEMPO]* pressed to enter Edit mode.
2. ➤ Press *[F#0]* to switch to the Volume menu for the main layer.
3. ➤ Now you can adjust the volume in 88 note steps from 0 – 127. *[C7]* corresponds to value 127 and *[A-1]* to value 0.
4. ➤ Press *[METRONOME]* and *[TEMPO]* to exit the Edit mode.

#### Setting the Tempo

Metronome tempo is adjustable from 20 to 280 beats per minute (BPM). For adjusting, proceed as follows:

1. ➤ Keep *[METRONOME]* and *[TEMPO]* pressed for 3 seconds to change the setting.
2. ➤ Press piano key *[G#0]* to select the tempo. For example, the piano key *[C3]* corresponds to 120 BPM.
3. ➤ Press *[METRONOME]* and *[TEMPO]* to exit the Edit mode. The LED goes out now.

### 8.4 Transposing

Use *[METRONOME]* and *[TEMPO]* to transpose the entire keyboard by twelve semi-tones up or down. Use *[D#2]* to call up the 'Transpose' function. Use the piano keys *[C2]* to *[C4]* to transpose the value range. The value of the piano key *[C3]* defaults.

### 8.5 Layer mode

In Layer mode, two voices can be played in parallel with the corresponding volume. Both can be selected with the direct select buttons.

Proceed as follows to adjust the Layer mode:

1. ➤ Keep the desired MAIN sound selection key pressed (e.g. *[GRAND PIANO]*).
2. ➤ Then press a second desired selection button to set a layer effect (e.g. *[STRINGS]*). Now the LEDs of both selection buttons light up once you release the button.

To layer two sounds on different banks:

1. ➤ Keep the desired selection button pressed (e.g. *[GRAND PIANO]*) and *[BANK]* at the same time. Once the *[BANK]* LED and the LED of the respective selection button light up, you can release the buttons.
2. ➤ Then press a second selection button (e.g. *[STRINGS]*) to get a layer effect on the second bank. The LEDs of the two function buttons light up blue now.

#### Setting the volume in main layer (Voice 1)

To adjust the volume in main layer proceed as follows:

1. ➤ Keep *[METRONOME]* and *[TEMPO]* pressed to enter Edit mode. The LEDs of the buttons *[METRONOME]* and *[TEMPO]* light up now.
2. ➤ Now you can adjust the volume in 88 note steps from 0 – 127. *[C7]* corresponds to value 127 and *[A-1]* to value 0.
3. ➤ Keep *[METRONOME]* and *[TEMPO]* pressed to exit the Edit mode.

#### Setting the volume of the layer voice (Voice 2)

To adjust the volume of the layer voice proceed as follows:

1. ➤ Keep *[METRONOME]* and *[TEMPO]* pressed to enter Edit mode. The LEDs of the buttons *[METRONOME]* and *[TEMPO]* light up now.
2. ➤ Press *[D#0]* to switch to the Volume menu for the tonal colours.
3. ➤ Now you can adjust the volume in 88 note steps from 0 – 127. *[C7]* corresponds to value 127 and *[A-1]* to value 0.
4. ➤ Keep *[METRONOME]* and *[TEMPO]* pressed to exit the Edit mode.

## 9 Troubleshooting

Problem	Possible causes and solutions
You hear a 'pop' sound from the speakers when switching the digital piano on and off.	This is normal. No need to worry.
No sound can be heard when playing the piano.	<p>Make sure that the volume control is set appropriately.</p> <p>Check if headphones are connected. Connecting headphones will mute the speakers of the digital piano.</p> <p>Check in the function menu that the built-in sound system is activated. On activating, the display shows '<i>Local On</i>'.</p>
Malfunction occurs when using a mobile phone.	Using a mobile phone near the digital piano can cause interference. To prevent this, turn off the mobile phone or use it only at a safe distance.

## 10 Technical specifications

Input connections	Power supply	Input socket for external power adapter
	USB port	USB-to-Host
	Sustain Pedal	1 × 1/4" jack socket
Output connections	Headphones	1 × 1/4" jack socket
	MIDI port	USB
	Line Out	2 × 1/4" jack socket
Keyboard	88 light weighted keys and adjustable touch velocity	
Polyphony	32-voice	
Tonal colours	12	
Effects	Reverb, Chorus	
Pedals	Sustain	
Demo and practice songs	12	
Speaker	2 × 20 W, 6 Ω	
Power supply	External power adapter, 100 - 240 V ~ 50/60 Hz	
Operating voltage	12 V $\pm$ 1000 mA, centre positive	
Battery / rechargeable battery	Battery type	6 × D cells, LR20
	Voltage	1.5 V
Dimensions (W × H × D)	1275 mm × 275 mm × 85 mm (without music stand)	
	1275 mm × 275 mm × 1000 mm (with music stand)	
Weight	9 kg	
Colour	Black, polished	
Ambient conditions	Temperature range	0 °C...40 °C
	Relative humidity	50 %, non-condensing

### Further information

Design	Black
Surface	Satined
Wooden keyboard	No
Ivory-feel keyboard	No

Auto Accompaniment	No
Number of rhythms	0
Storage medium	USB to host

## 11 MIDI implementation chart

Function		Sent	Received	Notes
Basic Channel	Default	1 – 16	1 – 16	up to 3 channels at a time
	Changed	1 – 16	1 – 16	
Mode	Default	Mode 3	Mode 3	
	Messages	Yes	No	
	Altered	*****	No	
Control Change		0 – 127	0,1, 5,6, 7, 10,11, 32, 64, 65, 66, 67, 80, 81, 91, 93, 100, 121	
Programme Change	True #	0 – 127 *****	0 – 11	12
System Exclusive		Yes*	Yes*	*the controller detects and responds to the GM device requests. Master Tune supported. Master Volume supported.
System Common	Song Position Pointer	No	No	
	Song Select	No	No	
	Tune Request	No	No	
System Real Time	Clock	No	No	
	Commands	No	No	
Aux Messages	All Sounds Off*	Yes	Yes	*the controller responds to the GM signal, but not to the piano voices
	Reset All Controllers	Yes	Yes	
	Local ON/OFF*	Yes	Yes	
	ALL Notes OFF	Yes	Yes	
	Active Sensing	No	Yes	
	System Reset	No	Yes	
Program Change		Yes 0 – 127	Yes 0 – 127	
	True	0 – 127	0 – 127	
		No	Yes	
System Common	Song Position Pointer	No	No	
	Song Select	No	No	



Function		Sent	Received	Notes
	Tune Request	No	No	
Aux Messages	LOCAL ON/OFF	Yes	Yes	
	All Notes Off	Yes	Yes	
	Active Sensing	No	Yes	
	System Reset	No	Yes	
Notes:				

**MIDI channel modes**

	POLY OFF	MONO ON
OMNI ON	Mode 1	Mode 2
OMNI OFF	Mode 3	Mode 4

## 12 Function button allocation

Select the value to be parameterised using the following table:

	Tuning	Voice Vol	Layer Vol	Metro.Vol	Reverb Vol	Chorus Vol	Tempo	Treble EQ	Bass EQ	Trans.
A-1	0	0	0	0	0	0	20	-12	-12	x
A#-1	3	2	2	2	2	2	24	x	x	x
B-1	5	4	4	4	4	4	28	-11	-11	x
C0	8	6	6	6	6	6	32	-10	-10	x
C#0	10	8	8	8	8	8	36	x	x	x
D0	13	10	10	10	10	10	40	40	-9	-9
D#0	15	12	12	12	12	12	44	x	x	x
E0	18	14	14	14	14	14	48	-8	-8	x
F0	20	16	16	16	16	16	52	-7	-7	x
F#0	23	18	18	18	18	18	56	x	x	x
G0	26	20	20	20	20	20	60	-6	-6	x
G#0	28	22	22	22	22	22	62	x	x	x
A0	29	24	24	24	24	24	64	-5	-5	x
A#0	31	26	26	26	26	26	66	x	x	x
B0	32	28	28	28	28	28	68	-4	-4	x
C1	33	30	30	30	30	30	70	-3	-3	x
C#1	35	32	32	32	32	32	72	x	x	x
D1	36	34	34	34	34	34	74	-2	-2	x
D#1	37	36	36	36	36	36	76	x	x	x
E1	38	38	38	38	38	38	80	-1	-1	x
F1	40	40	40	40	40	40	82	0	0	x
F#	41	42	42	42	42	42	84	x	x	x
G1	42	44	44	44	44	44	86	1	1	x
G#1	44	46	46	46	46	46	88	x	x	x

	<b>Tuning</b>	<b>Voice Vol</b>	<b>Layer Vol</b>	<b>Metro.Vol</b>	<b>Reverb Vol</b>	<b>Chorus Vol</b>	<b>Tempo</b>	<b>Treble EQ</b>	<b>Bass EQ</b>	<b>Trans.</b>
A1	45	48	48	48	48	48	90	2	2	×
A#1	46	50	50	50	50	50	92	×	×	×
B1	47	52	52	52	52	52	94	3	3	×
C2	49	54	54	54	54	54	96	4	4	-12
C#2	50	56	56	56	56	56	98	×	×	-11
D2	51	58	58	58	58	58	100	5	5	-10
D#2	52	60	60	60	60	60	102	×	×	-9
E2	54	62	62	62	62	62	104	6	6	-8
F2	55	64	64	64	64	64	106	7	7	-7
F#2	56	66	66	66	66	66	108	×	×	-6
G2	58	68	68	68	68	68	110	8	8	-5
G#2	59	70	70	70	70	70	112	×	×	-4
A2	60	72	72	72	72	72	114	9	9	-3
A#2	61	74	74	74	74	74	116	×	×	-2
B2	63	76	76	76	76	76	118	10	10	-1
C3	64	78	78	78	78	78	120	11	11	0
C#3	65	80	80	80	80	80	122	×	×	1
D3	67	81	81	81	81	81	124	12	12	2
D#3	68	82	82	82	82	82	126	×	×	3
E3	69	83	83	83	83	83	128	×	×	4
F3	70	84	84	84	84	84	130	×	×	5
F#3	72	85	85	85	85	85	132	×	×	6
G3	73	86	86	86	86	86	134	×	×	7
G#3	74	87	87	87	87	87	136	×	×	8
A3	76	88	88	88	88	88	138	×	×	9
A#3	77	89	89	89	89	89	140	×	×	10
B3	78	90	90	90	90	90	142	×	×	11
C4	79	91	91	91	91	91	144	×	×	12

## Function button allocation

	<b>Tuning</b>	<b>Voice Vol</b>	<b>Layer Vol</b>	<b>Metro. Vol</b>	<b>Reverb Vol</b>	<b>Chorus Vol</b>	<b>Tempo</b>	<b>Treble EQ</b>	<b>Bass EQ</b>	<b>Trans.</b>
C#4	81	92	92	92	92	92	146	×	×	×
D4	82	93	93	93	93	93	148	×	×	×
D#4	83	94	94	94	94	94	150	×	×	×
E4	84	95	95	95	95	95	152	×	×	×
F4	86	96	96	96	96	96	154	×	×	×
F#4	87	97	97	97	97	97	156	×	×	×
G4	88	98	98	98	98	98	158	×	×	×
G#4	90	99	99	99	99	99	160	×	×	×
A4	91	100	100	100	100	100	162	×	×	×
A#4	92	101	101	101	101	101	164	×	×	×
B4	93	102	102	102	102	102	166	×	×	×
C5	95	103	103	103	103	103	168	×	×	×
C#5	96	104	104	104	104	104	170	×	×	×
D5	97	105	105	105	105	105	172	×	×	×
D#5	99	106	106	106	106	106	174	×	×	×
E5	100	107	107	107	107	107	176	×	×	×
F5	101	108	108	108	108	108	178	×	×	×
F#5	102	109	109	109	109	109	180	×	×	×
G5	104	110	110	110	110	110	185	×	×	×
G#5	105	111	111	111	111	111	190	×	×	×
A5	106	112	112	112	112	112	195	×	×	×
A#5	108	113	113	113	113	113	200	×	×	×
B5	109	114	114	114	114	114	205	×	×	×
C6	110	115	115	115	115	115	210	×	×	×
C#6	111	116	116	116	116	116	215	×	×	×
D6	113	117	117	117	117	117	220	×	×	×
D#6	114	118	118	118	118	118	225	×	×	×
E6	115	119	119	119	119	119	230	×	×	×

	Tuning	Voice Vol	Layer Vol	Metro. Vol	Reverb Vol	Chorus Vol	Tempo	Treble EQ	Bass EQ	Trans.
F6	116	120	120	120	120	120	235	×	×	×
F#6	118	121	121	121	121	121	240	×	×	×
G6	119	122	122	122	122	122	245	×	×	×
G#6	120	123	123	123	123	123	250	×	×	×
A6	122	124	124	124	124	124	255	×	×	×
A#6	123	125	125	125	125	125	260	×	×	×
B6	125	126	126	126	126	126	270	×	×	×
C7	127	127	127	127	127	127	280	×	×	×



For the fields marked with 'X', no value is assigned in the Edit mode.

#### Reset values (factory defaults)

	Tune	Voice Vol	Layer Vol	Metro. Vol	Local	Channel	Tempo	Voice Select	Trans	Auto Power Off
Factory defaults	0	127	100	100	ON	1	120	1 (Grand Piano)	0	OFF

## 13 Protecting the environment

### Disposal of the packaging material



For the transport and protective packaging, environmentally friendly materials have been chosen that can be supplied to normal recycling.

Ensure that plastic bags, packaging, etc. are properly disposed of.

Do not just dispose these materials with your normal household waste, but make sure that they are fed to a recovery. Please follow the notes and markings on the packaging.

### Disposal of batteries



Batteries must not be disposed of as domestic waste or thrown into fire. Dispose of the batteries according to national or local regulations regarding hazardous waste. To protect the environment, dispose of empty batteries at your retail store or at appropriate collection sites.

### Disposal of your old device



This product is subject to the European Waste Electrical and Electronic Equipment Directive (WEEE) in its currently valid version. Do not dispose with your normal household waste.

Dispose this device through an approved waste disposal firm or through your local waste facility. When discarding the device, comply with the rules and regulations that apply in your country. If in doubt, consult your local waste disposal facility.



