



STAIRVILLE

Ignition LED PAR56
Floor WCA 36x1W
Floor WCA 36x1W

LED PAR

Musikhaus Thomann
Thomann GmbH
Hans-Thomann-Straße 1
96138 Burgebrach
Germany
Telephone: +49 (0) 9546 9223-0
E-mail: info@thomann.de
Internet: www.thomann.de

07.07.2017, ID: 390057, 268159

Table of contents

1	General notes	5
	1.1 Further information.....	6
	1.2 Notational conventions.....	7
	1.3 Symbols and signal words.....	7
2	Safety instructions	10
3	Features	15
4	Installation	16
5	Starting up	19
6	Connections and controls	21
7	Operating	23
	7.1 Starting the device.....	23
	7.2 System settings.....	23
	7.3 Auto mode.....	25
	7.4 DMX operation.....	25
	7.5 Menu overview.....	29

7.6	Functions in 1-channel DMX mode.....	31
7.7	Functions in 2-channel DMX mode.....	31
7.8	Functions in 3-channel DMX mode.....	32
7.9	Functions in 5-channel DMX mode.....	33
7.10	Functions in 7-channel DMX mode.....	35
7.11	Functions in 8-channel DMX mode.....	39
8	Technical specifications.....	41
9	Plug and connection assignments.....	43
10	Troubleshooting.....	44
11	Cleaning.....	46
12	Protecting the environment.....	47

1 General notes

This manual contains important instructions for the safe operation of the unit. Read and follow the safety instructions and all other instructions. Keep the manual for future reference. Make sure that it is available to all those using the device. If you sell the unit please make sure that the buyer also receives this manual.

Our products are subject to a process of continuous development. Thus, they are subject to change.

1.1 Further information

On our website (www.thomann.de) you will find lots of further information and details on the following points:

Download	This manual is also available as PDF file for you to download.
Keyword search	Use the search function in the electronic version to find the topics of interest for you quickly.
Online guides	Our online guides provide detailed information on technical basics and terms.
Personal consultation	For personal consultation please contact our technical hotline.
Service	If you have any problems with the device the customer service will gladly assist you.

1.2 Notational conventions

This manual uses the following notational conventions:

Letterings

The letterings for connectors and controls are marked by square brackets and italics.

Examples: *[VOLUME]* control, *[Mono]* button.



Displays

Texts and values displayed on the device are marked by quotation marks and italics.

Examples: *'24ch'*, *'OFF'*.

1.3 Symbols and signal words

In this section you will find an overview of the meaning of symbols and signal words that are used in this manual.

Signal word	Meaning
DANGER!	This combination of symbol and signal word indicates an immediate dangerous situation that will result in death or serious injury if it is not avoided.
WARNING!	This combination of symbol and signal word indicates a possible dangerous situation that can result in death or serious injury if it is not avoided.
NOTICE!	This combination of symbol and signal word indicates a possible dangerous situation that can result in material and environmental damage if it is not avoided.
Warning signs	Type of danger
	Warning – high-voltage.
	Warning – suspended load.

Warning signs	Type of danger
	Warning – danger zone.

2 Safety instructions

Intended use

This device is intended to be used as an electronic illumination effect using LED technics. The device is designed for professional use and is not suitable for use in households. Use the device only as described in this user manual. Any other use or use under other operating conditions is considered to be improper and may result in personal injury or property damage. No liability will be assumed for damages resulting from improper use.

This device may be used only by persons with sufficient physical, sensorial, and intellectual abilities and having corresponding knowledge and experience. Other persons may use this device only if they are supervised or instructed by a person who is responsible for their safety.

Safety**DANGER!****Danger for children**

Ensure that plastic bags, packaging, etc. are disposed of properly and are not within reach of babies and young children. Choking hazard!

Ensure that children do not detach any small parts (e.g. knobs or the like) from the unit. They could swallow the pieces and choke!

Never let children unattended use electrical devices.

**DANGER!****Electric shock caused by high voltages inside**

Within the device there are areas where high voltages may be present. Never remove any covers.

There are no user-serviceable parts inside.

Do not use the device if covers, protectors or optical components are missing or damaged.



DANGER!

Electric shock caused by short-circuit

Do not modify the mains cable or the plug. Failure to do so could result in electric shock/death or fire. If in doubt, seek advice from a registered electrician.



WARNING!

Eye damage caused by high light intensity

Never look directly into the light source.



WARNING!

Risk of epileptic shock

Strobe lighting can trigger seizures in photosensitive epilepsy. Sensitive persons should avoid looking at strobe lights.



NOTICE!

Risk of fire

Do not block areas of ventilation. Do not install the device near any direct heat source. Keep the device away from naked flames.



NOTICE!

Operating conditions

This device has been designed for indoor use only. To prevent damage, never expose the device to any liquid or moisture. Avoid direct sunlight, heavy dirt, and strong vibrations.



NOTICE!

Power supply

Before connecting the device, ensure that the input voltage (AC outlet) matches the voltage rating of the device and that the AC outlet is protected by a residual current circuit breaker. Failure to do so could result in damage to the device and possibly injure the user.

Unplug the device before electrical storms occur and when it is unused for long periods of time to reduce the risk of electric shock or fire.

3 Features

The LED PAR is suitable for almost all applications, for example in clubs, bars, small stages and theatres. It is characterized by small size, solid construction also for use 'on tour' and enormous power.

Special features of the device:

- 36 × RGB LEDs, each 1 W (model Ignition LED PAR56 Floor RGB)
or
- 36 × WCA LEDs, each 1 W (model Ignition LED PAR56 Floor WCA)
- Control via DMX (six different modes) and via buttons and display on the unit
- Automatic mode and sound control
- Master / Slave operation
- Percental stepless colour mixing
- Extended fanless temperature control
- Robust metal housing with double bracket

4 Installation

Unpack and carefully check that there is no transportation damage before using the unit. Keep the equipment packaging. To fully protect the device against vibration, dust and moisture during transportation or storage use the original packaging or your own packaging material suitable for transport or storage, respectively.

You can install the device on the wall, ceiling or floor. A two-piece mounting bracket with locking screws is included in the package.



WARNING!

Risk of injury caused by falling objects

Make sure that the installation complies with the standards and rules that apply in your country. Always secure the device with a secondary safety attachment, such as a safety cable or a safety chain.



NOTICE!

Risk of overheating

Always ensure sufficient ventilation.

The ambient temperature must always be below 40 °C (104 °F).



NOTICE!

Use of stands

When mounting the device onto a stand, ensure that the stand is in a safe and stable position and that the weight of the device does not exceed the maximum permissible load capacity of the stand.



NOTICE!

Possible data transmission errors

For error-free operation make use of dedicated DMX cables and do not use ordinary microphone cables.

Never connect the DMX input or output to audio devices such as mixers or amplifiers.

5 Starting up

Create all connections while the device is off. Use the shortest possible high-quality cables for all connections. Take care when running the cables to prevent tripping hazards.

Connections in DMX mode

Connect the DMX input of the device to the DMX output of a DMX controller or another DMX device. Connect the output of the first DMX device to the input of the second one, and so on to form a daisy chain. Always ensure that the output of the last DMX device in the daisy chain is terminated with a resistor ($110\ \Omega$, $\frac{1}{4}\text{ W}$).

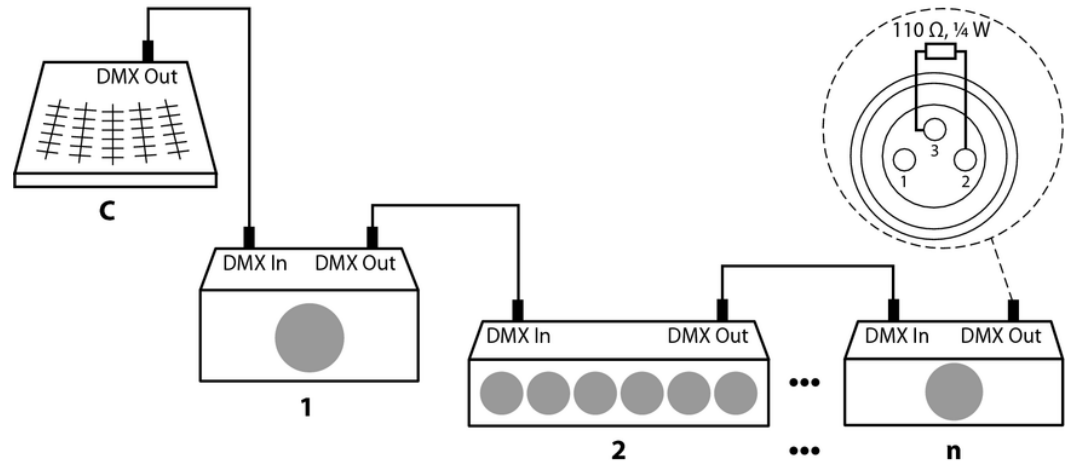

6 Connections and controls

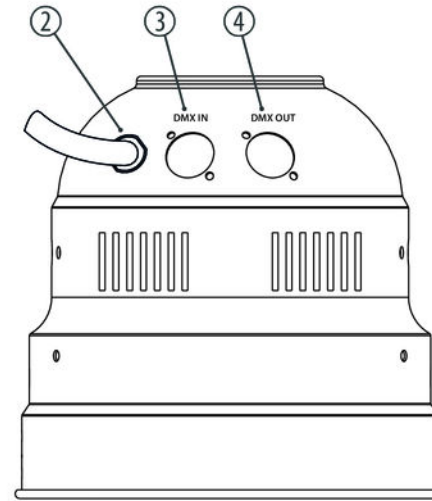
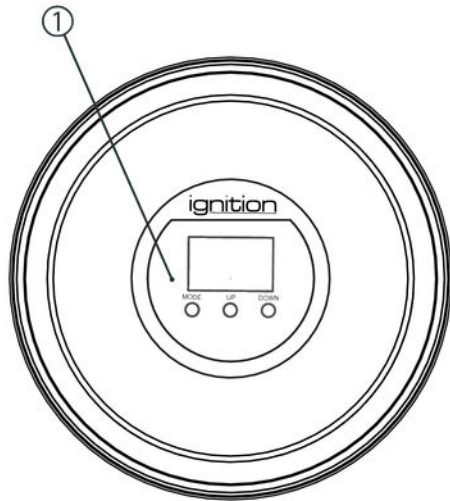

Ignition LED PAR56 Floor WCA 36x1W Floor WCA 36x1W

1	Display and function buttons.
	<i>[MODE]</i> Opens the main menu and confirms a selected value.
	<i>[UP]</i> Increases the displayed value by one.
	<i>[DOWN]</i> Decreases the displayed value by one.
2	Power cord
3	<i>[DMX IN]</i> DMX input.
4	<i>[DMX OUT]</i> DMX output

7 Operating

7.1 Starting the device

Connect the device to the power supply to start operation.

7.2 System settings

Display off

Press *[MODE]* until the display shows 'SETUP DISP'. Use *[UP]* or *[DOWN]* to select one of the following options:

- 'ON': Display remains permanently on during operation.
- 'OFF': Display is switched off 10 seconds after the last setting.

Setting the dimmer

Press *[MODE]* until the display shows 'SETUP DIM'. Adjust the dimmer function with *[UP]* or *[DOWN]* in a range from 0 % ... 100 %.

Setting the colour intensity, Ignition LED PAR56 Floor WCA

Press *[MODE]* until the display shows 'COLORSET'. Use *[UP]* or *[DOWN]* to select one of the following options:

- 'WW': Use *[UP]* or *[DOWN]* to adjust the colour Warm White in a range from 0 % ... 100 %.
- 'CW': Use *[UP]* or *[DOWN]* to adjust the colour Cold White in a range from 0 % ... 100 %.
- 'AMB': Use *[UP]* or *[DOWN]* to adjust the colour Amber in a range from 0 % ... 100 %.

Setting the colour intensity, Ignition LED PAR56 Floor RGB

Press *[MODE]* until the display shows 'COLORSET'. Use *[UP]* or *[DOWN]* to select one of the following options:

- 'RED': Use *[UP]* or *[DOWN]* to adjust the colour Red in a range from 0 % ... 100 %.
- 'GRE': Use *[UP]* or *[DOWN]* to adjust the colour Green in a range from 0 % ... 100 %.
- 'BLU': Use *[UP]* or *[DOWN]* to adjust the colour Blue in a range from 0 % ... 100 %.

Reset to factory defaults

Press *[MODE]* until the display shows 'RESET'. Simultaneously press the function buttons *[UP]* and *[DOWN]* to reset the device to the factory default settings.

7.3 Auto mode

Auto mode gives you the option to select one of eight preprogrammed shows.

Press *[MODE]* until the display shows 'Program'. Use *[UP]* or *[DOWN]* to select one of the pre-programmed shows 001 ... 008.

7.4 DMX operation

Setting the DMX address

Press *[MODE]* until the display shows 'DMX ADD'.

Now you can set the number of the first DMX channel to be used by the device (DMX address). Use *[UP]* or *[DOWN]* to select a value between 1 and 512 (the display shows 'A001' ... 'A512').

Make sure that this number matches the configuration of your DMX controller. The following table shows the highest possible DMX address for the various DMX modes.

Mode	Highest possible DMX address
1-channel	512
2-channel	511
3-channel	510
5-channel	508
7-channel	506
8-channel (only model Ignition LED PAR56 Floor WCA)	505

Selecting the DMX mode, Ignition LED PAR56 Floor WCA

Press *[MODE]* until the display shows 'DMX'.

With *[UP]* or *[DOWN]* you can now select one of the following DMX modes:

- 'MODE 1' (one channel)
- 'MODE 2' (two channels)
- 'MODE 3' (three channels)
- 'MODE 4' (five channels)
- 'MODE 5' (seven channels)
- 'MODE 6' (eight channels)
- 'SLAVE' (Slave operation)

This setting is only relevant when the device is controlled via DMX.

Selecting the DMX mode, Ignition LED PAR56 Floor RGB

Press *[MODE]* until the display shows '*DMX*'.

With *[UP]* or *[DOWN]* you can now select one of the following DMX modes:

- '*MODE 1*' (one channel)
- '*MODE 2*' (two channels)
- '*MODE 3*' (three channels)
- '*MODE 4*' (five channels)
- '*MODE 5*' (seven channels)
- '*MODE 6*' (seven channels)
- '*SLAVE*' (Slave operation)

This setting is only relevant when the device is controlled via DMX.

7.5 Menu overview

Ignition LED PAR56 Floor WCA

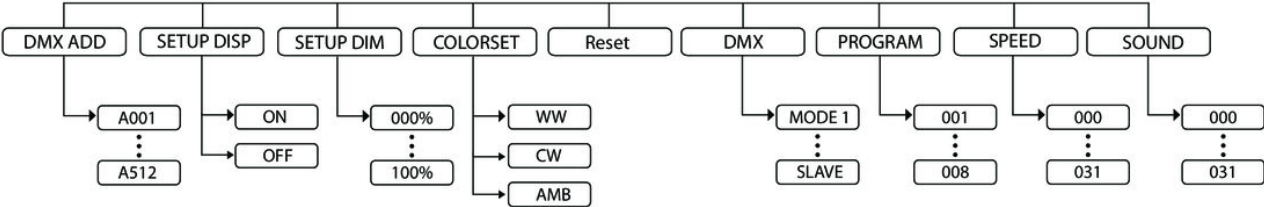

Ignition LED PAR56 Floor RGB

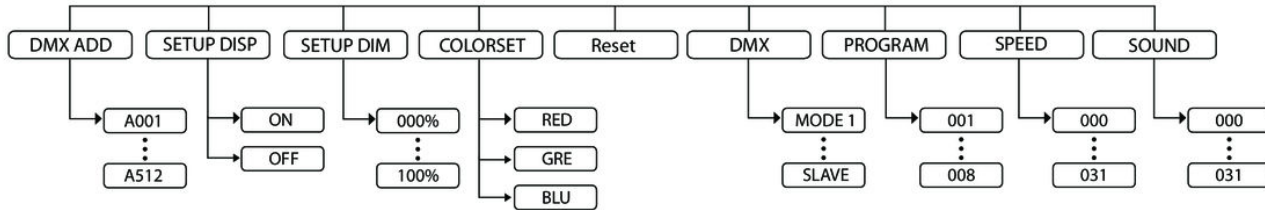

7.6 Functions in 1-channel DMX mode

DMX mode 1

Channel	Value	Function
1	0...255	Selecting colour macros 1 ... 32

7.7 Functions in 2-channel DMX mode

DMX mode 2

Channel	Value	Function
1	0...255	Selecting colour macros 1 ... 32
2	0...255	Dimmer function (0 % bis 100 %)

7.8 Functions in 3-channel DMX mode

Ignition LED PAR56 Floor WCA, DMX mode 3

Channel	Value	Function
1	0...255	Intensity warm white (0 % to 100 %)
2	0...255	Intensity cold white (0 % to 100 %)
3	0...255	Intensity amber (0 % to 100 %)

Ignition LED PAR56 Floor RGB, DMX mode 3

Channel	Value	Function
1	0...255	Intensity red (0 % to 100 %)
2	0...255	Intensity green (0 % to 100 %)
3	0...255	Intensity blue (0 % to 100 %)

7.9 Functions in 5-channel DMX mode

Ignition LED PAR56 Floor WCA, DMX mode 4

Channel	Value	Function
1	0...255	Intensity warm white (0 % to 100 %)
2	0...255	Intensity cold white (0 % to 100 %)
3	0...255	Intensity amber (0 % to 100 %)
4	0...255	Stroboscope effect (0 % to 100 %)
5	0...255	Dimmer function (0 % bis 100 %)

**Ignition LED PAR56 Floor RGB,
DMX mode 4**

Channel	Value	Function
1	0...255	Intensity red (0 % to 100 %)
2	0...255	Intensity green (0 % to 100 %)
3	0...255	Intensity blue (0 % to 100 %)
4	0...255	Stroboscope effect (0 % to 100 %)
5	0...255	Dimmer function (0 % to 100 %)

7.10 Functions in 7-channel DMX mode

Ignition LED PAR56 Floor WCA, DMX mode 5

Channel	Value	Function
1	0...255	Intensity warm white (0 % to 100 %)
2	0...255	Intensity cold white (0 % to 100 %)
3	0...255	Intensity amber (0 % to 100 %)
4	0...255	Stroboscope effect (0 % to 100 %)
5	0...255	Dimmer function (0 % to 100 %)
6	0...31	No function
	32...63	Dimmer effect, dark / bright
	64...95	Dimmer effect, bright / dark
	96...127	Dimmer effect, dark / bright / dark
	128...159	Colour change with fade effect

Channel	Value	Function
	160...191	Colour change with three colours
	192...223	Colour change with seven colours
	224...255	Sound control
7	0...255	Speed channel 6, increasing

Ignition LED PAR56 Floor RGB, DMX mode 5

Channel	Value	Function
1	0...255	Intensity red (0 % to 100 %)
2	0...255	Intensity green (0 % to 100 %)
3	0...255	Intensity blue (0 % to 100 %)
4	0...255	Stroboscope effect (0 % to 100 %)
5	0...255	Dimmer function (0 % to 100 %)

Channel	Value	Function
6	0...31	No function
	32...63	Dimmer effect, dark / bright
	64...95	Dimmer effect, bright / dark
	96...127	Dimmer effect, dark / bright / dark
	128...159	Colour change with fade effect
	160...191	Colour change with three colours
	192...223	Colour change with seven colours
	224...255	Sound control
7	0...255	Speed channel 6, increasing

**Ignition LED PAR56 Floor RGB,
DMX mode 6**

Channel	Value	Function
1	0...255	Intensity red (0 % to 100 %)
2	0...255	Intensity green (0 % to 100 %)
3	0...255	Intensity blue (0 % to 100 %)
4	0...255	Selecting colour macros 1 ... 32
5	0...255	Stroboscope effect (0 % to 100 %)
6	0...31	No function
	32...63	Dimmer effect, dark / bright
	64...95	Dimmer effect, bright / dark
	96...127	Dimmer effect, dark / bright / dark
	128...159	Colour change with fade effect
	160...191	Colour change with three colours

Channel	Value	Function
	192...223	Colour change with seven colours
	224...255	Sound control
7	0...255	Dimmer function (0 % to 100 %)

7.11 Functions in 8-channel DMX mode

Ignition LED PAR56 Floor WCA, DMX mode 6

Channel	Value	Function
1	0...255	Intensity warm white (0 % to 100 %)
2	0...255	Intensity cold white (0 % to 100 %)
3	0...255	Intensity amber (0 % to 100 %)
4		No function

Channel	Value	Function
5	0...255	Selecting colour macros 1 ... 32
6	0...255	Stroboscope effect (0 % to 100 %)
7	0...31	No function
	32...63	Dimmer effect, dark / bright
	64...95	Dimmer effect, bright / dark
	96...127	Dimmer effect, dark / bright / dark
	128...159	Colour change with fade effect
	160...191	Colour change with three colours
	192...223	Colour change with seven colours
	224...255	Sound control
8	0...255	Dimmer function (0 % to 100 %)

8 Technical specifications

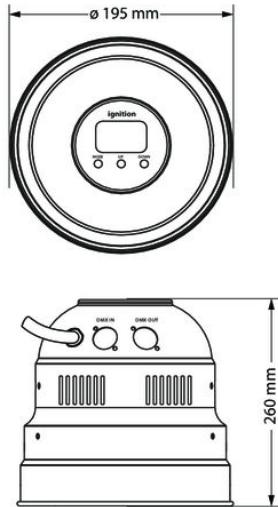

	Ignition LED PAR56 Floor WCA 36x1W	Ignition LED PAR56 Floor RGB 36x1W
LEDs	36 × WCA, each 1 W	36 × RGB, each 1 W
Beam angle	25°	
Number of DMX channels	1, 2, 3, 5, 7, 8	1, 2, 3, 5, 7, 7
Modulation	500 Hz	
Colour temperature	3200 K / 6500 K	
Power consumption	55 W	
Operating supply voltage	AC 100 – 240 V ~ 50/60 Hz	
Dimensions	195 × 230 × 260 mm (W × H × D, incl. bracket)	

Ignition LED PAR56 Floor WCA 36x1W Floor WCA 36x1W

	Ignition LED PAR56 Floor WCA 36×1W	Ignition LED PAR56 Floor RGB 36×1W
	195 × 260 mm (Ø × D, without bracket)	
Weight	2 kg	

9 Plug and connection assignments

Introduction

This chapter will help you select the right cables and plugs to connect your valuable equipment so that a perfect light experience is guaranteed.

Please take our tips, because especially in 'Sound & Light' caution is indicated: Even if a plug fits into a socket, the result of an incorrect connection may be a destroyed DMX controller, a short circuit or 'just' a not working light show!

DMX connections



The unit offers a 3-pin XLR socket for DMX output and a 3-pin XLR plug for DMX input. Please refer to the drawing and table below for the pin assignment of a suitable XLR plug.

Pin	Configuration
1	Ground, shielding
2	Signal inverted (DMX-, 'cold signal')
3	Signal (DMX+, 'hot signal')

10 Troubleshooting



NOTICE!

Possible data transmission errors

For error-free operation make use of dedicated DMX cables and do not use ordinary microphone cables.

Never connect the DMX input or output to audio devices such as mixers or amplifiers.

In the following we list a few common problems that may occur during operation. We give you some suggestions for easy troubleshooting:

Symptom	Remedy
The unit does not work, no light	Check the mains connection and the main fuse.
Apparently no function despite proper power supply	Check if the unit is in DMX mode or in 'slave' mode. If so, check the unit in another mode.
No response to the DMX controller	1. Check the address settings and the DMX polarity.
	2. Try using another DMX controller.
	3. Check whether the DMX cables run near or parallel to high-voltage cables that may cause damage or interference to a DMX interface circuit.

If the procedures recommended above do not succeed, please contact our Service Center. You can find the contact information at www.thomann.de.

11 Cleaning

Optical lenses

Clean the optical lenses, that are accessible from the outside, regularly in order to optimize the light output. The frequency of cleaning depends on the operating environment: wet, smoky or particularly dirty surroundings can cause more accumulation of dirt on the optics of the device.

- Clean with a soft cloth using our lamp and lens cleaner (item no. 280122).
- Always dry the parts carefully.

Fan grids

The fan grids of the device must be cleaned on a regular basis to remove dust and dirt. Before cleaning, switch off the device and disconnect AC-powered devices from the mains. Use a lint-free damp cloth for cleaning. Never use solvents or alcohol for cleaning.

12 Protecting the environment

Disposal of the packaging material



For the transport and protective packaging, environmentally friendly materials have been chosen that can be supplied to normal recycling.

Ensure that plastic bags, packaging, etc. are properly disposed of.

Do not just dispose of these materials with your normal household waste, but make sure that they are collected for recycling. Please follow the notes and markings on the packaging.

Disposal of your old device



This product is subject to the European Waste Electrical and Electronic Equipment Directive (WEEE). Do not dispose with your normal household waste.

Dispose of this device through an approved waste disposal firm or through your local waste facility. When discarding the device, comply with the rules and regulations that apply in your country. If in doubt, consult your local waste disposal facility.

Ignition LED PAR56 Floor WCA 36×1W Floor WCA 36×1W



