



furgeneration

LED Pot 12×1W
QCL RGB WW 15°,
LED Pot 12×1W
QCL RGB WW 40°

LED PAR

Musikhaus Thomann
Thomann GmbH
Hans-Thomann-Straße 1
96138 Burgebrach
Germany
Telephone: +49 (0) 9546 9223-0
E-mail: info@thomann.de
Internet: www.thomann.de

14.01.2020, ID: 409499, 428047 (V3)

Table of contents

1	General information	5
	1.1 Further information.....	6
	1.2 Notational conventions.....	7
	1.3 Symbols and signal words.....	8
2	Safety instructions	10
3	Features	16
4	Installation	18
5	Starting up	22
6	Connections and controls	25
7	Operating	31
	7.1 Operating mode Auto.....	31
	7.2 Program mode.....	32
	7.3 Operating mode DMX.....	35
	7.4 Operating mode Slave.....	41
	7.5 Operating mode Dimmer.....	41

7.6	Sound control.....	42
7.7	Reset to factory defaults.....	42
7.8	Device info.....	43
7.9	Menu overview.....	44
8	Technical specifications.....	45
9	Plug and connection assignments.....	48
10	Troubleshooting.....	49
11	Cleaning.....	51
12	Protecting the environment.....	52

1 General information

This user manual contains important information on the safe operation of the device. Read and follow all safety notes and all instructions. Save this manual for future reference. Make sure that it is available to all persons using this device. If you sell the device to another user, be sure that they also receive this manual.

Our products and user manuals are subject to a process of continuous development. We therefore reserve the right to make changes without notice. Please refer to the latest version of the user manual which is ready for download under www.thomann.de.

1.1 Further information

On our website (www.thomann.de) you will find lots of further information and details on the following points:

Download	This manual is also available as PDF file for you to download.
Keyword search	Use the search function in the electronic version to find the topics of interest for you quickly.
Online guides	Our online guides provide detailed information on technical basics and terms.
Personal consultation	For personal consultation please contact our technical hotline.
Service	If you have any problems with the device the customer service will gladly assist you.

1.2 Notational conventions

This manual uses the following notational conventions:

Letterings

The letterings for connectors and controls are marked by square brackets and italics.

Examples: *[VOLUME]* control, *[Mono]* button.

Instructions

The individual steps of an instruction are numbered consecutively. The result of a step is indented and highlighted by an arrow.





Example:

1. ➤ Switch on the device.
2. ➤ Press *[Auto]*.
 - ⇒ Automatic operation is started.
3. ➤ Switch off the device.

1.3 Symbols and signal words

In this section you will find an overview of the meaning of symbols and signal words that are used in this manual.

Signal word	Meaning
DANGER!	This combination of symbol and signal word indicates an immediate dangerous situation that will result in death or serious injury if it is not avoided.
WARNING!	This combination of symbol and signal word indicates a possible dangerous situation that can result in death or serious injury if it is not avoided.
NOTICE!	This combination of symbol and signal word indicates a possible dangerous situation that can result in material and environmental damage if it is not avoided.

Warning signs	Type of danger
	Warning – high-voltage.
	Warning – dangerous optical radiation.
	Warning – suspended load.
	Warning – danger zone.

2 Safety instructions

Intended use

This device is intended for use as an electronic lighting effect by means of LED technology. The device is designed for professional use and is not suitable for use in households. Use the device only as described in this user manual. Any other use or use under other operating conditions is considered to be improper and may result in personal injury or property damage. No liability will be assumed for damages resulting from improper use.

This device may be used only by persons with sufficient physical, sensorial, and intellectual abilities and having corresponding knowledge and experience. Other persons may use this device only if they are supervised or instructed by a person who is responsible for their safety.

Extend the life of the device by regular breaks in operation and avoid switching it on and off frequently. This device is not suitable for continuous use.

Safety**DANGER!****Danger for children**

Ensure that plastic bags, packaging, etc. are disposed of properly and are not within reach of babies and young children. Choking hazard!

Ensure that children do not detach any small parts (e.g. knobs or the like) from the unit. They could swallow the pieces and choke!

Never let children unattended use electrical devices.

**DANGER!****Electric shock caused by high voltages inside**

Within the device there are areas where high voltages may be present. Never remove any covers.

There are no user-serviceable parts inside.

Do not use the device if covers, protectors or optical components are missing or damaged.



DANGER!

Electric shock caused by short-circuit

Do not modify the mains cable or the plug. Failure to do so could result in electric shock/death or fire. If in doubt, seek advice from a registered electrician.



WARNING!

Eye damage caused by high light intensity

Never look directly into the light source.



WARNING!

Risk of epileptic shock

Strobe lighting can trigger seizures in photosensitive epilepsy. Sensitive persons should avoid looking at strobe lights.



NOTICE!

Risk of fire

Do not block areas of ventilation. Do not install the device near any direct heat source. Keep the device away from naked flames.



NOTICE!

Operating conditions

This device has been designed for indoor use only. To prevent damage, never expose the device to any liquid or moisture. Avoid direct sunlight, heavy dirt, and strong vibrations.

Only operate the device within the ambient conditions specified in the chapter 'Technical specifications' of this user manual. Avoid heavy temperature fluctuations and do not switch the device on immediately after it was exposed to temperature fluctuations (for example after transport at low outside temperatures).

Dust and dirt inside can damage the unit. When operated in harmful ambient conditions (dust, smoke, nicotine, fog, etc.), the unit should be maintained by qualified service personnel at regular intervals to prevent overheating and other malfunction.



NOTICE!

Power supply

Before connecting the device, ensure that the input voltage (AC outlet) matches the voltage rating of the device and that the AC outlet is protected by a residual current circuit breaker. Failure to do so could result in damage to the device and possibly injure the user.

Unplug the device before electrical storms occur and when it is unused for long periods of time to reduce the risk of electric shock or fire.

3 Features

Compact multicolour LED spotlight, especially suitable for use in installations and systems with limited space

- 12 × QCL-LEDs RGBWW (each 1 watt)
- Control via DMX, buttons and display on the unit and also infrared remote control
- 14 preprogrammed automatic shows
- Operating modes:
 - Sound control
 - Automatic mode
 - Programme mode
 - Master/Slave
 - DMX
- Compact plastic housing
- Two-piece mounting bracket
- Optionally available accessories: Infrared remote control, transport bag for four LED spotlights

For technological reasons, the light output of LEDs decreases over their lifetime. This effect increases with higher operating temperature. You can extend the service life of the illuminants by providing adequate ventilation and operating the LEDs with the lowest possible brightness.

4 Installation

Unpack and check carefully there is no transportation damage before using the unit. Keep the equipment packaging. To fully protect the product against vibration, dust and moisture during transportation or storage use the original packaging or your own packaging material suitable for transport or storage, respectively.



WARNING!

Risk of injury caused by falling objects

Make sure that the installation complies with the standards and rules that apply in your country. Always secure the device with a secondary safety attachment, such as a safety cable or a safety chain.



NOTICE!

Risk of overheating

The distance between light output and the illuminated surface must be more than 1.5 m (19.7in).

Provide sufficient ventilation.

The ambient temperature must always be below 40 °C (104 °F).



NOTICE!

Use of stands

When mounting the device onto a stand, ensure that the stand is in a safe and stable position and that the weight of the device does not exceed the maximum permissible load capacity of the stand.



NOTICE!

Possible data transmission errors

For error-free operation make use of dedicated DMX cables and do not use ordinary microphone cables.

Never connect the DMX input or output to audio devices such as mixers or amplifiers.

Mounting options

You can install the unit in hanging or standing position. When in use, the device must always be attached to a solid surface or an approved truss. Use the openings provided on the two-piece bracket for attaching.

Always work from a stable platform whenever installing, moving or servicing the unit. In doing so, the area underneath the unit must be cordoned off.

The safety cable must be attached to the bracket.



Please note that this device must not be connected to a dimmer.

5 Starting up

Create all connections while the device is off. Use the shortest possible high-quality cables for all connections. Take care when running the cables to prevent tripping hazards.

Connections in DMX mode

Connect the DMX input of the device to the DMX output of a DMX controller or another DMX device. Connect the output of the first DMX device to the input of the second one, and so on to form a daisy chain. Always ensure that the output of the last DMX device in the daisy chain is terminated with a resistor ($110\ \Omega$, $\frac{1}{4}\ \text{W}$).

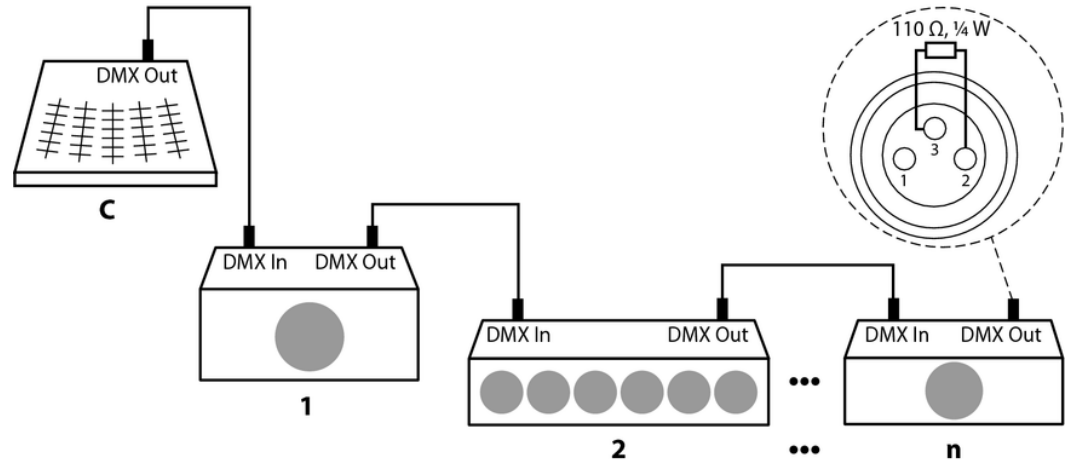

Connections in master/slave mode

When you configure a group of devices in master/slave mode, the first unit will control the other units for an automatic, sound-activated, synchronized show. This function is ideal when you want to start a show immediately. Connect the DMX output of the master device to the DMX input of the first slave device. Then connect the DMX output of the first slave device to the DMX input of the second slave device and so on.

6 Connections and controls

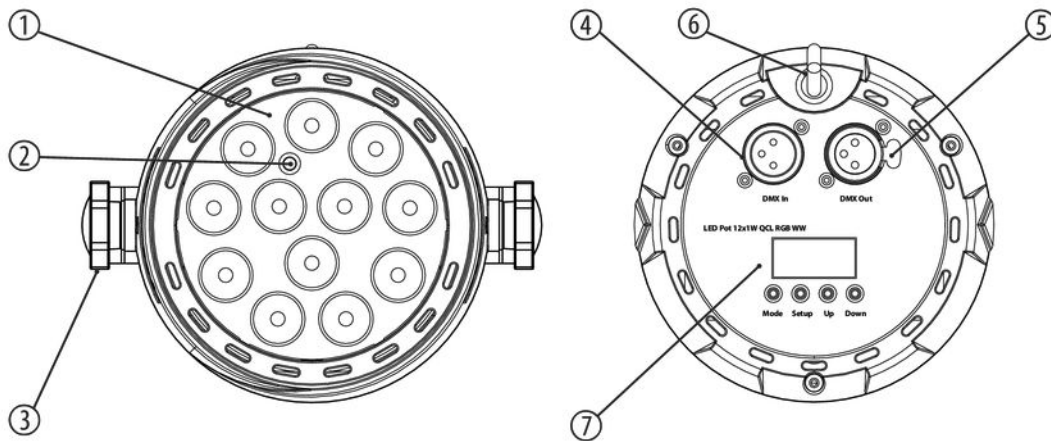

LED Pot 12×1W QCL RGB WW 15°, LED Pot 12×1W QCL RGB WW 40°

1	LEDs
2	Infrared sensor for receiving signals from the optionally available remote control.
3	Locking screws for the two-piece bracket.
4	<i>[DMX IN]</i> DMX input
5	<i>[DMX OUT]</i> DMX output
6	Power cord
7	Display and function buttons. <i>[Mode]</i> Opens the main menu or a submenu. <i>[Setup]</i> Confirms a selected value.

[Down]

Decreases the displayed value by one.

[Up]

Increases the displayed value by one.

Remote control (optional)

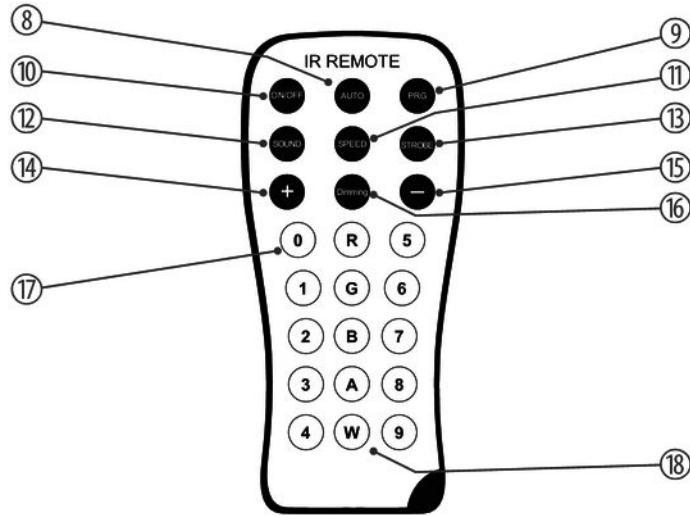

8	<i>[AUTO]</i> Enables the auto mode.
9	<i>[PRG]</i> Enables the Programme mode. Select the desired programme with the buttons <i>[+]</i> and <i>[-]</i> .
10	<i>[ON/OFF]</i> Activates / deactivates the device.
11	<i>[SPEED]</i> Activates the setting mode for the programme speed. Adjust the speed using the buttons <i>[+]</i> and <i>[-]</i> .
12	<i>[SOUND]</i> Activates the sound control.
13	<i>[STROBE]</i> Turns the strobe function on / off.
14	<i>[+]</i> Increases the set value.

15	<i>[-]</i> Decreases the set value.
16	<i>[Dimming]</i> Enables the dimmer function.
17	<i>[0 ... 9]</i> Numeric buttons for direct selection of a fixed colour.
18	<i>[R], [G], [B], [A], [W]</i> Buttons to select a colour tone for the dimmer mode.

7 Operating

Connect the device to the power supply to start operation. After a few seconds the unit is ready for use.

Press *[Mode]* or *[Up]* | *[Down]* to activate the main menu and select a menu option. Open the individual menus with *[Setup]* and change each displayed value with *[Up]* | *[Down]*. Changed values and settings will immediately take effect. Press *[Mode]* to return to the previous menu.

7.1 Operating mode Auto

Automatic operation can only be activated when the unit is operating in stand alone mode or as master in a master / slave combination. This setting takes effect only when the device is not operated under DMX control.

Press *[Mode]* or *[Up]* | *[Down]* repeatedly until the display shows 'AUTO'. The device now operates in automatic stand-alone mode, the programs 'Pr.02' ... 'Pr.14' run consecutively at the set program sequence speed.

7.2 Program mode

A preprogrammed automatic show can only be activated when the unit is operating in stand-alone mode or as master in a master / slave combination. This setting takes effect only when the device is not operated under DMX control.

Press *[Mode]* or *[Up]* | *[Down]* repeatedly until the display shows 'Pro'. Press *[Setup]* and use *[Up]* | *[Down]* to select one of the programs 'Pr.01' ... 'Pr.14'.

Settings for program 01

If you have selected program 01, you can use *[Up]* | *[Down]* to select one of 15 static colour settings, see the following table.

Colour	Display
Blackout	'00'
Red	'01'
Green	'02'
Blue	'03'
White	'04'
Amber	'05'
Orange	'06'
Yellow	'07'
Purple	'08'
Pink	'09'

Colour	Display
Cyan	'10'
Bright red	'11'
Bright green	'12'
Bright blue	'13'
Warm white	'14'
Cold white	'15'

Settings for programmes 02 ... 14

When you have selected one of programmes 02 ... 14 you can adjust the following settings:

1. ➤ After selecting the program, press *[Setup]* again and set the program sequence speed with *[Up]* | *[Down]* in the range from '001' ... '100' (slow ... fast).
2. ➤ Press *[Setup]* again and set the flashing speed for the strobe function with *[Up]* | *[Down]* in the range from '001' ... '100' (slow ... fast).

7.3 Operating mode DMX

This setting is only relevant if the device is controlled via a DMX controller.

1. ▶ Use *[Mode]* or *[Up]* | *[Down]* to select the menu option 'd---' and confirm this with *[Setup]*.
2. ▶ Use *[Up]* | *[Down]* to assign a DMX address in a range from 'd.001' ... 'd.512' to the device and confirm with *[Setup]*.
3. ▶ Press *[Up]* | *[Down]* to select the desired DMX mode:

Mode	Highest possible DMX address
4 channel	509
6 channel	507
8 channel	505

4. ▶ Confirm with *[Setup]*.

7.3.1 Functions in 4-channel DMX mode

Channel	Value	Function
1	0 ... 255	Intensity red (0 % to 100 %)
2	0 ... 255	Intensity green (0 % to 100 %)
3	0 ... 255	Intensity blue (0 % to 100 %)
4	0 ... 255	Intensity white (0 % to 100 %)

7.3.2 Functions in 6-channel DMX mode

Channel	Value	Function
1	0 ... 255	Dimmer (0 % to 100 %)
2	0 ... 255	Intensity red (0 % to 100 %)
3	0 ... 255	Intensity green (0 % to 100 %)

Channel	Value	Function
4	0 ... 255	Intensity blue (0 % to 100 %)
5	0 ... 255	Intensity white (0 % to 100 %)
6	0 ... 255	Stroboscope effect (0 % to 100 %)

7.3.3 Functions in 8-channel DMX mode

Channel	Value	Function
1	0 ... 255	Dimmer (0 % to 100 %)
2	0 ... 255	Intensity Red (0 % to 100 %), if channel 6 = 0
3	0 ... 255	Intensity Green (0 % to 100 %), if channel 6 = 0
4	0 ... 255	Intensity Blue (0 % to 100 %), if channel 6 = 0
5	0 ... 255	Intensity white (0 % bis 100 %), if channel 6 = 0

Channel	Value	Function
6	Programme selection	
	0	No function
	1 ... 16	Programme 01
	17 ... 33	Programme 02
	34 ... 50	Programme 03
	51 ... 67	Programme 04
	68 ... 84	Programme 05
	85 ... 101	Programme 06
	102 ... 118	Programme 07
	119 ... 135	Programme 08
	136 ... 152	Programme 09
	153 ... 169	Programme 10
170 ... 186	Programme 11	

Channel	Value	Function
	187 ... 203	Programme 12
	204 ... 220	Programme 13
	221 ... 237	Programme 14
	238 ... 255	Sound-controlled operation
7	Colour macros programme 01	
	0 ... 15	Red 0 % / Green 0 % / Blue 0 % / White 0 %, if channel 6 = 1 ... 16
	16 ... 31	Red 255 % / Green 0 % / Blue 0 % / White 0 %, if channel 6 = 1 ... 16
	32 ... 47	Red 0 % / Green 255 % / Blue 0 % / White 0 %, if channel 6 = 1 ... 16
	48 ... 63	Red 0 % / Green 0 % / Blue 255 % / White 0 %, if channel 6 = 1 ... 16
	64 ... 79	Red 0 % / Green 0 % / Blue 0 % / White 255 %, if channel 6 = 1 ... 16
	80 ... 95	Red 255 % / Green 150 % / Blue 0 % / White 0 %, if channel 6 = 1 ... 16
	96 ... 111	Red 255 % / Green 180 % / Blue 0 % / White 0 %, if channel 6 = 1 ... 16
	112 ... 127	Red 255 % / Green 255 % / Blue 0 % / White 0 %, if channel 6 = 1 ... 16

LED Pot 12×1W QCL RGB WW 15°, LED Pot 12×1W QCL RGB WW 40°

Channel	Value	Function
	128 ... 143	Red 255 % / Green 0 % / Blue 255 % / White 0 %, if channel 6 = 1 ... 16
	144 ... 159	Red 255 % / Green 0 % / Blue 140 % / White 0 %, if channel 6 = 1 ... 16
	160 ... 175	Red 0 % / Green 255 % / Blue 255 % / White 0 %, if channel 6 = 1 ... 16
	176 ... 191	Red 255 % / Green 0 % / Blue 0 % / White 210 %, if channel 6 = 1 ... 16
	192 ... 207	Red 0 % / Green 255 % / Blue 0 % / White 210 %, if channel 6 = 1 ... 16
	208 ... 223	Red 0 % / Green 0 % / Blue 255 % / White 210 %, if channel 6 = 1 ... 16
	224 ... 239	Red 255 % / Green 200 % / Blue 40 % / White 90 %, if channel 6 = 1 ... 16
	240 ... 255	Red 255 % / Green 255 % / Blue 255 % / White 255 %, if channel 6 = 1 ... 16
	0 ... 255	Microphone sensitivity, if channel 6 = 238 ... 255
8	0	No function
	1 ... 255	Stroboscope effect (0 % to 100 %)

7.4 Operating mode Slave

This setting takes effect only when the device is not operated under DMX control.

Press *[Mode]* or *[Up]* | *[Down]* repeatedly until the display shows 'SLAv'. The device now operates in slave mode and follows the sequences of the controlling master device.

7.5 Operating mode Dimmer

Dimmer operation can only be activated when the unit is operating in stand alone mode or as master in a master / slave combination. This setting takes effect only when the device is not operated under DMX control.

Press *[Mode]* or *[Up]* | *[Down]* repeatedly until the display shows 'Colr'. All LEDs light up with full intensity. Press *[Setup]* and adjust the intensity of each basic colour in turn as desired:

- Red: 'r.000' ... 'r.255'
- Green: 'g.000' ... 'g.255'
- Blue: 'b.000' ... 'b.255'
- White: 'u.000' ... 'u.255'

7.6 Sound control

Sound control can only be activated when the unit is operating in stand alone mode or as master in a master / slave combination. This setting takes effect only when the device is not operated under DMX control. In this operating mode, the device responds to acoustic pulses which are recorded by the integrated microphone.

Press *[Mode]* or *[Up]* | *[Down]* repeatedly until the display shows 'Soud'. Press *[Setup]* and use *[Up]* | *[Down]* to adjust the microphone sensitivity in a range from 'SU.00' ... 'SU.31'.

7.7 Reset to factory defaults

Press *[Mode]* or *[Up]* | *[Down]* repeatedly until the display shows 'Set'. Press *[Setup]*, the display shows '-rSt'. Press *[Setup]* again to reset all values to their factory default settings.

7.8 Device info

Press *[Mode]* or *[Up]* | *[Down]* repeatedly until the display shows 'InFo'. Press *[Setup]*, the display shows 'tEnP'. Press *[Setup]* again. The display shows 't-on'. If you press *[Up]* or *[Down]* while the display shows 'tEnP', the display shows 'VEr'. Press *SETUP* to let the device show the firmware version.

7.9 Menu overview

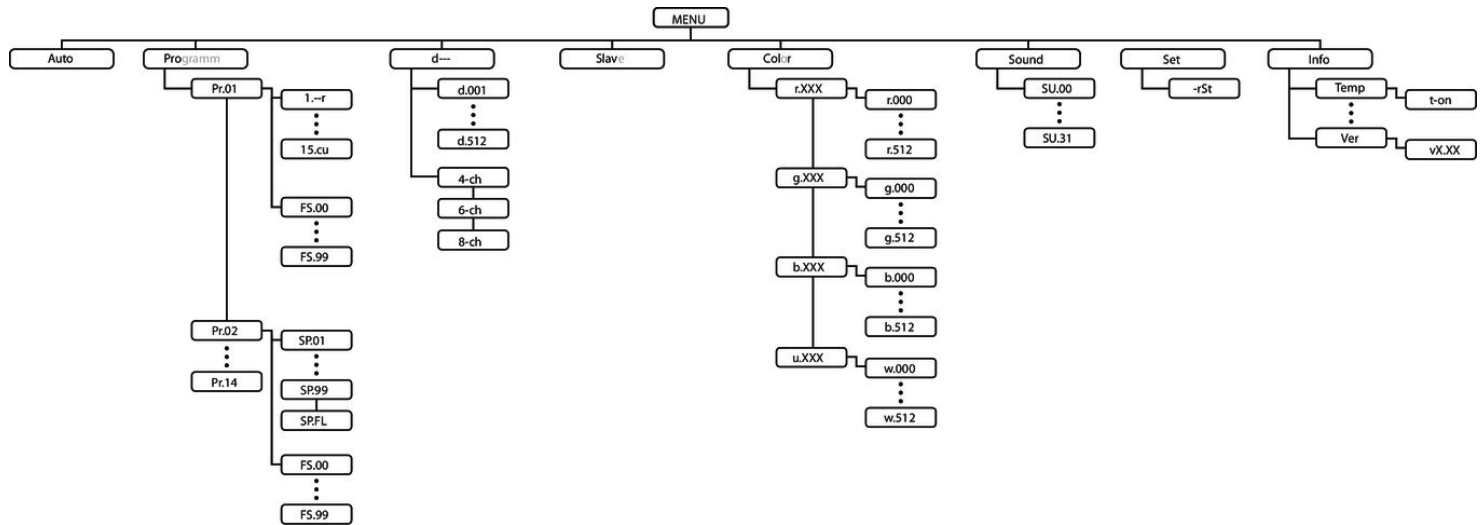

8 Technical specifications

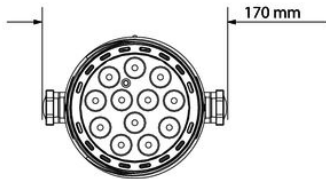
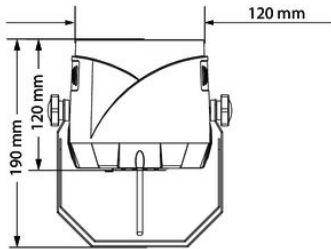

		LED Pot 12×1W QCL RGB WW 15° Item no. 409499	LED Pot 12×1W QCL RGB WW 40° Item no. 428047
Light source	12 × TrueColour LED, 1 W (each 3 × red, green, blue and white)		
Optical properties	Beam angle	15°	40°
Control	DMX Remote control (optional)		
Number of DMX channels	4, 6 or 8		
Input connections	DMX control	XLR chassis socket, 3-pin	
Output connections	DMX control	XLR chassis socket, 3-pin	
Power consumption	15 W		

LED Pot 12×1W QCL RGB WW 15°, LED Pot 12×1W QCL RGB WW 40°

	LED Pot 12×1W QCL RGB WW 15° Item no. 409499	LED Pot 12×1W QCL RGB WW 40° Item no. 428047
Supply voltage	100 – 240 V ~ 50/60 Hz	
Degree of protection	IP20	
Mounting options	Hanging, standing	
Dimensions (W × H × D)	With locking screw and bracket: 170 mm × 130 mm × 190 mm	
Weight	0.42 kg	
Ambient conditions	Temperature range	0 °C...40 °C
	Relative humidity	50 %, non condensing

Further information

	LED Pot 12×1W QCL RGB WW 15° Item no. 409499	LED Pot 12×1W QCL RGB WW 40° Item no. 428047
Design	Cannon	Cannon
Colour mixture	RGB WW	RGB WW
LED type	x-in-1	x-in-1
Base housing	Yes	Yes
Fanless	Yes	Yes
Remote control	Optional	Optional
Wireless DMX	No	No
Housing colour	Black	Black

9 Plug and connection assignments

Introduction

This chapter will help you select the right cables and plugs to connect your valuable equipment so that a perfect light experience is guaranteed.

Please take our tips, because especially in 'Sound & Light' caution is indicated: Even if a plug fits into a socket, the result of an incorrect connection may be a destroyed DMX controller, a short circuit or 'just' a not working light show!

DMX connections

The unit offers a 3-pin XLR socket for DMX output and a 3-pin XLR plug for DMX input. Please refer to the drawing and table below for the pin assignment of a suitable XLR plug.



Pin	Configuration
1	Ground, shielding
2	Signal inverted (DMX-, 'cold signal')
3	Signal (DMX+, 'hot signal')

10 Troubleshooting



NOTICE!

Possible data transmission errors

For error-free operation make use of dedicated DMX cables and do not use ordinary microphone cables.

Never connect the DMX input or output to audio devices such as mixers or amplifiers.

In the following we list a few common problems that may occur during operation. We give you some suggestions for easy troubleshooting:

Symptom	Remedy
The unit does not work, no light.	Check the mains connection and the fuse.
No response to the DMX controller.	1. Check the DMX ports and cables for proper connection.
	2. Check the address settings and the DMX polarity.
	3. Try using another DMX controller.
	4. Check to see if the DMX cables run near or alongside to high voltage cables that may cause damage or interference to DMX interface circuits.

If the procedures recommended above do not succeed, please contact our Service Center. You can find the contact information at www.thomann.de.

11 Cleaning

Optical lenses

Clean the optical lenses, that are accessible from the outside, regularly in order to optimize the light output. The frequency of cleaning depends on the operating environment: wet, smoky or particularly dirty surroundings can cause more accumulation of dirt on the optics of the device.

- Clean with a soft cloth using our lamp and lens cleaner (item no. 280122).
- Always dry the parts carefully.

Fan grids

The fan grids of the device must be cleaned of any contamination, such as dust, etc. on a regular basis. Before cleaning, switch off the device and disconnect mains-operated devices from the mains. Only use pH-neutral, solvent-free and non-abrasive cleaning agents. Clean the unit with a slightly damp lint-free cloth.

12 Protecting the environment

Disposal of the packaging material



For the transport and protective packaging, environmentally friendly materials have been chosen that can be supplied to normal recycling.

Ensure that plastic bags, packaging, etc. are properly disposed of.

Do not just dispose these materials with your normal household waste, but make sure that they are fed to a recovery. Please follow the notes and markings on the packaging.

Disposal of batteries



Batteries must not be disposed of as domestic waste or thrown into fire. Dispose of the batteries according to national or local regulations regarding hazardous waste. To protect the environment, dispose of empty batteries at your retail store or at appropriate collection sites.

Disposal of your old device



This product is subject to the European Waste Electrical and Electronic Equipment Directive (WEEE) in its currently valid version. Do not dispose with your normal household waste.

Dispose this device through an approved waste disposal firm or through your local waste facility. When discarding the device, comply with the rules and regulations that apply in your country. If in doubt, consult your local waste disposal facility.



Musikhaus Thomann · Hans-Thomann-Straße 1 · 96138 Burgebrach · Germany · www.thomann.de