



STAIRVILLE

Octagon Theater
CW/WW/A 20x6W
LED PAR

Musikhaus Thomann
Thomann GmbH
Hans-Thomann-Straße 1
96138 Burgebrach
Germany
Telephone: +49 (0) 9546 9223-0
E-mail: info@thomann.de
Internet: www.thomann.de

27.04.2018, ID: 367135 (V3)

Table of contents

1	General information	5
	1.1 Further information.....	6
	1.2 Notational conventions.....	7
	1.3 Symbols and signal words.....	7
2	Safety instructions	10
3	Features	15
4	Installation	16
5	Starting up	20
6	Connections and controls	23
7	Operating	25
	7.1 Starting the device.....	25
	7.2 Main menu.....	25
	7.3 Menu overview.....	32
	7.4 Functions in 4-channel DMX mode.....	33
	7.5 Functions in 6-channel DMX mode.....	33

	7.6 Functions in 9-channel DMX mode.....	36
8	Technical specifications.....	40
9	Plug and connection assignments.....	42
10	Troubleshooting.....	43
11	Cleaning.....	45
12	Protecting the environment.....	46

1 General information

This manual contains important instructions for the safe operation of the unit. Read and follow the safety instructions and all other instructions. Keep the manual for future reference. Make sure that it is available to all those using the device. If you sell the unit please make sure that the buyer also receives this manual.

Our products are subject to a process of continuous development. Thus, they are subject to change.

1.1 Further information

On our website (www.thomann.de) you will find lots of further information and details on the following points:

Download	This manual is also available as PDF file for you to download.
Keyword search	Use the search function in the electronic version to find the topics of interest for you quickly.
Online guides	Our online guides provide detailed information on technical basics and terms.
Personal consultation	For personal consultation please contact our technical hotline.
Service	If you have any problems with the device the customer service will gladly assist you.

1.2 Notational conventions

This manual uses the following notational conventions:

Letterings

The letterings for connectors and controls are marked by square brackets and italics.

Examples: *[VOLUME]* control, *[Mono]* button.



Cross-references

References to other locations in this manual are identified by an arrow and the specified page number. In the electronic version of the manual, you can click the cross-reference to jump to the specified location.

Example: See ↗ *'Cross-references'* on page 7.

1.3 Symbols and signal words

In this section you will find an overview of the meaning of symbols and signal words that are used in this manual.

Signal word	Meaning
DANGER!	This combination of symbol and signal word indicates an immediate dangerous situation that will result in death or serious injury if it is not avoided.
WARNING!	This combination of symbol and signal word indicates a possible dangerous situation that can result in death or serious injury if it is not avoided.
NOTICE!	This combination of symbol and signal word indicates a possible dangerous situation that can result in material and environmental damage if it is not avoided.
Warning signs	Type of danger
	Warning – high-voltage.
	Warning – suspended load.

Warning signs	Type of danger
	Warning – danger zone.

2 Safety instructions

Intended use

This device is intended for use as an electronic lighting effect by means of LED technology. The device is designed for professional use and is not suitable for use in households. Use the device only as described in this user manual. Any other use or use under other operating conditions is considered to be improper and may result in personal injury or property damage. No liability will be assumed for damages resulting from improper use.

This device may be used only by persons with sufficient physical, sensorial, and intellectual abilities and having corresponding knowledge and experience. Other persons may use this device only if they are supervised or instructed by a person who is responsible for their safety.

Extend the life of the device by regular breaks in operation and avoid switching it on and off frequently. This device is not suitable for continuous use.

Safety**DANGER!****Danger for children**

Ensure that plastic bags, packaging, etc. are disposed of properly and are not within reach of babies and young children. Choking hazard!

Ensure that children do not detach any small parts (e.g. knobs or the like) from the unit. They could swallow the pieces and choke!

Never let children unattended use electrical devices.

**DANGER!****Electric shock caused by high voltages inside**

Within the device there are areas where high voltages may be present. Never remove any covers.

There are no user-serviceable parts inside.

Do not use the device if covers, protectors or optical components are missing or damaged.



DANGER!

Electric shock caused by short-circuit

Always use proper ready-made insulated mains cabling (power cord) with a protective contact plug. Do not modify the mains cable or the plug. Failure to do so could result in electric shock/death or fire. If in doubt, seek advice from a registered electrician.



WARNING!

Eye damage caused by high light intensity

Never look directly into the light source.



WARNING!

Risk of epileptic shock

Strobe lighting can trigger seizures in photosensitive epilepsy. Sensitive persons should avoid looking at strobe lights.



WARNING!

Risk of injury caused by falling objects

Make sure that the installation complies with the standards and rules that apply in your country. Always secure the device with a secondary safety attachment, such as a safety cable or a safety chain.

Secure the barn door with a safety cable on the spotlight after installation. The safety cable must run outside the barn door and must not interfere with the light emission.



NOTICE!

Risk of fire

Do not block areas of ventilation. Do not install the device near any direct heat source. Keep the device away from naked flames.



NOTICE!

Operating conditions

This device has been designed for indoor use only. To prevent damage, never expose the device to any liquid or moisture. Avoid direct sunlight, heavy dirt, and strong vibrations.



NOTICE!

Power supply

Before connecting the device, ensure that the input voltage (AC outlet) matches the voltage rating of the device and that the AC outlet is protected by a residual current circuit breaker. Failure to do so could result in damage to the device and possibly injure the user.

Unplug the device before electrical storms occur and when it is unused for long periods of time to reduce the risk of electric shock or fire.

3 Features

The Octagon Theater CW/WW/A 20×6W is a professional LED spot and an energy-saving alternative to traditional halogen spotlights. It is suitable for both the daily tour routine as well as for use on stages and in festival halls.

Special features of the device:

- 20 × high-power LED, TCL tricolor with each 6 W (cold white, warm white, amber-coloured)
- steplessly adjustable colour temperature of 2800 ... 6400 K
- Control via DMX and via buttons and display on the unit
- Master / Slave operation
- Sound control

For technological reasons, the light output of LEDs decreases over their lifetime. This effect increases with higher operating temperature. You can extend the service life of the illuminants by providing adequate ventilation and operating the LEDs with the lowest possible brightness.

4 Installation

Unpack and carefully check that there is no transportation damage before using the unit. Keep the equipment packaging. To fully protect the device against vibration, dust and moisture during transportation or storage use the original packaging or your own packaging material suitable for transport or storage, respectively.



WARNING!

Risk of injury caused by falling objects

Make sure that the installation complies with the standards and rules that apply in your country. Always secure the device with a secondary safety attachment, such as a safety cable or a safety chain.

Secure the barn door with a safety cable on the spotlight after installation. The safety cable must run outside the barn door and must not interfere with the light emission.



NOTICE!

Risk of overheating

The distance between light output and the illuminated surface must be more than 1.5 m (19.7in).

Provide sufficient ventilation.

The ambient temperature must always be below 40 °C (104 °F).



NOTICE!

Use of stands

When mounting the device onto a stand, ensure that the stand is in a safe and stable position and that the weight of the device does not exceed the maximum permissible load capacity of the stand.



NOTICE!

Possible data transmission errors

For error-free operation make use of dedicated DMX cables and do not use ordinary microphone cables.

Never connect the DMX input or output to audio devices such as mixers or amplifiers.

Mounting options

You can install the unit in hanging or standing position. When in use, the device must always be attached to a solid surface or an approved truss. Use the openings of the two-piece bracket for mounting.

Always work from a stable platform whenever installing, moving or servicing the unit. In doing so, the area underneath the unit must be cordoned off.

The safety cable must be attached to the bracket.



Please note that this device must not be connected to a dimmer.

5 Starting up

Create all connections while the device is off. Use the shortest possible high-quality cables for all connections. Take care when running the cables to prevent tripping hazards.

Connections in DMX mode

Connect the DMX input of the device to the DMX output of a DMX controller or another DMX device. Connect the output of the first DMX device to the input of the second one, and so on to form a daisy chain. Always ensure that the output of the last DMX device in the daisy chain is terminated with a resistor ($110\ \Omega$, $\frac{1}{4}\ \text{W}$).

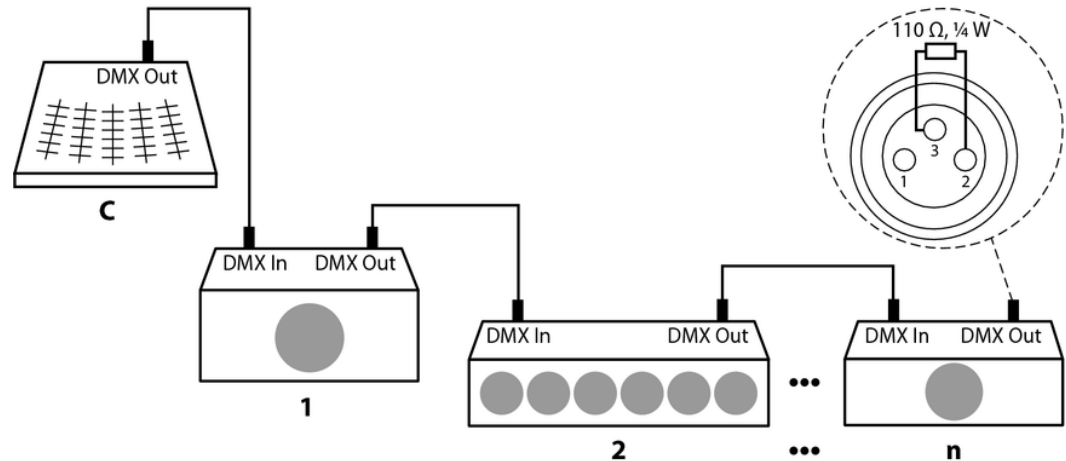

Connections in master/slave mode

When you configure a group of devices in master/slave mode, the first unit will control the other units for an automatic, sound-activated, synchronized show. This function is ideal when you want to start a show immediately. Connect the DMX output of the master device to the DMX input of the first slave device. Then connect the DMX output of the first slave device to the DMX input of the second slave device and so on.

6 Connections and controls

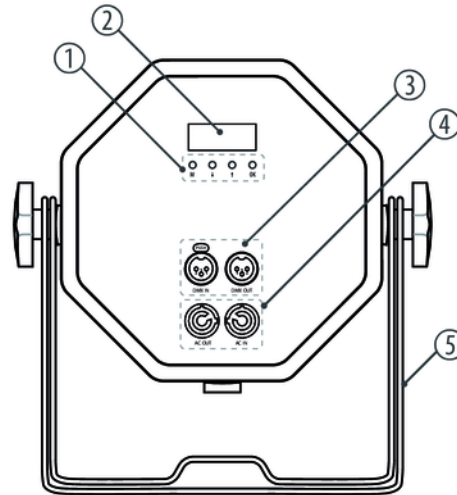

Octagon Theater CW/WW/A 20x6W

1	Operating buttons: <i>[OK]</i> : confirms a selected value. <i>[M]</i> : calls the main menu or a submenu. ↑, ↓: arrow buttons to increase or decrease the currently displayed value.
2	Display
3	<i>[DMX IN]</i> : DMX input <i>[DMX OUT]</i> : DMX output.
4	<i>[AC IN]</i> : Lockable input socket (Power Twist) <i>[AC OUT]</i> : Lockable output socket (Power Twist) to supply a connected unit.
5	Double bracket for floor placement or hanging.

7 Operating

7.1 Starting the device

Connect the device to the power supply to start operation. The device is immediately operational and operates in the last mode with the settings last selected.

7.2 Main menu

Menu control

Press *[M]* to open the main menu. Use the arrow buttons to select the desired parameter or to change the respectively displayed value. When the display shows the desired parameter or value, press *[OK]* to enter the respective submenu or to confirm a new value. Press *[M]* to return to the previous menu level without changes (for menu structure see).

DMX address

Press *[M]*. Press one of the arrow buttons repeatedly until the display shows 'DMX'. Use the arrow keys to select the submenu 'ADDR.' and confirm with *[OK]*. Now you can set the number of the first DMX channel to be used by the device (DMX address). Use the arrow keys to select a value between 1 and 512.

Confirm the selection with *[OK]*. Use *[M]* to return to the parent menu.

To return to the parent menu without changes, press *[M]* without prior confirmation.

Make sure that this number matches the configuration of your DMX controller. The following table shows the highest possible DMX address for the various DMX modes

Mode	Highest possible DMX address
4-channel	509
6-channel	507
9-channel	504

DMX mode

Press *[M]*. Press one of the arrow buttons repeatedly until the display shows 'DMX'. Use the arrow keys to select the submenu 'MODE' and confirm with *[OK]*. Now you can select the desired DMX mode:

- '4CH' (four channels,)
- '6CH' (six channels,)
- '9CH' (nine channels,)

Confirm the selection with *[OK]*. Use *[M]* to return to the parent menu.

To return to the parent menu without changes, press *[M]* without prior confirmation.

Dimmer setting

Press *[M]*. Press one of the arrow buttons repeatedly until the display shows 'DIMM'. Press *[OK]*. Use the arrow buttons to select the desired submenu:

- 'WHT': Brightness cold white
- 'WARM': Brightness warm white
- 'ORG': Brightness amber
- 'MAST': Master

Use the arrow buttons to select the desired setting and confirm with *[OK]*.

This setting is only relevant if the device is not controlled via DMX. When the display shows the desired value press *[OK]* to confirm the selection and then *[M]* to return to the parent menu. To return to the parent menu without changes press *[M]* without prior confirmation.

Strobe effect

Press *[M]*. Press one of the arrow buttons repeatedly until the display shows 'STRO'. Press *[OK]*. Use the arrow buttons to select the desired submenu:

- 'MODE': Programme selection
- 'SPE': Strobe speed
- 'MIC': Sound control
- 'MAST': Master

Use the arrow buttons to select the desired setting and confirm with *[OK]*.

This setting is only relevant if the device is not controlled via DMX. When the display shows the desired value press *[OK]* to confirm the selection and then *[M]* to return to the parent menu. To return to the parent menu without changes press *[M]* without prior confirmation.

Programme mode

Press *[M]*. Press one of the arrow buttons repeatedly until the display shows 'STEP'. Press *[OK]*. Use the arrow buttons to select the desired submenu:

- 'MODE': Programme selection
- 'SPEE': Programme speed
- 'MIC': Sound control
- 'MAST': Master

Use the arrow buttons to select the desired setting and confirm with *[OK]*.

This setting is only relevant if the device is not controlled via DMX. When the display shows the desired value press *[OK]* to confirm the selection and then *[M]* to return to the parent menu. To return to the parent menu without changes press *[M]* without prior confirmation.

Fade setting

Press *[M]*. Press one of the arrow buttons repeatedly until the display shows 'FADE'. Press *[OK]*. Use the arrow buttons to select the desired submenu:

- 'MODE': Fade mode
- 'SPEE': Fade speed
- 'MAST': Master

Use the arrow buttons to select the desired setting and confirm with *[OK]*.

This setting is only relevant if the device is not controlled via DMX. When the display shows the desired value press *[OK]* to confirm the selection and then *[M]* to return to the parent menu. To return to the parent menu without changes press *[M]* without prior confirmation.

7.3 Menu overview

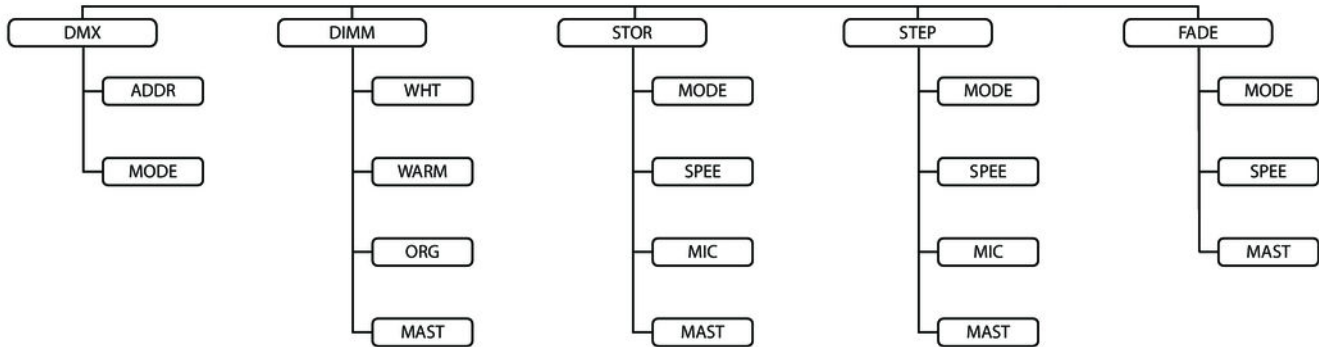

7.4 Functions in 4-channel DMX mode

Channel	Value	Function
1	0 ... 255	Intensity cold white (0 % to 100 %)
2	0 ... 255	Intensity warm white (0 % to 100 %)
3	0 ... 255	Intensity Amber (0 % to 100 %)
4	0 ... 255	Dimmer

7.5 Functions in 6-channel DMX mode

Channel	Value	Function
1	0 ... 255	Intensity cold white, if channel 6 = 11 to 50
		Sound control mode 2, if channel 6 = 91 to 130
		Programme selection, if channel 6 = 171 to 210

Channel	Value	Function
		Intensity strobe effect, if channel 6 = 211 to 255
2	0 ... 255	Intensity warm white, if channel 6 = 11 to 50
		Sound control mode 2, if channel 6 = 91 to 130
		Programme selection, if channel 6 = 171 to 210
		Intensity strobe effect, if channel 6 = 211 to 255
3	0 ... 255	Intensity Amber, if channel 6 = 11 to 50
		Sound control mode 2, if channel 6 = 91 to 130
		Programme selection, if channel 6 = 171 to 210
		Intensity strobe effect, if channel 6 = 211 to 255
4	0 ... 255	Fade speed, if channel 6 = 131 to 170
		Programme speed, if channel 6 = 171 to 210
		Strobe effect speed, if channel 6 = 211 to 255
5	0 ... 255	Sound control mode 1, if channel 6 = 51 to 90

Channel	Value	Function
		Fade colour hue, if channel 6 = 131 to 170
		Programme colour hue, if channel 6 = 171 to 210
6	0 ... 10	All functions off
	11 ... 50	Dimmer
	51 ... 90	Sound control, mode 1
	91 ... 130	Sound control, mode 2
	131 ... 170	Fading
	171 ... 210	Programme selection
	211 ... 255	Strobe effect

7.6 Functions in 9-channel DMX mode

Channel	Value	Function
1	0 ... 255	Intensity cold white, if channel 3 = 31 to 70 or 231 to 255
		Sound control, if channel 3 = 71 to 110
2	0 ... 255	Fade out speed cold white, if channel 3 = 111 to 150
		Fade in speed cold white, if channel 3 = 151 to 190
		Fade in / out speed cold white, if channel 3 = 191 to 230
		Intensity strobe effect cold white, if channel 3 = 231 to 255
3	0 ... 30	Without function
	31 ... 70	Intensity cold white
	71 ... 110	Sound control
	111 ... 150	Fade out cold white
	151 ... 190	Fade in cold white

Channel	Value	Function
	191 ... 230	Fade in / out cold white
	231 ... 255	Strobe effect cold white
4	0 ... 255	Intensity warm white, if channel 6 = 31 to 70 or 231 to 255
		Sound control, if channel 6 = 71 to 110
5	0 ... 255	Fade out speed warm white, if channel 6 = 111 to 150
		Fade in speed warm white, if channel 6 = 151 to 190
		Fade in / out speed warm white, if channel 6 = 191 to 230
		Intensity strobe effect warm white, if channel 6 = 231 to 255
6	0 ... 30	Without function
	31 ... 70	Intensity warm white
	71 ... 110	Sound control
	111 ... 150	Fade out warm white
	151 ... 190	Fade in warm white

Channel	Value	Function
	191 ... 230	Fade in / out warm white
	231 ... 255	Strobe effect warm white
7	0 ... 255	Intensity Amber, if channel 9 = 31 to 70 or 231 to 255
		Sound control, if channel 9 = 71 to 110
8	0 ... 255	Fade out speed Amber, if channel 9 = 111 to 150
		Fade in speed Amber, if channel 9 = 151 to 190
		Fade in / out speed Amber, if channel 9 = 191 to 230
		Intensity strobe effect Amber, if channel 9 = 231 to 255
9	0 ... 30	Without function
	31 ... 70	Intensity Amber
	71 ... 110	Sound control
	111 ... 150	Fade out Amber
	151 ... 190	Fade in Amber

Channel	Value	Function
	191 ... 230	Fade in / out Amber
	231 ... 255	Strobe effect Amber

8 Technical specifications

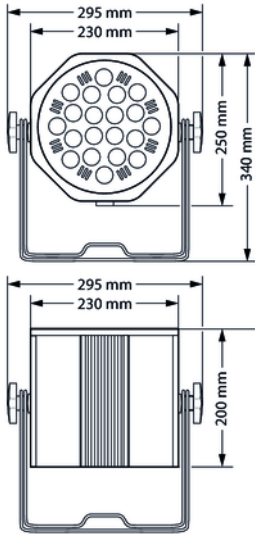

Illuminant	20 × high-power LED, TCL tricolour, each 6 W
Colour temperature	2800 ... 6400 K
Number of DMX channels	4, 6 or 9
Beam angle	approx. 36 °
Operating supply voltage	100 – 240 V ~ 50/60 Hz
Protection	IP30
Power consumption	120 W
Dimensions (W × H × D)	Housing: 230 mm × 250 mm × 200 mm, incl. screws and bracket: 295 mm × 340 mm × 200 mm
Weight	4 kg

Environmental conditions

Temperature range	0 °C...40 °C
Relative humidity	50 %, non-condensing

9 Plug and connection assignments

Introduction

This chapter will help you select the right cables and plugs to connect your valuable equipment so that a perfect light experience is guaranteed.

Please take our tips, because especially in 'Sound & Light' caution is indicated: Even if a plug fits into a socket, the result of an incorrect connection may be a destroyed DMX controller, a short circuit or 'just' a not working light show!

DMX connections

The unit offers a 3-pin XLR socket for DMX output and a 3-pin XLR plug for DMX input. Please refer to the drawing and table below for the pin assignment of a suitable XLR plug.



Pin	Configuration
1	Ground, shielding
2	Signal inverted (DMX-, 'cold signal')
3	Signal (DMX+, 'hot signal')

10 Troubleshooting



NOTICE!

Possible data transmission errors

For error-free operation make use of dedicated DMX cables and do not use ordinary microphone cables.

Never connect the DMX input or output to audio devices such as mixers or amplifiers.

In the following we list a few common problems that may occur during operation. We give you some suggestions for easy troubleshooting:

Symptom	Remedy
The unit does not work, no light.	Check the mains connection and the fuse.
No response to the DMX controller.	1. Check the DMX ports and cables for proper connection.
	2. Check the address settings and the DMX polarity.
	3. Try using another DMX controller.
	4. Check to see if the DMX cables run near or alongside to high voltage cables that may cause damage or interference to DMX interface circuits.

If the procedures recommended above do not succeed, please contact our Service Center. You can find the contact information at www.thomann.de.

11 Cleaning

Optical lenses

Clean the optical lenses, that are accessible from the outside, regularly in order to optimize the light output. The frequency of cleaning depends on the operating environment: wet, smoky or particularly dirty surroundings can cause more accumulation of dirt on the optics of the device.

- Clean with a soft cloth using our lamp and lens cleaner (item no. 280122).
- Always dry the parts carefully.

Fan grids

The fan grids of the device must be cleaned on a regular basis to remove dust and dirt. Before cleaning, switch off the device and disconnect AC-powered devices from the mains. Use a lint-free damp cloth for cleaning. Never use solvents or alcohol for cleaning.

12 Protecting the environment

Disposal of the packaging material



For the transport and protective packaging, environmentally friendly materials have been chosen that can be supplied to normal recycling.

Ensure that plastic bags, packaging, etc. are properly disposed of.

Do not just dispose of these materials with your normal household waste, but make sure that they are collected for recycling. Please follow the notes and markings on the packaging.

Disposal of your old device



This product is subject to the European Waste Electrical and Electronic Equipment Directive (WEEE) in its currently valid version. Do not dispose with your normal household waste.

Dispose of this device through an approved waste disposal firm or through your local waste facility. When discarding the device, comply with the rules and regulations that apply in your country. If in doubt, consult your local waste disposal facility.



