



Hero Wash  
712 Z RGBW Zoom

moving head

Musikhaus Thomann  
Thomann GmbH  
Hans-Thomann-Straße 1  
96138 Burgebrach  
Germany  
Telephone: +49 (0) 9546 9223-0  
E-mail: [info@thomann.de](mailto:info@thomann.de)  
Internet: [www.thomann.de](http://www.thomann.de)

06.05.2019, ID: 449222 (V2)

# Table of contents

<b>1</b>	<b>General information</b> .....	<b>6</b>
	1.1 Further information.....	7
	1.2 Notational conventions.....	8
	1.3 Symbols and signal words.....	9
<b>2</b>	<b>Safety instructions</b> .....	<b>11</b>
<b>3</b>	<b>Features</b> .....	<b>19</b>
<b>4</b>	<b>Installation</b> .....	<b>20</b>
<b>5</b>	<b>Starting up</b> .....	<b>24</b>
<b>6</b>	<b>Connections and controls</b> .....	<b>27</b>
<b>7</b>	<b>Operating</b> .....	<b>30</b>
	7.1 Starting the device.....	30
	7.2 Main menu.....	31
	7.3 Functions in 8-channel DMX mode.....	40
	7.4 Functions in 15-channel DMX mode.....	43
<b>8</b>	<b>Technical specifications</b> .....	<b>48</b>

<b>9</b>	<b>Troubleshooting.....</b>	<b>50</b>
<b>10</b>	<b>Cleaning.....</b>	<b>52</b>
<b>11</b>	<b>Protecting the environment.....</b>	<b>53</b>



Hero Wash 712 Z RGBW Zoom  
moving head

# 1 General information

This user manual contains important information on the safe operation of the device. Read and follow all safety notes and all instructions. Save this manual for future reference. Make sure that it is available to all persons using this device. If you sell the device to another user, be sure that they also receive this manual.

Our products and user manuals are subject to a process of continuous development. We therefore reserve the right to make changes without notice. Please refer to the latest version of the user manual which is ready for download under [www.thomann.de](http://www.thomann.de).

## 1.1 Further information

On our website ([www.thomann.de](http://www.thomann.de)) you will find lots of further information and details on the following points:

Download	This manual is also available as PDF file for you to download.
Keyword search	Use the search function in the electronic version to find the topics of interest for you quickly.
Online guides	Our online guides provide detailed information on technical basics and terms.
Personal consultation	For personal consultation please contact our technical hotline.
Service	If you have any problems with the device the customer service will gladly assist you.

## 1.2 Notational conventions

This manual uses the following notational conventions:

### Letterings

The letterings for connectors and controls are marked by square brackets and italics.

**Examples:** *[VOLUME]* control, *[Mono]* button.

### Displays

Texts and values displayed on the device are marked by quotation marks and italics.

**Examples:** *'24ch'*, *'OFF'*.

### Cross-references

References to other locations in this manual are identified by an arrow and the specified page number. In the electronic version of the manual, you can click the cross-reference to jump to the specified location.





Example: See  *'Cross-references'* on page 8.



## 1.3 Symbols and signal words

In this section you will find an overview of the meaning of symbols and signal words that are used in this manual.

Signal word	Meaning
<b>DANGER!</b>	This combination of symbol and signal word indicates an immediate dangerous situation that will result in death or serious injury if it is not avoided.
<b>WARNING!</b>	This combination of symbol and signal word indicates a possible dangerous situation that can result in death or serious injury if it is not avoided.
<b>CAUTION!</b>	This combination of symbol and signal word indicates a possible dangerous situation that can result in minor injury if it is not avoided.
<b>NOTICE!</b>	This combination of symbol and signal word indicates a possible dangerous situation that can result in material and environmental damage if it is not avoided.

Warning signs	Type of danger
	Warning – high-voltage.
	Warning – dangerous optical radiation.
	Warning – suspended load.
	Warning – danger zone.

## 2 Safety instructions

### Intended use

This device is intended for use as a freely moving multifunctional spotlight. The device is designed for professional use and is not suitable for use in households. Use the device only as described in this user manual. Any other use or use under other operating conditions is considered to be improper and may result in personal injury or property damage. No liability will be assumed for damages resulting from improper use.

This device may be used only by persons with sufficient physical, sensorial, and intellectual abilities and having corresponding knowledge and experience. Other persons may use this device only if they are supervised or instructed by a person who is responsible for their safety.

Extend the operating life of the device by regular breaks and by avoiding frequent switching on and off. The device is not suitable for continuous operation.

### Safety



#### **DANGER!**

##### **Danger for children**

Ensure that plastic bags, packaging, etc. are disposed of properly and are not within reach of babies and young children. Choking hazard!

Ensure that children do not detach any small parts (e.g. knobs or the like) from the unit. They could swallow the pieces and choke!

Never let children unattended use electrical devices.



#### **DANGER!**

##### **Electric shock caused by high voltages inside**

Within the device there are areas where high voltages may be present. Never remove any covers.

There are no user-serviceable parts inside.

Do not use the device if covers, protectors or optical components are missing or damaged.



**DANGER!**

**Electric shock caused by short-circuit**

Always use proper ready-made insulated mains cabling (power cord) with a protective contact plug. Do not modify the mains cable or the plug. Failure to do so could result in electric shock/death or fire. If in doubt, seek advice from a registered electrician.



**WARNING!**

**Eye damage caused by high light intensity**

Never look directly into the light source.



**WARNING!**

**Risk of epileptic shock**

Strobe lighting can trigger seizures in photosensitive epilepsy. Sensitive persons should avoid looking at strobe lights.



### **WARNING!**

#### **Risk of injury caused by falling objects**

Make sure that the installation complies with the standards and rules that apply in your country. Always secure the device with a secondary safety attachment, such as a safety cable or a safety chain.

The load capacity of trusses or other fixtures must be sufficient for the intended number of devices. Note that the movement of the head places additional loads on the load-bearing parts.



**CAUTION!**

**Risk of injury due to movements of the device**

The head of the device can move quickly (pan, tilt) and can produce very bright light. This is also valid immediately after you turn on the device, when the device operates in automatic mode or under remote control and when you turn off a DMX controller that is connected to the device. Persons staying near the device could be injured or frightened.

Before you turn on the device and during the operation, always ensure that nobody stays close to the device. If work has to be performed in the area of movement or in the near vicinity of the device, it must remain turned off.



**NOTICE!**

**Risk of fire**

Do not block areas of ventilation. Do not install the device near any direct heat source. Keep the device away from naked flames.



### **NOTICE!**

#### **Operating conditions**

This device has been designed for indoor use only. To prevent damage, never expose the device to any liquid or moisture. Avoid direct sunlight, heavy dirt, and strong vibrations.

Only operate the device within the ambient conditions specified in the chapter 'Technical specifications' of this user manual. Avoid heavy temperature fluctuations and do not switch the device on immediately after it was exposed to temperature fluctuations (for example after transport at low outside temperatures).

Dust and dirt inside can damage the unit. When operated in harmful ambient conditions (dust, smoke, nicotine, fog, etc.), the unit should be maintained by qualified service personnel at regular intervals to prevent overheating and other malfunction.

The device must not be moved during use.





**NOTICE!**

**Power supply**

Before connecting the device, ensure that the input voltage (AC outlet) matches the voltage rating of the device and that the AC outlet is protected by a residual current circuit breaker. Failure to do so could result in damage to the device and possibly injure the user.

Unplug the device before electrical storms occur and when it is unused for long periods of time to reduce the risk of electric shock or fire.



**NOTICE!**

**Possible staining**

The plasticiser contained in the rubber feet of this product may possibly react with the coating of your parquet, linoleum, laminate or PVC floor and after some time cause permanent dark stains.

In case of doubt, do not put the rubber feet directly on the floor, but use felt-pad floor protectors or a carpet.



### **NOTICE!**

#### **Risk of overheating**

The distance between light output and the illuminated surface must be more than 1.5 m (19.7in).

Provide sufficient ventilation.

The ambient temperature must always be below 40 °C (104 °F).



### **NOTICE!**

#### **Possible damage due to installation of a wrong fuse**

The use of different types of fuses can cause serious damage to the unit. Fire hazard!

Only fuses of the same type may be used.

### 3 Features

The Moving Head is ideal for mobile DJs, entertainers and use in bars.

Special features of the device:

- 7 four-colour LEDs (RGBW, 12 W each)
- Control via DMX (8 or 15 channels) as well as buttons and display on the unit
- Built-in automatic show programmes
- Sound control
- Master / Slave mode
- Strobe effect
- Electronic dimmer
- Robust metal and plastic housing

For technological reasons, the light output of LEDs decreases over their lifetime. This effect increases with higher operating temperature. You can extend the service life of the illuminants by providing adequate ventilation and operating the LEDs with the lowest possible brightness.

## 4 Installation

Unpack and check carefully there is no transportation damage before using the unit. Keep the equipment packaging. To fully protect the product against vibration, dust and moisture during transportation or storage use the original packaging or your own packaging material suitable for transport or storage, respectively.

Lift the device only at the base. When lifted at the rotatable mounting, the device may be damaged.

You can install the device standing or hanging. When in use, the device must be mounted at a solid surface or clamped to an approved truss.

Work from a stable platform whenever you install or move the device or when you perform any kind of maintenance. Block access under the work area.

**WARNING!****Risk of injury caused by falling objects**

Make sure that the installation complies with the standards and rules that apply in your country. Always secure the device with a secondary safety attachment, such as a safety cable or a safety chain.

The load capacity of trusses or other fixtures must be sufficient for the intended number of devices. Note that the movement of the head places additional loads on the load-bearing parts.

**NOTICE!****Risk of overheating**

The distance between light output and the illuminated surface must be more than 1.5 m (19.7in).

Provide sufficient ventilation.

The ambient temperature must always be below 40 °C (104 °F).



### **NOTICE!**

#### **Possible data transmission errors**

For error-free operation make use of dedicated DMX cables and do not use ordinary microphone cables.

Never connect the DMX input or output to audio devices such as mixers or amplifiers.

## Mounting options

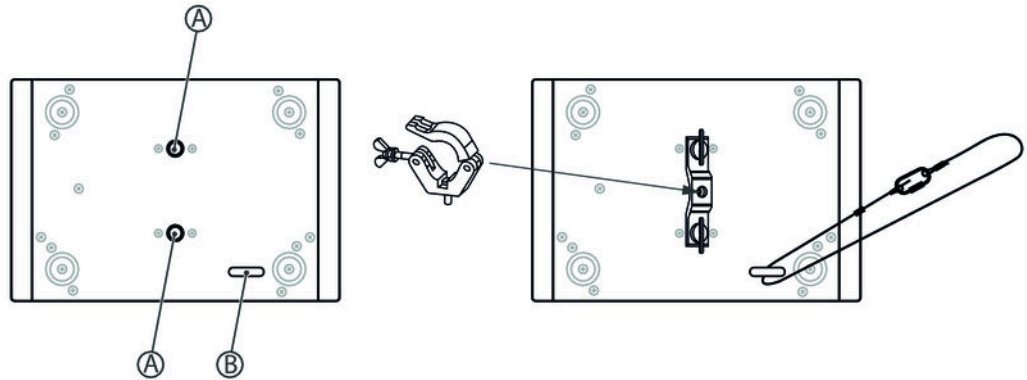

The threads on the bottom side of the housing (A) allow the secure attachment of the included mounting bracket. There, you can fasten adapters such as half couplers, trigger clamps, c-hooks etc. Safety cables are being threaded through the eyelet (B) on the bottom side of the housing.

## 5 Starting up

Create all connections while the device is off. Use the shortest possible high-quality cables for all connections. Take care when running the cables to prevent tripping hazards.



**Connections in DMX mode**

Connect the DMX input of the device to the DMX output of a DMX controller or another DMX device. Connect the output of the first DMX device to the input of the second one, and so on to form a daisy chain. Always ensure that the output of the last DMX device in the daisy chain is terminated with a resistor ( $110\ \Omega$ ,  $\frac{1}{4}\ \text{W}$ ).

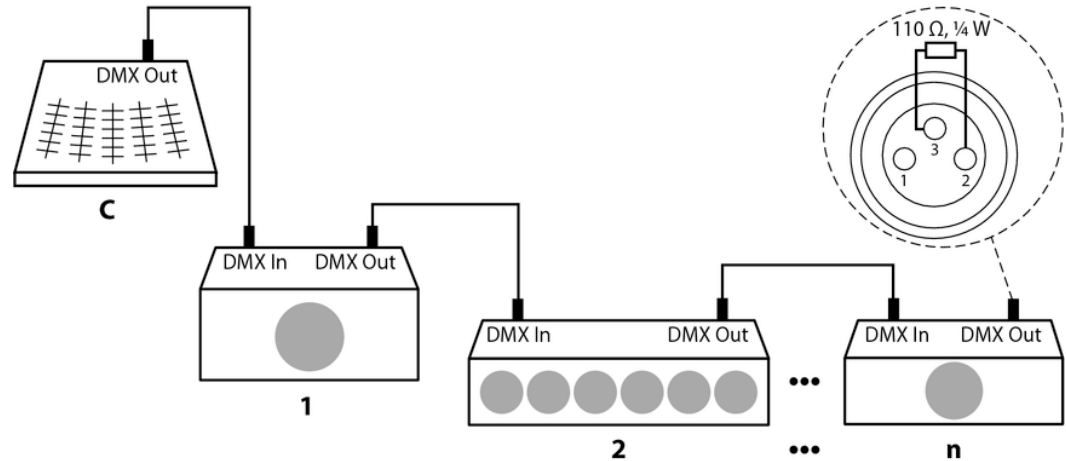

### **Connections in master/slave mode**

When you configure a group of devices in master/slave mode, the first unit will control the other units for an automatic, sound-activated, synchronized show. This function is ideal when you want to start a show immediately. Connect the DMX output of the master device to the DMX input of the first slave device. Then connect the DMX output of the first slave device to the DMX input of the second slave device and so on.

## 6 Connections and controls

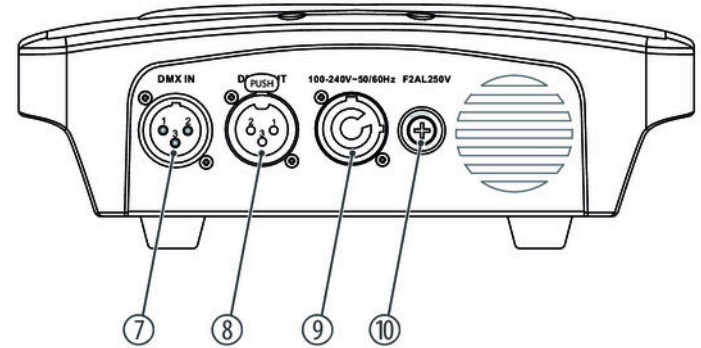
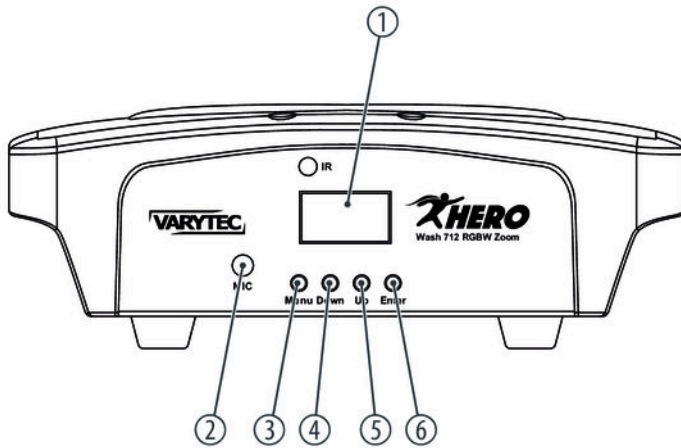

1	Display
2	Built-in microphone for sound control
3	<i>[MENU]</i> Activates the main and the settings menu and toggles between menu items. Closes an open submenu without saving any changes.
4	<i>[DOWN]</i> Decreases the displayed value by one.
5	<i>[UP]</i> Increases the displayed value by one.
6	<i>[ENTER]</i> Selects an option of the respective operating mode, confirms the set value.
7	<i>[DMX IN]</i> DMX input.
8	<i>[DMX OUT]</i> DMX output

9	Lockable input socket (Power Twist) for mains power supply
---	--

10	Fuse holder
----	-------------

## 7 Operating

### 7.1 Starting the device



#### **CAUTION!**

#### **Risk of injury due to movements of the device**

The head of the device can move quickly (pan, tilt) and can produce very bright light. This is also valid immediately after you turn on the device, when the device operates in automatic mode or under remote control and when you turn off a DMX controller that is connected to the device. Persons staying near the device could be injured or frightened.

Before you turn on the device and during the operation, always ensure that nobody stays close to the device. If work has to be performed in the area of movement or in the near vicinity of the device, it must remain turned off.

Connect the device to the power supply to start operation. After a few seconds, the fans start to work, the head moves to the home positions for rotation (pan) and inclination (tilt). After a few more seconds, the display shows '001'. The device is now ready for operation.

## 7.2 Main menu

Press *[ENTER]* to activate the main menu.

Use *[UP]* and *[DOWN]* to change the respectively indicated value. When the display shows the desired value press *[ENTER]*.

To exit the menu item without making changes, press *[MENU]*.

If you don't press any button for 35 seconds the display turns off. Then press *[MENU]*, *[ENTER]*, *[UP]* or *[DOWN]* briefly to turn it on again.

All previous settings are retained even when you switch the device off and disconnect it from the mains.

### DMX address

Use the 'DMX Address' menu to set the DMX address.

Press *[ENTER]* to activate the main menu and use *[UP]* or *[DOWN]* until the display shows 'DMX Address'. Confirm the selection with *[ENTER]* and use *[UP]* or *[DOWN]* to select a value between 1 and 512 to set the desired DMX address.

When the display shows the desired value confirm the setting with *[ENTER]*. To exit the menu item without making changes, press *[MENU]*.

Make sure that this number matches the configuration of your DMX controller.

### **DMX mode**

Use the '*DMX Channel*' menu to set the DMX mode.

Press *[ENTER]* to activate the main menu and use *[UP]* or *[DOWN]* until the display shows '*DMX Channel*'. Confirm the setting with *[ENTER]* and use *[UP]* or *[DOWN]* to select one of two DMX modes (8-channel mode or 15-channel mode, display shows '*DMX 08 Ch*' or '*DMX 15 Ch*').

When the display shows the desired value confirm the setting with *[ENTER]*. To exit the menu item without making changes, press *[MENU]*.



## Operating mode

Use the *'Running Mode'* menu to set the operating mode.

Press *[ENTER]* to activate the main menu and use *[UP]* or *[DOWN]* until the display shows *'Running Mode'*. Confirm the selection with *[ENTER]* and use *[UP]* or *[DOWN]* to select one of the four operating modes (*'DMX'*, *'Auto'*, *'Sound'*, *'Slave'*).

Operating mode	Function
<i>'DMX'</i>	DMX control In this mode the device is controlled via a DMX controller.
<i>'Auto'</i>	Auto programmes In this mode, the unit plays the preprogrammed shows.
<i>'Sound'</i>	Sound control In this mode, the unit follows the rhythm of the background music or sounds detected by the built-in microphone.
<i>'Slave'</i>	Slave function In this mode, the device follows exactly the operation of the master that it is connected to.

When the display shows the desired value confirm the setting with *[ENTER]*. To exit the menu item without making changes, press *[MENU]*.

### **Auto programmes**

Use the *'Programs'* to select one of the preprogrammed shows.

Press *[ENTER]* to activate the main menu and use *[UP]* or *[DOWN]* until the display shows *'Programs'*. Confirm the setting with *[ENTER]* and use *[UP]* or *[DOWN]* to select one of the eight preprogrammed shows (display shows *'Program1'* ... *'Program8'*).

When the display shows the desired value confirm the setting with *[ENTER]*. The device plays the selected show as an endless loop. To exit the menu item without making changes, press *[MENU]*.

## Settings

Use the *'Settings'* menu to adjust the device parameters.

Press *[ENTER]* to activate the main menu and use *[UP]* or *[DOWN]* until the display shows *'Settings'*. Confirm the selection with *[ENTER]* and use *[UP]* or *[DOWN]* to select the desired parameter.

Parameter	Function
<i>'Pan Rev'</i>	Pan inversion Use <i>[UP]</i> or <i>[DOWN]</i> to select <i>'YES'</i> (reverse rotation) or <i>'NO'</i> (normal rotation).
<i>'Tilt Rev'</i>	Tilt inversion Use <i>[UP]</i> or <i>[DOWN]</i> to select <i>'YES'</i> (reverse direction of inclination) or <i>'NO'</i> (normal direction of inclination).
<i>'Display Rev'</i>	Display inversion Use <i>[UP]</i> or <i>[DOWN]</i> to select <i>'YES'</i> (text in the display appears upside down) or <i>'NO'</i> (text in the display appears normal).

Parameter	Function
'Sensitivity'	Microphone sensitivity Use <i>[UP]</i> or <i>[DOWN]</i> to select a value from 0 (sound control off) to 100 (microphone sensitivity high).
'Dmx Fail'	Behaviour on DMX control failure Use <i>[UP]</i> or <i>[DOWN]</i> to select 'OFF' (blackout in case of DMX failure) or 'HOLD' (last DMX signal is being held).
'Calibration'	Calibrating Detailed information about this menu item can be found under ↪ 'Calibrating' on page 37.
'Factory Reset'	Reset to factory defaults Use <i>[UP]</i> or <i>[DOWN]</i> to select 'YES' (factory reset) or 'NO' (no factory reset).
'Reset Motor'	Resetting the motor

When the display shows the desired value confirm the setting with *[ENTER]*. To exit the menu item without making changes, press *[MENU]*.

## Calibrating

Use the 'Calibration' menu to adjust the start parameters of the device.

Press [ENTER] to activate the main menu and use [UP] or [DOWN] until the display shows 'Settings'. Confirm the selection with [ENTER] and use [UP] or [DOWN] to select the submenu 'Calibration'.

Confirm the selection with [ENTER]. The device prompts you to enter a password. Press [UP] or [DOWN] repeatedly until the display shows '018' and confirm the selection with [ENTER].

Use [UP] or [DOWN] to select the desired parameter you want to set.

Parameter	Function
'All To Origin'	Resets all parameters of the calibration to factory settings.
'Pan'	Sets the home position of the rotation.
'Tilt'	Sets the home position of the inclination movement.
'Red'	Sets the initial intensity for red.
'Green'	Sets the initial intensity for green.
'Blue'	Sets the initial intensity for blue.

Parameter	Function
'White'	Sets the initial intensity for white.
'Zoom'	Sets the output setting for the zoom.

When the display shows the desired parameter confirm the setting with *[ENTER]*. Use *[UP]* or *[DOWN]* to select the desired value for the selected parameter (0 ... 120 for Pan and Tilt, 0 ... 255 for Red, Green, Blue, White and Zoom) and confirm the setting with *[ENTER]*. To exit the menu item without making changes, press *[MENU]*.

### System information

Use the 'System Info' menu to call up information about the system.

Press *[ENTER]* to activate the main menu and use *[UP]* or *[DOWN]* until the display shows 'System Info'. Confirm the selection with *[ENTER]*.

The display shows the current software version, the current operating mode and the DMX start address.

Menu overview

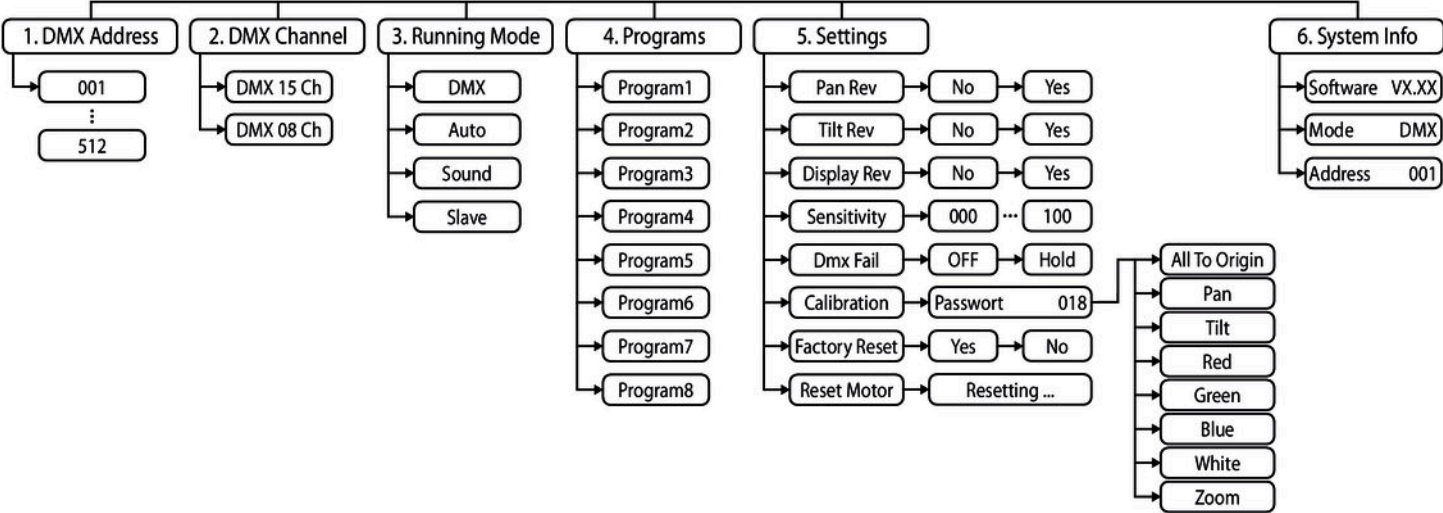

### 7.3 Functions in 8-channel DMX mode

Channel	Value	Function
1	0...255	Rotation (pan) (0° up to the maximum value of the Pan area. middle position: 128)
2	0...255	Inclination (tilt) (0° up to the maximum value of the Tilt area. middle position: 128)
3	0...255	Speed of pan and tilt movement, fast (0) to slow (255)
4	0...255	Dimmer intensity from dark (0) to bright (255)
5	Shutter (channel 4 must be set to a value between 1 and 255, channel 6 to a value between 11 and 255)	
	0...9	Open
	10...250	Stroboscope, increasing speed (0 ... 20 Hz)
	251...255	Open
6	Colour macros (channel 4 must be set to a value between 1 and 255)	
	0...10	No function
	11...20	Red



Channel	Value	Function
	21...30	Green
	31...40	Blue
	41...50	White
	51...60	Red, white
	61...70	Green, white
	71...80	Blue, white
	81...90	Red, green
	91...100	Green, blue
	101...110	Red, blue
	111...120	Red, green, white
	121...130	Green, blue, white
	131...140	Red, blue, white
	141...150	Red, green, blue, white

Channel	Value	Function
	151...200	Colour sequence, increasing speed
	201...255	Colour transition (fade), increasing speed
7	0...255	Gradual zoom adjustment from small to large (6° ... 36°)
8	Auto programmes (channel 4 must be set to a value between 1 and 255, channel 6 to a value between 11 and 255)	
	0...10	No function
	11...20	preprogrammed automatic show 1
	21...30	preprogrammed automatic show 2
	31...40	preprogrammed automatic show 3
	41...50	preprogrammed automatic show 4
	51...60	preprogrammed automatic show 5
	61...70	preprogrammed automatic show 6
	71...80	preprogrammed automatic show 7

Channel	Value	Function
	81...90	preprogrammed automatic show 8
	91...230	Sound control, from sound control off to high microphone sensitivity
	231...240	Reset, if the value is transmitted for at least 3 seconds
	241...255	No function

## 7.4 Functions in 15-channel DMX mode

Channel	Value	Function
1	0...255	Rotation (pan) (0° up to the maximum value of the Pan area. middle position: 128)
2	0...255	Fine adjustment rotation (pan) 16 bit
3	0...255	Inclination (tilt) (0° up to the maximum value of the Tilt area. middle position: 128)
4	0...255	Fine adjustment inclination (pan) 16 bit

Channel	Value	Function
5	0...255	Speed of rotation (pan) and inclination (tilt), fast (0) to slow (255)
6	0...255	Dimmer intensity from dark (0) to bright (255)
7	Shutter (channels 6 and 8 as well as channels 9, 10, or 11 must be set to a value between 1 and 255, channel 13 to a value between 11 and 255)	
	0...9	Open
	10...250	Stroboscope, increasing speed (0 ... 20 Hz)
	251...255	Open
8	0...255	Intensity Red (0 % to 100 %), if channel 6 = 1 ... 255
9	0...255	Intensity Green (0 % to 100 %), if channel 6 = 1 ... 255
10	0...255	Intensity Blue (0 % to 100 %), if channel 6 = 1 ... 255
11	0...255	Intensity White (0 % to 100 %), if channel 6 = 1 ... 255
12	0...255	Colour temperature (0 % to 100 %)
13	Colour macros (channel 6 must be set to a value between 1 and 255)	

Channel	Value	Function
	0...10	No function
	11...20	Red
	21...30	Green
	31...40	Blue
	41...50	White
	51...60	Red, white
	61...70	Green, white
	71...80	Blue, white
	81...90	Red, green
	91...100	Green, blue
	101...110	Red, blue
	111...120	Red, green, white
	121...130	Green, blue, white

Channel	Value	Function
	131...140	Red, blue, white
	141...150	Red, green, blue, white
	151...200	Colour sequence, increasing speed
	201...255	Colour transition (fade), increasing speed
14	Gradual zoom adjustment from small to large (6° ... 36°)	
15	Auto programmes (channel 6 must be set to a value between 1 and 255, channel 13 to a value between 11 and 255)	
	0...10	No function
	11...20	preprogrammed automatic show 1
	21...30	preprogrammed automatic show 2
	31...40	preprogrammed automatic show 3
	41...50	preprogrammed automatic show 4
	51...60	preprogrammed automatic show 5

---

Channel	Value	Function
	61...70	preprogrammed automatic show 6
	71...80	preprogrammed automatic show 7
	81...90	preprogrammed automatic show 8
	91...230	Sound control, from sound control off to high microphone sensitivity
	231...240	Reset, if the value is transmitted for at least 3 seconds
	241...255	No function

## 8 Technical specifications

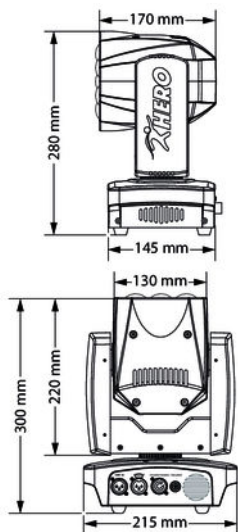

Light source		7 × RGBW 4-in-1 LED, 12 W
Optical properties	Beam angle	6°...36°, adjustable via motorised zoom
Rotation angle (pan), max.		540°
Inclination angle (tilt), max.		190°
Control		DMX Buttons and display on the unit
Number of DMX channels		8, 15
Input connections	Voltage supply	Lockable input socket (Power Twist)
	DMX control	XLR chassis socket, 3-pin
Output connections	DMX control	XLR chassis socket, 3-pin
Power consumption		max. 80 W



Operating supply voltage		100 – 240 V ~ 50/60 Hz
Fuse		5 mm × 20 mm, 2 A, 250 V, fast-acting
Protection class		IP20
Mounting options		hanging, standing
Dimensions (W × H × D)		215 mm × 300 mm × 145 mm
Weight		4.2 kg
Ambient conditions	Temperature range	0 °C...40 °C
	Relative humidity	50 %, non-condensing

**Further information**

Illuminant type	LED
Light output	84 W
Colour mixture	RGBW
Motorized zoom	Yes

## 9 Troubleshooting



### **NOTICE!**

#### **Possible data transmission errors**

For error-free operation make use of dedicated DMX cables and do not use ordinary microphone cables.

Never connect the DMX input or output to audio devices such as mixers or amplifiers.

In the following we list a few common problems that may occur during operation. We give you some suggestions for easy troubleshooting:

Symptom	Remedy
The unit does not work, no light, the fan does not run	Check the mains connection and the main fuse.
No response to the DMX controller	1. Check the DMX connectors and cables for proper connection.
	2. Check the address settings and the DMX polarity.
	3. Try using another DMX controller.
	4. Check to see if the DMX cables run near or alongside to high voltage cables that may cause damage or interference to DMX interface circuits.

If the procedures recommended above do not succeed, please contact our Service Center. You can find the contact information at [www.thomann.de](http://www.thomann.de).

## 10 Cleaning

### Optical lenses

Clean the optical lenses, that are accessible from the outside, regularly in order to optimize the light output. The frequency of cleaning depends on the operating environment: wet, smoky or particularly dirty surroundings can cause more accumulation of dirt on the optics of the device.

- Clean with a soft cloth using our lamp and lens cleaner (item no. 280122).
- Always dry the parts carefully.

### Fan grids

The fan grids of the device must be cleaned of any contamination, such as dust, etc. on a regular basis. Before cleaning, switch off the device and disconnect mains-operated devices from the mains. Only use pH-neutral, solvent-free and non-abrasive cleaning agents. Clean the unit with a slightly damp lint-free cloth.

## 11 Protecting the environment

### Disposal of the packaging material



For the transport and protective packaging, environmentally friendly materials have been chosen that can be supplied to normal recycling.

Ensure that plastic bags, packaging, etc. are properly disposed of.

Do not just dispose of these materials with your normal household waste, but make sure that they are collected for recycling. Please follow the notes and markings on the packaging.

### Disposal of your old device



This product is subject to the European Waste Electrical and Electronic Equipment Directive (WEEE) in its currently valid version. Do not dispose with your normal household waste.

Dispose of this device through an approved waste disposal firm or through your local waste facility. When discarding the device, comply with the rules and regulations that apply in your country. If in doubt, consult your local waste disposal facility.





