



VP-1 DMX
Video BiLight Panel

LED spotlight

Musikhaus Thomann
Thomann GmbH
Hans-Thomann-Straße 1
96138 Burgebrach
Germany
Telephone: +49 (0) 9546 9223-0
E-mail: info@thomann.de
Internet: www.thomann.de

25.10.2019, ID: 457073

Table of contents

1	General notes	6
	1.1 Further information.....	7
	1.2 Notational conventions.....	8
	1.3 Symbols and signal words.....	9
2	Safety instructions	11
3	Features	17
4	Installation	18
5	Starting up	22
6	Connections and controls	25
7	Operating	29
	7.1 Starting the device.....	29
	7.2 Main menu.....	29
	7.3 Menu overview.....	35
	7.4 Functions in 1-channel DMX mode.....	36
	7.5 Functions in 2-channel DMX mode (mode 1).....	36

7.6	Functions in 2-channel DMX mode (mode 2).....	37
7.7	Functions in 3-channel DMX mode.....	37
7.8	Functions in 4-channel DMX mode.....	38
8	Technical specifications.....	39
9	Plug and connection assignment.....	42
10	Troubleshooting.....	43
11	Cleaning.....	45
12	Protecting the environment.....	46



VP-1 DMX Video BiLight Panel
LED spotlight

1 General notes

This manual contains important instructions for the safe operation of the unit. Read and follow the safety instructions and all other instructions. Keep the manual for future reference. Make sure that it is available to all those using the device. If you sell the unit please make sure that the buyer also receives this manual.

Our products are subject to a process of continuous development. Thus, they are subject to change.

1.1 Further information

On our website (www.thomann.de) you will find lots of further information and details on the following points:

Download	This manual is also available as PDF file for you to download.
Keyword search	Use the search function in the electronic version to find the topics of interest for you quickly.
Online guides	Our online guides provide detailed information on technical basics and terms.
Personal consultation	For personal consultation please contact our technical hotline.
Service	If you have any problems with the device the customer service will gladly assist you.

1.2 Notational conventions

This manual uses the following notational conventions:

Letterings

The letterings for connectors and controls are marked by square brackets and italics.

Examples: *[VOLUME]* control, *[Mono]* button.

Displays

Texts and values displayed on the device are marked by quotation marks and italics.

Examples: *'24ch'*, *'OFF'*.

Cross-references





References to other locations in this manual are identified by an arrow and the specified page number. In the electronic version of the manual, you can click the cross-reference to jump to the specified location.

Example: See ↗ *'Cross-references'* on page 8.

1.3 Symbols and signal words

In this section you will find an overview of the meaning of symbols and signal words that are used in this manual.

Signal word	Meaning
DANGER!	This combination of symbol and signal word indicates an immediate dangerous situation that will result in death or serious injury if it is not avoided.
WARNING!	This combination of symbol and signal word indicates a possible dangerous situation that can result in death or serious injury if it is not avoided.
NOTICE!	This combination of symbol and signal word indicates a possible dangerous situation that can result in material and environmental damage if it is not avoided.

Warning signs	Type of danger
	Warning – high-voltage.
	Warning – dangerous optical radiation.
	Warning – suspended load.
	Warning – danger zone.

2 Safety instructions

Intended use

This device is intended for use as an electronic lighting effect by means of LED technology. The device is designed for professional use and is not suitable for use in households. Use the device only as described in this user manual. Any other use or use under other operating conditions is considered to be improper and may result in personal injury or property damage. No liability will be assumed for damages resulting from improper use.

This device may be used only by persons with sufficient physical, sensorial, and intellectual abilities and having corresponding knowledge and experience. Other persons may use this device only if they are supervised or instructed by a person who is responsible for their safety.

Extend the life of the device by regular breaks in operation and avoid switching it on and off frequently. This device is not suitable for continuous use.

Safety



DANGER!

Danger for children

Ensure that plastic bags, packaging, etc. are disposed of properly and are not within reach of babies and young children. Choking hazard!

Ensure that children do not detach any small parts (e.g. knobs or the like) from the unit. They could swallow the pieces and choke!

Never let children unattended use electrical devices.



DANGER!

Electric shock caused by high voltages inside

Within the device there are areas where high voltages may be present. Never remove any covers.

There are no user-serviceable parts inside.

Do not use the device if covers, protectors or optical components are missing or damaged.



WARNING!

Eye damage caused by high light intensity

Never look directly into the light source.



WARNING!

Risk of epileptic shock

Strobe lighting can trigger seizures in photosensitive epilepsy. Sensitive persons should avoid looking at strobe lights.



NOTICE!

Risk of fire

Do not block areas of ventilation. Do not install the device near any direct heat source. Keep the device away from naked flames.



NOTICE!

Operating conditions

This device has been designed for indoor use only. To prevent damage, never expose the device to any liquid or moisture. Avoid direct sunlight, heavy dirt, and strong vibrations.

Only operate the device within the ambient conditions specified in the chapter 'Technical specifications' of this user manual. Avoid heavy temperature fluctuations and do not switch the device on immediately after it was exposed to temperature fluctuations (for example after transport at low outside temperatures).

Dust and dirt inside can damage the unit. When operated in harmful ambient conditions (dust, smoke, nicotine, fog, etc.), the unit should be maintained by qualified service personnel at regular intervals to prevent overheating and other malfunction.



NOTICE!

Power supply

Before connecting the device, ensure that the input voltage (AC outlet) matches the voltage rating of the device and that the AC outlet is protected by a residual current circuit breaker. Failure to do so could result in damage to the device and possibly injure the user.

Unplug the device before electrical storms occur and when it is unused for long periods of time to reduce the risk of electric shock or fire.



NOTICE!

Risk of overheating

The distance between light output and the illuminated surface must be more than 1.5 m (19.7in).

Provide sufficient ventilation.

The ambient temperature must always be below 40 °C (104 °F).



NOTICE!

Possible damage due to installation of a wrong fuse

The use of different types of fuses can cause serious damage to the unit. Fire hazard!

Only fuses of the same type may be used.

3 Features

The LED spotlight with variable colour temperature is particularly suitable for lighting tasks during video shooting in reports on the road or in the studio.

Special features of the device:

- High CRI for large and even illumination
- Control via DMX and via buttons and display on the unit
- Stand-alone operation or combined operation for complex lighting situations
- Lightweight design for use on the go
- Optional operation via V-mount batteries (not included)

For technological reasons, the light output of LEDs decreases over their lifetime. This effect increases with higher operating temperature. You can extend the service life of the illuminants by providing adequate ventilation and operating the LEDs with the lowest possible brightness.

4 Installation

Unpack and carefully check that there is no transportation damage before using the unit. Keep the equipment packaging. To fully protect the device against vibration, dust and moisture during transportation or storage use the original packaging or your own packaging material suitable for transport or storage, respectively.

You can install the device standing or hanging. When in use, the device must be mounted at a solid surface or clamped to an approved truss.

Work from a stable platform whenever you install or move the device or when you perform any kind of maintenance. Block access under the work area.

**WARNING!****Risk of injury caused by falling objects**

Make sure that the installation complies with the standards and rules that apply in your country. Always secure the device with a secondary safety attachment, such as a safety cable or a safety chain.

Secure the barn door with a safety cable on the spotlight after installation. The safety cable must run outside the barn door and must not interfere with the light emission.

**NOTICE!****Risk of overheating**

The distance between light output and the illuminated surface must be more than 1.5 m (19.7in).

Provide sufficient ventilation.

The ambient temperature must always be below 40 °C (104 °F).



NOTICE!

Use of stands

When mounting the device onto a stand, ensure that the stand is in a safe and stable position and that the weight of the device does not exceed the maximum permissible load capacity of the stand.



NOTICE!

Possible data transmission errors

For error-free operation make use of dedicated DMX cables and do not use ordinary microphone cables.

Never connect the DMX input or output to audio devices such as mixers or amplifiers.



Please note that this device must not be connected to a dimmer.

5 Starting up

Create all connections while the device is off. Use the shortest possible high-quality cables for all connections. Take care when running the cables to prevent tripping hazards.

Connections in DMX mode

Connect the DMX input of the device to the DMX output of a DMX controller or another DMX device. Connect the output of the first DMX device to the input of the second one, and so on to form a daisy chain. Always ensure that the output of the last DMX device in the daisy chain is terminated with a resistor ($110\ \Omega$, $\frac{1}{4}\text{ W}$).

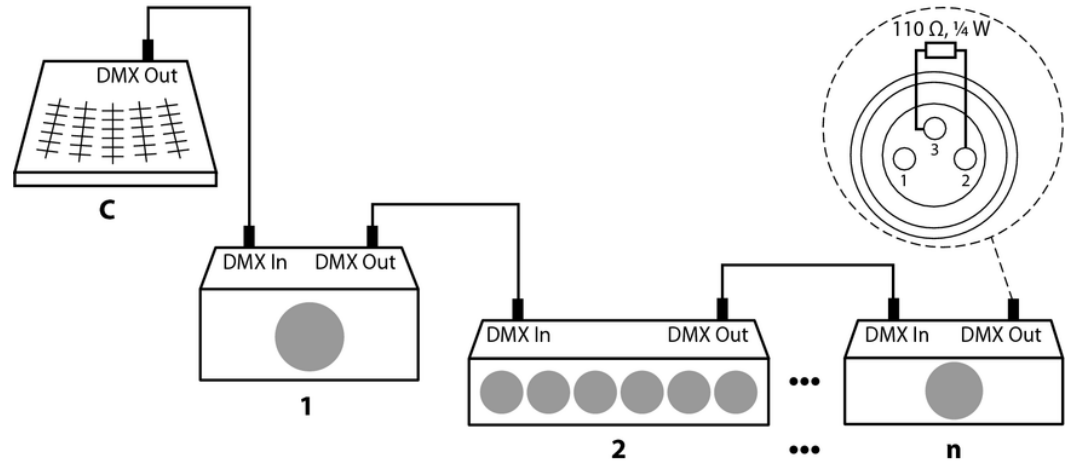

Connections in master/slave mode

When you configure a group of devices in master/slave mode, the first unit will control the other units for an automatic, sound-activated, synchronized show. This function is ideal when you want to start a show immediately. Connect the DMX output of the master device to the DMX input of the first slave device. Then connect the DMX output of the first slave device to the DMX input of the second slave device and so on.

6 Connections and controls

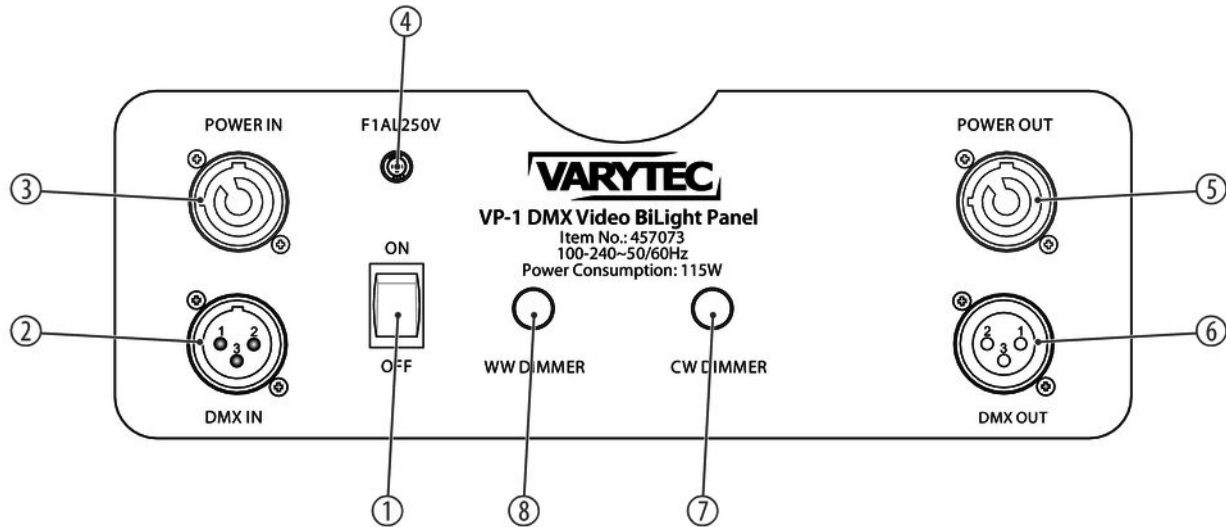

1	Main switch. Turns the device on and off.
2	<i>[DMX IN]</i> : DMX input socket, 3-pin
3	<i>[POWER IN]</i> : Lockable input socket (Power Twist) for powering the device
4	Fuse holder
5	<i>[POWER OUT]</i> : Lockable output socket (Power Twist) for powering a connected device
6	<i>[DMX OUT]</i> : DMX output socket, 3-pin
7	<i>[CW DIMMER]</i> : Dimmer for cold white
8	<i>[WW DIMMER]</i> : Dimmer for warm white

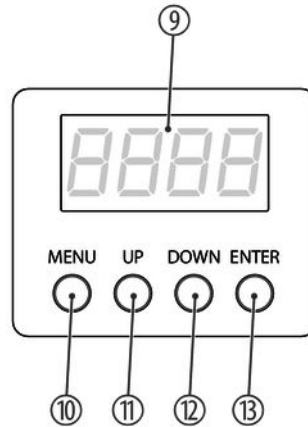

9 Display

10 *[MENU]*: Activates the main menu and toggles between menu items.

11 *[UP]*: Increases the displayed value by one.

- | | |
|----|--|
| 12 | <i>[DOWN]</i> : Decreases the displayed value by one. |
| 13 | <i>[ENTER]</i> : Selects an option of the respective operating mode. |

7 Operating

7.1 Starting the device

Connect the device to the power supply to start operation. The display shows the menu overview.

7.2 Main menu

DMX address

This setting is only relevant if the device is controlled via a DMX controller.

Press *[UP]* or *[DOWN]* until the display shows 'DMX Address' and press *[ENTER]*. Use *[UP]* or *[DOWN]* to select the desired DMX address between 1 ('001') and 512 ('A512') and press *[ENTER]*. Press *[MENU]* to return to the parent menu level.

Operating mode 'DMX'

This setting is only relevant if the device is controlled via a DMX controller.

Press *[UP]* or *[DOWN]* until the display shows 'DMX CH Mode' and press *[ENTER]*. Use *[UP]* or *[DOWN]* to select the desired DMX mode ('1CH', '2CH_1', '2CH_2', '3CH', '4CH') and press *[ENTER]*. Press *[MENU]* to return to the parent menu level.

Slave mode

Press *[UP]* or *[DOWN]* until the display shows 'Slave Mode' and press *[ENTER]*. Use *[UP]* or *[DOWN]* so select 'ON' to activate Slave mode and press *[ENTER]*. The device is now working in slave mode, i.e. it will exactly copy the movement of the controlling master device, correct wiring provided.

Use *[UP]* or *[DOWN]* to select 'OFF' to deactivate Slave mode and press *[ENTER]*. Press *[MENU]* to return to the parent menu level.

This setting is only relevant if the device is not controlled via DMX.

Colour temperature and light behaviour

Press *[UP]* or *[DOWN]* until the display shows 'Static Mode' and press *[ENTER]*. Use *[UP]* or *[DOWN]* to select the desired parameter and press *[ENTER]*. Use *[UP]* or *[DOWN]* to select the desired value and press *[ENTER]*. Press *[MENU]* to return to the parent menu level.

In order to use this operating mode, the controls *[CW DIMMER]* and *[WW DIMMER]* must be fully open.

The following parameters are available:

Display	Function	Value range
Brightness	Overall brightness	0...255
Strobe	Stroboscope frequency from off (0) to fast (30)	0...30
Warm White	Intensity warm white	0...255
Cold White	Intensity cold white	0...255

Display lighting

Press *[UP]* or *[DOWN]* until the display shows *'Backlight'* and press *[ENTER]*. Use *[UP]* or *[DOWN]* to select *'ON'* to permanently activate the display lighting and press *[ENTER]*. Use *[UP]* or *[DOWN]* to select *'10S OFF'* to deactivate the display lighting and press *[ENTER]*. The display turns dark after 10 seconds. Press *[MENU]* to return to the parent menu level.

Behaviour on DMX control failure

Press *[UP]* or *[DOWN]* until the display shows *'DMX Fail'* and press *[ENTER]*. Use *[UP]* or *[DOWN]* to select *'Hold'* if the last setting is to be retained if the DMX control unit fails, then press *[ENTER]*. Use *[UP]* or *[DOWN]* to select *'Black'* if the spotlight is to be blacked out if the DMX control unit fails, then press *[ENTER]*. Press *[MENU]* to return to the parent menu level.

Dimmer curve

Press *[UP]* or *[DOWN]* until the display shows *'Dimmer Curve'* and press *[ENTER]*. Use *[UP]* or *[DOWN]* to select the desired parameter and press *[ENTER]*. Press *[MENU]* to return to the parent menu level.

Display	Meaning
<i>'Linear'</i>	Linear course
<i>'Exponential'</i>	Exponential course
<i>'Logarithmic'</i>	Logarithmic course
<i>'S-curve'</i>	S-curve shaped course

Dimmer settings

Press *[UP]* or *[DOWN]* until the display shows *'Dimmer Response'* and press *[ENTER]*. Select *'Led'* to enable the dimmer settings for the LEDs and press *[ENTER]*. Use *[UP]* or *[DOWN]* to select *'Lamp'* to select the dimmer settings for the imitation of incandescent light and press *[ENTER]*. Press *[MENU]* to return to the parent menu level.

Software version

Press *[UP]* or *[DOWN]* until the display shows *'Firmware'* and press *[ENTER]*. The current software version of the device will appear on the display.

Reset

Press *[UP]* or *[DOWN]* until the display shows 'Reset' and press *[ENTER]*. The device is reset to factory defaults after 5 seconds.

To cancel the factory reset, press any key. Press *[MENU]* to return to the parent menu level.

7.3 Menu overview

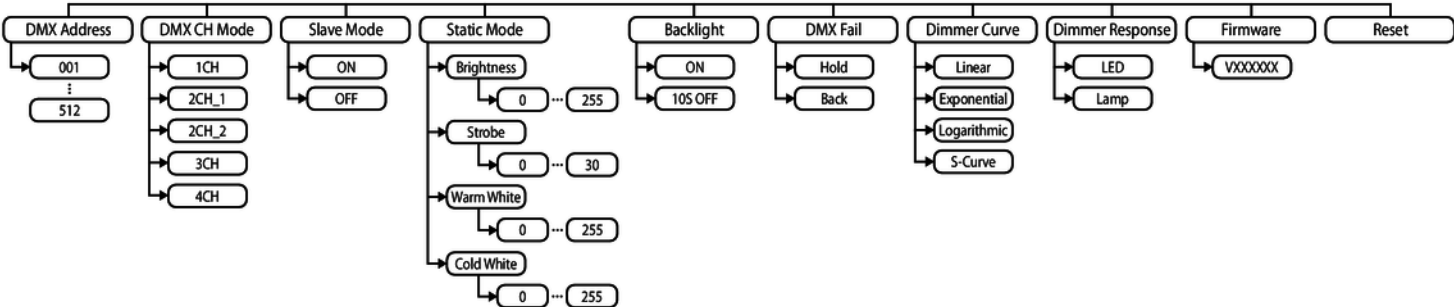

7.4 Functions in 1-channel DMX mode

Channel	Value	Function
1	000 ... 255	Dimmer (0 % to 100 %)

7.5 Functions in 2-channel DMX mode (mode 1)

Channel	Value	Function
1	000 ... 255	Dimmer (0 % to 100 %)
2	000 ... 005	Colour temperature off to maximum, depending on the dimmer setting
	006 ... 255	3200 K ... 7800 K

7.6 Functions in 2-channel DMX mode (mode 2)

Channel	Value	Function
1	000 ... 255	Warm white (0 % to 100 %)
2	000 ... 255	Cold white (0 % to 100 %)

7.7 Functions in 3-channel DMX mode

Channel	Value	Function
1	000 ... 255	Dimmer (0 % to 100 %)
2	000 ... 005	Open strobe
	006 ... 255	Strobe effect, increasing speed 1 Hz ... 30 Hz
3	000 ... 005	Colour temperature off to maximum, depending on the dimmer setting
	006 ... 255	3200 K ... 7800 K

7.8 Functions in 4-channel DMX mode

Channel	Value	Function
1	000 ... 255	Dimmer (0 % to 100 %)
2	000 ... 005	Open strobe
	006 ... 255	Strobe effect, increasing speed 1 Hz ... 30 Hz
3	000 ... 255	Warm white (0 % to 100 %)
4	000 ... 255	Cold white (0 % to 100 %)

8 Technical specifications

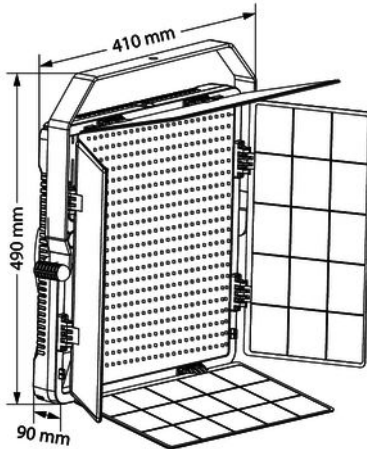

Light source	288 × CW and 288 × WW 2in1 SMD LED (type 2835), 0.3 W	
Light source properties	Colour temperature	2800 ...6500 K, infinitely selectable
	Colour rendering index	CRI >90
Optical properties	Beam angle	180°
	Stroboscope	0 Hz ... 30 Hz
Control	DMX	
	Buttons and display on the unit	
Number of DMX channels	1, 2a, 2b, 3, 4	
Input connections	Voltage supply	Lockable input socket (Power Twist)
	DMX control	XLR chassis socket, 3-pin

Output connections	Voltage supply	Lockable output socket (Power Twist)
	DMX control	XLR chassis socket, 3-pin
Power consumption	115 W	
Operating supply voltage	100 – 240 V ~ 50/60 Hz	
Fuse	5 mm × 20 mm, 1 A, 250 V, fast-acting	
Protection class	IP20	
Mounting options	hanging, standing	
Dimensions (W × H × D)	410 mm × 490 mm × 90 mm	
Weight	5.5 kg	
Ambient conditions	Temperature range	0 °C...40 °C
	Relative humidity	50 %, non-condensing

Further information

Construction	Flood light
Dispersion characteristics	symmetrical
Power, max.	170 W
Colour mixing / colour temperature	CW / WW
LED type	Unicoloured
Fanless	No

9 Plug and connection assignment

Introduction

This chapter will help you select the right cables and plugs to connect your valuable equipment so that a perfect light experience is guaranteed.

Please take our tips, because especially in 'Sound & Light' caution is indicated: Even if a plug fits into a socket, the result of an incorrect connection may be a destroyed DMX controller, a short circuit or 'just' a not working light show!

DMX connections

The unit offers a 3-pin XLR socket for DMX output and a 3-pin XLR plug for DMX input. Please refer to the drawing and table below for the pin assignment of a suitable XLR plug.



Pin	Configuration
1	Ground, shielding
2	Signal inverted (DMX-, 'cold signal')
3	Signal (DMX+, 'hot signal')

10 Troubleshooting



NOTICE!

Possible data transmission errors

For error-free operation make use of dedicated DMX cables and do not use ordinary microphone cables.

Never connect the DMX input or output to audio devices such as mixers or amplifiers.

In the following we list a few common problems that may occur during operation. We give you some suggestions for easy troubleshooting:

Symptom	Remedy
The unit does not work, no light, the display is dark	Check the mains connection and the main fuse.
Apparently no function despite proper power supply	Check if the unit is in DMX mode or in 'slave' mode. If so, check the unit in another mode.
No response to the DMX controller	<ol style="list-style-type: none">1. Check whether the DMX controller is switched on. Check the DMX connectors and cables for proper connection.2. Check the address settings and the DMX polarity.3. Try using another DMX controller.4. Check whether the DMX cables run near or parallel to high-voltage cables that may cause damage or interference to a DMX interface circuit.

If the procedures recommended above do not succeed, please contact our Service Center. You can find the contact information at www.thomann.de.

11 Cleaning

Optical lenses

Clean the optical lenses, that are accessible from the outside, regularly in order to optimize the light output. The frequency of cleaning depends on the operating environment: wet, smoky or particularly dirty surroundings can cause more accumulation of dirt on the optics of the device.

- Clean with a soft cloth using our lamp and lens cleaner (item no. 280122).
- Always dry the parts carefully.

Fan grids

The fan grids of the device must be cleaned on a regular basis to remove dust and dirt. Before cleaning, switch off the device and disconnect AC-powered devices from the mains. Use a lint-free damp cloth for cleaning. Never use solvents or alcohol for cleaning.

12 Protecting the environment

Disposal of the packaging material



For the transport and protective packaging, environmentally friendly materials have been chosen that can be supplied to normal recycling.

Ensure that plastic bags, packaging, etc. are properly disposed of.

Do not just dispose these materials with your normal household waste, but make sure that they are fed to a recovery. Please follow the notes and markings on the packaging.

Disposal of batteries



Batteries must not be disposed of as domestic waste or thrown into fire. Dispose of the batteries according to national or local regulations regarding hazardous waste. To protect the environment, dispose of empty batteries at your retail store or at appropriate collection sites.

Disposal of your old device



This product is subject to the European Waste Electrical and Electronic Equipment Directive (WEEE) in its currently valid version. Do not dispose with your normal household waste.

Dispose this device through an approved waste disposal firm or through your local waste facility. When discarding the device, comply with the rules and regulations that apply in your country. If in doubt, consult your local waste disposal facility.

