



BEL6 IP Bar HEX  
LED bar

Musikhaus Thomann  
Thomann GmbH  
Hans-Thomann-Straße 1  
96138 Burgebrach  
Germany  
Telephone: +49 (0) 9546 9223-0  
E-mail: [info@thomann.de](mailto:info@thomann.de)  
Internet: [www.thomann.de](http://www.thomann.de)

06.05.2020, ID: 471167

# Table of contents

<b>1</b>	<b>General information</b> .....	<b>5</b>
	1.1 Further information.....	6
	1.2 Notational conventions.....	7
	1.3 Symbols and signal words.....	8
<b>2</b>	<b>Safety instructions</b> .....	<b>10</b>
<b>3</b>	<b>Features</b> .....	<b>18</b>
<b>4</b>	<b>Installation</b> .....	<b>19</b>
<b>5</b>	<b>Starting up</b> .....	<b>24</b>
<b>6</b>	<b>Connections and controls</b> .....	<b>26</b>
<b>7</b>	<b>Operating</b> .....	<b>33</b>
	7.1 Starting the device.....	33
	7.2 Main menu.....	34
	7.3 Menu overview.....	43
	7.4 Functions in 6-channel DMX mode.....	44
	7.5 Functions in 10-channel DMX mode.....	45

<b>8</b>	<b>Technical specifications.....</b>	<b>47</b>
<b>9</b>	<b>Plug and connection assignments.....</b>	<b>50</b>
<b>10</b>	<b>Troubleshooting.....</b>	<b>51</b>
<b>11</b>	<b>Cleaning.....</b>	<b>53</b>
<b>12</b>	<b>Protecting the environment.....</b>	<b>54</b>

# 1 General information

This user manual contains important information on the safe operation of the device. Read and follow all safety notes and all instructions. Save this manual for future reference. Make sure that it is available to all persons using this device. If you sell the device to another user, be sure that they also receive this manual.

Our products and user manuals are subject to a process of continuous development. We therefore reserve the right to make changes without notice. Please refer to the latest version of the user manual which is ready for download under [www.thomann.de](http://www.thomann.de).

## 1.1 Further information

On our website ([www.thomann.de](http://www.thomann.de)) you will find lots of further information and details on the following points:

Download	This manual is also available as PDF file for you to download.
Keyword search	Use the search function in the electronic version to find the topics of interest for you quickly.
Online guides	Our online guides provide detailed information on technical basics and terms.
Personal consultation	For personal consultation please contact our technical hotline.
Service	If you have any problems with the device the customer service will gladly assist you.

## 1.2 Notational conventions

This manual uses the following notational conventions:

### Letterings

The letterings for connectors and controls are marked by square brackets and italics.

**Examples:** *[VOLUME]* control, *[Mono]* button.

### Displays

Texts and values displayed on the device are marked by quotation marks and italics.

**Examples:** *'24ch'*, *'OFF'*.

### Cross-references

References to other locations in this manual are identified by an arrow and the specified page number. In the electronic version of the manual, you can click the cross-reference to jump to the specified location.





Example: See  *'Cross-references'* on page 7.

## 1.3 Symbols and signal words

In this section you will find an overview of the meaning of symbols and signal words that are used in this manual.

Signal word	Meaning
<b>DANGER!</b>	This combination of symbol and signal word indicates an immediate dangerous situation that will result in death or serious injury if it is not avoided.
<b>WARNING!</b>	This combination of symbol and signal word indicates a possible dangerous situation that can result in death or serious injury if it is not avoided.
<b>NOTICE!</b>	This combination of symbol and signal word indicates a possible dangerous situation that can result in material and environmental damage if it is not avoided.



Warning signs	Type of danger
	Warning – high-voltage.
	Warning – dangerous optical radiation.
	Warning – suspended load.
	Warning – danger zone.

## 2 Safety instructions

### **Intended use**

This device is intended for use as an electronic lighting effect by means of LED technology. The device is designed for professional use and is not suitable for use in households. Use the device only as described in this user manual. Any other use or use under other operating conditions is considered to be improper and may result in personal injury or property damage. No liability will be assumed for damages resulting from improper use.

This device may be used only by persons with sufficient physical, sensorial, and intellectual abilities and having corresponding knowledge and experience. Other persons may use this device only if they are supervised or instructed by a person who is responsible for their safety.

Extend the life of the device by regular breaks in operation and avoid switching it on and off frequently. This device is not suitable for continuous use.

**Safety****DANGER!****Danger for children**

Ensure that plastic bags, packaging, etc. are disposed of properly and are not within reach of babies and young children. Choking hazard!

Ensure that children do not detach any small parts (e.g. knobs or the like) from the unit. They could swallow the pieces and choke!

Never let children unattended use electrical devices.

**DANGER!****Electric shock caused by high voltages inside**

Within the device there are areas where high voltages may be present. Never remove any covers.

There are no user-serviceable parts inside.

Do not use the device if covers, protectors or optical components are missing or damaged.



### **DANGER!**

#### **Electric shock caused by short-circuit**

Always use proper ready-made insulated mains cabling (power cord) with a protective contact plug. Do not modify the mains cable or the plug. Failure to do so could result in electric shock/death or fire. If in doubt, seek advice from a registered electrician.



### **WARNING!**

#### **Eye damage caused by high light intensity**

Never look directly into the light source.



### **WARNING!**

#### **Risk of epileptic shock**

Strobe lighting can trigger seizures in photosensitive epilepsy. Sensitive persons should avoid looking at strobe lights.



**WARNING!**

**Incorrect handling of lithium batteries can result in injury**

In the event of a short circuit, overheating or mechanical damage, lithium batteries can cause severe injuries.

Follow the advice on the correct handling of lithium batteries in the present section.



**NOTICE!**

**Risk of fire**

Do not block areas of ventilation. Do not install the device near any direct heat source. Keep the device away from naked flames.



### **NOTICE!**

#### **Operating conditions**

This device has been designed for indoor use only. To prevent damage, never expose the device to any liquid or moisture. Avoid direct sunlight, heavy dirt, and strong vibrations.

Only operate the device within the ambient conditions specified in the chapter 'Technical specifications' of this user manual. Avoid heavy temperature fluctuations and do not switch the device on immediately after it was exposed to temperature fluctuations (for example after transport at low outside temperatures).

Dust and dirt inside can damage the unit. When operated in harmful ambient conditions (dust, smoke, nicotine, fog, etc.), the unit should be maintained by qualified service personnel at regular intervals to prevent overheating and other malfunction.



**NOTICE!**

**Power supply**

Before connecting the device, ensure that the input voltage (AC outlet) matches the voltage rating of the device and that the AC outlet is protected by a residual current circuit breaker. Failure to do so could result in damage to the device and possibly injure the user.

Unplug the device before electrical storms occur and when it is unused for long periods of time to reduce the risk of electric shock or fire.



**NOTICE!**

**Risk of fire due to incorrect polarity**

Incorrectly inserted batteries may destroy the device or the batteries.

Ensure that proper polarity is observed when inserting batteries.



### **NOTICE!**

#### **Possible damage by leaking batteries**

Leaking batteries can cause permanent damage to the device.

Take batteries out of the device if it is not going to be used for a longer period.



### **NOTICE!**

#### **Possible staining**

The plasticiser contained in the rubber feet of this product may possibly react with the coating of your parquet, linoleum, laminate or PVC floor and after some time cause permanent dark stains.

In case of doubt, do not put the rubber feet directly on the floor, but use felt-pad floor protectors or a carpet.





**NOTICE!**

**Possible damage due to incorrect storage**

Deep discharge can cause batteries to become permanently damaged or lose some of their capacity.

Before prolonged rest periods, charge the batteries to around 50 % of their capacity and then switch the equipment off. Store the equipment at a temperature between 10 °C and 32 °C in as dry an environment as possible. During extended storage periods, charge the batteries to 50 % approximately every three months.



**NOTICE!**

**Possible damage due to moisture**

Moisture entering into open connectors (plugs and couplers) of DMX or power cords can cause short circuits.

Close unused connectors with end caps intended for this purpose ([www.thomann.de](http://www.thomann.de)).

### 3 Features

Special features of the device:

- Six six-colour LEDs (RGBAWUV), each 15 W)
- Battery operated LED bar for outdoor use
- Built-in wireless DMX G5 receiver
- Operable in stand-alone mode or DMX
- Control via DMX, Wireless DMX, with the supplied infrared remote control and via the HD colour display with touch-sensitive buttons on the device
- 36 selectable mixed colours and effects programmes
- Sound control via built-in microphone
- Various mounting options
- Matching wireless DMX transmitter (Item no. 464173) optionally available

For technological reasons, the light output of LEDs decreases over their lifetime. This effect increases with higher operating temperature. You can extend the service life of the illuminants by providing adequate ventilation and operating the LEDs with the lowest possible brightness.

## 4 Installation

Unpack and check carefully there is no transportation damage before using the unit. Keep the equipment packaging. To fully protect the product against vibration, dust and moisture during transportation or storage use the original packaging or your own packaging material suitable for transport or storage, respectively.

### **Information about protection class IP65**

Equipment with protection class IP65 are dust-tight and completely protected against contact (first code number). They are also protected against splash water from any angle (second code digit). That is why this equipment can also be used outdoors. Event technology equipment is generally only designed for temporary use however (event lighting) and not for permanent use outdoors.

The specified protection class does not make a statement about the weather resistance of the equipment (resistance to changing ambient conditions as well as against the effects of sunlight and UV rays).

The seals and screw connections of the equipment must be checked regularly to ensure a fault-free operation. In cases of doubt, consult a specialist workshop in due time.



### **WARNING!**

#### **Risk of injury caused by falling objects**

Make sure that the installation complies with the standards and rules that apply in your country. Always secure the device with a secondary safety attachment, such as a safety cable or a safety chain.



### **NOTICE!**

#### **Risk of overheating**

The distance between light output and the illuminated surface must be more than 1.5 m (19.7in).

Provide sufficient ventilation.

The ambient temperature must always be below 40 °C (104 °F).

**NOTICE!****Use of stands**

When mounting the device onto a stand, ensure that the stand is in a safe and stable position and that the weight of the device does not exceed the maximum permissible load capacity of the stand.

**NOTICE!****Possible data transmission errors**

For error-free operation make use of dedicated DMX cables and do not use ordinary microphone cables.

Never connect the DMX input or output to audio devices such as mixers or amplifiers.

**Mounting options**

You can install the device hanging, standing, or on a tripod. When in use, the device must always be attached to a solid surface or an approved truss. Use the threads provided for mounting.

Always work from a stable platform whenever installing, moving or servicing the unit. In doing so, the area underneath the unit must be cordoned off.

The safety cable must be threaded through the safety eyelet.



*Please note that this device must not be connected to a dimmer.*

### **Infrared sensor for the remote control**

The infrared receiver for the IR remote control signals is located between the LEDs on the front panel of the device. Make sure it's not obstructed.

### Inserting the battery into the remote control

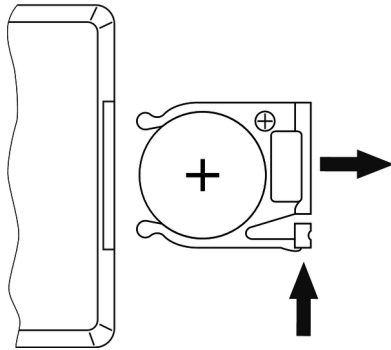

Press the lock of the battery holder to the centre of the housing and pull out the battery holder like a drawer. Insert the battery. The battery is correct if the positive pole points to the housing base of the remote control. Slide the battery holder back into the remote until it clicks into place.

When shipping, the battery is already installed in the remote and protected against discharge by a transparent plastic foil. Remove the plastic foil prior to first use.

## 5 Starting up

Create all connections while the device is off. Use the shortest possible high-quality cables for all connections. Take care when running the cables to prevent tripping hazards.



**Connections in DMX mode**

Connect the DMX input of the device to the DMX output of a DMX controller or another DMX device. Connect the output of the first DMX device to the input of the second one, and so on to form a daisy chain. Always ensure that the output of the last DMX device in the daisy chain is terminated with a resistor ( $110\ \Omega$ ,  $\frac{1}{4}\ \text{W}$ ).

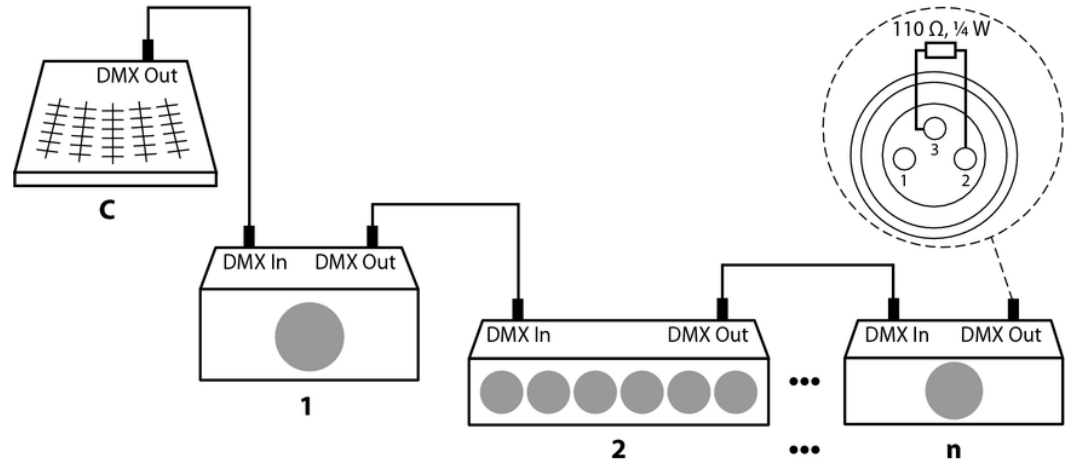

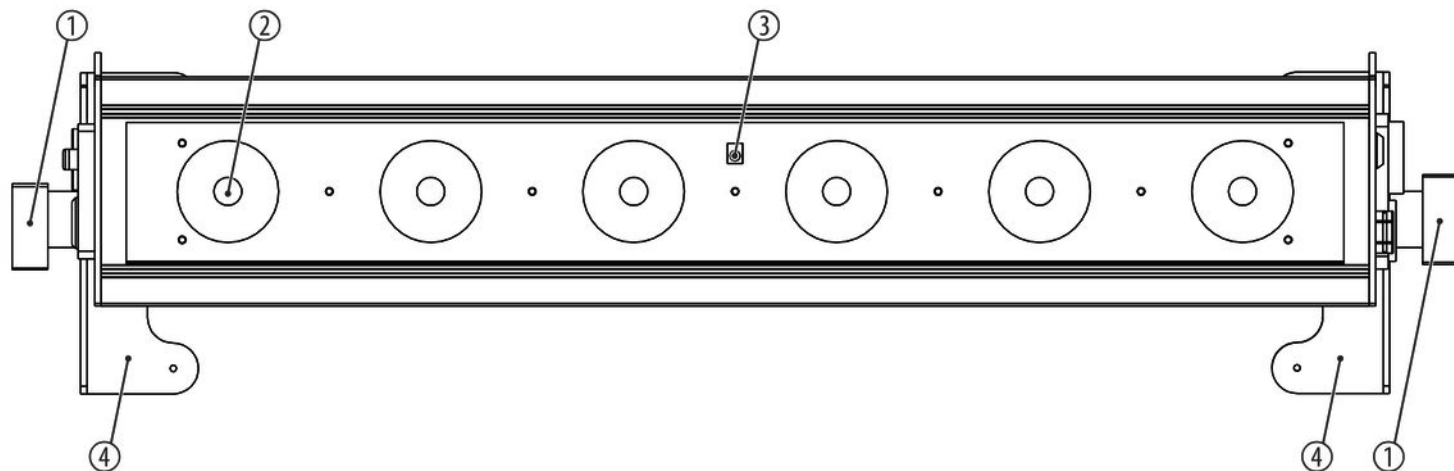

## 6 Connections and controls

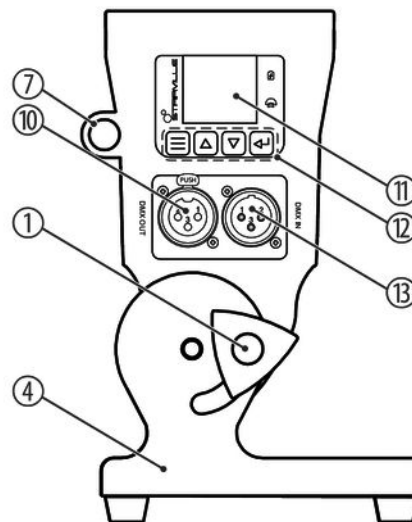
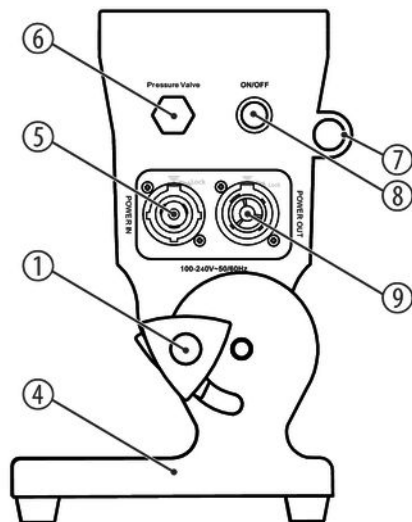

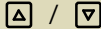

BEL6 IP Bar HEX

1	Locking screw for the mounting bracket
2	LED
3	Infrared sensor for the remote control signals
4	Mounting bracket
5	<i>[POWER IN]</i> Lockable input socket (Seetronic Power Twist TR1) for mains power supply.
6	<i>[PRESSURE VALVE]</i> Pressure compensation valve (prevents condensation inside the device)
7	Safety eyelet for fastening the safety cable
8	<i>[ON / OFF]</i> Main switch. Turns the device on and off
9	<i>[POWER OUT]</i> Lockable output socket (Seetronic Power Twist TR1) for powering a further device.

10	<i>[DMX OUT]</i> DMX output
11	HD colour display
12	Touch-sensitive buttons
	 Activates the main menu and toggles between menu items. Closes an opened submenu
	 Toggles between the menu items of a menu level, increases or decreases the displayed value by one
	 Selects an option of the respective operating mode, confirms the set value
13	<i>[DMX IN]</i> DMX input

Remote control

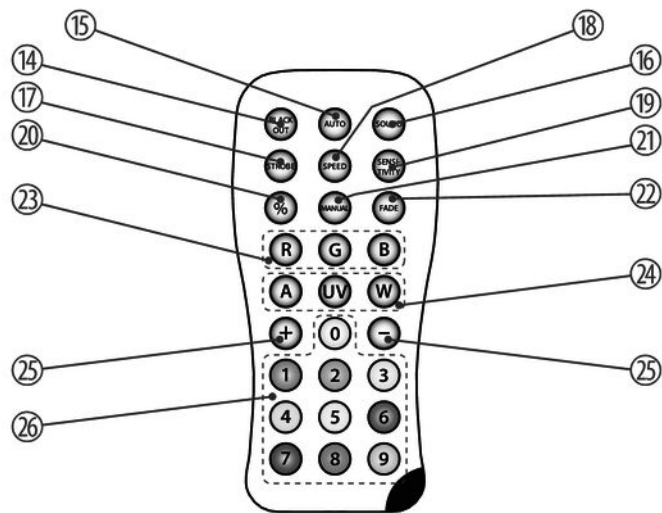

14	<i>[BLACK OUT]</i> Enables or disables blackout.
15	<i>[AUTO]</i> Starts or stops the Auto mode.
16	<i>[SOUND]</i> Starts the music-controlled automatic show.
17	<i>[STROBE]</i> Enables or disables the Strobe effect with the last selected colour.
18	<i>[SPEED]</i> Allows you to set the speed of the automatic programmes with the <i>[+]</i> and <i>[-]</i> buttons.
19	<i>[SENSITIVITY]</i> Allows you to set the sensitivity of the sound control with the <i>[+]</i> and <i>[-]</i> buttons.
20	<i>[%]</i> Resets during the setting of values (speed of the automatic programs, sensitivity of the music control) the displayed value to zero.

21	<i>[MANUAL]</i> Activates the display of a constant colour, which can either be mixed individually with the <i>[R]</i> , <i>[G]</i> and <i>[B]</i> buttons from the basic colours or selected directly with one of the coloured buttons.
22	<i>[FADE]</i> Allows you to choose between the two automatic options by pressing repeatedly.
23	<i>[R]</i> , <i>[G]</i> , <i>[B]</i> Sets the intensity of the three primary colours red, green and blue when a constant colour is displayed.
24	<i>[A]</i> , <i>[UV]</i> , <i>[W]</i> Sets the intensity of the colours amber, white and UV when a constant colour is displayed.
25	<i>[+]</i> , <i>[-]</i> Increases or decreases the set value.
26	Buttons for directly selecting a mixed colour.









## 7 Operating

### 7.1 Starting the device

Connect the device to the power supply to start operation. After a few seconds, the display indicates that a reset is in progress. The device is then ready for use. The display shows the operating mode that was selected when the unit was last powered off.

## 7.2 Main menu

Press  to activate the main menu. Use  or  to select a submenu. When the display shows the desired submenu, press  to open it. To close the main menu, press . The stored values are displayed in white in the display. Changed values are displayed in red until they are confirmed by .

All previously made settings are retained even when you disconnect the device from the power grid. To restart with default values, use the function *'Factory Reset'*.

The following table shows the setting options.

Main menu	Menu level 2	Menu level 3	Menu level 4
Meaning			
'DMX Address'	001...512	Setting the DMX address	
'Mode'	'DMX'	Selecting a DMX mode	
		'6Ch'	6-channel DMX mode

Main menu	Menu level 2	Menu level 3	Menu level 4	
Meaning				
		'10Ch'	10-channel DMX mode	503
	'Auto'	Auto run with fade effect		
		'Fade'	'Sp00' ... 'Sp99'	Fade effect speed
	'Sound'	Sound-controlled auto run		
		'Step'	'Se00' ... 'Se99'	Sensitivity of the built-in microphone
	'Static'	'Dimmer'	0...255	Setting the overall brightness
		'Strobe'	0...255	Stroboscope effect with adjustable speed
		'C-Macro'	1...36	Selection of a mixed colour (see ↻ 'Selectable mixed colours' on page 40)

Main menu	Menu level 2	Menu level 3	Menu level 4	
Meaning				
		'Red'	0...255	Intensity red (0 % to 100 %)
		'Green'	0...255	Intensity green (0 % to 100 %)
		'Blue'	0...255	Intensity blue (0 % to 100 %)
		'White'	0...255	Intensity white (0 % to 100 %)
		'Amber'	0...255	Intensity amber (0 % to 100 %)
		'UV'	0...255	Intensity UV (0 % to 100 %)
	'Slave'	'Slave'	Operating mode 'Slave'	
'Settings'	'W-Dmx'	Wireless DMX control		

Main menu	Menu level 2	Menu level 3	Menu level 4
Meaning			
		'On'	Disabled
		'Off'	Enabled
	'Display'	Automatic display shutdown when not in use	
		'On'	Enabled
		'Off'	Disabled
	'Display Rev'	Display inversion	
		'On'	On, display is rotated by 180°
		'Off'	Off, normal display
	'Limiter'	Lowering the maximum brightness to extend battery life	
		'On'	Enabled
		'Off'	Disabled
	'DMX Fail'	Device behaviour on DMX signal failure	

Main menu	Menu level 2	Menu level 3	Menu level 4
Meaning			
		'Blackout'	Blackout
		'Sound'	Sound-controlled auto run
		'Auto'	Auto run with fade effect
		'Hold'	Retaining last settings
	'Dimmer Curve'	Dimmer curve selection	
		'Linear'	Linear
		'Exp'	Exponential
		'Log'	Logarithmic
		'S Curve'	S-shaped
	'System Info'	'Firmware'	Show firmware version of the device
'Timeinfo'		Operating hours display	
'Temperature'		Show device temperature	

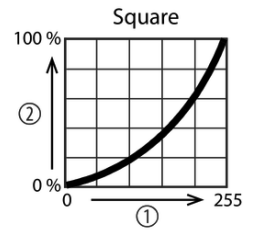
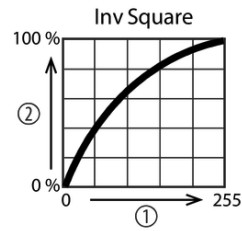
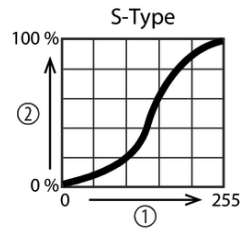
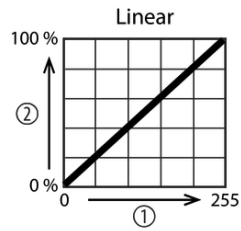

**Selectable mixed colours**

No.	Red	Green	Blue	White	Amber	UV
1	255	0	0	0	0	0
2	0	0	0	0	255	0
3	120	150	0	0	255	0
4	0	255	0	0	0	0
5	0	120	255	0	0	0
6	0	0	255	0	0	0
7	135	0	255	0	0	0
8	255	0	130	0	0	0
9	0	255	0	0	115	0
10	0	0	0	255	0	0
11	255	12	0	0	0	0
12	255	50	0	0	0	0



No.	Red	Green	Blue	White	Amber	UV
13	255	50	0	0	130	0
14	255	50	0	0	255	0
15	255	115	0	0	255	0
16	175	115	0	0	155	0
17	0	54	0	0	255	0
18	0	100	0	0	255	0
19	0	150	0	0	255	0
20	0	255	0	0	255	0
21	0	255	15	0	0	0
22	0	255	40	0	0	0
23	0	255	95	0	0	0
24	0	255	150	0	0	0
25	0	255	255	0	0	0

No.	Red	Green	Blue	White	Amber	UV
26	0	50	255	0	0	0
27	0	0	255	0	135	0
28	0	0	255	0	255	0
29	255	0	255	0	0	0
30	255	0	40	0	0	0
31	0	0	60	255	0	0
32	0	0	130	255	0	0
33	0	0	255	255	0	0
34	0	0	255	130	0	0
35	0	0	0	0	0	255
36	0	0	0	0	0	0

### 7.3 Menu overview

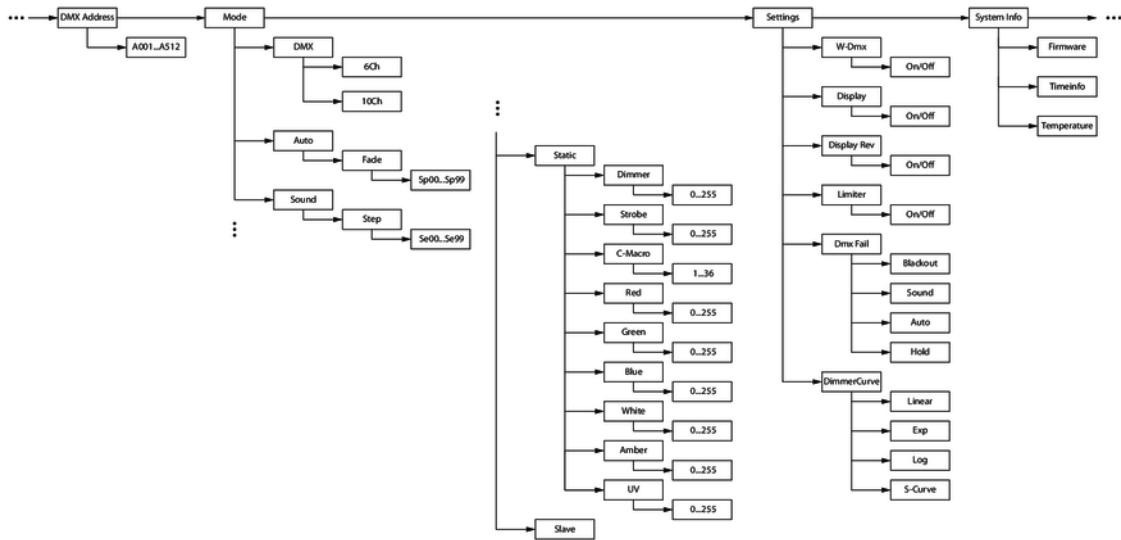

## 7.4 Functions in 6-channel DMX mode

Channel	Value	Function
1	0...255	Intensity red (0 % to 100 %)
2	0...255	Intensity green (0 % to 100 %)
3	0...255	Intensity blue (0 % to 100 %)
4	0...255	Intensity white (0 % to 100 %)
5	0...255	Intensity amber (0 % to 100 %)
6	0...255	Intensity UV (0 % to 100 %)

## 7.5 Functions in 10-channel DMX mode

Channel	Value	Function
1	0...255	Dimmer (0 % to 100 %), if channel 9 = 0...4
2	Strobe effect	
	0	Closed strobe
	1...255	Strobe effect with increasing speed, if channel 9 = 0...4
3	0...255	Intensity red (0 % to 100 %), if channel 9 = 0...4
4	0...255	Intensity green (0 % to 100 %), if channel 9 = 0...4
5	0...255	Intensity blue (0 % to 100 %), if channel 9 = 0...4
6	0...255	Intensity white (0 % to 100 %), if channel 9 = 0...4
7	0...255	Intensity amber (0 % to 100 %), if channel 9 = 0...4
8	0...255	Intensity UV (0 % to 100 %), if channel 9 = 0...4
9	Function selection	

Channel	Value	Function
	0...4	Settings of colour and brightness via channels 1...8
	5...80	Selection of a mixed colour
	81...150	Colour change effect
	151...220	Colour transition effect
	221...255	Automatic sound controlled show
10	0...255	Running speed of automatic show, increasing when channel 9 = 81...220

## 8 Technical specifications

Light source	6 × RGBAWUV LED, each 15 W	
Optical properties	Beam angle	25 °
Control	DMX	
	Wireless DMX	
	Infrared remote control	
Number of DMX channels	6, 10	
Input connections	Voltage supply	Lockable input socket (Seetronic Power Twist TR1)
	DMX control	IP65 Seetronic XLR chassis socket, 3-pin
Output connections	Voltage supply	Lockable output socket (Seetronic Power Twist TR1)
	DMX control	IP65 Seetronic XLR chassis socket, 3-pin

Power consumption	70 W	
Operating supply voltage	110 – 240 V ~ 50/60 Hz	
Battery / rechargeable battery	Battery type	Lithium-ion, chargeable
	Charging time	6 h
	Operating time with fully charged battery and full light output	7 h
Protection class	IP65	
Mounting options	standing, hanging	
	M 10 thread	
Dimensions (W × H × D)	with bracket: 521 mm × 200 mm × 126 mm	
	Bar: 510 mm × 100 mm × 90 mm	
Weight	4.5 kg	
Ambient conditions	Temperature range	0 °C...40 °C
	Relative humidity	50 %, non-condensing



**Further information**

Housing shape	LED bar
LED type	x-in-1
Floor housing	Yes
Fanless	Yes
Incl. remote control	Yes
Housing colour	black

## 9 Plug and connection assignments

### Introduction

This chapter will help you select the right cables and plugs to connect your valuable equipment so that a perfect light experience is guaranteed.

Please take our tips, because especially in 'Sound & Light' caution is indicated: Even if a plug fits into a socket, the result of an incorrect connection may be a destroyed DMX controller, a short circuit or 'just' a not working light show!

### DMX connections



The unit offers a 3-pin XLR socket for DMX output and a 3-pin XLR plug for DMX input. Please refer to the drawing and table below for the pin assignment of a suitable XLR plug.

Pin	Configuration
1	Ground, shielding
2	Signal inverted (DMX-, 'cold signal')
3	Signal (DMX+, 'hot signal')

## 10 Troubleshooting



### **NOTICE!**

#### **Possible data transmission errors**

For error-free operation make use of dedicated DMX cables and do not use ordinary microphone cables.

Never connect the DMX input or output to audio devices such as mixers or amplifiers.

In the following we list a few common problems that may occur during operation. We give you some suggestions for easy troubleshooting:

Symptom	Remedy
The unit does not work, no light	Check the mains connection and the main fuse.
No response to the DMX controller	1. Check the DMX connectors and cables for proper connection.
	2. Check the address settings and the DMX polarity.
	3. Try using another DMX controller.
	4. Check whether the DMX cables run near or parallel to high-voltage cables that may cause damage or interference to a DMX interface circuit.
The built-in battery can no longer be recharged	Do not attempt to replace the built-in battery yourself. Please contact our service centre.

If the procedures recommended above do not succeed, please contact our Service Center. You can find the contact information at [www.thomann.de](http://www.thomann.de).

# 11 Cleaning

## Optical lenses

Clean the optical lenses, that are accessible from the outside, regularly in order to optimize the light output. The frequency of cleaning depends on the operating environment: wet, smoky or particularly dirty surroundings can cause more accumulation of dirt on the optics of the device.

- Clean with a soft cloth using our lamp and lens cleaner (item no. 280122).
- Always dry the parts carefully.

## Fan grids

The fan grids of the device must be cleaned of any contamination, such as dust, etc. on a regular basis. Before cleaning, switch off the device and disconnect mains-operated devices from the mains. Only use pH-neutral, solvent-free and non-abrasive cleaning agents. Clean the unit with a slightly damp lint-free cloth.

## 12 Protecting the environment

### Disposal of the packaging material



For the packaging, environmentally friendly materials have been chosen that can be supplied to normal recycling.

Ensure that plastic bags, packaging, etc. are properly disposed of.

Do not just dispose of these materials with your normal household waste, but make sure that they are collected for recycling. Please follow the notes and markings on the packaging.

### Disposal of batteries



Batteries do contain some hazardous chemicals so they should not be thrown away with the normal household waste. They should be returned to the manufacturer for disposal or recycled elsewhere in accordance with your local regulations.

Remove lithium batteries from the device before disposal. Protect used lithium batteries against potential short circuits, e.g. by covering the poles with adhesive tape. Dispose the built-in lithium batteries together with the device. Please check for an appropriate reception facility.

### Disposal of your old device



This product is subject to the European Waste Electrical and Electronic Equipment Directive (WEEE) in its currently valid version. Do not dispose with your normal household waste.

Dispose of this device through an approved waste disposal firm or through your local waste facility. When discarding the device, comply with the rules and regulations that apply in your country. If in doubt, consult your local waste disposal facility.





BEL6 IP Bar HEX





