



LB-3

lighting stand

Musikhaus Thomann  
Thomann GmbH  
Hans-Thomann-Straße 1  
96138 Burgebrach  
Germany  
Telephone: +49 (0) 9546 9223-0  
E-mail: [info@thomann.de](mailto:info@thomann.de)  
Internet: [www.thomann.de](http://www.thomann.de)

11.03.2020, ID: 485708

---

# Table of contents

|          |   |           |
|----------|---|-----------|
| <b>1</b> | <b>General information</b> .....        | <b>4</b>  |
|          | 1.1 Further information.....            | 5         |
|          | 1.2 Notational conventions.....         | 6         |
|          | 1.3 Symbols and signal words.....       | 6         |
| <b>2</b> | <b>Safety instructions</b> .....        | <b>8</b>  |
| <b>3</b> | <b>Features</b> .....                   | <b>11</b> |
| <b>4</b> | <b>Installation</b> .....               | <b>12</b> |
| <b>5</b> | <b>Technical specifications</b> .....   | <b>20</b> |
| <b>6</b> | <b>Protecting the environment</b> ..... | <b>22</b> |

# 1 General information

This manual contains important instructions for the safe operation of the product. Read and follow the safety instructions and all other instructions. Keep the manual for future reference. Make sure that it is available to all those using the product. If you sell the unit, please make sure that the buyer also receives this manual.

Our products and user manuals are subject to a process of continuous development. We therefore reserve the right to make changes without notice. Please refer to the latest version of the user manual which is ready for download under [www.thomann.de](http://www.thomann.de).

## 1.1 Further information

On our website ([www.thomann.de](http://www.thomann.de)) you will find lots of further information and details on the following points:

|                       |   |
|-----------------------|---|
| Download              | This manual is also available as PDF file for you to download.                                    |
| Keyword search        | Use the search function in the electronic version to find the topics of interest for you quickly. |
| Online guides         | Our online guides provide detailed information on technical basics and terms.                     |
| Personal consultation | For personal consultation please contact our technical hotline.                                   |
| Service               | If you have any problems with the device the customer service will gladly assist you.             |



## 1.2 Notational conventions

This manual uses the following notational conventions:

### Instructions

The individual steps of an instruction are numbered consecutively. The result of a step is indented and highlighted by an arrow.

#### Example:

1.  Switch on the device.
2.  Press *[Auto]*.
  - ⇒ Automatic operation is started.
3.  Switch off the device.

## 1.3 Symbols and signal words

In this section you will find an overview of the meaning of symbols and signal words that are used in this manual.

| Signal word   | Meaning  |
|---|--|
| <b>DANGER!</b>  | This combination of symbol and signal word indicates an immediate dangerous situation that will result in death or serious injury if it is not avoided.        |
| <b>WARNING!</b>   | This combination of symbol and signal word indicates a possible dangerous situation that can result in death or serious injury if it is not avoided.           |
| <b>CAUTION!</b>   | This combination of symbol and signal word indicates a possible dangerous situation that can result in minor injury if it is not avoided.                      |
| <b>NOTICE!</b>  | This combination of symbol and signal word indicates a possible dangerous situation that can result in material and environmental damage if it is not avoided. |
| Warning signs   | Type of danger   |
|  | Warning – danger zone.   |

## 2 Safety instructions

### **Intended use**

This light stand is intended to be used for the stable mounting and height-adjustable positioning of spotlights. Use the device only as described in this user manual. Any other use or use under other operating conditions is considered to be improper and may result in personal injury or property damage. No liability will be assumed for damages resulting from improper use.

This device may be used only by persons with sufficient physical, sensorial, and intellectual abilities and having corresponding knowledge and experience. Other persons may use this device only if they are supervised or instructed by a person who is responsible for their safety.



**Safety**



**DANGER!**

**Danger for children**

Ensure that plastic bags, packaging, etc. are properly disposed of and are not in the reach of babies and young children. Choking hazard!

Ensure that children do not detach any small parts (e.g. knobs or the like) from the product. They could swallow the pieces and choke!

Never let children play unattended with the product.



**CAUTION!**

**Danger of tipping when transported under load**

If the stand is moved without having removed the installed device, the stand may tip over and cause injuries and property damage.

Remove the installed device before transporting the stand.



**CAUTION!**

**Danger of tipping on unsuitable surfaces**

When the speaker stand is installed on soft or uneven ground, the stand may tip over and cause injuries and property damage.

Install the stand only on even and solid surfaces.



**CAUTION!**

**Danger of tipping due to overload**

In case of overload, the stand may tip over and cause injuries and property damage.

Never exceed the maximum load capacity specified for the stand.

### 3 Features

- Complete lighting stand set consisting of
  - two truss beams
  - two lighting stands
  - two truss holder
- suitable for mounting of up to eight spot lights or effects
- Extension tubes secured by safety bolts
- Truss tube diameter: 18 mm
- Stand tube diameter: 28 mm
- maximum load capacity: 60 kg
- maximum height: 3.18 m
- Width: 3.91 m

## 4 Installation

Unpack and check carefully there is no transportation damage before using the product. Keep the equipment packaging. To fully protect the product against vibration, dust and moisture during transportation or storage use the original packaging or your own packaging material suitable for transport or storage, respectively.



### **CAUTION!**

#### **Danger of tipping when transported under load**

If the stand is moved without having removed the installed device, the stand may tip over and cause injuries and property damage.

Remove the installed device before transporting the stand.



**CAUTION!**

**Danger of tipping on unsuitable surfaces**

When the speaker stand is installed on soft or uneven ground, the stand may tip over and cause injuries and property damage.

Install the stand only on even and solid surfaces.



**CAUTION!**

**Danger of tipping due to overload**

In case of overload, the stand may tip over and cause injuries and property damage.

Never exceed the maximum load capacity specified for the stand.



### **WARNING!**

#### **Risk of falling when mounting the truss or the spotlight**

When falling off an unsuitable climbing assistance, you could be injured or be caught by falling objects.

Use a suitable working platform or a sturdy ladder for mounting a truss or a spotlight.

Place the working platform or the ladder on a flat and stable ground.



### **NOTICE!**

#### **Possible staining**

The plasticiser contained in the rubber feet of this product may possibly react with the coating of your parquet, linoleum, laminate or PVC floor and after some time cause permanent dark stains.

In case of doubt, do not put the rubber feet directly on the floor, but use felt-pad floor protectors or a carpet.



***Comply with regulations***

*When installing and operating, make sure to follow the standards and regulations that apply in your country.*

## Mounting

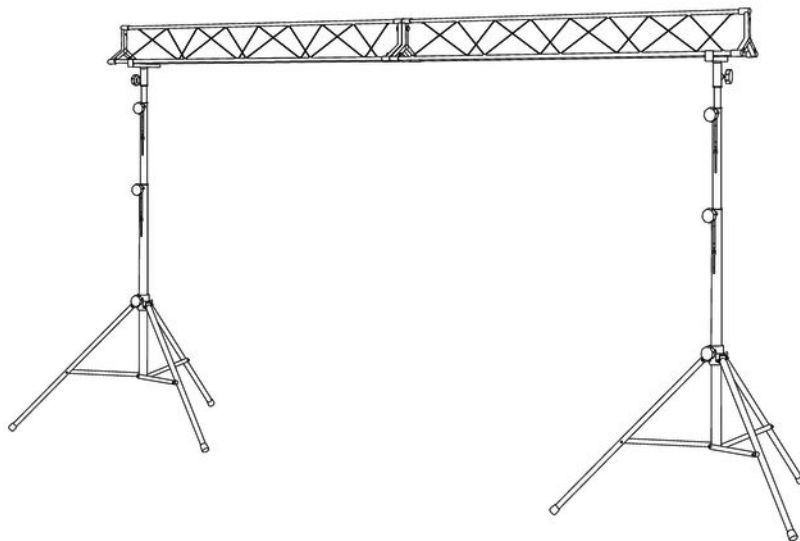



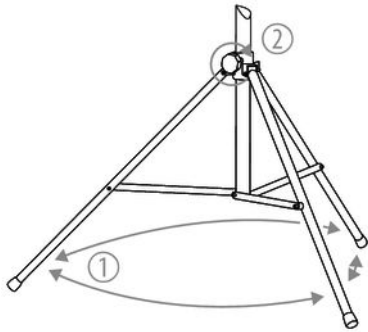

1. ➤ Unfold the feet of the stands until the cross braces are in a horizontal position.
2. ➤ Fix this position with the safety screw on the slider to which the three feet are attached.

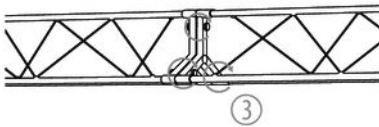

3. ➤ Screw the two truss parts with the three supplied hex screws and nuts.



- 4.** ▶ Insert the two truss holders into the extension tubes of the two tripods and fix the adapter with the mounting screw.

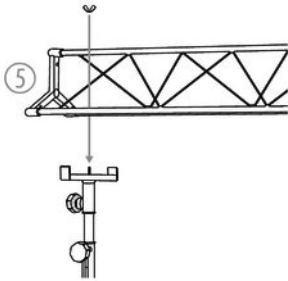

- 5.** ▶ Attach the mounted truss beam and fix it in the desired position with the wing nuts.

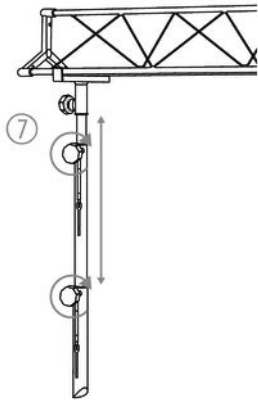

- 6.** ▶ Loosen the two screws on the extension tubes. Pull out the extension tubes of the two stands to the desired height and fix both with the help of the locking screw on the stand.
  
- 7.** ▶ Mount up to eight effects or spot lights to the truss beam. Arrange the devices as balanced as possible. Observe the instructions of the respective manufacturers. The maximum load capacity of 60 kg in total must not be exceeded.
  
- 8.** ▶ To dismantle the set proceed in the reverse order.

## 5 Technical specifications

|                                       |                           |
|---------------------------------------|---------------------------|
| Height, max.                          | 3.18 m                    |
| Total width                           | 3.91 m                    |
| Adjustable stand height               | 2.12 m ... 3.18 m         |
| Footprint per stand                   | Ø 1.21 m                  |
| Single truss length                   | 1.50 m                    |
| Truss tube diameter                   | Ø 18 mm                   |
| Stand tube diameter                   | Ø 28 mm                   |
| Mounting slots                        | 8                         |
| Mounting options                      | 2 × truss flange          |
| Max. load capacity (for centric load) | 60 kg                     |
| Transport dimensions (W × H × D)      | 207 mm × 1500 mm × 182 mm |

|        |         |
|--------|---------|
| Weight | 22.5 kg |
| Colour | Black   |

**Further information**

|                  |                 |
|------------------|-----------------|
| Stand type       | Back ground kit |
| Incl. truss beam | Yes             |
| Crank            | No              |

## 6 Protecting the environment

### Disposal of the packaging material



For the transport and protective packaging, environmentally friendly materials have been chosen that can be supplied to normal recycling.

Ensure that plastic bags, packaging, etc. are properly disposed of.

Do not just dispose of these materials with your normal household waste, but make sure that they are collected for recycling. Please follow the notes and markings on the packaging.



