

th•mann

DP-28 Plus, DP-28 Plus WH

User Manual

Digital Piano

Thomann GmbH
Hans-Thomann-Straße 1
96138 Burgebrach
Germany
Telephone: +49 (0) 9546 9223-0
Internet: www.thomann.de

21.12.2023, ID: 493572, 520276 (V3)

Table of contents

1	General information	6
	1.1 Symbols and signal words.....	6
2	Safety instructions	7
3	Features	8
4	Assembly instructions	9
5	Control panel and connections	10
6	Connection options	12
7	Switching on / off and basic operation	14
	7.1 Switching on the digital piano.....	14
	7.1.1 Switching on / off normally.....	14
	7.1.2 Automatic shutoff.....	14
	7.2 Adjusting the volume.....	14
	7.3 Setting the tone colour.....	14
	7.4 D.A.S (Dynamic Acoustic System).....	15
	7.5 Touch velocity.....	15
	7.6 Transposing.....	15
	7.7 Tuning.....	16
	7.8 Temperament.....	16
	7.9 Selecting sounds.....	17
	7.10 Layer mode and split point.....	18
	7.10.1 Setting the Layer mode.....	18
	7.10.2 Split point setting.....	19
	7.11 Metronome.....	20
	7.12 Local ON/OFF.....	21
	7.13 Demo tracks.....	22
	7.14 Tempo.....	23
	7.15 Digital effects.....	23
	7.15.1 Reverb and chorus.....	23
	7.16 TWINOVA.....	24
	7.17 Recording function.....	24
	7.17.1 Recording preparation.....	24
	7.17.2 Recording.....	24
	7.17.3 Stopping recording.....	24
	7.17.4 Playing a recording.....	25
	7.18 Further setting options.....	25
	7.18.1 String resonance.....	25
	7.18.2 Damper resonance.....	25
	7.18.3 Damper noise.....	26
	7.18.4 Hammer noise.....	26
	7.18.5 LID simulation.....	27
	7.19 MIDI functions.....	27
	7.19.1 What is MIDI?.....	27
	7.19.2 USB connection.....	27
	7.19.3 MIDI connection.....	28
	7.19.4 Bluetooth® MIDI connection.....	28
	7.20 Operating tone.....	28

	7.21 Factory defaults.....	29
8	Sound list.....	30
9	Practise and demo tracks.....	31
10	Metronome rhythm list.....	33
11	MIDI implementation chart.....	34
12	Troubleshooting.....	36
13	Technical specifications.....	37
14	Plug and connection assignment.....	38
15	Protecting the environment.....	39



1 General information

This document contains important instructions for the safe operation of the product. Read and follow the safety instructions and all other instructions. Keep the document for future reference. Make sure that it is available to all those using the product. If you sell the product to another user, be sure that they also receive this document.

Our products and documentation are subject to a process of continuous development. They are therefore subject to change. Please refer to the latest version of the documentation, which is ready for download under www.thomann.de.

1.1 Symbols and signal words

In this section you will find an overview of the meaning of symbols and signal words that are used in this document.

Signal word	Meaning
DANGER!	This combination of symbol and signal word indicates an immediate dangerous situation that will result in death or serious injury if it is not avoided.
WARNING!	This combination of symbol and signal word indicates a possible dangerous situation that can result in death or serious injury if it is not avoided.
NOTICE!	This combination of symbol and signal word indicates a possible dangerous situation that can result in material and environmental damage if it is not avoided.
Warning signs	Type of danger
	Warning – danger zone.

2 Safety instructions

Intended use

This device is intended to be used for electronic sound generation using a piano keyboard. Use the device only as described in this user manual. Any other use or use under other operating conditions is considered to be improper and may result in personal injury or property damage. No liability will be assumed for damages resulting from improper use.

This device may be used only by persons with sufficient physical, sensorial, and intellectual abilities and having corresponding knowledge and experience. Other persons may use this device only if they are supervised or instructed by a person who is responsible for their safety.

Safety



DANGER!

Risk of injury and choking hazard for children!

Children can suffocate on packaging material and small parts. Children can injure themselves when handling the device. Never allow children to play with the packaging material and the device. Always store packaging material out of the reach of babies and small children. Always dispose of packaging material properly when it is not in use. Never allow children to use the device without supervision. Keep small parts away from children and make sure that the device does not shed any small parts (such knobs) that children could play with.



WARNING!

Possible hearing damage due to high volumes on speakers or headphones!

With speakers or headphones connected, the device can produce volume levels that may cause temporary or permanent hearing impairment. Over an extended period of time, even levels that seem to be uncritical can cause hearing damage. Do not operate the device permanently at a high volume level. Decrease the volume level immediately if you experience ringing in your ears or hearing impairment.



NOTICE!

Damage to the device if operated in unsuitable ambient conditions!

The device can be damaged if it is operated in unsuitable ambient conditions. Only operate the device indoors within the ambient conditions specified in the "Technical specifications" chapter of this user manual. Avoid operating it in environments with direct sunlight, heavy dirt and strong vibrations. Avoid operating it in environments with strong temperature fluctuations. If temperature fluctuations cannot be avoided (for example after transport in low outside temperatures), do not switch on the device immediately. Never subject the device to liquids or moisture. Never move the device to another location while it is in operation. In environments with increased dirt levels (for example due to dust, smoke, nicotine or mist): Have the device cleaned by qualified specialists at regular intervals to prevent damage due to overheating and other malfunctions.



NOTICE!

Damage to the external power supply due to high voltages!

The device is powered by an external power supply. The external power supply can be damaged if it is operated with the incorrect voltage or if high voltage peaks occur. In the worst case, excess voltages can also cause a risk of injury and fires. Make sure that the voltage specification on the external power supply matches the local power grid before plugging in the power supply. Only operate the external power supply from professionally installed mains sockets that are protected by a residual current circuit breaker (FI). As a precaution, disconnect the power supply from the power grid when storms are approaching or it the device will not be used for a longer period.



NOTICE!

Possible staining due to plasticiser in rubber feet!

The plasticiser contained in the rubber feet of this product may react with the coating of the floor and cause permanent dark stains after some time. If necessary, use a suitable mat or felt slide to prevent direct contact between the device's rubber feet and the floor.

3 Features

The digital piano is characterized by the following features:

- 88 weighted keys with hammer action
- 25 sounds
- Metronome with 50 rhythms
- 192-voice polyphony
- Layer and Split mode
- TWINOVA (duo mode)
- 100 practice and accompaniment songs
- D.A.S, Reverb and Chorus effects
- Transpose function
- Automatic shutoff, deactivatable
- Built-in speakers
- Bluetooth®-MIDI, e.g. for instrument management via app (e.g. **PianoToolBox**)
- Connections: 2 × headphone output, MIDI out, USB-MIDI, sustain pedal, Aux IN, Line OUT
- 12 V power supply included
- Music rest included
- Sustain pedal included
- Operating system: Windows® 8 and later, Mac OS X® 10.8 and later

4 Assembly instructions

Unpack and check carefully there is no transportation damage before using the unit. Keep the equipment packaging. To fully protect the product against vibration, dust and moisture during transportation or storage use the original packaging or your own packaging material suitable for transport or storage, respectively.

Set up the device in the desired location.

Voltage supply



The unit is powered by the included 12 V power supply. Make sure that the device is turned off before you connect it to the power supply or disconnect it.

Turn the volume knob counter-clockwise to minimum before connecting the digital piano to the power supply or to other devices. This is to protect the speakers from damage.

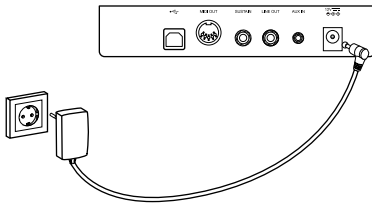

Connect the cable from the power supply outlet to the input socket [12V] on the rear panel of the piano. Plug the plug of the power cord into a properly wired and earthed mains wall outlet.

5 Control panel and connections

Overview

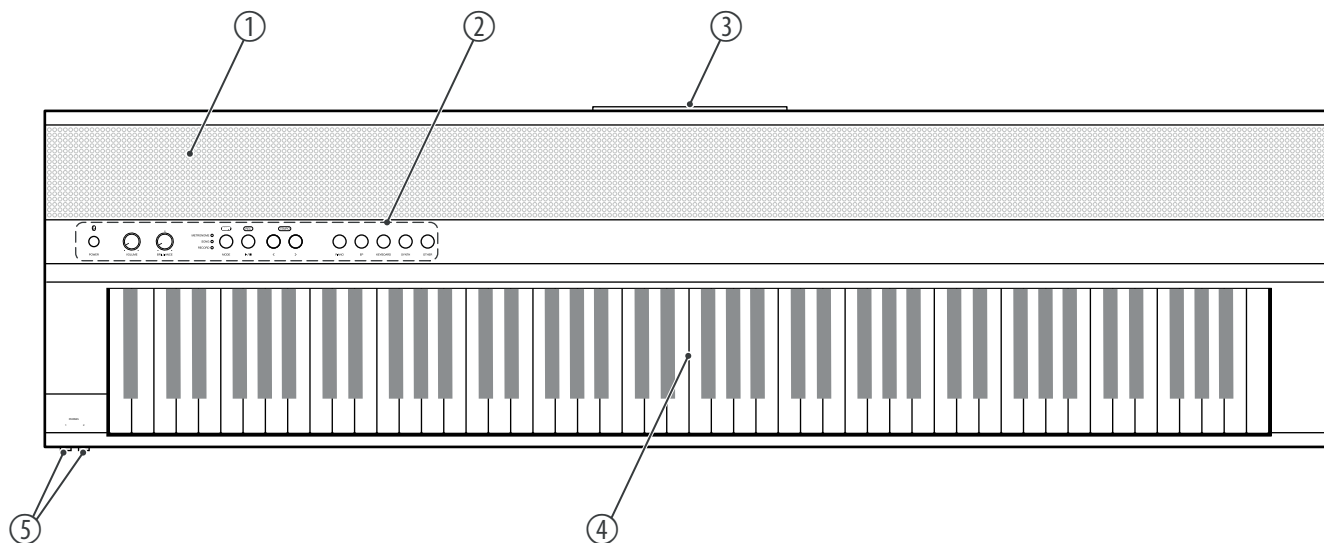

1	Built-in speakers
2	Control panel with function keys and rotary knobs.
3	-Connections on the back
4	Keyboard with 88 keys (the additional functions of the keys can be found in the attached overview)
5	2 × connection sockets for headphones

Control panel

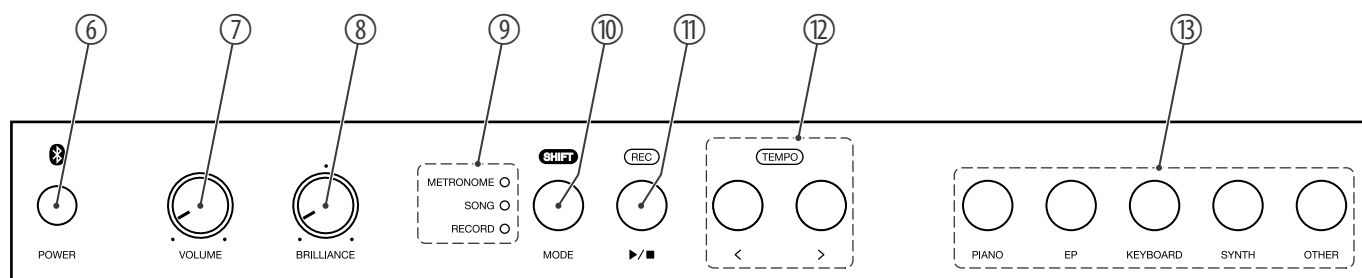

6	[POWER] Button to turn the digital piano on and off
7	[VOLUME] Rotary control to adjust the overall volume
8	[BRILLIANCE] Rotary control to adjust the tone colour
9	LEDs to indicate the activated mode ([METRONOME], [SONG], [RECORD])
10	[MODE] Mode selection button (first function) [SHIFT] Enables the second button function in combination with one of the buttons [11] and [12].
11	▶/■ Button to play or stop the practice and demo tracks (first function) [REC] Button to activate recording mode (second function)

- | | |
|----|---|
| 12 | [<] / [>] Buttons for setting the parameters and selecting the functions
[TEMPO] Buttons for setting the tempo during playback (second function) |
| 13 | [PIANO] / [EP] / [KEYBOARD] / [SYNTH] / [OTHER] Buttons for selecting a sound |

-Connections on the back

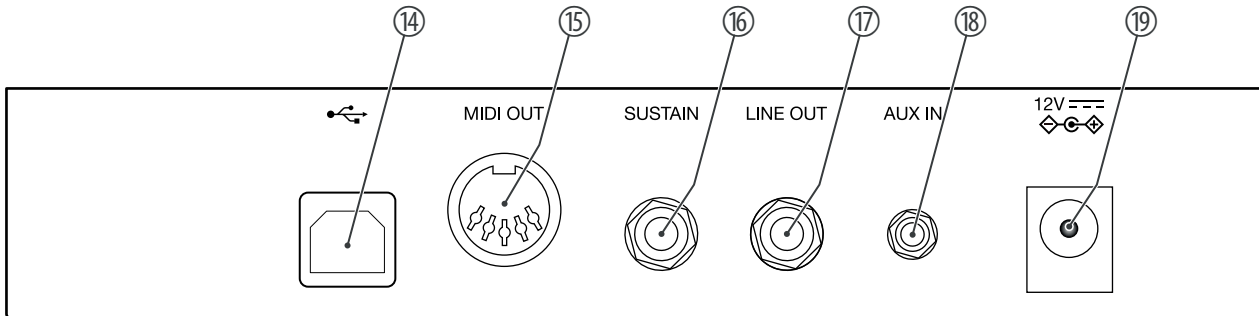

- | | |
|----|---|
| 14 | 🔌 USB-to-host interface for connection to a computer (MIDI data) |
| 15 | [MIDI OUT] MIDI out for connecting an external MIDI device |
| 16 | [SUSTAIN] Sustain pedal connection (6.35 mm (1/4") jack socket) |
| 17 | [LINE OUT] Stereo output socket for connection to external audio equipment, e.g. a stereo system (6.35 mm (1/4") jack socket) |
| 18 | [AUX IN] Stereo input socket for connecting an external audio device (e.g. MP3 or CD player, 3.5 mm jack socket). |
| 19 | [12 V] Connection for the external power supply |

6 Connection options

Headphones

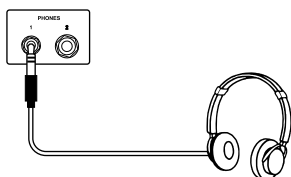

To the left beneath the keyboard you will find headphones outlets 1 and 2. Connecting headphones (not supplied) to the outputs mutes the speakers.

External audio devices via LINE OUT

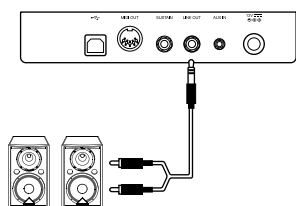

Use the [LINE OUT] socket to connect the digital piano to an amplifier, stereo device, mixing console or recording device. Plug one end of the audio cable into the [LINE OUT] socket on the rear panel of the digital piano and the other end into the input of the respective audio device.



NOTICE!

To prevent damage to the speakers, turn the volume down to “Minimum” before you connect other devices to the digital piano.

External audio devices via AUX IN

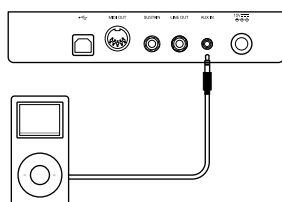

Use the [AUX IN] socket to connect e.g. a CD or MP3 player to the digital piano. This enables you to playback music through the internal speakers of the digital piano and simultaneously play along to it. Plug one end of the audio cable into the [AUX IN] socket on the rear panel of the digital piano and the other end into the output of the respective audio device.

Computer via USB-MIDI

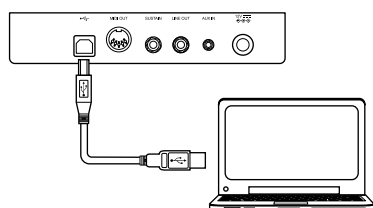

You can connect the digital piano to a PC for data exchange via the USB-to-host interface. You can also connect the digital piano to smartphones, tablets or other mobile devices and control it using a suitable app (e.g. **PianoToolBox**).



Use an up-to-date operating system still supported by the provider to avoid technical difficulties.

MIDI device via MIDI OUT

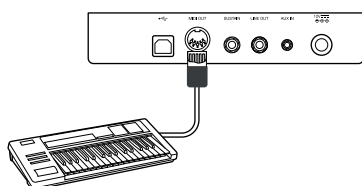

Use the MIDI interface to send MIDI data to an external MIDI device.

Sustain pedal

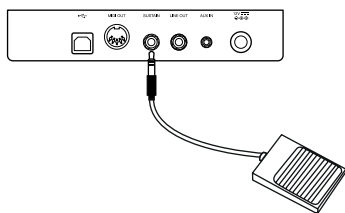

Use the [*SUSTAIN*] connection socket to connect a sustain pedal to the digital piano.

Pedal box

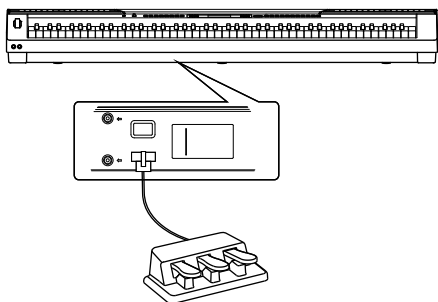

You can connect a triple-pedal (Sustain, Sostenuto and Soft) from the optional Thomann original stand (item no. 352262) via the connection socket on the bottom of the digital piano.

7 Switching on / off and basic operation

7.1 Switching on the digital piano

7.1.1 Switching on / off normally

1. ➤ Press **[POWER]** to turn the digital piano on.
⇒ The LEDs of the digital piano light up. The digital piano is operational.
2. ➤ Press and hold **[POWER]** to turn the digital piano off.
⇒ The LEDs of the digital piano go out.

7.1.2 Automatic shutoff

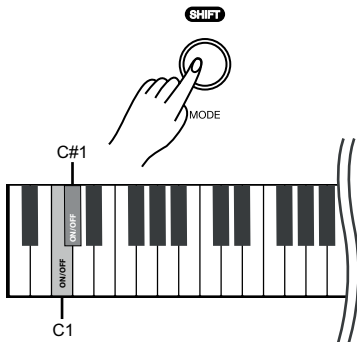

If the digital piano is not used for 30 minutes, it switches off automatically in order to avoid unnecessary power consumption. Automatic shutoff is enabled by default.

1. ➤ Press **[POWER]** to turn the digital piano on.
⇒ The LEDs of the digital piano light up. The digital piano is operational.
2. ➤ Press and hold **[SHIFT]** and then simultaneously press the piano keys **[C1]** and **[C#1]** to deactivate automatic shutoff.
3. ➤ To reactivate automatic shutoff, press and hold **[SHIFT]** and then simultaneously press the piano keys **[C1]** and **[C#1]**.

7.2 Adjusting the volume



Adjust the **[VOLUME]** control for a pleasant volume for playback and practising.

1. ➤ Turn the **[VOLUME]** control clockwise to increase the volume.
2. ➤ Turn the **[VOLUME]** control anti-clockwise to decrease the volume.

7.3 Setting the tone colour



Use the **[BRILLIANCE]** control to set the tone colour of the digital piano.

1. ➤ Turn the **[BRILLIANCE]** control clockwise to adjust the treble for the entire keyboard.
2. ➤ Turn the **[BRILLIANCE]** control anti-clockwise to adjust the bass for the entire keyboard.

7.4 D.A.S (Dynamic Acoustic System)

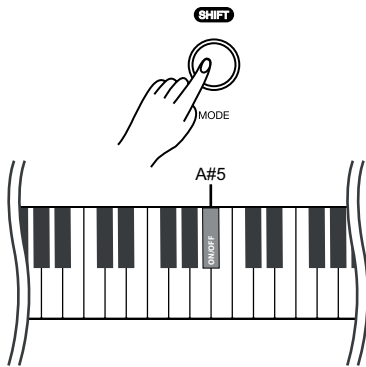

Activate the D.A.S to automatically increase the bass and treble in conjunction with the master volume even at low volume.

1. ➤ Hold down *[SHIFT]* and press the piano key *[A#5]*.
2. ➤ To deactivate the D.A.S (Dynamic Acoustic System) again, hold down *[SHIFT]* and press the piano key *[A#5]* again.

7.5 Touch velocity

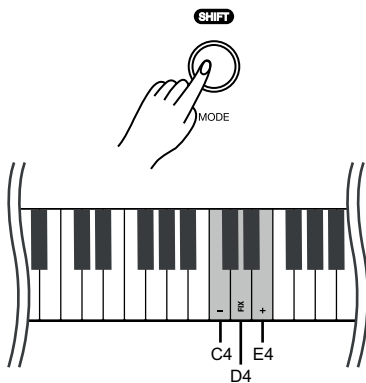

With this function you can adjust the touch velocity of the keyboard in six different levels.

1. ➤ Hold down *[SHIFT]* and use the piano keys *[C4]* and *[E4]* to adjust the touch velocity. Each keystroke alters the parameter by 1.

Parameter	Meaning
[1]	Piano
[2]	Mezzo Piano
[3]	Standard
[4]	Mezzo Forte
[5]	Forte

2. ➤ Press and hold *[SHIFT]* and press the piano key *[D4]* to deactivate touch velocity.

7.6 Transposing

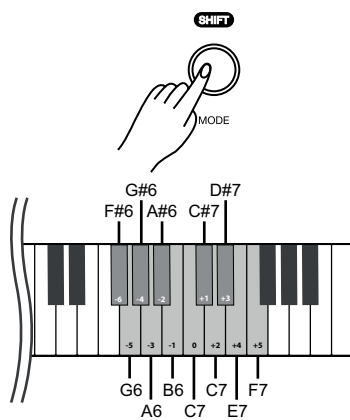

With this function you can adjust the pitch of the keyboard in semitone steps (12 at max.) up or down.

- Press and hold *[SHIFT]* and press the piano keys *[F#6]* ... *[F7]* to adjust the pitch of the keyboard up or down in 12 semitones.

7.7 Tuning

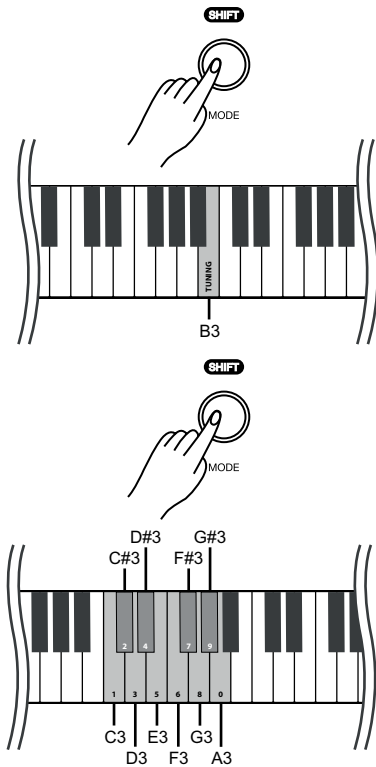

With this function you can fine tune the pitch of the entire keyboard.

1. ➤ Press and hold *[SHIFT]* and press the piano key *[B3]* to activate the tuning function.
2. ➤ Press and hold *[SHIFT]* and use the piano keys *[C3]...[A3]* to adjust the tuning in a range of a semitone (= 100 cent). To do this, enter a four-digit value.



- If you want to change the tuning with the piano keys *[C3]* to *[A3]*, always enter it in four-digit format. For example, to set the frequency to '452.3 Hz', hold down *[SHIFT]* and press the piano keys *[D#3]*, *[E3]*, *[C#3]* and *[D3]* in succession.
- To restore the standard pitch (= 440.0 Hz), hold down *[SHIFT]* and press the piano keys *[D#3]*, *[D#3]*, *[A3]* and *[A3]* in succession.

3. ➤ Release *[SHIFT]* to confirm the adjustment.

7.8 Temperament

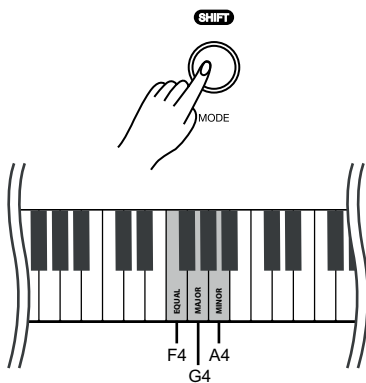

The digital piano has a total of three temperament settings that can be set using the piano keys.

- ➔ Hold down *[SHIFT]* and press one of the piano keys *[F4]*, *[G4]* or *[A4]* to set the desired temperature. By default, the temperament is set to 'EQUAL'.

Piano key	Meaning
[F4]	<p>EQUAL</p> <p>The equal tempered tuning divides the octave into 12 equal semitone steps. This tuning has become standard over time because playing all keys is equally possible.</p>
[G4]	<p>JUST MAJOR</p> <p>A tuning process in which the intervals are tuned without beat. This creates chords with great sonority. For physical reasons, this only works for the major key specified here.</p> <p>Related chords have low beats, distant chords (such as F sharp major in a pure C tuning) usually sound very out of tune.</p>
[A4]	<p>JUST MINOR</p> <p>A tuning process in which the intervals are tuned without beat. This creates chords with great sonority. For physical reasons, this only works for the minor key specified here.</p> <p>Related chords have low beats, distant chords (such as F sharp minor in a pure C tuning) usually sound very out of tune.</p>



Many of the functions can be easily controlled from a mobile device using suitable apps (e.g. **PianoToolBox**), which can be downloaded from the App Store® or Google Play.

7.9 Selecting sounds

The digital piano has a total of 25 sounds that can be called up using the [PIANO] / [EP] / [KEYBOARD] / [SYNTH] / [OTHER] buttons (see [Chapter 8 'Sound list'](#) on page 30).

1. ➤ Press one of the [PIANO] / [EP] / [KEYBOARD] / [SYNTH] / [OTHER] buttons to select a sound group.
 - ⇒ The LED of the selected button lights up.
2. ➤ Press the key of the selected sound group repeatedly to determine a desired variation sound in it (see [Chapter 8 'Sound list'](#) on page 30).
3. ➤ To select a different sound group, press one of the [PIANO] / [EP] / [KEYBOARD] / [SYNTH] / [OTHER] buttons again.

7.10 Layer mode and split point

7.10.1 Setting the Layer mode

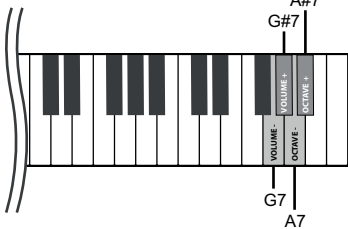
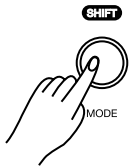
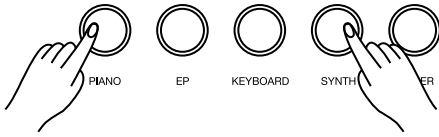

With the layer mode you can set the "layering" of sounds.

1. Hold down one of the *[PIANO]* / *[EP]* / *[KEYBOARD]* / *[SYNTH]* / *[OTHER]* buttons and then press another one for the layer (e.g. *[PIANO]* and *[SYNTH]*) to activate the layer mode.
⇒ The LEDs of the selected buttons light up.
2. Press the selected keys (e.g. *[PIANO]* and *[SYNTH]*) repeatedly to set a desired variation sound for the selected sound groups (see ↪ Chapter 8 'Sound list' on page 30).
3. Hold down *[SHIFT]* and press the piano keys *[A7]* or *[A#7]* to set the octave shift for the layer tone (SOUND R2).
4. Hold down *[SHIFT]* and press the piano keys *[G7]* or *[G#7]* to set the volume for the layer tone (SOUND R2).
5. To deactivate the layer mode, hold down the button whose sound you want to switch off (e.g. *[SYNTH]*) until the LED goes out.
⇒ Layer mode is deactivated.
6. To reactivate layer mode, proceed as described in step 1.

7.10.2 Split point setting

This feature allows you to select a point that splits the entire keyboard into two sections and to assign different voices to those sections. The preset split point is on piano key [F#3].

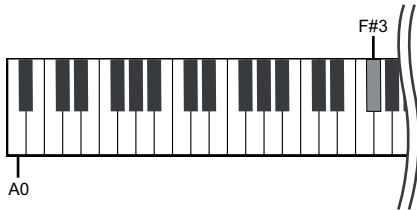

1. Hold down two of the [PIANO] / [EP] / [KEYBOARD] / [SYNTH] / [OTHER] buttons and press the desired piano key to which you want to assign the split point.



If you press several piano keys when assigning the split point, the last key you pressed will be set as the split point.

2. Release both buttons.
 - ⇒ The LEDs of the selected buttons light up. The new setting is instantly applied.
3. Press the selected keys (e.g. [PIANO] and [SYNTH]) repeatedly to set a desired variation sound for the selected sound groups (see Chapter 8 'Sound list' on page 30).
4. Hold down [SHIFT] and press the piano keys [A7] or [A#7] to set the octave shift for the second voice (SOUND L).
5. Hold down [SHIFT] and press the piano keys [G7] or [G#7] to set the volume for the second voice (SOUND L).
6. To disable split mode, press and hold the buttons you've selected in step 1.
 - ⇒ The LEDs of the selected buttons turn off. Split mode is deactivated.

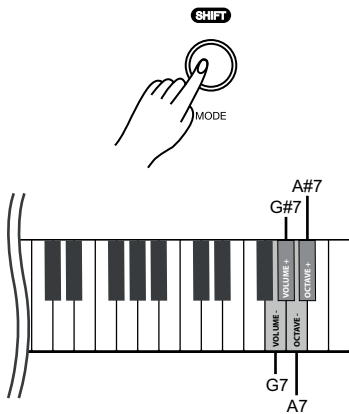

*Many of the functions can be easily controlled from a mobile device using suitable apps (e.g. **PianoToolBox**), which can be downloaded from the App Store® or Google Play.*

7.11 Metronome

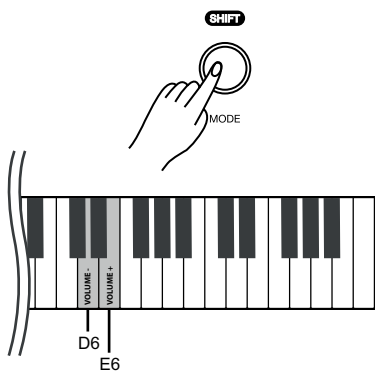
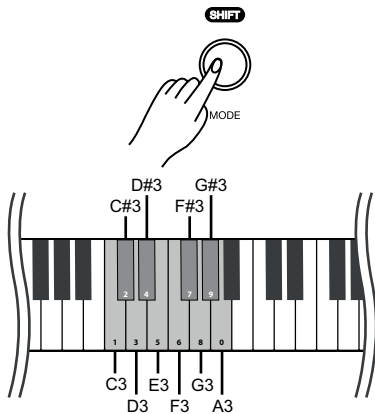

1. Switching on metronome

To turn on the metronome, press *[MODE]* repeatedly until the *[METRONOME]* LED lights up.

2. Press ▶/■ to start playing with the metronome.

⇒ The LED of the ▶/■ button flashes.

3. Setting the time signature

Press *[<]* or *[>]* to set the desired time signature (see ↗ Chapter 10 'Metronome rhythm list' on page 33).

Alternatively, hold down *[SHIFT]* and set the desired time signature with the piano keys *[C3]...[A3]*.



– If you want to change the time signature with the piano keys *[C3]* to *[A3]*, always enter it in two-digit format. For example, to set the time signature '4/4 Beat', hold down *[SHIFT]* and press the piano keys *[A3]* and *[C#3]* in succession.

4. Adjusting the volume

Hold down *[SHIFT]* and use the piano keys *[D6]* or *[E6]* to adjust the volume.

5. Setting the tempo

All pre-programmed time signatures contain certain tempo information. You can set the tempo as described here ↗ Chapter 7.14 'Tempo' on page 23.

6. Turning off the metronome

Press ▶/■ to stop the metronome.

Alternatively, press *[MODE]* to switch to another mode.

⇒ The *[METRONOME]* LED goes out.



Metronome function is not available in song mode.

7.12 Local ON/OFF

This function separates the keyboard from the local sound generator of the instrument and causes MIDI data to be transmitted via a connected device such as a PC or external sound generator.

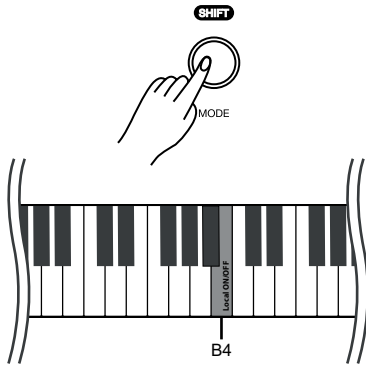

1. ➤ Press and hold [SHIFT] and press the piano key [B4] to activate the 'Local ON/OFF' function.
2. ➤ Press and hold [SHIFT] and press the piano key [B4] again to deactivate the 'Local ON/OFF' function.
⇒ The keyboard is separated from the local sound generator.



Local ON/OFF is activated by default.

7.13 Demo tracks

The demo tracks incorporated in the digital piano demonstrate the sound and the pitch range of the instrument.

1. Switching on demo tracks

To enable demo track playback, press **[MODE]** repeatedly until the **[SONG]** LED lights up.

2. Press ▶/■ to start playing demo tracks.

⇒ The LED of the ▶/■ button flashes.

3. Selecting demo tracks

These presets can be adjusted at any time in various ways.

- Press **[<]** or **[>]** to select a demo track in steps of 1 (see [Chapter 9 'Practise and demo tracks'](#) on page 31).
- Hold down **[<]** or **[>]** to set the tenth next demo track.



For example, if the current demo track # 1 is set, press and hold **[>]** to set demo track # 11.

- Hold down **[SHIFT]** and use the piano keys **[C3]** ... **[A3]** to enter a three-digit value to set the desired demo track directly.



– If you want to change the demo track using one of the piano keys **[C3]** to **[A3]**, always enter it in three-digit format. For example, to set the demo track 26, press the piano keys **[A3]**, **[C#3]** and **[F3]** in succession.

4. Adjusting the volume

Hold down **[SHIFT]** and use the piano keys **[D6]** or **[E6]** to adjust the volume.

5. Setting the tempo

All pre-programmed demo tracks contain certain tempo information. You can set the tempo as described here [Chapter 7.14 'Tempo'](#) on page 23.

6. Disabling demo tracks

Press ▶/■ to stop playing demo tracks.

Alternatively, press **[MODE]** to switch to another mode.

⇒ The **[SONG]** LED goes out.

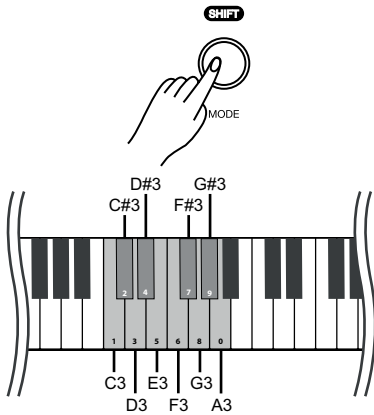

7.14 Tempo

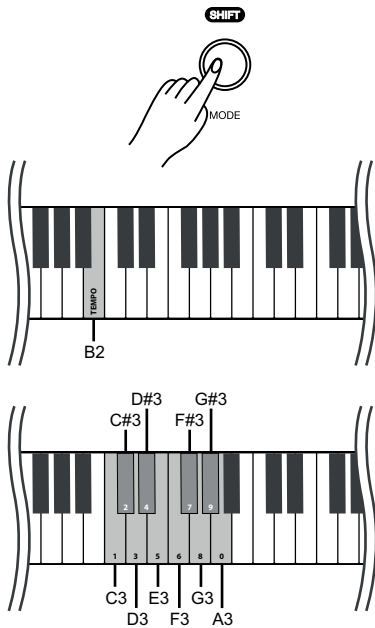

All pre-programmed songs and the metronome function are stored with certain tempo information. You can adjust the tempo in a range from '5' ... '320'. These pre-sets can be adjusted at any time in various ways.

1. Hold down **[SHIFT]** and quickly press **[<]** or **[>]** to adjust the tempo in steps of 1.
2. To set the tempo to the next tens digits, hold down **[SHIFT]** and press and hold **[<]** or **[>]** until the LED of the **[<]** or **[>]** button lights up.



*If the current tempo is 126 bpm, hold down **[SHIFT]** and press and hold **[>]**. The tempo jumps immediately to 130 bpm.*

3. Hold down **[SHIFT]** and press the piano key **[B2]**.
Keep holding down **[SHIFT]** and use the piano keys **[C3]** ... **[A3]** to enter a three-digit value to set the tempo directly.



- Hold down **[SHIFT]** and simultaneously press **[<]** and **[>]** to reset the tempo to the default value.
- If you want to change the tempo with the piano keys **[C3]** to **[A3]**, always enter it in three-digit format. For example, to set Tempo 214, hold down **[SHIFT]**, press **[B2]** and then press the piano keys **[C#3]**, **[C3]** and **[D#4]** in succession.
- When playback is ended in metronome mode, the tempo is reset by changing the time signature of the metronome.



*Many of the functions can be easily controlled from a mobile device using suitable apps (e.g. **PianoToolBox**), which can be downloaded from the App Store® or Google Play.*

7.15 Digital effects

7.15.1 Reverb and chorus

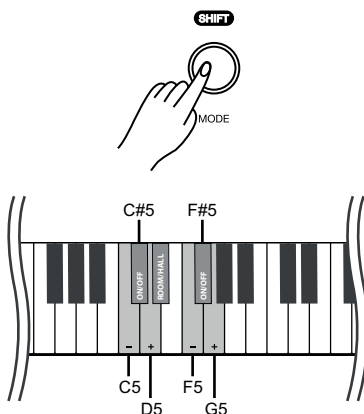

You can use the reverb and chorus functions to simulate acoustic effects in different ambient conditions.

On delivery, the reverb and chorus of the respective sound are activated by default.

1. Hold down **[SHIFT]** and turn on the desired effect with the piano key **[C#5]** (reverb) or **[F#5]** (chorus).
2. Hold down **[SHIFT]** and press **[D#5]**, to set the reverb type (Room or Hall).
3. Hold down **[SHIFT]** and adjust the effect depth in ten steps using the piano keys **[C5]** or **[D5]** for reverb and **[F5]** or **[G5]** for chorus.

7.16 TWINOVA

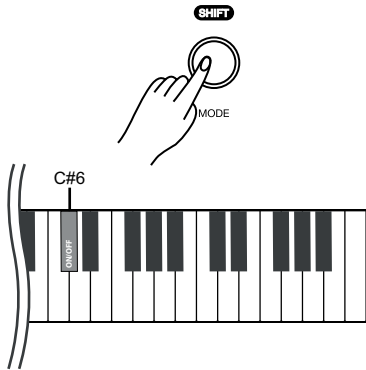

In TWINOVA mode, the keyboard is divided into two areas with the same sound and the same pitch to enable 4-handed playing, for example in class. The default split point is between [E4] and [F4].

1. ▶ Enabling TWINOVA

Hold down [SHIFT] and press piano key [C#6] to enter the TWINOVA mode.

2. ▶ Selecting a sound

The sound selected before input is set as the standard sound for both areas.

However, you can also choose another sound (see [Chapter 7.9 'Selecting sounds'](#) on page 17).



The layer and split function and the playback of demo pieces are not available in TWINOVA mode.

7.17 Recording function

You can record a user song with the digital piano and save the recording in the internal memory. If you record again, the saved user song will be overwritten.

7.17.1 Recording preparation

▶ To turn on the recording function, press [MODE] repeatedly until the [RECORD] LED lights up.

7.17.2 Recording

1. ▶ Hold down [SHIFT] and press [REC] to start recording.

⇒ The [RECORDING] LED flashes.

2. ▶ The recording starts with the first keystroke.

⇒ The [REC] button LED flashes.

7.17.3 Stopping recording

▶ Press [REC] to pause or stop recording.

⇒ The [REC] button LED turns off.

7.17.4 Playing a recording

1. ➤ To turn on the recording function, press *[MODE]* repeatedly until the *[RECORD]* LED lights up.
2. ➤ Press ▶/■ to play the saved recording.
 - ⇒ The LED of the ▶/■ button flashes.
3. ➤ Press ▶/■ again to stop the playback.
 - ⇒ The ▶/■ button LED turns off.

7.18 Further setting options

7.18.1 String resonance

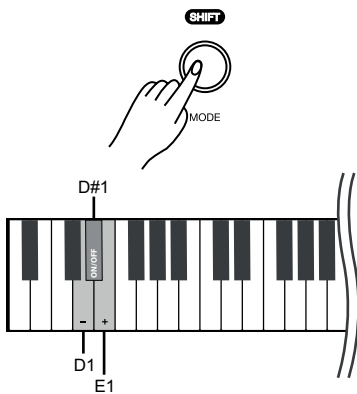

This function simulates the resonance effects taking place in an acoustic piano.

On delivery, the string resonance is activated by default.

1. ➤ Hold down *[SHIFT]* and press piano key *[D1]* or *[E1]* to adjust the string resonance.
2. ➤ Hold down *[SHIFT]* and press piano key *[D#1]* to disable the string resonance.
3. ➤ Hold down *[SHIFT]* and press piano key *[D#1]* again to enable the string resonance again.



This setting is only available for sounds no. 1 ... no. 4.

7.18.2 Damper resonance

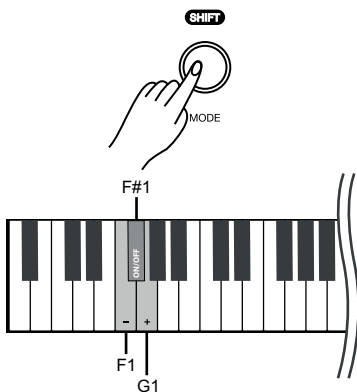

This function simulates the damper resonance effects with lifted dampers taking place in an acoustic piano.

On delivery, the damper resonance is activated by default.

1. ➤ Hold down *[SHIFT]* and press piano key *[F1]* or *[G1]* to adjust the damper resonance.
2. ➤ Hold down *[SHIFT]* and press piano key *[F#1]* to disable the damper resonance.
3. ➤ Hold down *[SHIFT]* and press piano key *[F#1]* again to enable the damper resonance again.



This setting is only available for sounds no. 1 ... no. 4.

7.18.3 Damper noise

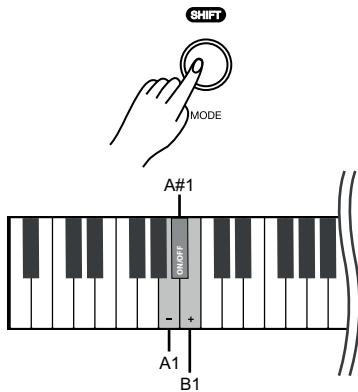

This function simulates the damper noise effects taking place in an acoustic piano when dampers are lifted and lowered.

On delivery, the damper noise is activated by default.

1. ➤ Hold down *[SHIFT]* and press piano key *[A1]* or *[B1]* to adjust the damper noise.
2. ➤ Hold down *[SHIFT]* and press piano key *[A#1]* to disable the damper noise.
3. ➤ Hold down *[SHIFT]* and press piano key *[A#1]* again to enable the damper noise again.



This setting is only available for sounds no. 1 ... no. 4.

7.18.4 Hammer noise

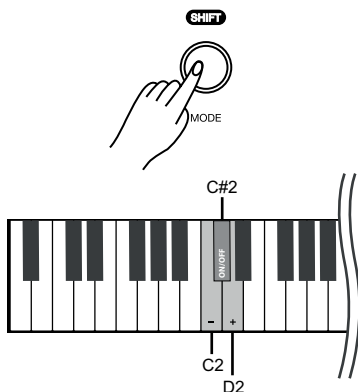

This function simulates the hammer noise effects taking place in an acoustic piano when striking the strings.

On delivery, the hammer noise is activated by default.

1. ➤ Hold down *[SHIFT]* and press piano key *[C2]* or *[D2]* to adjust the hammer noise.
2. ➤ Hold down *[SHIFT]* and press piano key *[C#2]* to disable the hammer noise.
3. ➤ Hold down *[SHIFT]* and press piano key *[C#2]* again to enable the hammer noise again.



This setting is only available for sounds no. 1 ... no. 4.



*Many of the functions can be easily controlled from a mobile device using suitable apps (e.g. **PianoToolBox**), which can be downloaded from the App Store® or Google Play.*

7.18.5 LID simulation

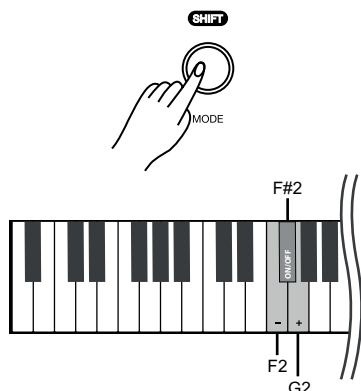

This function simulates the lid position of a piano or grand piano (open, half-open, closed).

1. ➤ Hold down [SHIFT] and press piano key [F2] or [G2] to adjust the lid simulation.
2. ➤ Hold down [SHIFT] and press piano key [F#2] to disable the lid simulation.
3. ➤ Hold down [SHIFT] and press piano key [F#2] again to enable the lid simulation again.



This setting is only available for sounds no. 1 ... no. 4.

7.19 MIDI functions

7.19.1 What is MIDI?

MIDI stands for 'Musical Instrument Digital Interface' and represents the standard interface between a computer and electronic instruments. You can use the USB port or the MIDI output socket of the digital piano for transferring MIDI data to a computer or other USB device.

7.19.2 USB connection

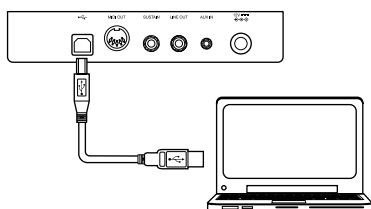

1. ➤ Connect the USB port of the digital piano using a standard USB cable (not included) to the USB port on your computer.



Use a current operating system still supported by the provider to avoid technical difficulties.

2. ➤ Heed the following guidelines when connecting instruments to a computer via USB. Otherwise, the instrument or the computer may 'crash', which can result in data loss. If a 'crash' should occur, turn off computer and instrument and restart both after a few seconds.



- *If the computer is in standby or hibernation, wake the computer before connecting the USB cable.*
- *Establish the USB connection between computer and instrument before turning on the instrument.*

7.19.3 MIDI connection

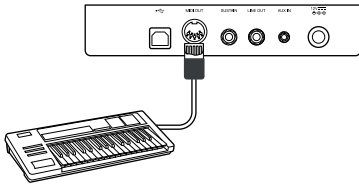

➔ With MIDI connections, the device that controls other devices is called the Master. A device that is controlled via MIDI is called Slave. Connect the MIDI OUT of the master to the MIDI IN of the slave.

7.19.4 Bluetooth® MIDI connection

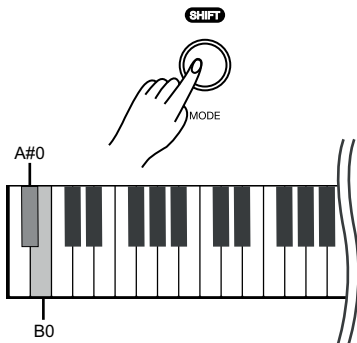

With the Bluetooth® connection, the digital piano can be paired with smartphones, tablets or other mobile devices to enable a wireless MIDI connection. You will find suitable apps (e.g. **PianoToolBox**) for controlling the digital piano for your mobile device in the App Store® or on Google Play.

- ➔ Switch on the digital piano and the mobile device.
- ➔ Activate the Bluetooth® connection on your mobile device.
- ➔ Open the app on your mobile device and pair it with the digital piano 'Piano BT MIDI xxxx'.
⇒ When the connection between digital piano and mobile device is established, the LED of the [POWER] button lights up blue.
- ➔ You can now control the digital piano from your mobile device.
- ➔ To disconnect the Bluetooth® connection, hold down [SHIFT] and simultaneously press the piano keys [A#0] and [B0].

7.20 Operating tone

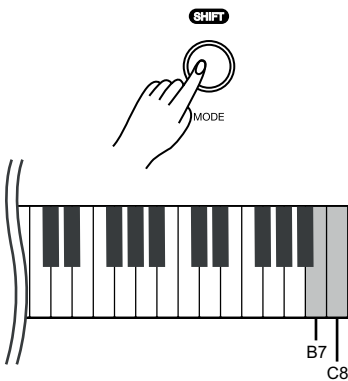

If a setting is made using key combinations, an operating tone sounds which can be switched on or off as required. By default, the operating tone is activated.

- ➔ Hold down [SHIFT] and then simultaneously press the piano keys [B7] and [C8] to deactivate the operating tone.
- ➔ To reactivate the operating tone, hold down [SHIFT] and then simultaneously press the piano keys [B7] and [C8].

7.21 Factory defaults

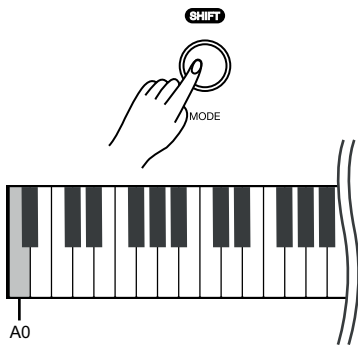

Proceed as follows to restore the factory default settings:

- ➔ Hold down *[SHIFT]* and press the piano key *[A0]* to activate the factory defaults.

8 Sound list

No.	Name	No.	Name	No.	Name
PIANO		009	Dark EP	017	Strings
001	German Grand	010	FM EP	018	Choir
002	Bright German Grand	KEYBOARD		019	Square Lead
003	Japanese Grand	011	Clavinet	020	Saw Lead
004	Warm Grand	012	Harpsichord	OTHER	
005	Electric Grand	013	Tonewheel Organ	021	Bell
EP		014	Classic Organ	022	Celesta
006	Vintage EP	015	Church Organ	023	Nylon Guitar
007	Warm EP	SYNTH		024	Electric Bass
008	Reed EP	016	Synth Pad	025	Acoustic Bass

9 Practise and demo tracks

No.	Name	No.	Name
001	Prelude In C-Sharp Major	031	The Wagtail
002	Lyrical Rondo	032	Bulie Dance
003	Rialto Ripples (Rag)	033	Tender Blossom
004	Neapolitan Song	034	Grace
005	Waltzes	035	Cherish The Memories
006	Turkish March	036	Chopsticks
007	Schos Doll's Dance No. 2	037	Progress
008	Minuet In D Major	038	Eclogue
009	Inquietude	039	The Limpid Stream
010	Italian Polka	040	Brave Cavalier
011	The Rag-Time Dance	041	The Chatterbox
012	Piano Sonata In C Major, K.330. III	042	Tarantella
013	Piano Sonata In A Major, K.331. I	043	Frankness
014	Waltz For Piano In G-Sharp Minor	044	Tender Grieving
015	L'Arabesque	045	The Farewell
016	Austria Variation	046	The Chase
017	Schos Doll's Dance No. 7	047	Sonata K.545
018	To A Wild Rose	048	Maple Leaves Ragtime
019	Innocence	049	The Nightingale Was Singing
020	Tchaikovsky Waltz	050	Gipsy Rondo
021	Barcarolle	051	Fountain
022	Robot Doll	052	Fur Elise
023	Consolation	053	Dove
024	Invention A 2 Voix	054	Knight
025	Minuet In G Major (BWV Anh. 114)	055	Ave Maria
026	Barcarolle	056	Prelude in G BWV902a
027	Norwegian Dance No.2	057	The Angels Singing
028	Moseta Dance	058	The Entertainer
029	The Small Gathering	059	Swallow
030	The Return	060	Minute Waltz

Practise and demo tracks

No.	Name	No.	Name
061	Danse Des Mirlitons	081	House Of Rising
062	Wedding March	082	The Blue Bells
063	The Hip Hop's Night	083	Beautiful Dreamer
064	Prelude And Fugue No. 30 In D Minor	084	Been A Long Time
065	Minuets In F	085	O Sole Mio
066	Red River Valley	086	Der Deitcher's Dog
067	Troika	087	Joy To The World
068	Oh Susanna	088	Silent Night
069	Wave Of Danube	089	Ave Maria
070	Long Long Ago	090	Five Hundred Miles
071	Old Folks At Home	091	Happy New Year
072	Jambalaya	092	Like Christmas
073	Ding! Dong!	093	Jeanie With The Light Brown Hair
074	Battle Hymn	094	Music Box Dancer
075	The Old Gray Mare	095	Tell It On Mountain
076	American Patrol	096	Entertainer
077	Christmas Coming	097	Annie Laurie
078	Sipping Cider	098	Rumba Romance
079	Christmas Sound	099	The Last Rose Of Summer
080	On London Bridge	100	The Old King Cole

10 Metronome rhythm list

No.	Name	No.	Name	No.	Name
01	Simple Count	18	70's Rock	35	Funk 2
02	4/4 Beat	19	Texas Rock	36	Swing 1
03	2/4 Beat	20	Sweet Ballad	37	Swing 2
04	3/4 Beat	21	6/8 Soul	38	Funky Jazz
05	3/8 Beat	22	Fusion Shuffle	39	Bernard Shuffle
06	6/8 Beat	23	Adult Ballad	40	Bluegrass
07	5/4 Beat	24	Organic Ballad	41	Country Step
08	5/8 Beat	25	Tango	42	Country Folk
09	7/8 Beat	26	Slow Waltz	43	Bossa Nova
10	10/8 Beat	27	Cha Cha	44	Latin
11	8Beat 1	28	Rumba	45	Mambo
12	8Beat 2	29	Samba	46	Waltz
13	16Beat 1	30	Techno 1	47	Vienna Waltz
14	16Beat 2	31	Hip Hop	48	Polka
15	Rock	32	Techno 2	49	March
16	Ska	33	Classic Disco	50	6/8 March
17	Slow Rock	34	Funk 1		

11 MIDI implementation chart

Function		Sent	Received	Notes
Basic Channel	Default	1	1-16	
	Changed	1-16	1-16	
Mode	Default	No	Mode 3	
	Messages	No	Mode 3	
	Altered	*****	No	
Note Number	Note	0 – 127	0 – 127	
	True voice	*****	0 – 127	
Velocity Note	Note ON	Yes, 9nH, v = 1 – 127	Yes, 9nH, v = 1 – 127	
	Note OFF	No, 9nH, v = 0 or 8nH, v = 0 – 127	Yes, 9nH, v = 0 or 8nH, v = 0 – 127	
After Touch	Keys	No	No	
	Channels	No	No	
Pitch Bend		No	Yes	
Control Change	0	Yes	Yes	Bank Select
	1	No	Yes	Modulation
	5	No	Yes	Portamento Time
	6	No	Yes	Data Entry
	7	Yes	Yes	Volume
	10	No	Yes	Pan
	11	No	Yes	Expression
	64	Yes	Yes	Sustain Pedal
	65	No	Yes	Portamento ON/OFF
	66	No	Yes	Sostenuto Pedal
	67	No	Yes	Soft Pedal
	80	Yes	Yes	Reverb Program
	81	Yes	Yes	Chorus Program
	91	Yes	Yes	Reverb Level
	93	Yes	Yes	Chorus Level
120	No	Yes	All Sound Off	
121	No	No	Reset All Controllers	
123	No	Yes	All Notes Off	
Program Change	True #	Yes	Yes	Bank MSB, Bank LSB, Programm
System Exclusive		No	Yes	
System Common	Song Position	No	No	

Function		Sent	Received	Notes
	Song Select	No	No	
	Tune Request	No	No	
System Real Time	Clock	Yes	No	
	Commands	No	No	
Aux Messages	Local ON/OFF	No	No	
	Active Sensing	Yes	No	
	System Reset	No	Yes	

MIDI channel modes

	POLY	MONO
OMNI ON	Mode 1	Mode 2
OMNI OFF	Mode 3	Mode 4

12 Troubleshooting

Problem	Possible causes and solutions
You hear a 'pop' sound from the speakers when switching the digital piano on and off.	This is normal. No need to worry.
No sound can be heard when playing the piano.	<p>Make sure that the volume control is set appropriately.</p> <p>Check if headphones are plugged into headphone output 1 or 2. Connecting headphones will mute the speakers of the digital piano.</p>
Malfunction occurs when using a mobile phone.	Using a mobile phone near the digital piano can cause interference. To prevent this, turn off the mobile phone or use it only at a safe distance.
Some notes on the keyboard sound wrong.	Reset the tuning to the default setting and restart the device.
The digital piano is not detected when connected to a computer.	<p>Check the USB cable for correct connection.</p> <p>Connect the USB cable to another USB port on the computer.</p>

13 Technical specifications

Input connections	AUX IN	1 × 3.5 mm jack socket	
Output connections	Headphones	1 × 6.35 mm (1/4 inch) jack socket, 1 × 3.5 mm jack socket	
	MIDI OUT	1 × DIN socket, 5-pin	
	LINE OUT	1 × 6.35 mm (1/4 inch) jack socket	
	USB MIDI	1 × USB-to-host interface	
	Pedal	1 × 6.35 mm (1/4 inch) jack socket	
Keyboard	88 weighted keys with hammer action		
Polyphony	192-voice polyphonic		
Sounds	25		
Styles	50		
Effects	Chorus, reverb		
Pedal	Sustain pedal		
Demo and practice tracks	100		
Bluetooth®	Frequency range	2,379 MHz ... 2,496 MHz	
	Max. transmission power	10 dBm	
	Standard	Version 4.0	
	Bluetooth® name	Piano BT MIDI xxxx	
Operating system	Windows 8 and later, Mac OS X® 10.8 and later		
Speakers	2 × 20 W		
Power supply	External power adapter, 100 - 240 V ~ 50/60 Hz		
Operating voltage	12 V $\overline{\text{---}}$ / 2,000 mA, centre positive		
Dimensions (W × H × D)	1,365 mm × 134 mm × 366 mm		
Weight	12.5 kg		
Colour	Black	item no. 493572	
	White	item no. 520276	
Ambient conditions	Temperature range	0 °C...40 °C	
	Relative humidity	20%...80% (non-condensing)	

Further information

Pitch Bend	No
Modulation wheel	No
Number of split zones	2
Ivory-feel keyboard	No
Storage medium	No
Stand	Optional (item no. 352262)

14 Plug and connection assignment

Introduction

This chapter will help you select the right cables and plugs to connect your valuable equipment in such a way that a perfect sound experience is ensured.

Please note these advices, because especially in 'Sound & Light' caution is indicated: Even if a plug fits into the socket, an incorrect connection may result in a destroyed power amp, a short circuit or 'just' in poor transmission quality!

Unbalanced transmission

Unbalanced transmission is mainly used in semi-professional environment and in hifi use. Instrument cables with two conductors (one core plus shielding) are typical representatives of the unbalanced transmission. One conductor is ground and shielding while the signal is transmitted through the core.

Unbalanced transmission is susceptible to electromagnetic interference, especially at low levels, such as microphone signals and when using long cables.

1/4" TRS phone plug (stereo, unbalanced)



1	Signal (left)
2	Signal (right)
3	Ground

Three-pole 1/8" mini phone jack (stereo, unbalanced)



1	Signal (left)
2	Signal (right)
3	Ground, shielding

15 Protecting the environment

Disposal of the packing material



Environmentally friendly materials have been chosen for the packaging. These materials can be sent for normal recycling. Ensure that plastic bags, packaging, etc. are disposed of in the proper manner.

Do not dispose of these materials with your normal household waste, but make sure that they are collected for recycling. Please follow the instructions and markings on the packaging.



Observe the disposal note regarding documentation in France.

Disposal of your old device



This product is subject to the European Waste Electrical and Electronic Equipment Directive (WEEE) as amended.

Do not dispose of your old device with your normal household waste; instead, deliver it for controlled disposal by an approved waste disposal firm or through your local waste facility. When disposing of the device, comply with the rules and regulations that apply in your country. If in doubt, consult your local waste management facility. Proper disposal protects the environment as well as the health of your fellow human beings.

Also note that waste avoidance is a valuable contribution to environmental protection. Repairing a device or passing it on to another user is an ecologically valuable alternative to disposal.

You can return your old device to Thomann GmbH at no charge. Check the current conditions on www.thomann.de.

If your old device contains personal data, delete those data before disposing of it.

