



DIGITAL SAXOPHONE

YDS-150

取扱説明書

Owner's Manual

Benutzerhandbuch

Mode d'emploi

Manual de instrucciones

Manual do Proprietário

Руководство пользователя

사용설명서

使用说明书

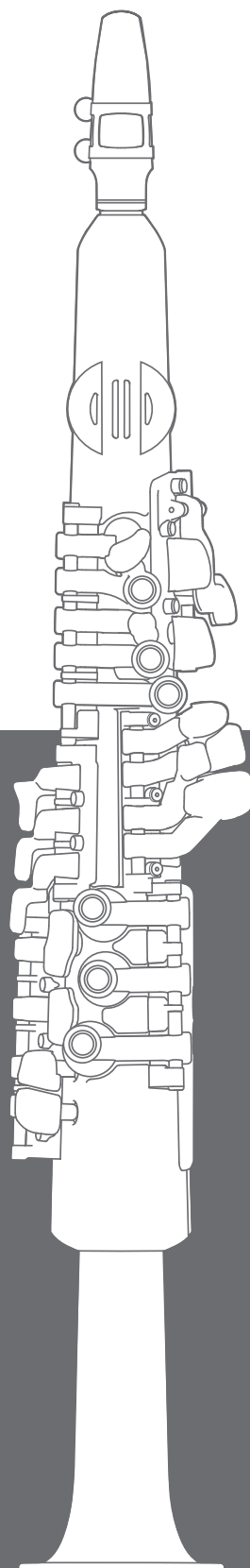

日本語

English

Deutsch

Français

Español

Português

Русский

한국어

中文

JA EN DE FR ES PT RU KO ZH

EN SIMPLIFIED EU DECLARATION OF CONFORMITY

Hereby, Yamaha Music Europe GmbH declares that the radio equipment type [model 1, model 2, model 3] is in compliance with Directive 2014/53/EU. The full text of the EU declaration of conformity is available at the following internet address:

<https://europe.yamaha.com/en/support/compliance/doc.html>

FR DECLARATION UE DE CONFORMITE SIMPLIFIEE

Le soussigné, Yamaha Music Europe GmbH, déclare que l'équipement radioélectrique du type [model 1, model 2, model 3] est conforme à la directive 2014/53/UE. Le texte complet de la déclaration UE de conformité est disponible à l'adresse internet suivante:

<https://europe.yamaha.com/en/support/compliance/doc.html>

DE VEREINFACHTE EU-KONFORMITÄTSEKTLÄRUNG

Hiermit erklärt Yamaha Music Europe GmbH, dass der Funkanlagentyp [model 1, model 2, model 3] der Richtlinie 2014/53/EU entspricht. Der vollständige Text der EU-Konformitätserklärung ist unter der folgenden Interneta-dresse verfügbar:

<https://europe.yamaha.com/en/support/compliance/doc.html>

ES DECLARACIÓN UE DE CONFORMIDAD SIMPLIFICADA

Por la presente, Yamaha Music Europe GmbH declara que el tipo de equipo radioeléctrico [model 1, model 2, model 3] es conforme con la Directiva 2014/53/UE. El texto completo de la declaración UE de conformidad está disponible en la dirección Internet siguiente:

<https://europe.yamaha.com/en/support/compliance/doc.html>

PT DECLARAÇÃO UE DE CONFORMIDADE SIMPLIFICADA

O(a) abaixo assinado(a) Yamaha Music Europe GmbH declara que o presente tipo de equipamento de rádio [model 1, model 2, model 3] está em conformidade com a Diretiva 2014/53/UE. O texto integral da declaração de conformidade está disponível no seguinte endereço de Internet:

<https://europe.yamaha.com/en/support/compliance/doc.html>

Importer: Yamaha Music Europe GmbH

Siemensstrasse 22-34, 25462 Rellingen, Germany

- Radio Frequency (Operational Frequency).....2402 MHz to 2480 MHz
- Maximum Output Power (EIRP)4.0 dBm (2.5 mW)

This device complies with Industry Canada's licence-exempt RSSs. Operation is subject to the following two conditions:

- (1) This device may not cause interference; and
- (2) This device must accept any interference, including interference that may cause undesired operation of the device.

This equipment complies with IC radiation exposure limits set forth for an uncontrolled environment and meets RSS-102 of the IC radio frequency (RF) Exposure rules. This equipment has very low levels of RF energy that is deemed to comply without testing of specific absorption rate (SAR).

This transmitter must not be co-located or operated in conjunction with any other antenna or transmitter.

This equipment complies with FCC radiation exposure limits set forth for an uncontrolled environment and meets the FCC radio frequency (RF) Exposure Guidelines. This equipment has very low levels of RF energy that is deemed to comply without testing of specific absorption rate (SAR).

PRECAUTIONS

PLEASE READ CAREFULLY BEFORE PROCEEDING

Please keep this manual in a safe and handy place for future reference.



WARNING

Always follow the basic precautions listed below to avoid the possibility of serious injury or even death from electrical shock, short-circuiting, damages, fire or other hazards. These precautions include, but are not limited to, the following:

Power

- Do not place the USB cable near heat sources such as heaters or radiators. Also, do not excessively bend or otherwise damage the cord, or place heavy objects on it.
- Only use the voltage specified as correct for the instrument. The required voltage is printed on the name plate of the instrument.
- Check the electric plug periodically and remove any dirt or dust which may have accumulated on it.

Do not open

- This instrument contains no user-serviceable parts. Do not open the instrument or attempt to disassemble or modify the internal components in any way. If it should appear to be malfunctioning, discontinue use immediately and have it inspected by qualified Yamaha service personnel.

Water warning

- Do not expose the instrument to rain, use it near water or in damp or wet conditions, or place on it any containers (such as vases, bottles or glasses) containing liquids which might spill into any openings. If any liquid such as water seeps into the instrument, turn off the power immediately and unplug the power cord from the AC outlet. Then have the instrument inspected by qualified Yamaha service personnel.
- Never insert or remove an electric plug with wet hands.

Fire warning

- Do not put burning items, such as candles, on the unit. A burning item may fall over and cause a fire.

Influences on electro-medical devices

- Radio waves or magnetism may affect electro-medical devices.
 - Do not use this product near medical devices or inside areas in which the use of radio waves is restricted.
 - Do not use this product within 15cm (6 in.) of persons with a heart pacemaker or defibrillator implant.

Battery

- Follow the precautions below. Failure to do so might result in explosion, fire, overheating or battery fluid leakage.
 - Do not tamper with or disassemble batteries.
 - Do not dispose of batteries in fire.
 - Do not attempt to recharge batteries that are not designed to be charged.
 - Keep the batteries separate from metallic objects such as necklaces, hairpins, coins, and keys.
 - Use the specified battery type (page 15) only.
 - Use new batteries, all of which are the same type, same model, and made by the same manufacturer.
 - Always make sure all batteries are inserted in conformity with the +/- polarity markings.
 - When the batteries run out, or if the instrument is not to be used for a long time, remove the batteries from the instrument.
 - When using Ni-MH batteries, follow the instructions that came with the batteries. Use only the specified charger device when charging.
- Keep batteries away from small children who might accidentally swallow them.
- If the batteries do leak, avoid contact with the leaked fluid. If the battery fluid should come in contact with your eyes, mouth, or skin, wash immediately with water and consult a doctor. Battery fluid is corrosive and may possibly cause loss of sight or chemical burns.

If you notice any abnormality

- When one of the following problems occur, immediately turn off the power switch and disconnect the electric plug from the outlet. (If you are using batteries, remove all batteries from the instrument.) Then have the device inspected by Yamaha service personnel.
 - The USB cable or plug becomes frayed or damaged.
 - It emits unusual smells or smoke.
 - Some object has been dropped into the instrument.
 - There is a sudden loss of sound during use of the instrument.
 - If any cracks or breakages exist on the instrument.

CAUTION

Always follow the basic precautions listed below to avoid the possibility of physical injury to you or others, or damage to the instrument or other property. These precautions include, but are not limited to, the following:

Power

- Do not connect the instrument to an electrical outlet using a multipleconnector. Doing so can result in lower sound quality, or possibly cause overheating in the outlet.
- When removing the electric plug from the instrument or an outlet, always hold the plug itself and not the USB cable. Pulling by the USB cable can damage it.
- Remove the electric plug from the outlet when the instrument is not to be used for extended periods of time, or during electrical storms.
- Use the specified USB power adaptor (page 10) only. Using the wrong adaptor can result in damage to the instrument or overheating.

Location

- Do not place the instrument in an unstable position where it might accidentally fall over.
- Before moving the instrument, remove all connected cables, to prevent damage to the cables or injury to anyone who might trip over them.
- When using an electric plug, make sure that the AC outlet you are using is easily accessible in plain view. If some trouble or malfunction occurs, immediately turn off the power switch and disconnect the plug from the outlet. Even when the power switch is turned off, electricity is still flowing to the product at the minimum level. When you are not using the product for a long time, make sure to disconnect the plug from the wall AC outlet.

Connections

- Before connecting the instrument to other electronic components, turn off the power for all components. Before turning the power on or off for all components, set all volume levels to minimum.
- Be sure to set the volumes of all components at their minimum levels and gradually raise the volume controls while playing the instrument to set the desired listening level.

Handling

- Do not insert a finger or hand in any gaps on the instrument.
- Never insert or drop paper, metallic, or other objects into the gaps on the panel or keys. This could cause physical injury to you or others, damage to the instrument or other property, or operational failure.
- Do not rest your weight on, or place heavy objects on the instrument, and do not use excessive force on the buttons, switches or connectors.
- Do not use the instrument if the mouthpiece, reed or ligature is damaged.
- Keep small parts out of the reach of infants. Your children may accidentally swallow them.
- Do not use the instrument/device or headphones for a long period of time at a high or uncomfortable volume level, since this can cause permanent hearing loss. If you experience any hearing loss or ringing in the ears, consult a physician.
- When using a strap, make sure the strap is securely attached to the instrument.
- Do not lift the instrument by the strap. It can cause serious injury or damage to the instrument.
- Do not treat the instrument in a rough manner such as swinging it about, etc. The strap on the instrument may detach causing unexpected accidents such as the instrument dropping, etc., or injuring persons close by.

Yamaha cannot be held responsible for damage caused by improper use or modifications to the instrument, or data that is lost or destroyed.

Always turn the power off when the instrument is not in use.

Even when the [] (Standby/On) switch is in standby status (power lamp is off), electricity is still flowing to the instrument at the minimum level.

When you are not using the instrument for a long time, make sure you unplug the power cord from the wall AC outlet.

Make sure to discard used batteries according to local regulations.

NOTICE

To avoid the possibility of malfunction/ damage to the product, damage to data, or damage to other property, follow the notices below.

■ Handling

- Do not connect this product to public Wi-Fi and/or Internet directly. Only connect this product to the Internet through a router with strong password-protections. Consult your router manufacturer for information on security best practices.
- Do not use the instrument in the vicinity of a TV, radio, stereo equipment, mobile phone, or other electric devices. Otherwise, the instrument, TV, or radio may generate noise. When you use the instrument along with an application on your smart device such as a smartphone or tablet, we recommend that you set Bluetooth to on after setting "Airplane Mode" to on on that device in order to avoid noise caused by communication.
- Do not expose the instrument to excessive dust or vibrations, or extreme cold or heat (such as in direct sunlight, near a heater, or in a car during the day) to prevent the possibility of panel disfiguration, damage to the internal components or unstable operation. (Verified operating temperature range: 5° – 40°C, or 41° – 104°F.)
- Do not place vinyl, plastic or rubber objects on the instrument, since this might discolor the panel or keyboard.
- Do not leave the instrument for a long period of time with a key pressed, since this might damage the key.

■ Maintenance

- When cleaning the instrument, use a soft cloth. Do not use paint thinners, solvents, alcohol, cleaning fluids, or chemical-impregnated wiping cloths.
- Be careful not to expose the instrument to water. If any water gets on the instrument, wipe it off using a dry cloth.

Information

■ About this manual

- The illustrations and LED displays as shown in this manual are for instructional purposes only, and may appear somewhat different from those on your instrument.
- The Bluetooth® word mark and logos are registered trademarks owned by Bluetooth SIG, Inc. and any use of such marks by Yamaha Corporation is under license.



- The company names and product names in this manual are the trademarks or registered trademarks of their respective companies.

About Bluetooth

Bluetooth is a technology for wireless communication between devices within an area of about 10 meters (33 ft.), and employs the 2.4 GHz frequency band.

■ Handling Bluetooth communications

- The 2.4 GHz band used by Bluetooth compatible devices is a radio band shared by many types of equipment. While Bluetooth compatible devices use a technology minimizing the influence of other components using the same radio band, such influence may reduce the speed or distance of communications and in some cases interrupt communications.
- The speed of signal transfer and the distance at which communication is possible differs according to the distance between the communicating devices, the presence of obstacles, radio wave conditions and the type of equipment.
- Yamaha does not guarantee all wireless connections between this unit and devices compatible with Bluetooth function.

Your particular instrument does not have Bluetooth capability if a "Y" indication is printed on the upperright corner of the label at the bottom.

Thank you for purchasing the Yamaha Digital Saxophone! This digital saxophone can be used for playing and practicing at home. We recommend that you read this manual carefully so that you can fully take advantage of the advanced and convenient functions of the instrument. We also recommend that you keep this manual in a safe and handy place for future reference.

Included Accessories

- **Mouthpiece set (mouthpiece, ligature, cap, reed) × 1**

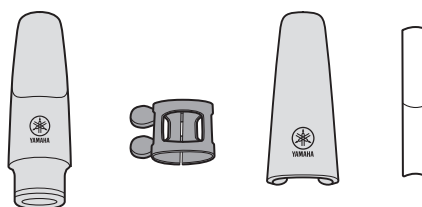

- **Strap × 1**

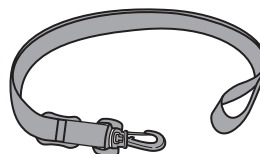

NOTE

- The strap is stored in the pocket inside the special case.

- **Replacement O-ring × 1 set (3 pieces included)**

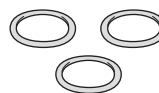

- **Replacement reed × 1**



- **Special case × 1**

NOTICE

- Make sure to only store this instrument and the strap inside the special case, since storing other things might damage the keys.

- **Owner's Manual × 1**

Controls and Functions

Front side

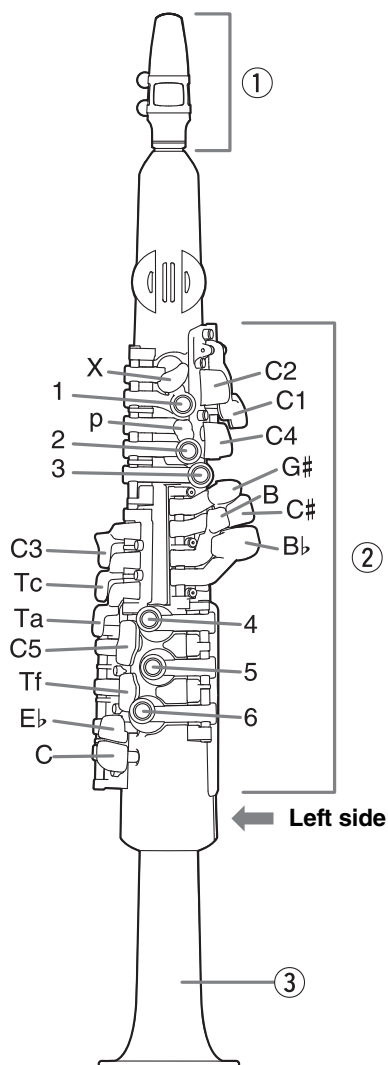

Left side

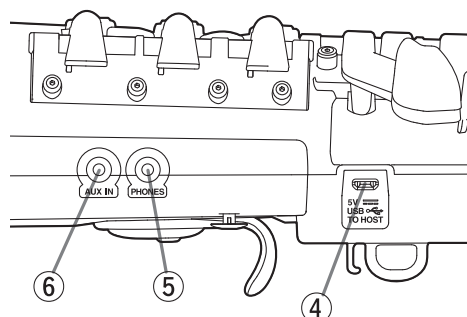

① Mouthpiece set

For use exclusively with this instrument.

② Keys

(Fingering Chart: page 20)

③ Bell

There is a water drain inside the bell. Water condensation and excess breath moisture can be drained from here.

④ 5 V DC-IN/USB TO HOST terminal

Micro USB Type-B terminal.

For connection to a USB power adaptor, USB mobile battery, or PC with a USB cable.

NOTICE

- Use a USB A to micro B cable of less than 3 meters. Do not use a USB 3.0 cable.

⑤ PHONES jack

For connecting a pair of stereo headphones or other equipment with a mini stereo phone plug (3.5 mm). The instrument's built-in speakers automatically stop producing sound when plugged in.

⚠ CAUTION

- To prevent hearing loss, avoid using headphones at high volumes for extended periods of time.
- Before connecting the instrument to other electronic components, turn off the power for all components. Before turning the power on or off for all components, set all volume levels to minimum. This can cause permanent hearing loss.

⑥ AUX IN jack

For inputting the sound of an audio player and listening to it through the built-in speaker of the instrument (with a 3.5 mm, mini stereo phone plug). To adjust the input volume from the [AUX IN] jack, adjust the audio playback volume on the audio device.

⚠ CAUTION

- To avoid possible damage, first turn on the power for the external device, and then for the instrument. When turning off the power, first turn off the power for the instrument, and then for the external device. This can cause permanent hearing loss.

NOTE

- Use an appropriate adaptor plug if the output jack of the audio device does not match the stereo mini phone plug of the audio cable.
- Use audio cables and adaptor plugs that have no series resistors.

Back side

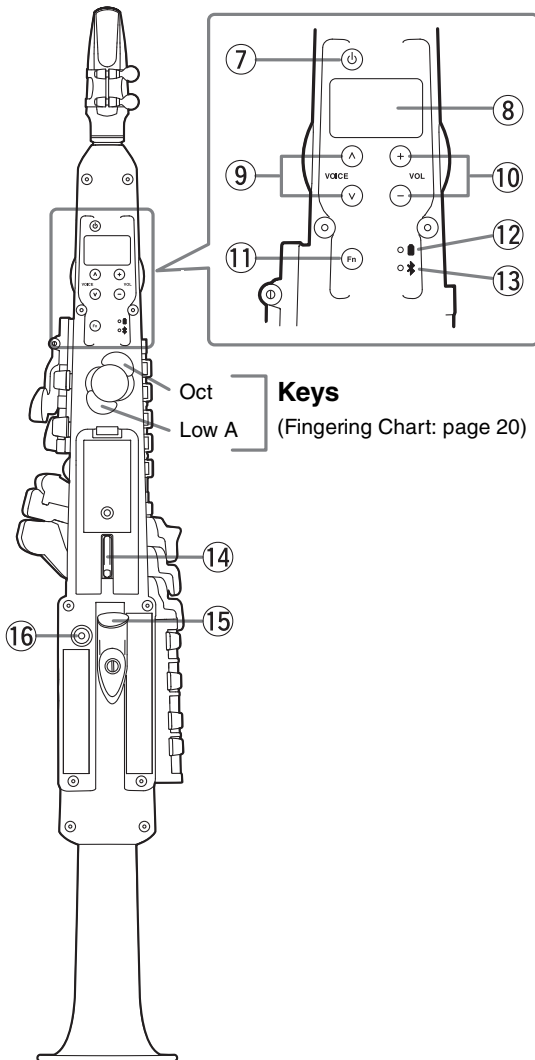

Laying the Instrument Down

When the instrument is not being played, place it on a flat surface as shown in the illustration below. Do not place the instrument on a chair, music stand, or other such unstable surface, as there is a risk of the instrument falling. Also, never lean the instrument up against a wall, etc.

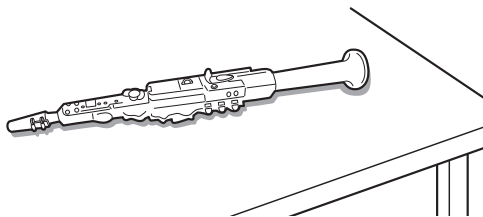

NOTICE

- Do not stand the instrument up by itself. Doing so can cause damage to the instrument due to the impact if it falls down. If you want to stand the instrument up, please use a commercially available stand.

⑦ [⏻] (Standby/On) button

Press this button to turn on the instrument.

⑧ LED screen

Displays information such as the Voice number in alphanumeric characters.

⑨ VOICE [^]/[v] buttons

Changes the Voice each time a button is pressed.

⑩ VOL [-]/[+] buttons

Raises or lowers the instrument volume each time a button is pressed. Press and hold a button to change the volume quickly.

- Setting range: 0 to 15, od (Default: 13)
- Press the VOL [-] button and VOL [+] button simultaneously to restore the default volume setting.

⑪ [Fn] (Function) button

Press specific keys while holding this button to call up various functions. This is also used to operate some functions.

⑫ Power lamp

⑬ Bluetooth lamp

⑭ Strap ring

Attach the included strap to this ring.

How to Attach the Strap

Firmly attach the included strap to the ring. You can easily change the length of the strap to adjust it to a length that is easy for you to use.

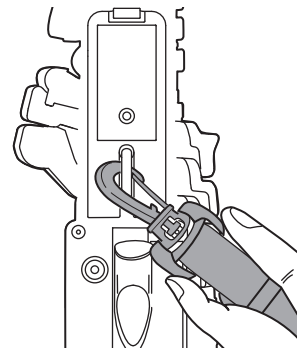

⑮ Thumb hook

Use this hook to support the instrument with your thumb when playing. Wrap your right thumb around the thumb hook to hold the instrument firmly.

⑯ Analog controller

Used to apply changes to the Voice.

Before Playing

■ Power Requirements

This instrument can be powered in one of the two ways listed below. Determine which you intend to use, and follow the instructions for setting up.

NOTICE

- If you connect the instrument to a commercially available USB power adaptor or USB mobile battery while batteries are in the instrument, priority is given to power from the USB cable.

Using batteries

This instrument requires four “AAA” size, alkaline (LR3) batteries or rechargeable nickel-metal hydride batteries (rechargeable Ni-MH batteries).

- 1 Make sure that the power of the instrument is off.**
The power lamp () will be off when the power is off.
- 2 Place the instrument upside-down on a soft cloth and remove the battery cover.**
- 3 Insert the four new batteries, being careful to follow the polarity markings on the inside of the compartment.**

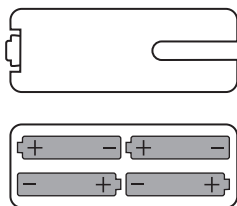

● Remaining Battery Power

When the remaining battery power drops to about 5 or 10 minutes*, the POWER LED lamp () flashes. Furthermore, when there is almost no remaining power, the POWER LED lamp turns off and the instrument enters standby mode.

- * Varies depending on the usage environment.

NOTE

- You should check the Power lamp frequently and take precautions that the battery does not run out during a performance.

Using a USB power adaptor or USB mobile battery (sold separately)

Connect the USB cable to a USB power adaptor or USB mobile battery (sold separately) in the order shown in the illustration. Follow the order shown here in reverse when disconnecting the USB cable.

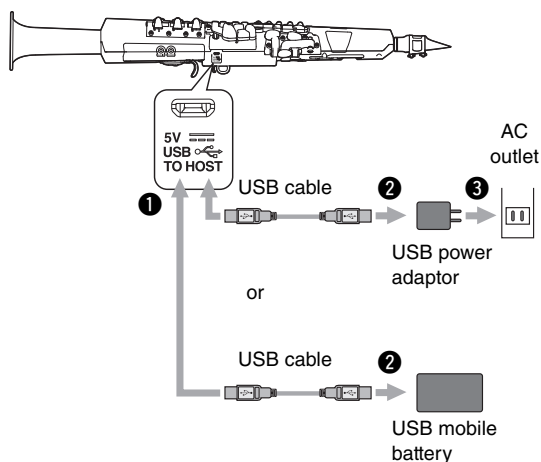

- **Use only a USB power adaptor or USB mobile battery compatible with the USB standard for power supply.**

Output voltage 4.8 V to 5.2 V
Output current 1.0 A or greater

CAUTION

- **Before using a USB power adaptor or USB mobile battery, be sure to read the relevant precautions.**

■ Turning on the Power / Setting to Standby

1 Press the [⏻] (Standby/On) button to turn the power on.

The power lamp (🔦) is lit in red when the power is on. Adjust the volume as desired while blowing into the mouthpiece.



⚠ CAUTION

- Do not use the instrument or headphones for a long period of time at a high or uncomfortable volume level, since this can cause permanent hearing loss.

NOTICE

- While turning on the power, do not attempt any other operations, such as blowing into the mouthpiece. Doing so may cause the instrument to malfunction.

2 Press and hold the [⏻] (Standby/On) button for longer than one second to enable standby mode.

⚠ CAUTION

- Even when in standby mode, an electric current is still flowing in the instrument at the minimum level. When you are not using the instrument for a long time, make sure to disconnect the USB power adaptor from the AC outlet, or remove the batteries from the instrument.

NOTE

- If over 5 seconds elapses with no keys or buttons operated since the power was turned on, the LED display turns off. Simply operate any button or move the instrument to turn the LED display on again.

● Enabling / Disabling Auto Power Off

To prevent unnecessary power consumption, this instrument features an Auto Power Off function that automatically turns the power off if the instrument is not operated for a specified period of time (30 minutes). By default, it is set to On; however, this setting can be changed with the [Fn] button.

NOTICE

- If your instrument is connected to other equipment such as amplifiers and speakers but you do not intend to use it for 30 minutes, we recommend that you turn off all devices as described in the corresponding owner's manuals. Doing so eliminates the risk of damage to the other equipment. If you do not want the instrument to turn off automatically when connected to other equipment, disable the Auto Power Off function.

■ Adjusting the Instrument Volume

Adjust the volume.

The volume is increased by 1 each time VOL [+] is pressed. The volume is decreased by 1 each time VOL [-] is pressed. You can adjust the volume in a range of 0 to 15, od. The default value is 13.



- * The "od" (overdrive) setting is the maximum volume, for the most powerful sound. Keep in mind that there may be distortion in the sound for specific Voices and in the lower ranges.

■ Initialization

Perform this operation when you want to reset all settings to their factory defaults.

- 1 If the power is on, turn the power off.
- 2 Turn the power on while holding keys [1], [p], and [3].

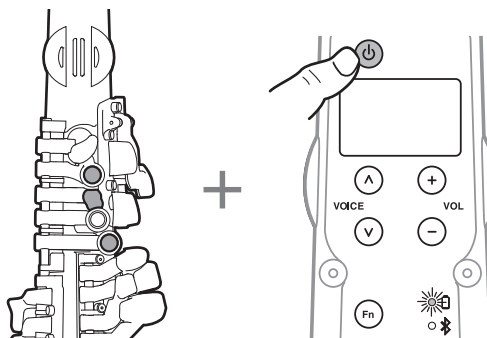

Playing the Instrument

■ Mouth Shape

Position the mouthpiece in your mouth with your upper front teeth resting about 1cm from the tip of the mouthpiece. Cover your lower teeth with your lower lip to keep your teeth from coming into direct contact with the reed.

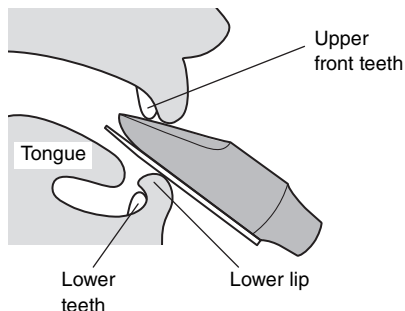

With the reed resting on your lower lip, seal your mouth around the mouthpiece to keep air from leaking out of the corners of your mouth when blowing.

* Do not bite hard on the reed or mouthpiece.

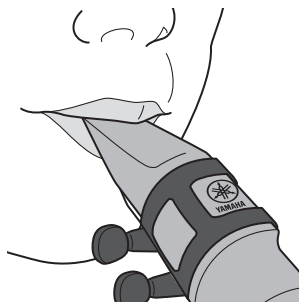

■ How to Play Sound

Put the mouthpiece into your mouth and blow. Blow strongly for a higher volume, and softly for a lower volume. There is no need to vibrate the reed like an acoustic saxophone.

NOTE

- Unlike an acoustic saxophone, changing the degree to which the mouthpiece is inserted into the neck will not change the pitch of the sound.

■ Selecting a Voice

It is possible to select a Voice and tonality you like, such as an alto saxophone, tenor saxophone, etc.

1 Press VOICE [^]/[v].

The Voice number is displayed on the LED display. For the Voice names, refer to the Voice List on page 19.



The display on the LED screen has the following meanings.

- R.01* to *R.17* : Alto sax Voices (in E \flat)
- S.01* to *S.13* : Soprano sax Voices (in B \flat)
- T.01* to *T.15* : Tenor sax Voices (in B \flat)
- b.01* to *b.11* : Baritone sax Voices (in E \flat)
- C.01* to *C.17* : Non-sax Voices (in C)
- U.01* to *U.20* : You can select user Voices edited in the dedicated app (page 14). For details, refer to the manual for the dedicated app.

Using the Analog Controller

The analog controller has functions assigned by default depending on the selected Voice.

- Raising or lowering the pitch (Pitch Bend)
- Applying vibrato to the sound. (Modulation)
- Smoothing out the pitch slide between notes (Portamento)

For details about the functions assigned to the analog controller for each Voice, see the Voice List at the end of this document.

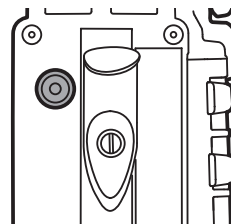

NOTE

- Portamento is a playing technique that smoothly slides the pitch of the performance up and down. When using a Voice with portamento assigned to it, move the thumb controller to smoothly change the pitch.

Changing Settings with the [Fn] Button

Press specific keys while holding the [Fn] button to perform settings for the various functions of the instrument.

Basic operations

Use the following procedure to perform settings for each function.

- 1 While holding the [Fn] button, press the key to which the function is assigned. Hold the [Fn] button until you finish performing settings. If you release the button, the value at that moment is set and operation returns to the Voice selection screen.

Example: Tuning

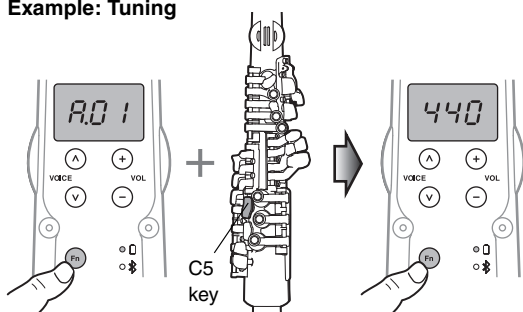

- 2 While holding the [Fn] button, press VOICE [^]/[v] and select the desired value.

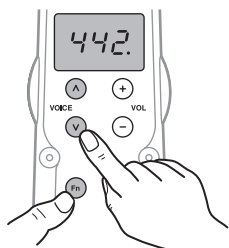

NOTE

- Press both VOICE [^]/[v] buttons simultaneously to restore the value to the factory default.

- 3 When you have finished selecting a value, release the [Fn] button.

This will complete the setting and return the operation to the Voice selection screen.

Function	Settings	Key
Breath pressure resistance Determines how much the sound volume changes in response to the sustained strength of your breath. The lower the value, the more responsive the instrument is to your breath strength.	1 to 5 Default: 3	C3
Breath response Determines how much the sound volume changes in response to your initial breath strength. The higher the value, the harder you have to initially blow into the instrument to produce sound.	1 to 10 Default: 5	Tc
Key response Prevents unwanted sounds from being produced, due to inconsistent timing in fingering when pressing or releasing multiple keys simultaneously. The higher the value, the more unwanted sounds are suppressed.	0 to 20 Default: 10	Ta
Tuning Adjusts the overall pitch of the instrument. The pitch value is displayed on the LED screen. You can adjust the pitch in the range of 427 to 453 Hz in 0.5 Hz steps. The dot in the first digit of the LED display indicates 0.5 Hz.	427 to 453 (Hz) Default: 440	C5
Auto power off Sets the function for automatically turning the power off. The value is displayed on the LED screen.	Off, 5, 10, 15, 30, 60, 120 (minutes) Default: 30	Tf
Bluetooth function on/off Sets the Bluetooth function on or off. When Bluetooth is on and headphones are connected to this instrument, you can listen to music played on a smart device or similar device via Bluetooth.	On, Off Default: Off	Eb
Reverb Set the reverberation effect. The higher the number, the greater the effect. Reverberation is applied only to the headphone output. NOTE <ul style="list-style-type: none"> • Reverberation does not affect the AUX IN input or the audio data received via Bluetooth. 	Off, 1 to 5 Default: Off	G#

• Turning the Bluetooth function on and pairing with your smart device

- 1 Turn the Bluetooth function on.

When it is on, the Bluetooth lamp () will flash slowly. Perform pairing when you want to use Bluetooth Audio.

2 While holding the [Fn] button, press the C key.

This puts the instrument in pairing standby. Keep holding the [Fn] button.

- LED screen: [b--] Pairing standby
- LED screen: [---] Bluetooth function off

3 While holding the [Fn] button, press the VOICE [^] button to begin pairing.

The LED screen will change to the following display and the Bluetooth lamp (📶) will flash rapidly.



NOTE

- To cancel the pairing, press the VOICE [v] button.

4 Select the connection on the smart device.

Select [YDS-150 Audio] if handling audio.

5 When pairing is complete, the Bluetooth lamp will switch from quickly flashing to staying on.

If pairing fails, the Bluetooth lamp flashes slowly and the LED display changes to [b--].

6 If five minutes elapse since starting pairing in Step 3, pairing fails.

7 Release the [Fn] button.

Operation returns to the Voice selection screen.

NOTE

- While paired, the Bluetooth lamp stays lit up.
- Depending on your smart device, audio can play at a high or uncomfortable volume level. Adjust the volume of your smart device before playing audio.

Using the Dedicated App

You can use the dedicated app for this instrument to perform settings for the functions of this instrument more conveniently.

1 Install the dedicated app for this instrument on your smart device.

2 Connect this instrument and your smart device via Bluetooth.

You can perform the following settings for this instrument on the app. For details, refer to the manual for the app.

- Editing user Voices / editing fingering information / enabling and disabling Voice selection shortcuts, etc.

Instrument Maintenance after Playing

Before storing this instrument in its case, remove the mouthpiece from this instrument and wipe off any moisture near the bell and mouthpiece.

1 Loosen the ligature screws and remove the reed and ligature from the mouthpiece.

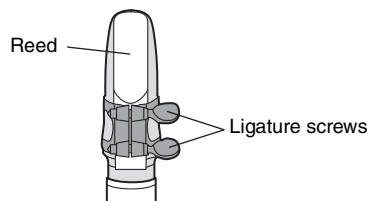

2 Hold the mouthpiece firmly and turn it from side to side to slide it off from the neck.



NOTICE

- When removing the mouthpiece, avoid applying a bending force to the neck base. Excessive force applied to the neck can damage it.

3 Use a cleaning swab (sold separately) to clean the inside of the mouthpiece.

- * Be careful not to damage the tip of the mouthpiece.
- * Always keep the cleaning swab clean and dry.

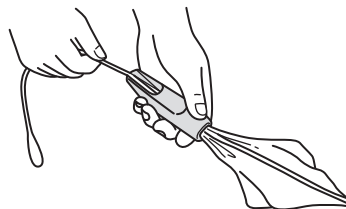

4 Wipe the bell and keys with a dry, soft cloth.

■ Setting the Reed and Ligature

Slide the mouthpiece onto the body's neck, turning from side to side. After attaching the mouthpiece, set the reed and ligature onto the mouthpiece.

NOTICE

- The reed tip is delicate so please take care not to damage it with the ligature, etc.

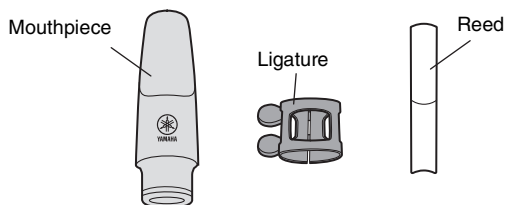

- 1 Slide the ligature onto the mouthpiece from its tapered end.**
- 2 Position the reed so that the edge of the mouthpiece is slightly visible over the reed tip. Tighten the two screws on the ligature to secure the reed in place.**

- * Position the ligature so that the tuning fork logo is centered in the ligature's open space.

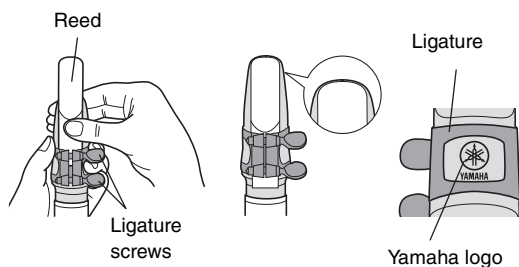

NOTICE

- Use the dedicated mouthpiece set (mouthpiece, reed, ligature) included with this instrument. Failure to do so can result in sound not being produced properly or other malfunctions.
- Tighten the ligature screws just enough to keep the reed from moving. Take care not to over-tighten.
- Do not wash this instrument or the instrument interior with water. Doing so can result in damage to the instrument.
- Do not apply grease to the instrument neck. Doing so can result in damage to the neck.
- When the connection between the neck and the mouthpiece is getting looser, replace the O-ring with the included replacement one.
- If over the course of use the tip of the reed is broken off or the reed becomes disfigured, replace it with the included replacement reed.

Troubleshooting

• Sound does not stop.

- Try turning the power on again.
- Fluid remaining on the hole inside the mouthpiece joint may result in the sound not stopping. Remove fluid from the hole by using a slim cotton swab.

Specifications

Product name	Digital Saxophone
Voices	AWM Sampling
Bluetooth	Bluetooth version: 4.2 Supported profile: A2DP Complies with Bluetooth Low Energy MIDI Specification Wireless output: Bluetooth Class 2 Maximum communication distance: About 10 m Radio frequency (Operation frequency): 2,402 to 2,480 MHz Maximum output power (EIRP): 4 dBm Type of modulation: FHSS
Power supply	USB AC adaptor: 5 V / 1 A Self-powered USB hub: 5 V / 1 A Four "AAA" size alkaline (LR3) or Ni-MH rechargeable (HR3) batteries
Power consumption	4.5 W (when using a USB AC adaptor)
Auto Power Off	Yes
Size (W x D x H)	699 mm (W) x 110 mm (D) x 103 mm (H)
Weight	1.0 kg (not including batteries)

- * The contents of this manual apply to the latest specifications as of the publishing date. To obtain the latest manual, access the Yamaha website then download the manual file.
Since specifications, equipment or separately sold accessories may not be the same in every locale, please check with your Yamaha dealer.

For electrical and electronic products using batteries.

Information for users on collection and disposal of old equipment and used batteries:



These symbols on the products, packaging, and/or accompanying documents mean that used electrical and electronic products and batteries should not be mixed with general household waste.

For proper treatment, recovery and recycling of old products and used batteries, please take them to applicable collection points, in accordance with your national legislation.

By disposing of these products and batteries correctly, you will help to save valuable resources and prevent any potential negative effects on human health and the environment which could otherwise arise from inappropriate waste handling.

For more information about collection and recycling of old products and batteries, please contact your local municipality, your waste disposal service or the point of sale where you purchased the items.



For business users in the European Union:

If you wish to discard electrical and electronic equipment, please contact your dealer or supplier for further information.



Information on Disposal in other Countries outside the European Union:

These symbols are only valid in the European Union. If you wish to discard these items, please contact your local authorities or dealer and ask for the correct method of disposal.

Note for the battery symbol (bottom two symbol examples):

This symbol might be used in combination with a chemical symbol. In this case it complies with the requirement set by the EU Battery Directive for the chemical involved.

Cd

(weee_battery_eu_en_02)

Verbraucherinformation zur Sammlung und Entsorgung alter Elektrogeräte und benutzter Batterien



Befinden sich diese Symbole auf den Produkten, der Verpackung und/oder beiliegenden Unterlagen, so sollten benutzte elektrische Geräte und Batterien nicht mit dem normalen Haushaltsabfall entsorgt werden.

In Übereinstimmung mit Ihren nationalen Bestimmungen bringen Sie alte Geräte und benutzte Batterien bitte zur fachgerechten Entsorgung, Wiederaufbereitung und Wiederverwendung zu den entsprechenden Sammelstellen.

Durch die fachgerechte Entsorgung der Elektrogeräte und Batterien helfen Sie, wertvolle Ressourcen zu schützen, und verhindern mögliche negative Auswirkungen auf die menschliche Gesundheit und die Umwelt, die andernfalls durch unsachgerechte Müllentsorgung auftreten könnten.



Für weitere Informationen zum Sammeln und Wiederaufbereiten alter Elektrogeräte und Batterien kontaktieren Sie bitte Ihre örtliche Stadt- oder Gemeindeverwaltung, Ihren Abfallentsorgungsdienst oder die Verkaufsstelle der Artikel.

Information für geschäftliche Anwender in der Europäischen Union:

Wenn Sie Elektrogeräte ausrangieren möchten, kontaktieren Sie bitte Ihren Händler oder Zulieferer für weitere Informationen.

Entsorgungsinformation für Länder außerhalb der Europäischen Union:

Diese Symbole gelten nur innerhalb der Europäischen Union. Wenn Sie solche Artikel ausrangieren möchten, kontaktieren Sie bitte Ihre örtlichen Behörden oder Ihren Händler und fragen Sie nach der sachgerechten Entsorgungsmethode.



Anmerkung zum Batteriesymbol (untere zwei Symbolbeispiele):

Dieses Symbol kann auch in Kombination mit einem chemischen Symbol verwendet werden. In diesem Fall entspricht dies den Anforderungen der EU-Batterierichtlinie zur Verwendung chemischer Stoffe.

Cd

(weee_battery_eu_de_02)

Informations concernant la collecte et le traitement des piles usagées et des déchets d'équipements électriques et électroniques



Les symboles sur les produits, l'emballage et/ou les documents joints signifient que les produits électriques ou électroniques usagés ainsi que les piles usagées ne doivent pas être mélangés avec les déchets domestiques habituels.

Pour un traitement, une récupération et un recyclage appropriés des déchets d'équipements électriques et électroniques et des piles usagées, veuillez les déposer aux points de collecte prévus à cet effet, conformément à la réglementation nationale.

En vous débarrassant correctement des déchets d'équipements électriques et électroniques et des piles usagées, vous contribuerez à la sauvegarde de précieuses ressources et à la prévention de potentiels effets négatifs sur la santé humaine qui pourraient advenir lors d'un traitement inapproprié des déchets.

Pour plus d'informations à propos de la collecte et du recyclage des déchets d'équipements électriques et électroniques et des piles usagées, veuillez contacter votre municipalité, votre service de traitement des déchets ou le point de vente où vous avez acheté les produits.



Pour les professionnels dans l'Union européenne :

Si vous souhaitez vous débarrasser des déchets d'équipements électriques et électroniques, veuillez contacter votre vendeur ou fournisseur pour plus d'informations.

Informations sur la mise au rebut dans d'autres pays en dehors de l'Union européenne :

Ces symboles sont seulement valables dans l'Union européenne. Si vous souhaitez vous débarrasser de déchets d'équipements électriques et électroniques ou de piles usagées, veuillez contacter les autorités locales ou votre fournisseur et demander la méthode de traitement appropriée.



Note pour le symbole « pile » (deux exemples de symbole ci-dessous) :

Ce symbole peut être utilisé en combinaison avec un symbole chimique. Dans ce cas, il respecte les exigences établies par la directive européenne relative aux piles pour le produit chimique en question.

Cd

(weee_battery_eu_fr_02)

Información para usuarios sobre la recogida y eliminación de los equipos antiguos y las pilas usadas



Estos símbolos en los productos, embalajes y documentos anexos significan que los productos eléctricos y electrónicos y sus pilas no deben mezclarse con los desperdicios domésticos normales.

Para el tratamiento, recuperación y reciclaje apropiados de los productos antiguos y las pilas usadas, llévelos a puntos de reciclaje correspondientes, de acuerdo con la legislación nacional.

Al deshacerse de estos productos y pilas de forma correcta, ayudará a ahorrar recursos valiosos y a impedir los posibles efectos desfavorables en la salud humana y en el entorno que de otro modo se producirían si se trataran los desperdicios de modo inapropiado.

Para obtener más información acerca de la recogida y el reciclaje de los productos antiguos y las pilas, póngase en contacto con las autoridades locales, con el servicio de eliminación de basuras o con el punto de venta donde adquirió los artículos.



Para los usuarios empresariales de la Unión Europea:

Si desea desechar equipos eléctricos y electrónicos, póngase en contacto con su vendedor o proveedor para obtener más información.



Información sobre la eliminación en otros países fuera de la Unión Europea:

Estos símbolos solamente son válidos en la Unión Europea. Si desea desechar estos artículos, póngase en contacto con las autoridades locales o con el vendedor y pregúnteles el método correcto.

Nota sobre el símbolo de pila (dos ejemplos de símbolos en la parte inferior):

Este símbolo se puede utilizar en combinación con un símbolo químico. En este caso, cumple el requisito establecido por la Directiva de la UE sobre pilas correspondiente a la sustancia química utilizada.

Cd

(weee_battery_eu_es_02)

Informações para os utilizadores relativas à recolha e eliminação de baterias e equipamentos usados



Os símbolos ilustrados, presentes em produtos, embalagens e/ou incluídos na documentação associada, indicam que as baterias e os produtos elétricos e eletrónicos usados não devem ser eliminados juntamente com os resíduos domésticos em geral.

O procedimento correto consiste no tratamento, recuperação e reciclagem de produtos e baterias usados, pelo que deve proceder à respetiva entrega nos pontos de recolha adequados, em conformidade com a legislação nacional em vigor.

A eliminação destes produtos e baterias de forma adequada permite poupar recursos valiosos e evitar potenciais efeitos prejudiciais para a saúde pública e para o ambiente, associados ao processamento incorreto dos resíduos.

Para mais informações relativas à recolha e reciclagem de baterias e produtos usados, contacte as autoridades locais, o serviço de eliminação de resíduos ou o ponto de venda onde foram adquiridos os itens relevantes.



Informações para utilizadores empresariais na União Europeia:

Para proceder à eliminação de equipamento elétrico e eletrónico, contacte o seu revendedor ou fornecedor para obter informações adicionais.



Informações relativas à eliminação em países não pertencentes à União Europeia:

Estes símbolos são válidos exclusivamente na União Europeia. Caso pretenda eliminar este tipo de itens, contacte as autoridades locais ou o seu revendedor e informe-se acerca do procedimento correto para proceder à respetiva eliminação.

Nota relativa ao símbolo referente a baterias (os dois exemplos de símbolos na parte inferior):

Este símbolo poderá ser apresentado com um símbolo químico associado. Neste caso, significa que está em conformidade com os requisitos estabelecidos na Diretiva da UE relativa a Baterias no âmbito do elemento químico relacionado.

Cd

(weee_battery_eu_pt_02a)



Important Notice:

U.S. LIMITED WARRANTY for Customers in the United States

For detailed information about this Yamaha product and warranty service, please either visit the following website address (printable file is available at our website) or contact Customer Service at the address or telephone number identified below.

Website Address:

<https://usa.yamaha.com/support/warranty/index.html>

Customer Service:

Yamaha Corporation of America
6600 Orangethorpe Avenue, Buena Park, CA
90620-1273 Telephone: 800-854-1569

音色リスト / Voice List / Voice-Liste / Liste des sonorités / Lista de voces / Lista de voces / Список тембров / 음색 목록 / 音色一览表

Display	Voice Name	Trans-position	Analog Controller
A.01	Alto Sax 1 (Pop)	E♭ (-9)	Pitch Bend
A.02	Alto Sax 2 (Straight)	E♭ (-9)	Pitch Bend
A.03	Alto Sax 3 (Jazzy)	E♭ (-9)	Pitch Bend
A.04	Alto Sax 4 (Ballad)	E♭ (-9)	Pitch Bend
A.05	Alto Sax 5 (Rock)	E♭ (-9)	Pitch Bend
A.06	Alto Sax 6 (Funky)	E♭ (-9)	Pitch Bend
A.07	Alto Sax 7 (Classic)	E♭ (-9)	Pitch Bend
A.08	Alto Sax 8 (Rich Classic)	E♭ (-9)	Pitch Bend
A.09	Alto Sax 9 (Rich Vibrato)	E♭ (-9)	Pitch Bend
A.10	Alto Sax 10 (Modern Classic)	E♭ (-9)	Pitch Bend
A.11	DUAL Alto Sax 1 (Octave Alto and Tenor)	E♭ (-9)	Pitch Bend
A.12	DUAL Alto Sax 2 (4th Alto and Soprano)	E♭ (-9)	Pitch Bend
A.13	DUAL Alto Sax 3 (5th Alto and Tenor)	E♭ (-9)	Pitch Bend
A.14	FX Alto Sax 1 (Distortion Effect)	E♭ (-9)	Pitch Bend
A.15	FX Alto Sax 2 (Overdrive Effect)	E♭ (-9)	Pitch Bend
A.16	FX Alto Sax 3 (Flanger Effect)	E♭ (-9)	Pitch Bend
A.17	FX Alto Sax 4 (Phaser Effect)	E♭ (-9)	Portamento
S.01	Soprano Sax 1 (Pop)	B♭ (-2)	Pitch Bend
S.02	Soprano Sax 2 (Straight)	B♭ (-2)	Pitch Bend
S.03	Soprano Sax 3 (Jazzy)	B♭ (-2)	Pitch Bend
S.04	Soprano Sax 4 (Bright Pop)	B♭ (-2)	Pitch Bend
S.05	Soprano Sax 5 (Classic)	B♭ (-2)	Pitch Bend
S.06	Soprano Sax 6 (Rich Classic)	B♭ (-2)	Pitch Bend
S.07	Soprano Sax 7 (Smooth)	B♭ (-2)	Pitch Bend
S.08	DUAL Soprano Sax 1 (Octave Soprano and Alto)	B♭ (-2)	Pitch Bend
S.09	DUAL Soprano Sax 2 (4th Soprano and Alto)	B♭ (-2)	Pitch Bend
S.10	FX Soprano Sax 1 (Overdrive Effect)	B♭ (-2)	Pitch Bend
S.11	FX Soprano Sax 2 (Overdrive Effect)	B♭ (-2)	Pitch Bend
S.12	FX Soprano Sax 3 (Distortion Effect)	B♭ (-2)	Pitch Bend
S.13	FX Soprano Sax 4 (Phaser Effect)	B♭ (-2)	Portamento
T.01	Tenor Sax 1 (Pop)	B♭ (-14)	Pitch Bend
T.02	Tenor Sax 2 (Straight)	B♭ (-14)	Pitch Bend
T.03	Tenor Sax 3 (Jazzy)	B♭ (-14)	Pitch Bend
T.04	Tenor Sax 4 (Breathy)	B♭ (-14)	Pitch Bend
T.05	Tenor Sax 5 (Rock)	B♭ (-14)	Pitch Bend
T.06	Tenor Sax 6 (Funky)	B♭ (-14)	Pitch Bend
T.07	Tenor Sax 7 (Classic)	B♭ (-14)	Pitch Bend
T.08	Tenor Sax 8 (Rich Classic)	B♭ (-14)	Pitch Bend

Display	Voice Name	Trans-position	Analog Controller
T.09	DUAL Tenor Sax 1 (Octave Tenor and Alto)	B♭ (-14)	Pitch Bend
T.10	DUAL Tenor Sax 2 (Octave Tenor and Baritone)	B♭ (-14)	Pitch Bend
T.11	DUAL Tenor Sax 3 (4th Tenor and Alto)	B♭ (-14)	Pitch Bend
T.12	FX Tenor Sax 1 (Distortion Effect)	B♭ (-14)	Pitch Bend
T.13	FX Tenor Sax 2 (Overdrive Effect)	B♭ (-14)	Pitch Bend
T.14	FX Tenor Sax 3 (Flanger Effect)	B♭ (-14)	Pitch Bend
T.15	FX Tenor Sax 4 (Phaser Effect)	B♭ (-14)	Portamento
B.01	Baritone Sax 1 (Pop)	E♭ (-21)	Pitch Bend
B.02	Baritone Sax 2 (Jazzy)	E♭ (-21)	Pitch Bend
B.03	Baritone Sax 3 (Ballad)	E♭ (-21)	Pitch Bend
B.04	Baritone Sax 4 (Rock)	E♭ (-21)	Pitch Bend
B.05	Baritone Sax 5 (Slap)	E♭ (-21)	Portamento
B.06	DUAL Baritone Sax 1 (Octave Baritone and Tenor)	E♭ (-21)	Pitch Bend
B.07	DUAL Baritone Sax 2 (15th Baritone and Soprano)	E♭ (-21)	Pitch Bend
B.08	DUAL Baritone Sax 3 (5th Baritone and Tenor)	E♭ (-21)	Pitch Bend
B.09	FX Baritone Sax 1 (Distortion Effect)	E♭ (-21)	Pitch Bend
B.10	FX Baritone Sax 2 (Overdrive Effect)	E♭ (-21)	Pitch Bend
B.11	FX Baritone Sax 3 (Phaser Effect)	E♭ (-21)	Portamento
C.01	Harmonica	C (0)	Pitch Bend
C.02	Irish Pipes	C (0)	Pitch Bend
C.03	Pan Pipes	C (0)	Pitch Bend
C.04	Shakuhachi (Japanese Bamboo Flute)	C (0)	Pitch Bend
C.05	Di Zi (Chinese Transverse Flute)	C (+12)	Pitch Bend
C.06	Sawtooth Lead 1	C (0)	Pitch Bend
C.07	Sawtooth Lead 2	C (+12)	Pitch Bend
C.08	Sawtooth Lead 3	C (0)	Pitch Bend
C.09	Sawtooth Lead 4	C (0)	Pitch Bend
C.10	Sawtooth Lead 5	C (0)	Pitch Bend
C.11	Square Lead 1	C (0)	Modulation
C.12	Square Lead 2	C (0)	Pitch Bend
C.13	Square Lead 3	C (+12)	Portamento
C.14	Resonance Lead 1	C (0)	Pitch Bend
C.15	Resonance Lead 2	C (0)	Modulation
C.16	Resonance Lead 3	C (-12)	Portamento
C.17	Sawtooth Bass	C (-24)	Pitch Bend

フィンガリングチャート / Fingering Chart / Griffabelle / Tableau des doigts /



押さえる
Close
Geschlossen
Fermé
Cerrado
Fechado
Закрытый
닫힘
关闭



放す
Open
Offen
Ouvert
Abierto
Aberto
Открытый
열림
开启

この表は代表的な連指を掲載しています。
楽譜は記譜音で表記しています。

This chart shows typical fingerings for saxophones. The music notation is the written pitch, and not the concert pitch.

Diese Karte zeigt die typischen Griffe für Saxophone.
Die Noten entsprechen der notierten Tonhöhe, nicht dem Kamerton.

Low A

Gráfico de digitado / Tabela de digitação / Аппликатура / 운지법 / 指法表

Ce graphique représente les doigtés types pour les saxophones. La partition musicale correspond au diapason écrit et non au diapason de concert.

Este gráfico muestra los digitados habituales en los saxofones. La notación musical es el tono escrito, no el tono de concierto.

Esta tabela mostra as digitações mais comuns para saxofones. A notação musical corresponde à afinação indicada e não à afinação de concerto.

Ниже показана типичная аппликатура для саксофонов. Музыкальная нотация представлена в написанном, а не концертном строе.

이 표는 색소폰의 일반적인 운지법을 나타냅니다. 기보는 콘서트 피치가 아닌, 문서로 작성된 피치입니다.

本指法表上标有萨克斯演奏的典型指法。音符上标示的是谱面音高，而非演奏音高。

The chart displays typical fingering patterns for saxophones across four rows of notes. Each row includes a musical staff with notes and a corresponding diagram of a saxophone key with black dots indicating finger placement. The notes are: Row 1: G, A, B, C, D, E, F; Row 2: F#, G, A, B, C, D, E, F, G; Row 3: G, A, B, C, D, E, F, G, A; Row 4: G, A, B, C, D, E, F.

MEMO

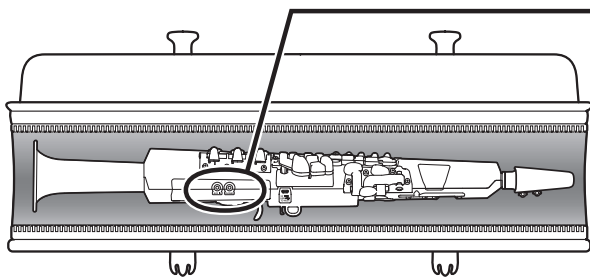

PHONES 端子の孔を真上に向ける。

Make sure the PHONES jack is facing up.

Achten Sie darauf, dass die PHONES-Buchse nach oben zeigt.

Vérifiez que la prise PHONES est sur le haut.

Asegúrese de que la toma PHONES apunte hacia arriba.

O conector PHONES deve estar voltado para cima.

Убедитесь, что разъем PHONES находится сверху.

PHONES 잭이 위로 향하도록 하십시오.

请确认PHONES插孔正面朝上。

ご注意

- 楽器本体をケースに収納するときは、製品本体のPHONES 端子の孔を真上に向けて収納してください。それ以外の向きで収納すると、キイが故障するおそれがあります。

NOTICE

- Make sure that the PHONES jack is facing up when storing the instrument in the case. Failing to do so can cause damage to the keys.

ACHTUNG

- Achten Sie darauf, dass die PHONES-Buchse nach oben zeigt, wenn Sie das Instrument in den Koffer legen. Andernfalls können die Klappen beschädigt werden.

AVIS

- Vérifiez que la prise PHONES est sur le haut lorsque vous rangez l'instrument dans son étui. Sinon, vous risqueriez d'endommager les clés.

AVISO

- Al guardar el instrumento en el estuche, asegúrese de que la toma PHONES apunte hacia arriba. De no hacerlo así, podría dañar las llaves.

AVISO

- Verifique se o conector PHONES está voltado para cima ao guardar o instrumento na caixa. Caso contrário, as teclas poderão ser danificadas.

УВЕДОМЛЕНИЕ

- Убирая инструмент в футляр, убедитесь, что разъем PHONES находится сверху. Несоблюдение этого правила может привести к повреждению клавиш.

주의사항

- 악기를 케이스에 보관할 때는 PHONES 잭이 위로 향하도록 하십시오. 그렇지 않으면 키가 손상될 수 있습니다.

须知

- 将乐器放入乐器盒储存之前，请确认PHONES插孔正面朝上。否则可能损坏按键。

雅马哈乐器音响（中国）投资有限公司

上海市静安区新闻路1818号云和大厦2楼

客户服务热线：4000517700

公司网址：<http://www.yamaha.com.cn>

制造商：雅马哈株式会社

制造商地址：日本静冈县滨松市中区中泽町10-1

进口商：雅马哈乐器音响（中国）投资有限公司

进口商地址：上海市静安区新闻路1818号云和大厦2楼

原产地：印度尼西亚

Manual Development Group

©2020 Yamaha Corporation

Published 07/2020

2020年7月发行

POE1-B0

VDH5520