

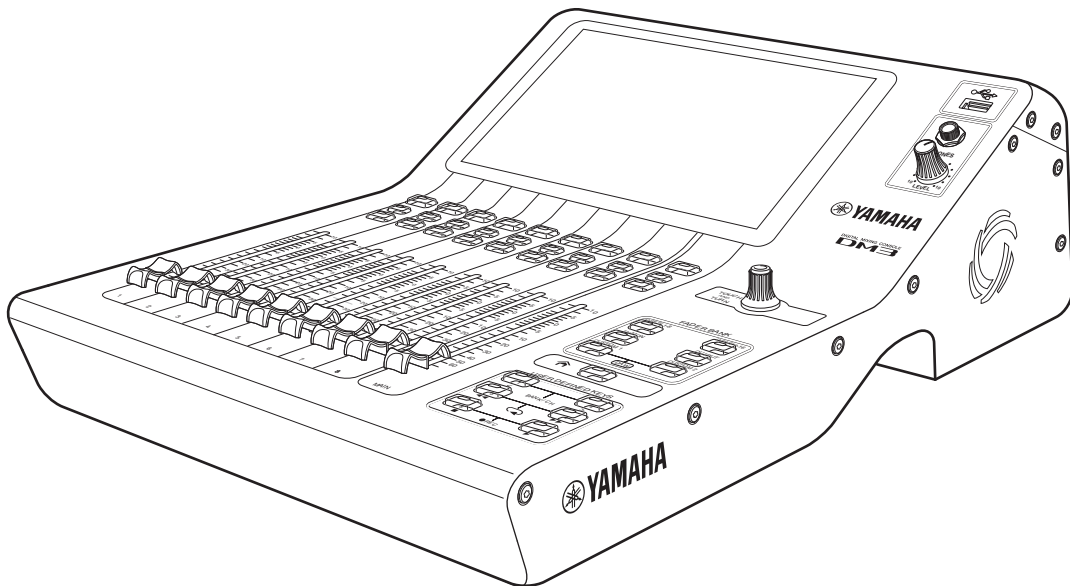



DIGITAL MIXING CONSOLE

DM3 DM3 STANDARD (DM3S)



Owner's Manual

	CAUTION RISK OF ELECTRIC SHOCK DO NOT OPEN	
CAUTION : TO REDUCE THE RISK OF ELECTRIC SHOCK, DO NOT REMOVE COVER (OR BACK). NO USER-SERVICEABLE PARTS INSIDE. REFER SERVICING TO QUALIFIED SERVICE PERSONNEL.		

Explanation of Graphical Symbols



The lightning flash with arrowhead symbol within an equilateral triangle is intended to alert the user to the presence of uninsulated "dangerous voltage" within the product's enclosure that may be of sufficient magnitude to constitute a risk of electric shock to persons.



The exclamation point within an equilateral triangle is intended to alert the user to the presence of important operating and maintenance (servicing) instructions in the literature accompanying the product.

IMPORTANT SAFETY INSTRUCTIONS

1. Read these instructions.
2. Keep these instructions.
3. Heed all warnings.
4. Follow all instructions.
5. Do not use this apparatus near water.
6. Clean only with dry cloth.
7. Do not block any ventilation openings. Install in accordance with the manufacturer's instructions.
8. Do not install near any heat sources such as radiators, heat registers, stoves, or other apparatus (including amplifiers) that produce heat.
9. Do not defeat the safety purpose of the polarized or grounding type plug. A polarized plug has two blades with one wider than the other. A grounding type plug has two blades and a third grounding prong. The wide blade or the third prong are provided for your safety. If the provided plug does not fit into your outlet, consult an electrician for replacement of the obsolete outlet.
10. Protect the power cord from being walked on or pinched particularly at plugs, convenience receptacles, and the point where they exit from the apparatus.
11. Only use attachments/accessories specified by the manufacturer.
12. Use only with the cart, stand, tripod, bracket, or table specified by the manufacturer, or sold with the apparatus. When a cart is used, use caution when moving the cart/apparatus combination to avoid injury from tip-over.
13. Unplug this apparatus during lightning storms or when unused for long periods of time.
14. Refer all servicing to qualified service personnel. Servicing is required when the apparatus has been damaged in any way, such as power-supply cord or plug is damaged, liquid has been spilled or objects have fallen into the apparatus, the apparatus has been exposed to rain or moisture, does not operate normally, or has been dropped.



WARNING
TO REDUCE THE RISK OF FIRE OR ELECTRIC SHOCK, DO NOT EXPOSE THIS APPARATUS TO RAIN OR MOISTURE.



(0502 UL60065_03)

The model number, serial number, power requirements, etc., may be found on or near the name plate, which is at the rear of the unit. You should note this serial number in the space provided below and retain this manual as a permanent record of your purchase to aid identification in the event of theft.

Model No.

Serial No.

(rear_en_02)

	ATTENTION RISQUE DE CHOC ELECTRIQUE-NE PAS OUVRIR	
ATTENTION : POUR RÉDUIRE LES RISQUES D'ÉLECTROCUTION, NE PAS RETIRER LE CAPOT (OU LE DOS). NE CONTIENT PAS DE PIÈCES NÉCESSITANT L'INTERVENTION DE L'UTILISATEUR. POUR TOUTE INTERVENTION, FAIRE APPEL À DES PROFESSIONNELS QUALIFIÉS.		

Explication des symboles



L'éclair avec une flèche à l'intérieur d'un triangle équilatéral est destiné à attirer l'attention de l'utilisateur sur la présence d'une « tension dangereuse » non isolée à l'intérieur de l'appareil, pouvant être suffisamment élevée pour constituer un risque d'électrocution.



Le point d'exclamation à l'intérieur d'un triangle équilatéral est destiné à attirer l'attention de l'utilisateur sur la présence d'instructions importantes sur l'emploi ou la maintenance (réparation) de l'appareil dans la documentation fournie.

PRÉCAUTIONS CONCERNANT LA SÉCURITÉ

1. Lire ces instructions.
2. Conserver ces instructions.
3. Tenir compte de tous les avertissements.
4. Suivre toutes les instructions.
5. Ne pas utiliser ce produit à proximité d'eau.
6. Nettoyer uniquement avec un chiffon propre et sec.
7. Ne pas bloquer les orifices de ventilation. Installer l'appareil conformément aux instructions du fabricant.
8. Ne pas installer l'appareil à proximité d'une source de chaleur comme un radiateur, une bouche de chaleur, un poêle ou tout autre appareil (y compris un amplificateur) produisant de la chaleur.
9. Ne pas modifier le système de sécurité de la fiche polarisée ou de la fiche de terre. Une fiche polarisée dispose de deux broches dont une est plus large que l'autre. Une fiche de terre dispose de deux broches et d'une troisième pour le raccordement à la terre. Cette broche plus large ou cette troisième broche est destinée à assurer la sécurité de l'utilisateur. Si la fiche équipant l'appareil n'est pas compatible avec les prises de courant disponibles, faire remplacer les prises par un électricien.
10. Acheminer les cordons d'alimentation de sorte qu'ils ne soient pas piétinés ni coincés, en faisant tout spécialement attention aux fiches, prises de courant et au point de sortie de l'appareil.
11. Utiliser exclusivement les fixations et accessoires spécifiés par le fabricant.
12. Utiliser exclusivement le chariot, le stand, le trépied, le support ou la table recommandés par le fabricant ou vendus avec cet appareil. Si l'appareil est posé sur un chariot, déplacer le chariot avec précaution pour éviter tout risque de chute et de blessure.
13. Débrancher l'appareil en cas d'orage ou lorsqu'il doit rester hors service pendant une période prolongée.
14. Confier toute réparation à un personnel qualifié. Faire réparer l'appareil s'il a subi tout dommage, par exemple si la fiche ou le cordon d'alimentation est endommagé, si du liquide a coulé ou des objets sont tombés à l'intérieur de l'appareil, si l'appareil a été exposé à la pluie ou à de l'humidité, si l'appareil ne fonctionne pas normalement ou est tombé.



AVERTISSEMENT
POUR RÉDUIRE LES RISQUES D'INCENDIE OU DE DÉCHARGE ÉLECTRIQUE, N'EXPOSEZ PAS CET APPAREIL À LA PLUIE OU À L'HUMIDITÉ.

(0503 UL60065_03)

PRECAUTIONS

PLEASE READ CAREFULLY BEFORE PROCEEDING

Please keep this manual in a safe place for future reference.



WARNING

Always follow the basic precautions listed below to avoid the possibility of serious injury or even death from electrical shock, short-circuiting, damages, fire or other hazards. These precautions include, but are not limited to, the following:

If you notice any abnormality

- If any of the following problems occur, immediately turn off the power switch and disconnect the electric plug from the outlet.
 - The power cord or plug becomes frayed or damaged.
 - Unusual smells or smoke are emitted.
 - Some object, or water has been dropped into the product.
 - There is a sudden loss of sound during use of the product.
 - Cracks or other visible damage appear on the product.
Then have the product inspected or repaired by qualified Yamaha service personnel.

Power supply

- Do not place the power cord near heat sources such as heaters or radiators, and do not excessively bend or otherwise damage the cord, place heavy objects on it, or place it in a position where anyone could walk on, trip over, or roll anything over it.
- Only use the voltage specified as correct for the product. The required voltage is printed on the name plate of the product.
- Use the specified adaptor only. Using the wrong adaptor can result in damage to the product or overheating.
- Use only the supplied power cord/plug. If you intend to use the product in an area other than in the one you purchased, the included power cord may not be compatible. Please check with your Yamaha dealer.
- Check the electric plug periodically and remove any dirt or dust which may have accumulated on it.
- Make sure to fully insert the electric plug to prevent electric shocks or fire.
- When setting up the product, make sure that the AC outlet you are using is easily accessible.
If some trouble or malfunction occurs, immediately turn off the power switch and disconnect the plug from the outlet. Even when the power switch is turned off, as long as the power cord is not unplugged from the wall AC outlet, the product will not be disconnected from the power source.
- Remove the electric plug from the outlet when the product is not to be used for extended periods of time.
- Do not touch the product or the electric plug during an electrical storm.

Connections

- Always read the manuals of the devices to be connected and follow the directions they contain. Failure to do so may result in fire, overheating, explosion, or malfunction.

Do not open

- This product contains no user-serviceable parts.
Do not attempt to disassemble the internal parts or modify them in any way.

Water warning

- Do not expose the product to rain, use it near water or in damp or wet conditions, or place on it any containers (such as vases, bottles or glasses) containing liquids which might spill into any openings.
- Never insert or remove an electric plug with wet hands.

Fire warning

- Do not place any burning items or open flames near the product, since they may cause a fire.

Hearing loss

- Before turning the power of all devices on or off, make sure that all volume levels are set to the minimum.
Failing to do so may result in hearing loss, electric shock, or device damage.
- When turning on the AC power in your audio system, always turn on the power amplifier LAST, to avoid hearing loss and speaker damage. When turning the power off, the power amplifier should be turned off FIRST for the same reason.
- Do not use headphones for a long period of time at a high or uncomfortable volume level, since this can cause permanent hearing loss. If you experience any hearing loss or ringing in the ears, consult a physician.



CAUTION

Always follow the basic precautions listed below to avoid the possibility of physical injury to you or others. These precautions include, but are not limited to, the following:

Power supply

- Do not cover or wrap the AC adaptor with a cloth or blanket.
- When removing the electric plug from the product or an outlet, always hold the plug itself and not the cord. Pulling by the cord can damage it.

Location and connection

- Do not place the product in an unstable position or a location with excessive vibration, where it might accidentally fall over and cause injury.

- Keep this product out of reach of children, to keep them from putting their fingers into openings on the product and accidentally being injured.

This product is not suitable for use in locations where children are likely to be present.

- Do not block the vents. In particular, do not place the product on its side or upside down. Inadequate ventilation can result in overheating, possibly causing damage to the product(s), or even fire.

This product has ventilation holes at the following locations to prevent the internal temperature from becoming too high. Side panel, Rear panel.

- To ensure proper heat dissipation of the product, when installing it:
 - Do not cover it with any cloth.
 - Do not install it on a carpet or rug.
 - Make sure the top surface faces up; do not install on its sides or upside down.

- Do not use the product in a confined, poorly-ventilated location.

Inadequate ventilation can result in overheating, possibly causing damage to the product(s), or even fire.

- If the product is mounted in an EIA standard rack, carefully read the section "Precautions for Rack Mounting". Inadequate ventilation can result in overheating, possibly causing damage to the product(s), malfunction, or even fire. If this product is to be used in a small space other than an EIA-standard rack, make sure that there is adequate space around the product:
 - at least 6 cm at the sides and 12 cm behind.
- Do not place the product in a location where it may come into contact with corrosive gases or salt air. Doing so may result in malfunction.
- Before moving the product, remove all connected cables.

Maintenance

- Remove the power plug from the AC outlet when cleaning the product.

Handling caution

- Do not insert your fingers or hands in any gaps or openings on the product.
- Do not rest your weight on the product or place heavy objects on it.

NOTICE

To avoid the possibility of malfunction/damage to the product, or damage to other property, follow the notices below.

Handling and maintenance

- Do not connect this product to a public Wi-Fi and/or Internet service directly. Only connect this product to the Internet through a router with strong password protections. Consult your router manufacturer for information on optimum security practices.
- Do not use the product in the vicinity of a TV, radio, or other electric products. Otherwise, the product, TV, or radio may generate noise.
- Do not expose the product to excessive dust or vibration, or extreme cold or heat, in order to prevent the possibility of panel disfiguration, unstable operation, or damage to the internal components.
- Do not install in locations where temperature changes are severe. Otherwise, condensation may form on the inside or the surface of the product, causing it to break.
- If there is reason to believe that condensation might have occurred, leave the product for several hours without turning on the power until the condensation has completely dried out, in order to prevent possible damage.
- Do not place vinyl, plastic or rubber objects on the product, since this might cause alteration or discoloration of the panel.
- To avoid generating unwanted noise, make sure there is adequate distance between the AC adaptor and the product.
- When cleaning the product, use a dry and soft cloth. Do not use paint thinners, solvents, cleaning fluids, or chemical-impregnated wiping cloths, since this might cause alteration or discoloration.
- Do not apply oil, grease, or contact cleaner to the faders. Doing so might cause problems with electrical contact or fader motion.

Saving data

- When changing the battery for the clock, please contact the Yamaha service personnel. This product has a built-in battery for the clock, so even when the power supply is interrupted, it maintains the time data of the internal clock. When the clock battery wears out the time data is lost, resulting in time-related data, such as for scenes, saved in the product, to be lost. The expected life of the clock battery is 5 years, but may vary with the usage environment.
- To protect against data loss through media damage, we recommend that you save your important data onto two USB storage devices/external media.

Information

About copyrights

- Copying of the software or reproduction of this manual in whole or in part by any means is expressly forbidden without the written consent of the manufacturer.

About functions/data bundled with the product

- Even when the power switch is in standby status, electricity is still flowing to the product at the minimum level. When you are not using the product for a long time, make sure you unplug the power cord from the wall AC outlet.
- (DM3 only) This product uses the Dante module provided by Audinate. The Dante module used in this product can be confirmed in Dante Controller. For more information about the open source licenses used for each Dante module, please visit Audinate's website.
<https://www.audinate.com/software-licensing>
- The open source license used with this product can be checked on the ABOUT screen of the main unit.
- DynaFont is a registered trademark of DynaComware Taiwan Inc.
- XLR-type connectors are wired as follows (IEC60268 standard): pin 1: ground, pin 2: hot (+), and pin 3: cold (-).

About this manual

- The illustrations and screens as shown in this manual are for instructional purposes only.
- Steinberg Media Technologies GmbH and Yamaha Corporation make no representations or warranties with regard to the use of the software and documentation and cannot be held responsible for the results of the use of this manual and the software.
- Windows is a registered trademark of Microsoft(R) Corporation in the United States and other countries.
- Apple, Mac, iPad, iPhone, and Lightning are trademarks of Apple Inc., registered in the U.S. and other countries.
- IOS is a trademark or registered trademark of Cisco in the U.S. and other countries and is used under license.
- The company names and product names in this manual are the trademarks or registered trademarks of their respective companies.
- Software may be revised and updated without prior notice.

About disposal

- This product contains recyclable components. When disposing of this product, please contact the appropriate local authorities.

Other informations

Yamaha cannot be held responsible for damage caused by improper use or modifications to the product, or data that is lost or destroyed.



Yamaha Eco-Label

Yamaha Eco-Label is a mark that certifies products of high environmental performance.

FCC INFORMATION (U.S.A.)

1. **IMPORTANT NOTICE: DO NOT MODIFY THIS UNIT!**

This product, when installed as indicated in the instructions contained in this manual, meets FCC requirements. Modifications not expressly approved by Yamaha may void your authority, granted by the FCC, to use the product.

2. **IMPORTANT:** When connecting this product to accessories and/ or another product use only high quality shielded cables. Cable/s supplied with this product **MUST** be used. Follow all installation instructions. Failure to follow instructions could void your FCC authorization to use this product in the USA.

3. **NOTE:** This product has been tested and found to comply with the requirements listed in FCC Regulations, Part 15 for Class "B" digital devices. Compliance with these requirements provides a reasonable level of assurance that your use of this product in a residential environment will not result in harmful interference with other electronic devices. This equipment generates/uses radio frequencies and, if not installed and used according to the instructions found in the users manual, may cause interference harmful to the operation of other electronic devices. Compliance with FCC regulations does not guarantee that interference will not occur in all installations. If this product is found to be the source of interference, which can be determined by turning the unit "OFF" and "ON", please try to eliminate the problem by using one of the following measures: Relocate either this product or the device that is being affected by the interference. Utilize power outlets that are on different branch (circuit breaker or fuse) circuits or install AC line filter/s. In the case of radio or TV interference, relocate/reorient the antenna. If the antenna lead-in is 300 ohm ribbon lead, change the lead-in to co-axial type cable. If these corrective measures do not produce satisfactory results, please contact the local retailer authorized to distribute this type of product. If you can not locate the appropriate retailer, please contact Yamaha Corporation of America, Electronic Service Division, 6600 Orangethorpe Ave, Buena Park, CA90620 The above statements apply **ONLY** to those products distributed by Yamaha Corporation of America or its subsidiaries.

(0529-M04 FCC class B)

- This applies only to products distributed by Yamaha Corporation of America.

COMPLIANCE INFORMATION STATEMENT (Supplier's declaration of conformity procedure)

Responsible Party : Yamaha Corporation of America
Address : 6600 Orangethorpe Ave., Buena Park, Calif. 90620
Telephone : 714-522-9011
Type of Equipment : Digital Mixing Console
Model Name : DM3, DM3 STANDARD

This device complies with Part 15 of the FCC Rules.

Operation is subject to the following two conditions:

- 1) this device may not cause harmful interference, and
- 2) this device must accept any interference received including interference that may cause undesired operation.

(0529-M02 FCC sDoc)

- This applies only to products distributed by Yamaha Corporation of America.

This product contains a battery that contains perchlorate material.
Perchlorate Material—special handling may apply.
See www.dtsc.ca.gov/hazardouswaste/perchlorate.

(0583 Perchlorate)

- This applies only to products distributed by Yamaha Corporation of America.

TABLE OF CONTENTS

Introduction	8
Differences among the DM3 Series	8
Intended User	8
Intended Usage	8
Accessories	8
Manual Structure	8
Utility Software	9
Firmware Updates	9
Notation Conventions used in the Owner's Manual	9
Controls and functions	10
Top Panel	10
Rear Panel	11
Side Panel	12
Using the Display	13
Using the Display	13
Switching between Screens	13
Scrolling	13
Operating the Q of EQ	13
Operating Parameters with the [TOUCH AND TURN] Knob	14
Setting the Internal Clock	14
Returning to Factory Settings (Initialization)	15
Rack Mount Kit Installation (Sold separately: RK-DM3)	15
Appendix	16
General Specifications	16
Dimensions	16
Source code distribution	17

Introduction

Thank you very much for your purchase of the Yamaha DM3, DM3 STANDARD. To get the most out of the various functions of the product, be sure to read the owner's manual prior to using it. Afterwards, please keep it in a safe place.

Differences among the DM3 Series

The DM3 can be used with a Dante audio network, but DM3 STANDARD cannot.

Note

Unless otherwise specified, the illustrations are of using the DM3.

Intended User

This product is aimed at people who can operate a mixer in a PA system for halls or events.

Intended Usage

This product is designed for mixing multiple audio sources, such as for live band performances, corporate events or music production.

Accessories

- Owner's Manual (This Manual)
- Power Adaptor (PA-L500)
- DOWNLOAD INFORMATION

Manual Structure

DM3 Series manuals can be downloaded as a PDF from the Yamaha Audio website. The manuals can also be viewed in the HTML format.

<https://www.yamahaproaudio.com/>

Owner's Manual (This Manual)

The manual primarily explains the basic functions and the names of parts on the panel.

DM3 Series Reference Manual

The manual primarily explains functions in detail and corresponding operations. It also explains how to use the software (DM3 Editor) to set up and operate the unit on a computer.

<https://manual.yamaha.com/pa/mixers/dm3/rm/>



DM3 Editor Installation Guide

The guide explains the steps for installing DM3 Editor.

<https://manual.yamaha.com/pa/mixers/dm3/ig/>



DM3 StageMix User Guide

The User Guide explains the iPad application for wirelessly controlling a DM3 Series.

<https://manual.yamaha.com/pa/mixers/dm3/ug/>



Using the HTML Manual

The HTML format manual can be viewed on a computer, tablet, or smartphone via its browser. Use the HTML manual to get an overview of information and quickly find the desired information.

Utility Software

A variety of utility software is available for the DM3 Series. Detailed information about software can be found on the Yamaha Audio website.

<https://www.yamahaproaudio.com/>

Please refer to the website above and installation guides of downloaded programs for how to download, install and make advanced settings to software.

DM3 Editor

This software is for setting up and operating the unit on a computer. It can also backup unit settings and perform setup in locations without the main unit.

DM3 StageMix

This is an iPad application for wirelessly controlling the DM3 Series system. It allows mixing engineers to manipulate mixing parameters directly, such as positioning of performers onstage, while away from the system.

MonitorMix

This software was designed for smart devices to wirelessly control MIX sending of the DM3 Series.

Yamaha Steinberg USB Driver

This is driver software for connecting a DM3 Series with a computer. It allows up to 18IN/18OUT audio signals to be exchanged with DAW software and to remotely control the DAW software.

Firmware Updates

The specification of the DM3 Series allows the firmware of the main unit to be updated for improved operability, added functions and to correct problems.

Information on updating the firmware can be found on the following site.

<https://www.yamahaproaudio.com/>

For information on the updating procedure and making settings for the main unit, refer to the Firmware Updating Guide on the website.

Notation Conventions used in the Owner's Manual

This manual calls switches on the panel "keys." Controls on the panel are written inside brackets [] to distinguish them from virtual buttons and knobs displayed onscreen.

(Example: [CUE] Key) The section name may be written in front of the brackets for some controls. (Example: USER DEFINED KEYS [1] Key)

Controls and functions

Top Panel

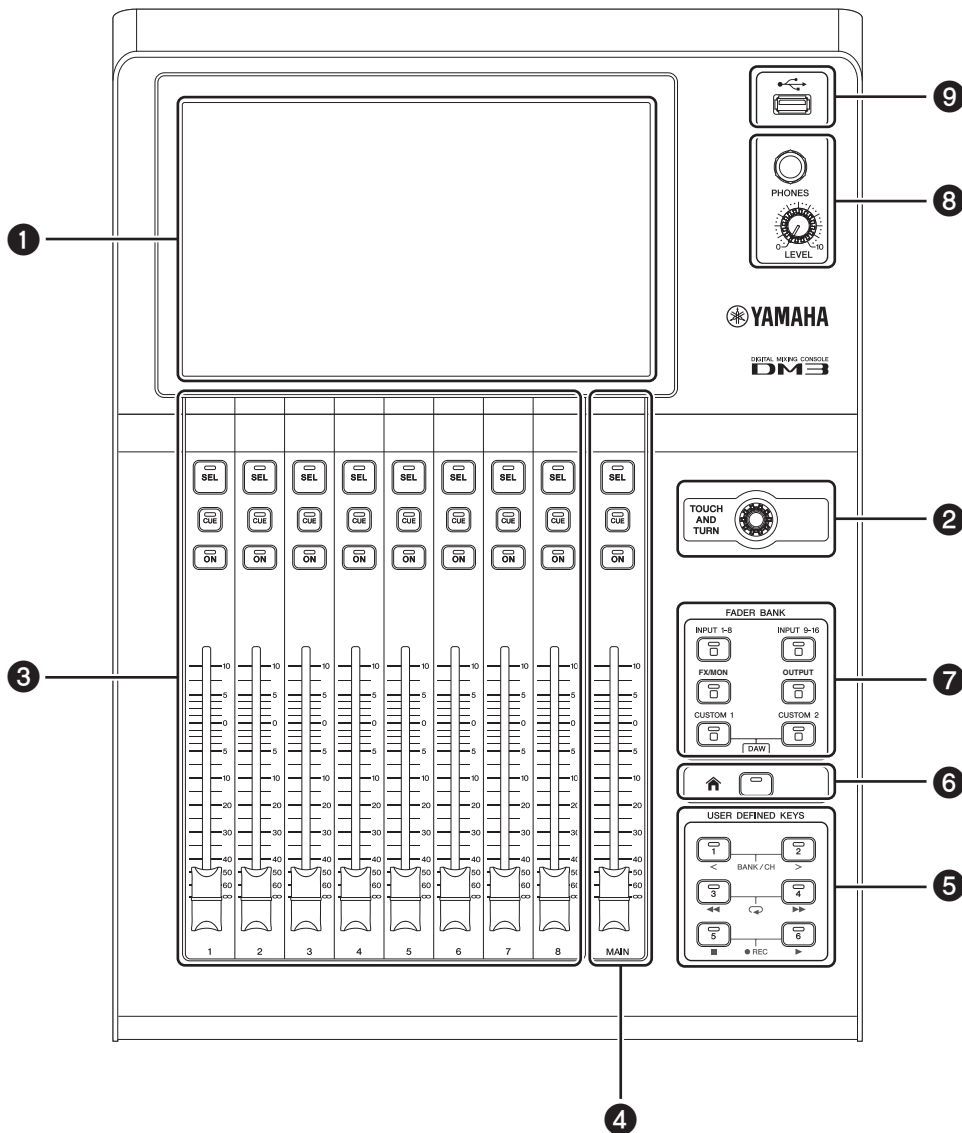

1 Display

The display is operated by directly touching the screen.

2 [TOUCH AND TURN] Knob

Used when adjusting the selected parameter(s).

3 Channel Strip Section

This part corresponds to the channel module in a traditional analog mixer. It operates the main parameters of the currently selected channel.

4 [MAIN] Section

This section is primarily for operating STEREO channel parameters.

5 [USER DEFINED KEYS] Section

These keys are for operating functions assigned by the user according to his/her needs. Some commonly used functions, such as tap tempo and bookmarks, are assigned as defaults.

6 [HOME] Key

This key returns to the HOME screen.

7 [FADER BANK] Section

Switches the allocation of faders on the panel.

8 [PHONES] Section

For monitoring the signal selected with MONITOR select, or the CUE signal, via headphones.

9 USB Connector

This connector is for connecting to USB memory.

Rear Panel

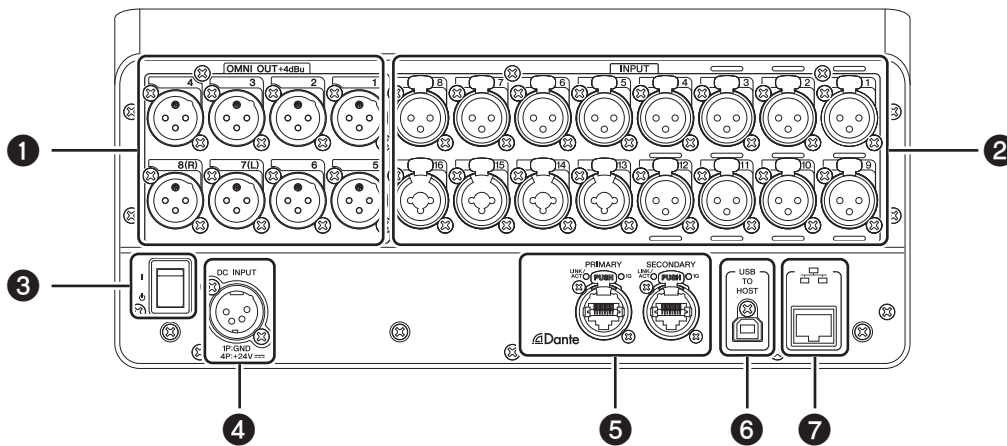

1 [OMNI OUT] Jacks

Has XLR-3-32 type output jacks for outputting analog audio signals. These jacks are primarily for outputting MIX channels and STEREO channels.

2 [INPUT] Jacks

For connecting to mikes and musical instruments.

1 to 12: XLR-3-31 type input jacks

13 to 16: Combo jacks compatible with both XLR-type and TRS phone plugs.

3 Power Switch

In position (I), the power switch is ON.

In position (O), the power switch is on standby.

NOTICE

- The power switch goes to standby at least 10 seconds after the last operation. The product saves the state immediately before going into standby, and reproduces it when the power is back on.
- Let at least 6 seconds elapse after the power switch goes into standby before turning it back ON. Constantly turning the power switch ON/OFF may result in malfunction.

4 [DC INPUT] Connector

For connecting to the included power adaptor. First connect the product to the power adaptor and then insert the power plug into the outlet.



WARNING

Only ever use the included cord as the power cord. Also, never use the included power cord for another product. Doing so may result in failure, overheating and/or fire.



CAUTION

- Always put the power switch on standby before connecting or disconnecting the power cord.
- A small amount of power flows even when the power is OFF (on standby). When the product will not be used for a long time, always unplug the power cord from the outlet.

5 Dante PRIMARY/SECONDARY Connectors (DM3 only)

These connectors are for Dante audio network connections, such as for I/O devices like the Tio1608-D. Use RJ-45 connectors that are compatible with Neutrik etherCON CAT5e.

NOTICE

To prevent electromagnetic interference, use an STP (Shielded Twisted Pair) cable. Make sure that the metal parts of the plugs are electrically connected to the STP cable shield by conductive tape or comparable means.

NOTE

Do not use a network switching EEE function (*) within the Dante network.

The interactive power saving settings between switches compatible with the EEE function are adjusted automatically, but the interactive setting fails to adjust properly with some switches.

As a result, the EEE function may be enabled in inappropriate points in the Dante network, which can lead to poor clock synchronization and choppy audio. So pay attention to the following points.

- If using a managed switch, turn OFF the EEE function of all ports that use Dante. Do not use switches whose EEE function cannot be turned OFF.
- Do not use switches compatible with the EEE function when using a managed switch. The EEE function of these switches cannot be turned OFF.

*EEE (Energy Efficient Ethernet) function: This technology reduces energy consumption of Internet devices when network traffic is light. It is also called "green ethernet" or IEEE802.3az.

6 [USB TO HOST] Connector

USB Type B Connector

The product functions as an up to 18 IN/18 OUT, 96 kHz/32 bit audio interface by connecting to a computer via USB cables. It also allows control of DM3 series and remote control of DAW software by USB-MIDI.

Installing Yamaha Steinberg USB Driver is required for communication with a computer.

NOTICE
<ul style="list-style-type: none"> • Use USB cables less than 3 meters long. • Leave an interval of at least 6 seconds between plugging/unplugging the USB cable.

7 Network Connector

This is an RJ-45 connector for connector to a computer. Use an ethernet cable (CAT5e or better recommended).

NOTICE
To prevent electromagnetic interference, use an STP (Shielded Twisted Pair) cable.

Side Panel

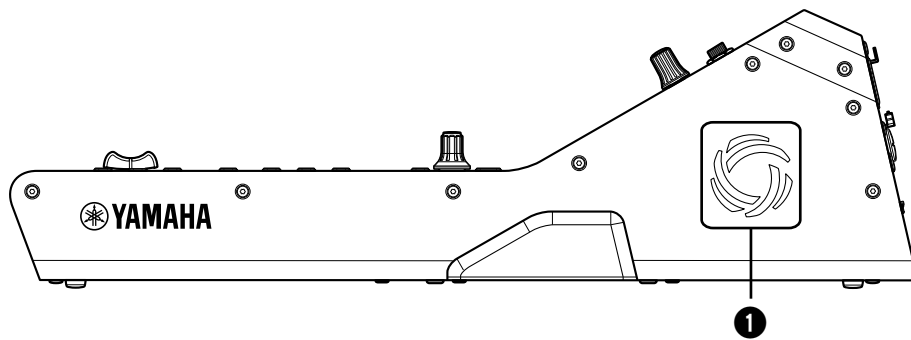

1 Ventilation Ports

This port is equipped with a cooling fan to prevent the inside from getting too hot. When it gets too hot inside, the fan starts automatically.

There are ventilation ports on both the left and right sides.

 CAUTION
Do not block the ventilation ports (heat dissipating slits) of this product. If ventilation ports are covered, heat gets trapped inside the product, which may result in malfunction and/or fire.

Using the Display

Using the Display

The display is operated by directly touching the screen. The [TOUCH AND TURN] knob can also be used for making fine adjustments of parameters.

It can be operated via touch/double-touch, as well as sliding, swiping and pinching in/out.

Switching between Screens

Touching a box on the screen switches it to that related screen.

Press the [HOME] key  to return to the HOME screen.

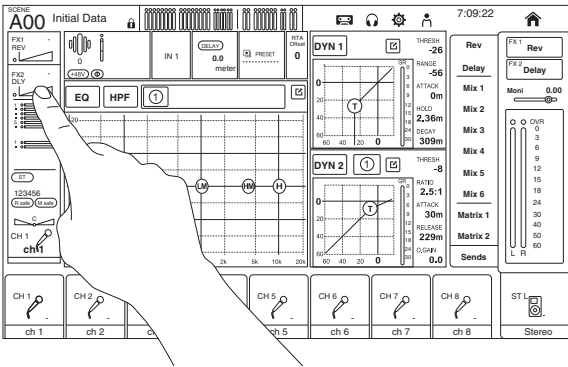

NOTE

What is displayed on the HOME screen can be selected via the Key Function → [HOME] key on the SETUP screen → PREFERENCE screen. If multiple items are selected, the display switches each time the [HOME] key  is pressed.

SELECTED CHANNEL Section

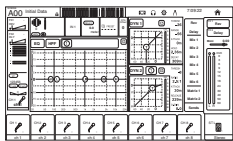

CH STRIP Section

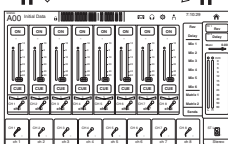
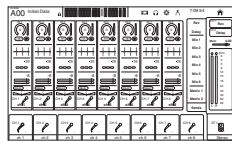

FADER Section

Scrolling

On screens with scroll bars, sliding the screen up/down or left/right opens the next screen.

Swiping it allows you to scroll quickly.

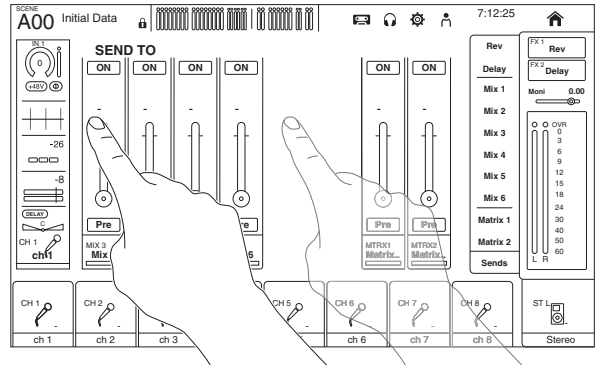

Operating the Q of EQ

When in the manual mode and a handle is selected, pinching it in/out on the EQ screen allows Q operation of the selected handle.

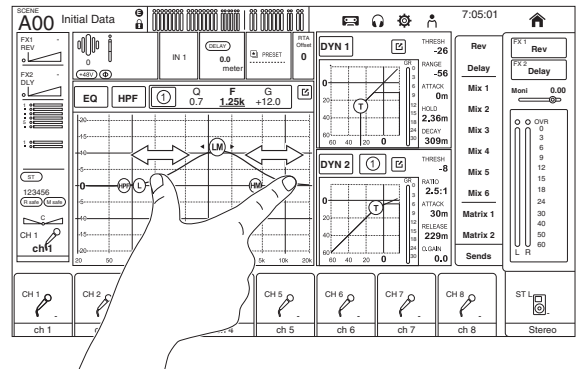

NOTE

This method of operation is not available when in the 1-knob mode, which allows multiple parameters to be operated with one knob. Select manual mode with the mode switching button at the top of the screen.

Operating Parameters with the [TOUCH AND TURN] Knob

As shown in the following figure, touch the desired parameter to select it (1) and then operate it with the [TOUCH AND TURN] knob (2). A pink frame appears on the selected parameter.

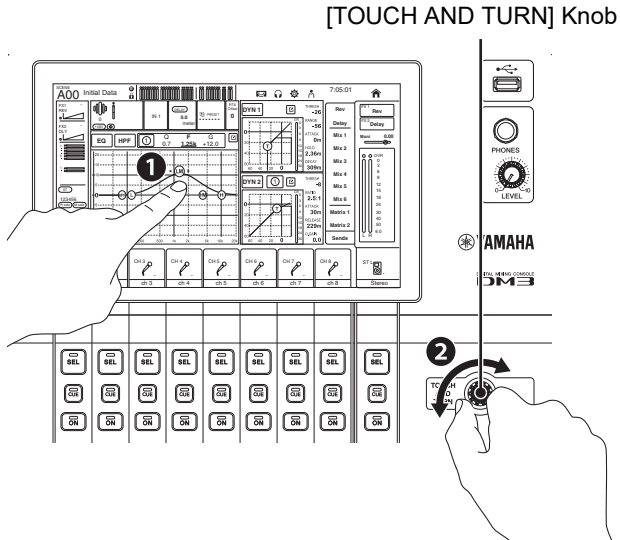

NOTE

1-knob Mode

1-knob mode allows you to control multiple EQ or compressor parameters by simply turning the [TOUCH AND TURN] knob. When 1-knob mode is enabled, parameters cannot be adjusted individually. You can turn 1-knob mode on and off from the EQ and compressor screens.

Setting the Internal Clock

The method for making time and date settings for the internal clock of the DM Series and the display method for date and time are explained below. The date and time settings made here will affect the time stamp when scenes are saved.

1 Touch the SETUP button .

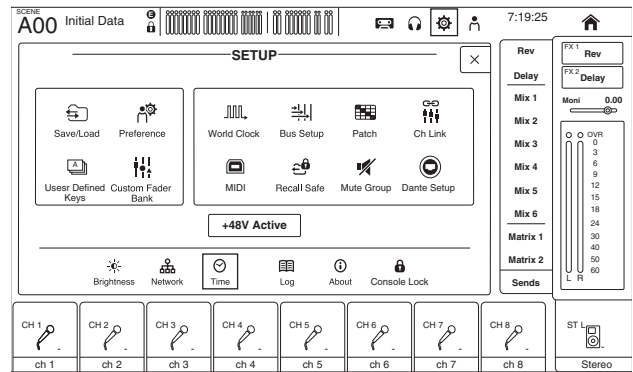

2 Touch the TIME button.

The screen for setting the date and time opens.

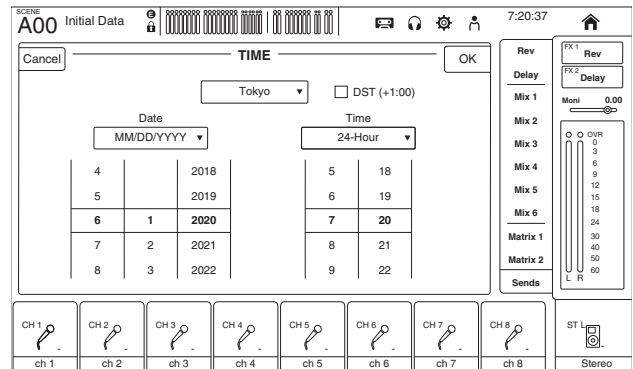

3 Slide the date and/or time up or down to set them.

4 Touch the OK button once settings are complete.

5 Press the [HOME] key .

It returns to the HOME screen.

Returning to Factory Settings (Initialization)

The following procedures allows you to return the system to its state when shipped from the factory.

NOTE

All the data saved on the machine is lost when it is restored to its factory settings, so consider it carefully before doing so.

- 1 Turn the power on while pressing the [HOME] key .
- 2 Once the maintenance screen opens, press the Initialize All Memories button.
This returns the system to the factory settings.

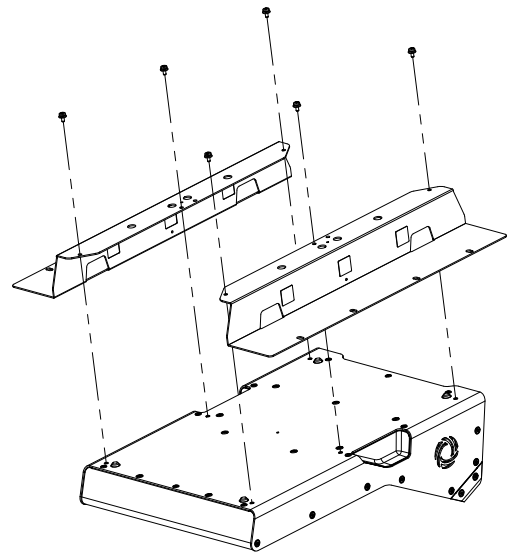

Rack Mount Kit Installation (Sold separately: RK-DM3)

 CAUTION
Precautions for Rack Mounting Operation of this product is guaranteed in the temperature range of 0 to 40°C. If mounted in an EIA standard rack with other equipment, the heat from each device raises the temperature inside the rack, which may prevent it from demonstrating its full performance. To prevent heat buildup, mount the product in a rack only under the following conditions. <ul style="list-style-type: none">• Leave at least 1U between it and other devices when mounted with devices that tend to generate heat, such as power amplifiers. Further, ensure sufficient ventilation by installing a ventilation panel in the space, or simply leave it open.

- 1 Install the rack mounting brackets.
Secure the rack mounting brackets to the unit with the 6 screws included with the rack mounting kit. The shape of the left and right rack mounting brackets is identical. Make sure there is no looseness in the rack mounting brackets.

- 2 Install in the rack.

This product requires at least 11U* of space to mount it in a rack. We recommend ensuring at least 13U* of space in order to connect its cables.

*11U is approximately 489 mm, while 13U is 578 mm.

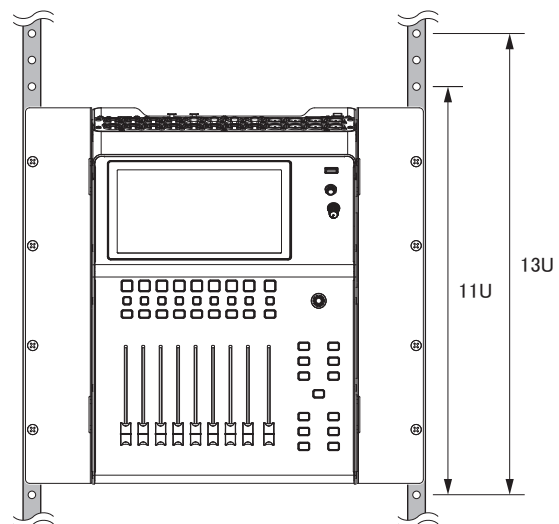

Appendix

General Specifications

Dimensions (WxHxD), Weight	320 mm × 140 mm × 455 mm, 6.5 kg
Power Consumption	43 W
Power Supply	DC24 V/2.5 A, PA-L500 (100 V-240 V, 50 Hz/60 Hz)
Temperature Range	Operating Temperature Range: 0 to 40°C Storage Temperature Range: -20 to 60°C
Sampling Frequency	96 kHz/48 kHz
Accessories	Owner's Manual, Power Adaptor (PA-L500, power cord included), DOWNLOAD INFORMATION

* The contents of this manual apply to the latest specifications as of the publishing date. To obtain the latest manual, access the Yamaha website then download the manual file.
<https://www.yamahaproaudio.com/>

Dimensions

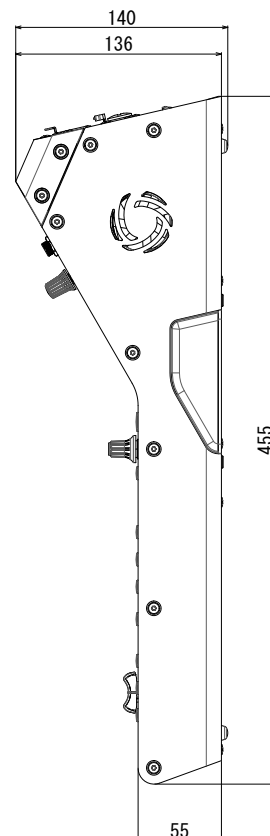
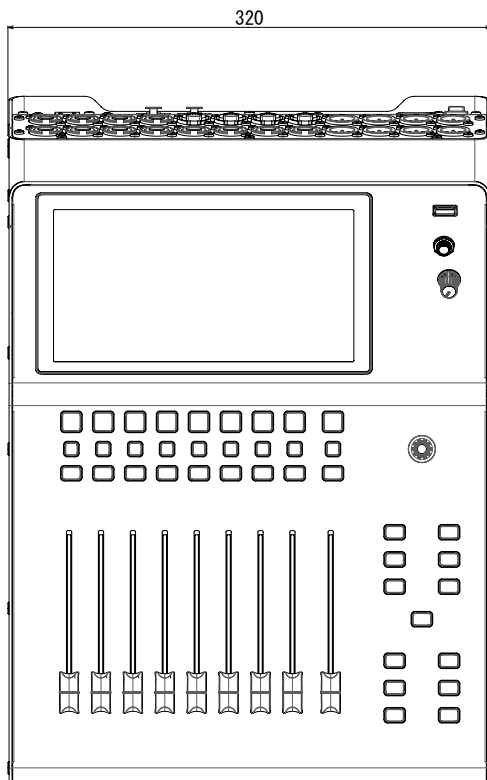
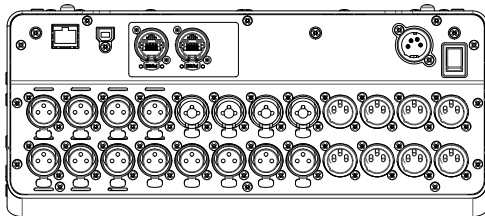

Unit: mm

Source code distribution

For three years after the final factory shipment, you may request from Yamaha the source code for any portions of the product which are licensed under the GNU General Public License/GNU Lesser General Public License/RealNetworks Public Source License by writing to the following address:

10-1 Nakazawa-cho, Naka-ku, Hamamatsu, 430-8650, JAPAN

Marketing & Sales Department, Professional Audio Division, Audio Products Business Unit, Yamaha Corporation

The source code will be provided at no charge; however, we may require you to reimburse Yamaha for the cost of delivering the source code to you. The source code can be downloaded by visiting the following URL:

<https://www.yamahaproaudio.com/>

- Note that we shall bear no responsibility whatsoever for any damage arising from changes (additions/deletions) made to the software for this product by a third party other than Yamaha (or party authorized by Yamaha).
- Note that re-use of source code released to the public domain by Yamaha is not guaranteed. Yamaha shall not bear any responsibility whatsoever for the source code.

Information for users on collection and disposal of old equipment:



This symbol on the products, packaging, and/or accompanying documents means that used electrical and electronic products should not be mixed with general household waste. For proper treatment, recovery and recycling of old products, please take them to applicable collection points, in accordance with your national legislation.

By disposing of these products correctly, you will help to save valuable resources and prevent any potential negative effects on human health and the environment which could otherwise arise from inappropriate waste handling.

For more information about collection and recycling of old products, please contact your local municipality, your waste disposal service or the point of sale where you purchased the items.

For business users in the European Union:

If you wish to discard electrical and electronic equipment, please contact your dealer or supplier for further information.

Information on Disposal in other Countries outside the European Union:

This symbol is only valid in the European Union. If you wish to discard these items, please contact your local authorities or dealer and ask for the correct method of disposal.

(weee_eu_en_02)

Energy Efficiency Information for customers in European Economic Area (EEA), Switzerland and Turkey

Energy Efficiency Information: AC adaptor PA-L500 / Input voltage : 230 V / Input AC frequency : 50 Hz / Output voltage (DC) : 24.0 V / Output current : 2.5 A / Output power : 60.0 W / Average active efficiency : 89.97 % / Efficiency at low load : 87.64 % / No-load power consumption : 0.15 W	English
Informationen zur Energieeffizienz: Netzadapter PA-L500 / Eingangsspannung: 230 V / Netzfrequenz: 50 Hz / Ausgangsspannung (U=): 24,0 V / Ausgangsstrom: 2,5 A / Ausgangsleistung: 60,0 W / Durchschnittliche Effizienz (aktiv): 89,97 % / Effizienz bei niedriger Last: 87,64 % / Stromverbrauch ohne Last: 0,15 W	Deutsch
Informations concernant l'efficacité énergétique : Adaptateur secteur PA-L500 / Tension d'entrée : 230 V / Fréquence d'entrée : 50 Hz / Tension de sortie (CC) : 24,0 V / Courant de sortie : 2,5 A / Puissance de sortie : 60,0 W / Efficacité moyenne en mode actif : 89,97 % / Efficacité à faible charge : 87,64 % / Consommation électrique sans charge : 0,15 W	Français
Informatie over energie-efficiëntie: Netadapter PA-L500 / Ingangsspanning: 230 V / Ingangsfrequentie: 50 Hz / Uitgangsspanning (DC): 24,0 V / Uitgangsstroom: 2,5 A / Uitgangsvermogen: 60,0 W / Gemiddelde actieve efficiëntie: 89,97 % / Efficiëntie bij lage belasting: 87,64 % / Stroomverbruik bij geen belasting: 0,15 W	Nederlands
Información de eficiencia energética: Adaptador de CA PA-L500 / Tensión de entrada: 230 V / Frecuencia de CA de entrada: 50 Hz / Tensión de salida (CC): 24,0 V / Corriente de salida: 2,5 A / Potencia de salida: 60,0 W / Eficiencia activa media: 89,97 % / Eficiencia con carga baja: 87,64 % / Consumo de energía sin carga: 0,15 W	Español
Informazioni sull'efficienza energetica: Adattatore CA PA-L500 / Tensione in ingresso: 230 V / Frequenza CA ingresso: 50 Hz / Tensione in uscita (CC): 24,0 V / Corrente di uscita: 2,5 A / Potenza di uscita: 60,0 W / Efficienza attiva media: 89,97 % / Efficienza a carico ridotto: 87,64 % / Consumo elettrico senza carico: 0,15 W	Italiano
Informações sobre eficiência de energia: Adaptador CA PA-L500 / Tensão de entrada: 230 V / Frequência de CA de entrada: 50 Hz / Tensão de saída (CC): 24,0 V / Corrente de saída: 2,5 A / Potência de saída: 60,0 W / Média de eficiência ativa: 89,97% / Eficiência com baixa carga: 87,64% / Consumo de energia sem carga: 0,15 W	Português
Πληροφορίες ενεργειακής απόδοσης: Προσαρμογέας AC PA-L500 / Τάση εισόδου: 230 V / Συχνότητα εισόδου AC: 50 Hz / Τάση εξόδου (DC): 24,0 V / Ρεύμα εξόδου: 2,5 A / Ισχύς εξόδου: 60,0 W / Μέση ενεργός απόδοση: 89,97% / Απόδοση σε χαμηλό φορτίο: 87,64% / Κατανάλωση ισχύος άνευ φορτίου: 0,15 W	Ελληνικά
Information om energieeffektivitet: Nätdapter PA-L500 / Inspänning: 230 V / Växelströmsfrekvens in: 50 Hz / Utspänning (Likström): 24,0 V / Utgående ström: 2,5 A / Uteffekt: 60,0 W / Genomsnittlig aktiv effektivitet: 89,97 % / Effektivitet vid låg belastning: 87,64 % / Energiförbrukning utan belastning: 0,15 W	Svenska
Oplysninger om energieffektivitet: AC-adapter PA-L500/indgangsspænding: 230 V/indgangs-AC-frekvens: 50 Hz/udgangsspænding (DC): 24,0 V/udgangsstrøm: 2,5 A/udgangseffekt: 60,0 W/gennemsnitlig aktiv effektivitet: 89,97 %/effektivitet ved lav belastning: 87,64 %/strømforbrug ved ingen belastning: 0,15 W	Dansk
Energiatohokkuus tiedot: Verkkoalaite PA-L500 / Tulojännite : 230 V / Tulojännitteen taajuus : 50 Hz / Lähtöjännite (DC) : 24,0 V / Lähtövirta : 2,5 A / Lähtöteho : 60,0 W / Keskimääräinen tehokkuus käytössä : 89,97 % / Tehokkuus pienellä kuormalla : 87,64 % / Kulutus kuormittamattomana : 0,15 W	Suomi
Informacje o efektywności energetycznej: Zasilacz sieciowy PA-L500 / Napięcie wyjściowe: 230 V / Częstotliwość napięcia zasilania prądem zmiennym: 50 Hz / Napięcie wyjściowe (DC): 24,0 V / Prąd wyjściowy: 2,5 A / Maksymalna wyjściowa: 60,0 W / Średnia sprawność robocza: 89,97 % / Sprawność przy niskim poziomie obciążenia: 87,64% / Zużycie energii bez obciążenia: 0,15 W	Polski
Informace o energetické účinnosti: Adaptér napájení PA-L500 / Vstupní napětí: 230 V / Vstupní frekvence střídavého proudu: 50 Hz / Výstupní napětí (DC): 24,0 V / Výstupní proud: 2,5 A / Výstupní výkon: 60,0 W / Průměrná účinnost v aktivním režimu: 89,97 % / Účinnost při nízké zátěži: 87,64 % / Spotřeba ve stavu bez zátěže: 0,15 W	Čeština
Energiahatékonysági adatok: PA-L500 hálózati adapter / Beviteli feszültség: 230 V / Beviteli hálózati frekvencia: 50 Hz / Kimeneti feszültség (DC): 24,0 V / Kimenő áramerősség: 2,5 A / Kimeneti teljesítmény: 60,0 W / Átlagos aktív teljesítmény: 89,97% / Hatékonyság alacsony töltésnél: 87,64% / Teljesítményfelvétel nem töltöttségénél: 0,15 W	Magyar
Energiatõhususe teave: AC-adapter PA-L500 / Sisendpinge: 230 V / Sisendi voolusagedus: 50 Hz / Väljundpinge (DC): 24,0 V / Väljundvool: 2,5 A / Väljundvõimsus: 60,0 W / Tõõseisundi keskmine kasutegur: 89,97% / Tõõhusus väikese koormuse juures: 87,64% / Energiatarbimine koormamata seisundis: 0,15 W	Eesti
Informācija par energoefektivitāti: Maiņstrāvas adapteris PA-L500 / Ieejas spriegums: 230 V / Ieejas maiņstrāvas frekvence: 50 Hz / Izejas spriegums (līdzstrāva): 24,0 V / Izejas strāva: 2,5 A / Izejas jauda: 60,0 W / Vidējā aktīvā efektivitāte: 89,97 % / Efektivitāte ar mazu slodzi: 87,64 % / Enerģijas patēriņš bez slodzes: 0,15 W	Latviešu
Energijos naudojimo efektyvumo informacija: Kintamosios srovės adapteris PA-L500 / Įėjimo įtampa: 230 V / Įėjimo kintamosios srovės dažnis: 50 Hz / Išėjimo įtampa (nuolatinė srovė): 24,0 V / Išėjimo srovė: 2,5 A / Išvesties galia: 60,0 W / Vidutinis efektyvumas aktyviojo režimo: 89,97 % / Efektyvumas esant mažai apkrovai: 87,64 % / Energijos sąnaudos be apkrovos: 0,15 W	Lietuvių
Informácie o energetickej účinnosti: Adaptér napájania PA-L500 / Vstupné napätie: 230 V / Vstupná frekvencia striedavého prúdu: 50 Hz / Výstupné napätie (DC): 24,0 V / Výstupný prúd: 2,5 A / Výstupný výkon: 60,0 W / Priemerná účinnosť v aktívnom režime: 89,97 % / Účinnosť pri nízkej záťaži: 87,64 % / Spotreba v stave bez záťaže: 0,15 W	Slovenčina
Podatki o energetske učinkovitosti: Električni napajalnik PA-L500 / Vhodna napetost: 230 V / Vhodna frekvenca izmeničnega toka: 50 Hz / Izhodna napetost (enosmerni tok): 24,0 V / Izhodni tok: 2,5 A / Izhodna moč: 60,0 W / Povprečna učinkovitost – v času delovanja: 89,97 % / Učinkovitost pri nižji obremenitvi: 87,64 % / Poraba energije – brez obremenitve: 0,15 W	Slovenščina
Информация за енергийна ефективност: Адаптер за променливотоково захранване PA-L500 / Входно напрежение : 230 V / Входна честота (променлив ток) : 50 Hz / Изходно напрежение (постоянен ток) : 24,0 V / Изходен ток : 2,5 A / Изходна мощност : 60,0 W / Средна активна ефективност : 89,97 % / Ефективност при ниско натоварване : 87,64 % / Консумация на енергия без натоварване : 0,15 W	Български
Informații privind eficiența energetică: Adaptor CA PA-L500 / Tensiune de intrare: 230 V / Frecvență CA de intrare: 50 Hz / Tensiune de ieșire (CC): 24,0 V / Curent de ieșire: 2,5 A / Putere de ieșire: 60,0 W / Eficiență activă medie: 89,97 % / Eficiență la sarcină redusă: 87,64 % / Consum electric fără sarcină: 0,15 W	Română
Informacije o energetskej učinkovitosti: Prilagodnik izmjeničnog napajanja PA-L500 / Ulazni napon: 230 V / Ulazna frekvencija izmjeničnog napajanja: 50 Hz / Izlazni napon (istosmjerna struja): 24,0 V / Izlazna struja: 2,5 A / Izlazna snaga: 60,0 W / Prosječna aktivna učinkovitost: 89,97 % / Učinkovitost pri niskom opterećenju: 87,64 % / Potrošnja energije bez opterećenja: 0,15 W	Hrvatski
Enerji Verimliliği Bilgileri: AC adaptörü PA-L500 / Giriş gerilimi : 230 V / Giriş AC frekansı : 50 Hz / Çıkış gerilimi (DC) : 24,0 V / Çıkış akımı : 2,5 A / Çıkış gücü : 60,0 W / Ortalama etkin verimlilik : %89,97 / Düşük yükte verimlilik : %87,64 / Yüksüz güç tüketimi : 0,15 W	Türkçe

Important Notice: Guarantee Information for customers in European Economic Area (EEA) and Switzerland

Important Notice: Guarantee Information for customers in EEA* and Switzerland For detailed guarantee information about this Yamaha product, and Pan-EEA* and Switzerland warranty service, please either visit the website address below (Printable file is available at our website) or contact the Yamaha representative office for your country. * EEA: European Economic Area	English
Wichtiger Hinweis: Garantie-Information für Kunden in der EWR* und der Schweiz Für nähere Garantie-Information über dieses Produkt von Yamaha, sowie über den Pan-EWR*- und Schweizer Garantieservice, besuchen Sie bitte entweder die folgend angegebene Internetadresse (eine druckfähige Version befindet sich auch auf unserer Webseite), oder wenden Sie sich an den für Ihr Land zuständigen Yamaha-Vertrieb. *EWR: Europäischer Wirtschaftsraum	Deutsch
Remarque importante: informations de garantie pour les clients de l'EEE et la Suisse Pour des informations plus détaillées sur la garantie de ce produit Yamaha et sur le service de garantie applicable dans l'ensemble de l'EEE ainsi qu'en Suisse, consultez notre site Web à l'adresse ci-dessous (le fichier imprimable est disponible sur notre site Web) ou contactez directement Yamaha dans votre pays de résidence. * EEE : Espace Economique Européen	Français
Belangrijke mededeling: Garantie-informatie voor klanten in de EER* en Zwitserland Voor gedetailleerde garantie-informatie over dit Yamaha-product en de garantieservice in heel de EER* en Zwitserland, gaat u naar de onderstaande website (u vindt een afdrukbaar bestand op onze website) of neemt u contact op met de vertegenwoordiging van Yamaha in uw land. * EER: Europese Economische Ruimte	Nederlands
Aviso importante: información sobre la garantía para los clientes del EEE* y Suiza Para una información detallada sobre este producto Yamaha y sobre el soporte de garantía en la zona EEE* y Suiza, visite la dirección web que se incluye más abajo (la versión del archivo para imprimir esta disponible en nuestro sitio web) o póngase en contacto con el representante de Yamaha en su país. * EEE: Espacio Económico Europeo	Español
Avviso importante: informazioni sulla garanzia per i clienti residenti nell'EEA* e in Svizzera Per informazioni dettagliate sulla garanzia relativa a questo prodotto Yamaha e l'assistenza in garanzia nei paesi EEA* e in Svizzera, potete consultare il sito Web all'indirizzo riportato di seguito (è disponibile il file in formato stampabile) oppure contattare l'ufficio di rappresentanza locale della Yamaha. * EEA: Area Economica Europea	Italiano
Aviso importante: informações sobre as garantias para clientes da AEE* e da Suíça Para obter uma informação pormenorizada sobre este produto da Yamaha e sobre o serviço de garantia na AEE* e na Suíça, visite o site a seguir (o arquivo para impressão está disponível no nosso site) ou entre em contato com o escritório de representação da Yamaha no seu país. * AEE: Área Económica Européia	Português
Σημαντική σημείωση: Πληροφορίες εγγύησης για τους πελάτες στον ΕΟΧ* και Ελλάδα Για λεπτομερείς πληροφορίες εγγύησης σχετικά με το παρόν προϊόν της Yamaha και την κάλυψη εγγύησης σε όλες τις χώρες του ΕΟΧ και την Ελλάδα, επισκεφτείτε την παρακάτω ιστοσελίδα (Εκτυπώσιμη μορφή είναι διαθέσιμη στην ιστοσελίδα μας) ή απευθυνθείτε στην αντιπροσωπεία της Yamaha στη χώρα σας. * ΕΟΧ: Ευρωπαϊκός Οικονομικός Χώρος	Ελληνικά
Viktigt: Garantiinformation för kunder i EES-området* och Schweiz För detaljerad information om denna Yamahaprodukt samt garantiservice i hela EES-området* och Schweiz kan du antingen besöka nedanstående webbadress (en utskriftsvänlig fil finns på webbplatsen) eller kontakta Yamahas officiella representant i ditt land. * EES: Europeiska Ekonomiska Samarbetsområdet	Svenska
Viktig merknad: Garantiinformasjon for kunder i EØS* og Sveits Detaljert garantiinformasjon om dette Yamaha-produktet og garantiservice for hele EØS-området* og Sveits kan fås enten ved å besøke nettstedene nedenfor (utskriftsversjon finnes på våre nettsider) eller kontakte Yamahas kontoret i landet der du bor. *EØS: Det europeiske økonomiske samarbeidsområdet	Norsk
Vigtig oplysning: Garantioplysninger til kunder i EØ* og Schweiz De kan finde detaljerede garantioplysninger om dette Yamaha-produkt og den fælles garantiserviceordning for EØ* (og Schweiz) ved at besøge det websted, der er angivet nedenfor (der findes en fil, som kan udskrives, på vores websted), eller ved at kontakte Yamahas nationale repræsentationskontor i det land, hvor De bor. * EØ: Det Europæiske Økonomiske Område	Dansk
Tärkeä ilmoitus: Takuutiedot Euroopan talousalueen (ETA)* ja Sveitsin asiakkaille Tämän Yamaha-tuotteen sekä ETA-alueen ja Sveitsin takuuta koskevat yksityiskohtaiset tiedot saatte alla olevasta nettiosoitteesta. (Tulostettava tiedosto saatavissa sivustollamme.) Voititte myös ottaa yhteyttä paikalliseen Yamaha-edustajaan. *ETA: Euroopan talousalue	Suomi
Ważne: Warunki gwarancyjne obowiązujące w EOG* i Szwajcarii Aby dowiedzieć się więcej na temat warunków gwarancyjnych tego produktu firmy Yamaha i serwisu gwarancyjnego w całym EOG* i Szwajcarii, należy odwiedzić wskazaną poniżej stronę internetową (Plik gotowy do wydruku znajduje się na naszej stronie internetowej) lub skontaktować się z przedstawicielstwem firmy Yamaha w swoim kraju. * EOG — Europejski Obszar Gospodarczy	Polski
Důležité oznámení: Záruční informace pro zákazníky v EHS* a ve Švýcarsku Podrobné záruční informace o tomto produktu Yamaha a záručním servisu v celém EHS* a ve Švýcarsku naleznete na níže uvedené webové adrese (soubor k tisku je dostupný na našich webových stránkách) nebo se můžete obrátit na zastoupení firmy Yamaha ve své zemi. * EHS: Evropský hospodářský prostor	Česky
Fontos figyelemztetés: Garancia-információk az EGT* területén és Svájcban élő vásárlók számára A jelen Yamaha termékre vonatkozó részletes garancia-információk, valamint az EGT*-re és Svájcra kiterjedő garanciális szolgáltatás tekintetében keresse fel webhelyünket az alábbi címen (a webhelyen nyomtatható fájl is található), vagy pedig lépjen kapcsolatba az országában működő Yamaha képviselői irodával. * EGT: Európai Gazdasági Térség	Magyar
Oluline märkus: Garantiiteave Euroopa Majanduspiirkonna (EMP)* ja Šveitsi klientidele Täpsemate teabe saamiseks selle Yamaha toote garantii ning kogu Euroopa Majanduspiirkonna ja Šveitsi garantiiteeninduse kohta, külastage palun veebisaiti alljärgneval aadressil (meie saidil on saadaval printitav fail) või pöörduge Teie regiooni Yamaha esinduse poole. * EMP: Euroopa Majanduspiirkond	Eesti keel
Svarīgs paziņojums: garantijas informācija klientiem EEZ* un Šveicē Lai saņemtu detalizētu garantijas informāciju par šo Yamaha produktu, kā arī garantijas apkalpošanu EEZ* un Šveicē, lūdzu, apmeklējiet zemāk norādīto tīmekļa vietnes adresi (tīmekļa vietnē ir pieejams drukājams fails) vai sazinieties ar jūsu valsti apkalpojošo Yamaha pārstāvniecību. * EEZ: Eiropas Ekonomikas zona	Latviešu
Dėmesio: informacija dėl garantijos pirkėjams EEE* ir Šveicarijoje Jei reikia išsamios informacijos apie šį „Yamaha“ produktą ir jo techninę priežiūrą visoje EEE* ir Šveicarijoje, apsilankykite mūsų svetainėje toliau nurodytu adresu (svetainėje yra spausdintinas failas) arba kreipkitės į „Yamaha“ atstovybę savo šaliai. *EEE – Europos ekonominė erdvė	Lietuvių kalba
Dôležité upozornenie: Informácie o záruke pre zákazníkov v EHP* a Švajčiarsku Podrobné informácie o záruke týkajúce sa tohto produktu od spoločnosti Yamaha a garančnom servise v EHP* a Švajčiarsku nájdete na webovej stránke uvedenej nižšie (na našej webovej stránke je k dispozícii súbor na tlač) alebo sa obráťte na zástupcu spoločnosti Yamaha vo svojej krajine. * EHP: Európsky hospodársky priestor	Slovenčina
Pomembno obvestilo: Informacije o garanciji za kupce v EGP* in Švici Za podrobnejše informacije o tem Yamahinem izdelku ter garancijskem servisu v celotnem EGP in Švici, obiščite spletno mesto, ki je navedeno spodaj (natisljiva datoteka je na voljo na našem spletnem mestu), ali se obrnite na Yamahinega predstavnika v svoji državi. * EGP: Evropski gospodarski prostor	Slovenščina
Важно съобщение: Информация за гаранцията за клиенти в ЕИП* и Швейцария За подробна информация за гаранцията за този продукт на Yamaha и гаранционното обслужване в паневропейската зона на ЕИП* и Швейцария или посетете посочения по-долу уеб сайт (на нашия уеб сайт има файл за печат), или се свържете с представителния офис на Yamaha във вашата страна. * ЕИП: Европейско икономическо пространство	Български език
Notificare importantă: Informații despre garanție pentru clienții din SEE* și Elveția Pentru informații detaliate privind acest produs Yamaha și serviciul de garanție Pan-SEE* și Elveția, vizitați site-ul la adresa de mai jos (fișierul imprimabil este disponibil pe site-ul nostru) sau contactați biroul reprezentanței Yamaha din țara dumneavoastră. * SEE: Spațiul Economic European	Limba română
Važna obavijest: Informacije o jamstvu za države EGP-a i Švicarske Za detaljne informacije o jamstvu za ovaj Yamahin proizvod te jamstvenom servisu za cijeli EGP i Švicarsku, molimo Vas da posjetite web-stranicu navedenu u nastavku ili kontaktirate ovlaštenog Yamahinog dobavljača u svojoj zemlji. * EGP: Europski gospodarski prostor	Hrvatski

<https://europe.yamaha.com/warranty/>

MEMO

MEMO

ADDRESS LIST

NORTH AMERICA

CANADA

Yamaha Canada Music Ltd.
135 Milner Avenue, Toronto, Ontario,
M1S 3R1, Canada
Tel: +1-416-298-1311

U.S.A.

Yamaha Corporation of America
6600 Orangethorpe Avenue, Buena Park, CA
90620, U.S.A.
Tel: +1-714-522-9011

CENTRAL & SOUTH AMERICA

MEXICO

Yamaha de México, S.A. de C.V.
Av. Insurgentes Sur 1647 Piso 9, Col. San José
Insurgentes, Delegación Benito Juárez, CDMX,
C.P. 03900, México
Tel: +52-55-5804-0600

BRAZIL

Yamaha Musical do Brasil Ltda.
Praça Professor José Lannes, 40-Cjs 21 e 22,
Brooklin Paulista Novo CEP 04571-100 – São
Paulo – SP, Brazil
Tel: +55-11-3704-1377

ARGENTINA

**Yamaha Music Latin America, S.A.,
Sucursal Argentina**
Olga Cossettini 1553, Piso 4 Norte,
Madero Este-C1107CEK,
Buenos Aires, Argentina
Tel: +54-11-4119-7000

PANAMA AND OTHER LATIN AMERICAN/CARIBBEAN REGIONS

Yamaha Music Latin America, S.A.
Edif. Torre Banco General, Piso 7, Urbanización
Marbella, Calle 47 y Aquilino de la Guardia,
Ciudad de Panamá, República de Panamá
Tel: +507-269-5311

EUROPE

THE UNITED KINGDOM/IRELAND

Yamaha Music Europe GmbH (UK)
Sherbourne Drive, Tilbrook, Milton Keynes,
MK7 8BL, U.K.
Tel: +44-1908-366700

GERMANY

Yamaha Music Europe GmbH
Siemensstrasse 22-34, 25462 Rellingen, Germany
Tel: +49-4101-303-0

SWITZERLAND/LIECHTENSTEIN

**Yamaha Music Europe GmbH, Branch
Switzerland in Thalwil**
Seestrasse 18a, 8800 Thalwil, Switzerland
Tel: +41-44-3878080

AUSTRIA/BULGARIA/ CZECH REPUBLIC/HUNGARY/ ROMANIA/SLOVAKIA/SLOVENIA

**Yamaha Music Europe GmbH
Branch Austria**
Schleiergasse 20, 1100 Wien, Austria
Tel: +43-1-60203900

POLAND

**Yamaha Music Europe
Sp.z o.o. Oddział w Polsce**
ul. Młynarska 48, 01-171 Warszawa, Poland
Tel: +48-22-880-08-88

MALTA

Olimpus Music Ltd.
Valletta Road, Mosta MST9010, Malta
Tel: +356-2133-2093

NETHERLANDS/BELGIUM/ LUXEMBOURG

Yamaha Music Europe Branch Benelux
Wattbaan 1 3439ML Nieuwegein, The Netherlands
Tel: +31-347-358040

FRANCE

Yamaha Music Europe
7 rue Ambroise Croizat, Zone d'activités de Pariest,
77183 Croissy-Beaubourg, France
Tel: +33-1-6461-4000

ITALY

Yamaha Music Europe GmbH, Branch Italy
Via Tinelli N.67/69 20855 Gerno di Lesmo (MB),
Italy
Tel: +39-039-9065-1

SPAIN/PORTUGAL

**Yamaha Music Europe GmbH Ibérica, Sucursal
en España**
Ctra. de la Coruña km. 17,200, 28231
Las Rozas de Madrid, Spain
Tel: +34-91-639-88-88

GREECE

Philippos Nakas S.A. The Music House
19th klm. Leof. Lavriou 190 02 Peania – Attiki,
Greece
Tel: +30-210-6686168

SWEDEN/FINLAND/ICELAND

**Yamaha Music Europe GmbH Germany Filial
Scandinavia**
JA Wettergrensgata 1, 400 43 Göteborg, Sweden
Tel: +46-31-89-34-00

DENMARK

**Yamaha Music Denmark,
Filial of Yamaha Music Europe GmbH, Tyskland**
Generatorvej 8C, ST. TH. , 2860 Søborg, Denmark
Tel: +45-44-92-49-00

NORWAY

**Yamaha Music Europe GmbH Germany -
Norwegian Branch**
c/o Box 30053, 400 43 Göteborg, Sweden
Tel: +47-6716-7800

CYPRUS

Yamaha Music Europe GmbH
Siemensstrasse 22-34, 25462 Rellingen, Germany
Tel: +49-4101-303-0

RUSSIA

Yamaha Music (Russia) LLC.
Room 37, entrance 7, bld. 7, Kievskaya street,
Moscow, 121059, Russia
Tel: +7-495-626-5005

OTHER EUROPEAN REGIONS

Yamaha Music Europe GmbH
Siemensstrasse 22-34, 25462 Rellingen, Germany
Tel: +49-4101-3030

AFRICA

Yamaha Music Gulf FZE
JAFZA-16, Office 512, P.O.Box 17328,
Jebel Ali FZE, Dubai, UAE
Tel: +971-4-801-1500

MIDDLE EAST

TURKEY

Ertekin Elektronik tic. ve san. as
Kagithane Ofis Park Baglar Cad.
No: 14 D/6 Kagithane 34406
ISTANBUL / TÜRKIYE
Tel: +90-212-312-24-24

OTHER REGIONS

Yamaha Music Gulf FZE
JAFZA-16, Office 512, P.O.Box 17328,
Jebel Ali FZE, Dubai, UAE
Tel: +971-4-801-1500

ASIA

MAINLAND CHINA

Yamaha Music & Electronics (China) Co.,Ltd.
2F, Yunhedasha, 1818 Xinzha-lu, Jingan-qu,
Shanghai, China
Tel: +86-400-051-7700

INDIA

Yamaha Music India Private Limited
P-401, JMD Megapolis, Sector-48, Sohna Road,
Gurugram-122018, Haryana, India
Tel: +91-124-485-3300

INDONESIA

PT Yamaha Musik Indonesia Distributor
Yamaha Music Center Bldg. Jalan Jend. Gatot
Subroto Kav. 4, Jakarta 12930, Indonesia
Tel: +62-21-520-2577

KOREA

Yamaha Music Korea Ltd.
11F, Prudential Tower, 298, Gangnam-daero,
Gangnam-gu, Seoul, 06253, Korea
Tel: +82-2-3467-3300

MALAYSIA

Yamaha Music (Malaysia) Sdn. Bhd.
No.8, Jalan Perbandaran, Kelana Jaya, 47301
Petaling Jaya, Selangor, Malaysia
Tel: +60-3-78030900

SINGAPORE

Yamaha Music (Asia) Private Limited
Block 202 Hougang Street 21, #02-00,
Singapore 530202, Singapore
Tel: +65-6740-9200

TAIWAN

Yamaha Music & Electronics Taiwan Co.,Ltd.
2F., No.1, Yuandong Rd., Banqiao Dist.,
New Taipei City 22063, Taiwan
Tel: +886-2-7741-8888

THAILAND

Siam Music Yamaha Co., Ltd.
3, 4, 15, 16th Fl., Siam Motors Building,
891/1 Rama 1 Road, Wangmai,
Pathumwan, Bangkok 10330, Thailand
Tel: +66-2215-2622

VIETNAM

Yamaha Music Vietnam Company Limited
15th Floor, Nam A Bank Tower, 201-203 Cach
Mang Thang Tam St., Ward 4, Dist.3,
Ho Chi Minh City, Vietnam
Tel: +84-8-3818-1122

OTHER ASIAN REGIONS

<http://asia.yamaha.com/>

OCEANIA

AUSTRALIA

Yamaha Music Australia Pty. Ltd.
Level 1, 80 Market Street, South Melbourne,
VIC 3205, Australia
Tel: +61-3-9693-5111

REGIONS AND TRUST TERRITORIES IN PACIFIC OCEAN

<http://asia.yamaha.com/>

Yamaha Pro Audio global website
<https://www.yamahaproaudio.com/>
Yamaha Downloads
<https://download.yamaha.com/>

© 2021 Yamaha Corporation
Published 02/2023
NVEM-B1

