



  
STAIRVILLE

HL-x9 Quad Color  
HL-x9 W QCL RGBW  
HL-x9 W QCL RGB WW  
HL-x9 QCL RGB WW  
Flood 9x8W  
LED floodlight

Musikhaus Thomann  
Thomann GmbH  
Hans-Thomann-Straße 1  
96138 Burgebrach  
Germany  
Telephone: +49 (0) 9546 9223-0  
E-mail: [info@thomann.de](mailto:info@thomann.de)  
Internet: [www.thomann.de](http://www.thomann.de)

29.03.2019, ID: 288505, 418753, 418758, 418760 (V4)

# Table of contents

<b>1</b>	<b>General information</b> .....	<b>5</b>
	1.1 Further information.....	6
	1.2 Notational conventions.....	7
	1.3 Symbols and signal words.....	7
<b>2</b>	<b>Safety instructions</b> .....	<b>10</b>
<b>3</b>	<b>Features</b> .....	<b>16</b>
<b>4</b>	<b>Installation</b> .....	<b>18</b>
<b>5</b>	<b>Starting up</b> .....	<b>22</b>
<b>6</b>	<b>Connections and operating elements</b> .....	<b>25</b>
<b>7</b>	<b>Operating</b> .....	<b>28</b>
	7.1 Starting up the device.....	28
	7.2 Main menu.....	28
	7.3 Menu overview.....	35
	7.4 Functions in 4-channel DMX mode.....	36
	7.5 Functions in 6-channel DMX mode.....	36

HL-x9 Quad Color HL-x9 W QCL RGBW HL-x9 W QCL RGB WW  
HL-x9 QCL RGB WWFlood 9x8W

	7.6 Functions in 8-channel DMX mode.....	38
<b>8</b>	<b>Technical specifications.....</b>	<b>40</b>
<b>9</b>	<b>Plug and connection assignments.....</b>	<b>43</b>
<b>10</b>	<b>Troubleshooting.....</b>	<b>44</b>
<b>11</b>	<b>Cleaning.....</b>	<b>46</b>
<b>12</b>	<b>Protecting the environment.....</b>	<b>47</b>

# 1 General information

This user manual contains important information on the safe operation of the device. Read and follow all safety notes and all instructions. Save this manual for future reference. Make sure that it is available to all persons using this device. If you sell the device to another user, be sure that they also receive this manual.

Our products and user manuals are subject to a process of continuous development. We therefore reserve the right to make changes without notice. Please refer to the latest version of the user manual which is ready for download under [www.thomann.de](http://www.thomann.de).

## 1.1 Further information

On our website ([www.thomann.de](http://www.thomann.de)) you will find lots of further information and details on the following points:

Download	This manual is also available as PDF file for you to download.
Keyword search	Use the search function in the electronic version to find the topics of interest for you quickly.
Online guides	Our online guides provide detailed information on technical basics and terms.
Personal consultation	For personal consultation please contact our technical hotline.
Service	If you have any problems with the device the customer service will gladly assist you.

## 1.2 Notational conventions

This manual uses the following notational conventions:

### Letterings

The letterings for connectors and controls are marked by square brackets and italics.

**Examples:** *[VOLUME]* control, *[Mono]* button.



### Displays

Texts and values displayed on the device are marked by quotation marks and italics.



**Examples:** *'24ch'*, *'OFF'*.

## 1.3 Symbols and signal words

In this section you will find an overview of the meaning of symbols and signal words that are used in this manual.

Signal word	Meaning
<b>DANGER!</b>	This combination of symbol and signal word indicates an immediate dangerous situation that will result in death or serious injury if it is not avoided.
<b>WARNING!</b>	This combination of symbol and signal word indicates a possible dangerous situation that can result in death or serious injury if it is not avoided.
<b>NOTICE!</b>	This combination of symbol and signal word indicates a possible dangerous situation that can result in material and environmental damage if it is not avoided.
Warning signs	Type of danger
	Warning – high-voltage.
	Warning – dangerous optical radiation.



Warning signs	Type of danger
	Warning – suspended load.
	Warning – danger zone.

HL-x9 Quad Color HL-x9 W QCL RGBW HL-x9 W QCL RGB WW  
 HL-x9 QCL RGB WWFlood 9x8W

## 2 Safety instructions

### **Intended use**

This device is intended for use as an electronic lighting effect by means of LED technology. The device is designed for professional use and is not suitable for use in households. Use the device only as described in this user manual. Any other use or use under other operating conditions is considered to be improper and may result in personal injury or property damage. No liability will be assumed for damages resulting from improper use.

This device may be used only by persons with sufficient physical, sensorial, and intellectual abilities and having corresponding knowledge and experience. Other persons may use this device only if they are supervised or instructed by a person who is responsible for their safety.

Extend the life of the device by regular breaks in operation and avoid switching it on and off frequently. This device is not suitable for continuous use.

**Safety**



**DANGER!**

**Danger for children**

Ensure that plastic bags, packaging, etc. are disposed of properly and are not within reach of babies and young children. Choking hazard!

Ensure that children do not detach any small parts (e.g. knobs or the like) from the unit. They could swallow the pieces and choke!

Never let children unattended use electrical devices.



**DANGER!**

**Electric shock caused by high voltages inside**

Within the device there are areas where high voltages may be present. Never remove any covers.

There are no user-serviceable parts inside.

Do not use the device if covers, protectors or optical components are missing or damaged.

HL-x9 Quad Color HL-x9 W QCL RGBW HL-x9 W QCL RGB WW  
HL-x9 QCL RGB WW Flood 9x8W



### **DANGER!**

#### **Electric shock caused by short-circuit**

Always use proper ready-made insulated mains cabling (power cord) with a protective contact plug. Do not modify the mains cable or the plug. Failure to do so could result in electric shock/death or fire. If in doubt, seek advice from a registered electrician.



### **WARNING!**

#### **Eye damage caused by high light intensity**

Never look directly into the light source.



### **WARNING!**

#### **Risk of epileptic shock**

Strobe lighting can trigger seizures in photosensitive epilepsy. Sensitive persons should avoid looking at strobe lights.



**NOTICE!**

**Risk of fire**

Do not block areas of ventilation. Do not install the device near any direct heat source. Keep the device away from naked flames.

HL-x9 Quad Color HL-x9 W QCL RGBW HL-x9 W QCL RGB WW  
HL-x9 QCL RGB WWFlood 9x8W



### **NOTICE!**

#### **Operating conditions**

This device has been designed for indoor use only. To prevent damage, never expose the device to any liquid or moisture. Avoid direct sunlight, heavy dirt, and strong vibrations.

Only operate the device within the ambient conditions specified in the chapter 'Technical specifications' of this user manual. Avoid heavy temperature fluctuations and do not switch the device on immediately after it was exposed to temperature fluctuations (for example after transport at low outside temperatures).

Dust and dirt inside can damage the unit. When operated in harmful ambient conditions (dust, smoke, nicotine, fog, etc.), the unit should be maintained by qualified service personnel at regular intervals to prevent overheating and other malfunction.



**NOTICE!**

**Power supply**

Before connecting the device, ensure that the input voltage (AC outlet) matches the voltage rating of the device and that the AC outlet is protected by a residual current circuit breaker. Failure to do so could result in damage to the device and possibly injure the user.

Unplug the device before electrical storms occur and when it is unused for long periods of time to reduce the risk of electric shock or fire.

### 3 Features

Special features of the device:

- 9 four-colour LEDs, 8 W each
  - HL-x9 Quad Color (item no. 288505): red, green, blue, white
  - HL-x9 W QCL RGBW (item no. 418753): red, green, blue, white
  - HL-x9 W QCL RGB WW (item no. 418758): red, green, blue, warm white
  - HL-x9 QCL RGB WW (item no. 418760): red, green, blue, warm white
- Stand-alone, master-slave or DMX mode operation
- Operating via buttons and display on the unit
- Robust metal housing with four adjustable barn doors attached to it
- Housing colour:
  - HL-x9 Quad Color (item no. 288505): black
  - HL-x9 W QCL RGBW (item no. 418753): white
  - HL-x9 W QCL RGB WW (item no. 418758): white
  - HL-x9 QCL RGB WW (item no. 418760): black
- The universal mounting bracket allows mounting to wall, ceiling or floor, with optional accessories also on stands or trusses
- Suitable for use in clubs, bars, stages, exhibitions, etc.



For technological reasons, the light output of LEDs decreases over their lifetime. This effect increases with higher operating temperature. You can extend the service life of the illuminants by providing adequate ventilation and operating the LEDs with the lowest possible brightness.

HL-x9 Quad Color HL-x9 W QCL RGBW HL-x9 W QCL RGB WW  
HL-x9 QCL RGB WWFlood 9x8W

## 4 Installation

Unpack and check carefully there is no transportation damage before using the unit. Keep the equipment packaging. To fully protect the product against vibration, dust and moisture during transportation or storage use the original packaging or your own packaging material suitable for transport or storage, respectively.



### **WARNING!**

#### **Risk of injury caused by falling objects**

Make sure that the installation complies with the standards and rules that apply in your country. Always secure the device with a secondary safety attachment, such as a safety cable or a safety chain.



**NOTICE!**

**Risk of overheating**

The distance between light output and the illuminated surface must be more than 1.5 m (19.7in).

Provide sufficient ventilation.

The ambient temperature must always be below 40 °C (104 °F).



**NOTICE!**

**Use of stands**

When mounting the device onto a stand, ensure that the stand is in a safe and stable position and that the weight of the device does not exceed the maximum permissible load capacity of the stand.



### **NOTICE!**

#### **Possible data transmission errors**

For error-free operation make use of dedicated DMX cables and do not use ordinary microphone cables.

Never connect the DMX input or output to audio devices such as mixers or amplifiers.

### **Mounting options**

Sie können das Gerät stehend oder (mit dem optional erhältlichen Zubehör) hängend installieren. When in use, the device must always be attached to a solid surface or an approved truss. Use the openings of the bracket provided for mounting.

Always work from a stable platform whenever installing, moving or servicing the unit. In doing so, the area underneath the unit must be cordoned off.

The safety cable must be attached to the bracket.



*Please note that this device must not be connected to a dimmer.*

HL-x9 Quad Color HL-x9 W QCL RGBW HL-x9 W QCL RGB WW  
HL-x9 QCL RGB WWFlood 9x8W

## 5 Starting up

Create all connections while the device is off. Use the shortest possible high-quality cables for all connections. Take care when running the cables to prevent tripping hazards.

## Connections in DMX mode

Connect the DMX input of the device to the DMX output of a DMX controller or another DMX device. Connect the output of the first DMX device to the input of the second one, and so on to form a daisy chain. Always ensure that the output of the last DMX device in the daisy chain is terminated with a resistor ( $110\ \Omega$ ,  $\frac{1}{4}\ \text{W}$ ).

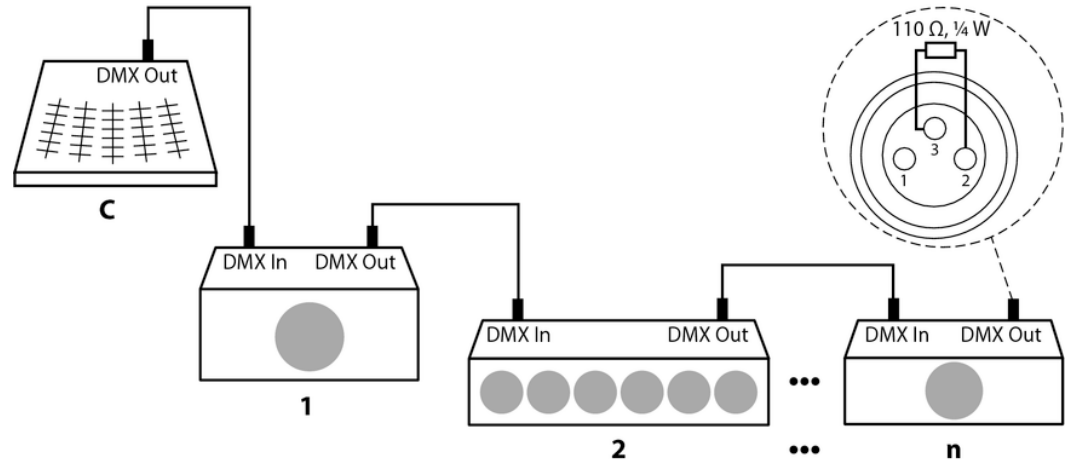

HL-x9 Quad Color HL-x9 W QCL RGBW HL-x9 W QCL RGB WW  
HL-x9 QCL RGB WWFlood 9x8W

### **Connections in master/slave mode**

When you configure a group of devices in master/slave mode, the first unit will control the other units for an automatic, sound-activated, synchronized show. This function is ideal when you want to start a show immediately. Connect the DMX output of the master device to the DMX input of the first slave device. Then connect the DMX output of the first slave device to the DMX input of the second slave device and so on.



## 6 Connections and operating elements

### Rear panel

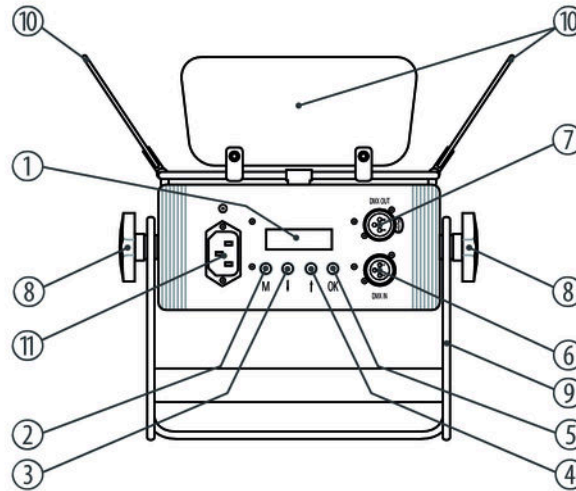

HL-x9 Quad Color HL-x9 W QCL RGBW HL-x9 W QCL RGB WW  
HL-x9 QCL RGB WW Flood 9x8W

1	Display.
2	<i>[M]</i> button Calls the main menu or a submenu.
3,4	↑, ↓ buttons. Increases / decreases the displayed value by one.
5	<i>[OK]</i> button Confirms a selected value.
6	<i>[DMX IN]</i> DMX input.
7	<i>[DMX OUT]</i> DMX output.
8	Locking screws for the mounting bracket.
9	Bracket for floor placement or hanging.

- |    |  |
|----|--|
| 10 | Barn doors.                                    |
| 11 | IEC chassis plug for operating voltage supply. |

HL-x9 Quad Color HL-x9 W QCL RGBW HL-x9 W QCL RGB WW  
HL-x9 QCL RGB WWFlood 9x8W

## 7 Operating

### 7.1 Starting up the device

Connect the unit to the power grid to start the operation. After a few seconds, the display shows a running reset. Then the unit is ready for use.

### 7.2 Main menu

Press *[M]* to activate the main menu and to select an operating mode. Use the arrow keys to change the respectively indicated value. When the display shows the desired value, press *[OK]*.

If you don't press any button for about 1 minute, the unit returns to the previous mode. The set values are retained even when the device is disconnected from the mains power.

**DMX mode**

Press *[M]*. Press one of the arrow keys repeatedly until the display shows 'SET'. Press *[OK]*. Press one of the arrow keys repeatedly until the display shows 'MODE'. Press *[OK]*. Now use the arrow keys to select one of the following DMX operating modes:

- '4CH' (four channels)
- '6CH' (six channels)
- '8CH' (eight channels)

This setting is only relevant if the unit is controlled via DMX. When the display shows the desired value, press *[OK]* to confirm the selection, and then *[M]* to return to the parent menu. To return to the parent menu without any changes, press *[M]*.

### DMX address

Press *[M]*. Press one of the arrow keys repeatedly until the display shows 'DMX'. Press *[OK]*. Now you can set the number of the first DMX channel to be used by the device (DMX address). Select a value between 1 and 512 with the arrow keys (display shows 'A001' ... 'A512').

When the display shows the desired value, press *[OK]* to confirm the selection, and then *[M]* to return to the parent menu. To return to the parent menu without any changes, press *[M]*.

Make sure that this number matches the configuration of your DMX controller. The following table shows the highest possible DMX address for the various DMX modes.

Mode	Highest possible DMX address
4-channel	509
6-channel	507
8-channel	505

**Operating mode 'Show/Master'**

Press *[M]*. Press one of the arrow keys repeatedly until the display shows 'LINE'. Press *[OK]*. Press one of the arrow keys repeatedly until the display shows 'MA'. Press *[OK]*. Now you can select one of the preprogrammed automatic shows. Use the arrow keys to select a value between 1 and 42 (display shows 'P-01' ... 'P-42').

The automatic show can only be activated on the unit, that operates as Master.

This setting is only relevant if the unit is not controlled via DMX. The device can work in stand-alone mode or control connected devices of the same type, which must be configured as slave. When the display shows the desired value, press *[OK]* to confirm the selection, and then *[M]* to return to the parent menu. To return to the parent menu without any changes, press *[M]*.

**Operating mode 'Slave'**

Press *[M]*. Press one of the arrow keys repeatedly until the display shows 'LINE'. Press *[OK]*. Press one of the arrow keys repeatedly until the display shows 'SL'. Press *[OK]*. Now you can set the number of the device through which it is addressed as Slave by the Master. Select a value between 1 and 512 with the arrow keys (display shows 'A001' ... 'A512').

This setting is only relevant if the unit works as slave controlled by a master, but not via DMX. When the display shows the desired value, press *[OK]* to confirm the selection, and then *[M]* to return to the parent menu. To return to the parent menu without any changes, press *[M]*.

### **Programme speed**

Press *[M]*. Press one of the arrow keys repeatedly until the display shows 'SET'. Press *[OK]*. Press one of the arrow keys repeatedly until the display shows 'SPEE'. Press *[OK]*. Now you can set the programme speed for the preprogrammed automatic shows. Select a value between 0 and 255 (display shows 'T000' ... 'T255').

The programme speed can be set only if the microphone sensitivity is set to 'OFF', i.e. the microphone is switched off.

This setting is only relevant if the unit is not controlled via DMX. When the display shows the desired value, press *[OK]* to confirm the selection, and then *[M]* to return to the parent menu. To return to the parent menu without any changes, press *[M]*.

### **Brightness**

Press *[M]*. Press one of the arrow keys repeatedly until the display shows 'SET'. Press *[OK]*. Press one of the arrow keys repeatedly until the display shows 'DIMM'. Press *[OK]*. Now you can set the brightness for the preprogrammed automatic shows. Use the arrow keys to select a value between 0 and 255 (display shows 'D000' ... 'D255').

This setting is only relevant if the unit is not controlled via DMX. When the display shows the desired value, press *[OK]* to confirm the selection, and then *[M]* to return to the parent menu. To return to the parent menu without any changes, press *[M]*.



### Microphone sensitivity

Press *[M]*. Press one of the arrow keys repeatedly until the display shows 'SET'. Press *[OK]*. Press one of the arrow keys repeatedly until the display shows 'MIC'. Press *[OK]*. Now you can adjust the sensitivity of the built-in microphone for the sound control. Use the arrow keys to select either 'OFF' (microphone off) or a value between 1 and 30 (display shows 'M-01' ... 'M-30').

This setting is only relevant if the unit is not controlled via DMX. When the display shows the desired value, press *[OK]* to confirm the selection, and then *[M]* to return to the parent menu. To return to the parent menu without any changes, press *[M]*.

### Manual test

Press *[M]*. Press one of the arrow keys repeatedly until the display shows 'TEST'. Press *[OK]*. Press one of the arrow keys repeatedly until the display shows 'RED', 'GREE', 'BLUE', 'WHIT' or 'STRO'. Press *[OK]*. Now you can adjust the brightness of the red, green, blue or white LEDs, each in a range of 0 to 255, or select the flashing speed in a range of 0 to 24.

This operation mode is also suitable to produce constant or flashing light of a colour mixed from the four LED colours without DMX control.

When the display shows the desired value, press *[OK]* to confirm the selection, and then *[M]* to return to the parent menu. To return to the parent menu without any changes, press *[M]*.

### **Fade speed**

Press *[M]*. Press one of the arrow keys repeatedly until the display shows 'FADE'. Press *[OK]*. Now you can adjust the fade speed of the preprogrammed automatic shows. Select a value between 1 and 7 with the arrow keys (display shows 'F-01' ... 'F-07').

This setting is only relevant if the unit is not controlled via DMX. When the display shows the desired value, press *[OK]* to confirm the selection and to return to the main menu. To return to the main menu without any changes, press *[M]*.

### **Colour selection**

Press *[M]*. Press one of the arrow keys repeatedly until the display shows 'COLO'. Press *[OK]*. Now you can set the a basic colour for the preprogrammed automatic shows. Select a value between 1 and 4 with the arrow keys (display shows 'C-01' ... 'C-04').

This setting is only relevant if the unit is not controlled via DMX. When the display shows the desired value, press *[OK]* to confirm the selection and to return to the main menu. To return to the main menu without any changes, press *[M]*.

### 7.3 Menu overview

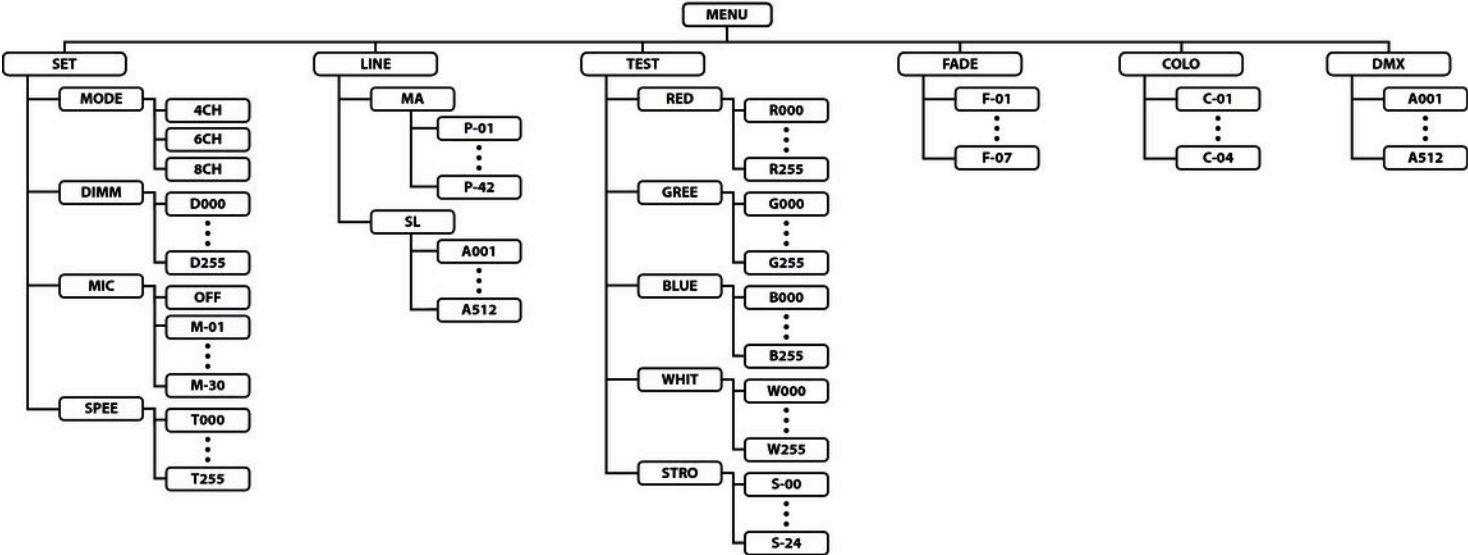

HL-x9 Quad Color HL-x9 W QCL RGBW HL-x9 W QCL RGB WW  
HL-x9 QCL RGB WWFlood 9x8W

## 7.4 Functions in 4-channel DMX mode

Channel	Value	Function
1	0...255	Intensity red (0 % to 100 %)
2	0...255	Intensity green (0 % to 100 %)
3	0...255	Intensity blue (0 % to 100 %)
4	0...255	Intensity white (0 % to 100 %)

## 7.5 Functions in 6-channel DMX mode

Channel	Value	Function
1	Operating mode selection	
	0...63	Constant colour, colour hue is set via channels 2 to 5
	64...127	Automatic colour change with 7 colours, channels 2 to 5 without function

Channel	Value	Function
	128...191	Automatic colour change with 12 colours, channels 2 to 5 without function
	192...255	Automatic colour change with 4 colours, channels 2 to 5 without function
2	0...255	Intensity red (0 % to 100 %), if channel 1 = 0...63
3	0...255	Intensity green (0 % to 100 %), if channel 1 = 0...63
4	0...255	Intensity blue (0 % to 100 %), if channel 1 = 0...63
5	0...255	Intensity white (0 % to 100 %), if channel 1 = 0...63
6	Effects speed	
	0...10	No automatic colour change
	11...100	Automatic colour change as set via channel 1, decreasing speed from fast to slow
	101...150	No automatic colour change
	151...255	Automatic colour change as set via channel 1, speed randomly changing

HL-x9 Quad Color HL-x9 W QCL RGBW HL-x9 W QCL RGB WW  
HL-x9 QCL RGB WWFlood 9x8W

## 7.6 Functions in 8-channel DMX mode

Channel	Value	Function
1	0...255	Intensity Red (0 % to 100 %), if channel 5 = 0...15 and channel 7 = 0...31
2	0...255	Intensity Green (0 % to 100 %), if channel 5 = 0...15 and channel 7 = 0...31
3	0...255	Intensity Blue (0 % to 100 %), if channel 5 = 0...15 and channel 7 = 0...31
4	0...255	Intensity White (0 % to 100 %), if channel 5 = 0...15 and channel 7 = 0...31
5	Fixed colour pattern	
	0...15	No fixed colour and movement pattern
	16...255	One of 31 fixed colour patterns, channels 6 and 7 without function
6	Strobe effect	
	0...15	Full brightness, no strobe effect
	16...255	Strobe effect, increasing speed, if channel 5 = 0...15
7	Operating mode selection	

Channel	Value	Function
	0...31	Constant colour, the hue is set by channels 1 to 4
	32...63	Fade-out effect, speed controlled by channel 6, channels 1 to 4 define the colour
	64...95	Fade-in effect, speed controlled by channel 6, channels 1 to 4 define the colour
	96...127	Fade-in-out effect, speed controlled by channel 6, channels 1 to 4 define the colour
	128...159	Auto-mix effect, speed controlled by channel 6, channels 1 to 5 without function
	160...191	Chase (4 colours), speed controlled by channel 6, channels 1 to 5 without function
	192...223	Chase (12 colours), speed controlled by channel 6, channels 1 to 5 without function
	224...255	Sound-controlled colour change, increasing microphone sensitivity
8	0...255	Dimmer (0 % to 100 %)

HL-x9 Quad Color HL-x9 W QCL RGBW HL-x9 W QCL RGB WW  
HL-x9 QCL RGB WWFlood 9x8W

## 8 Technical specifications

Light source	9 × 4in1 LED, 8 W each	
	HL-x9 Quad Color (item no. 288505): red, green, blue, white	
	HL-x9 W QCL RGBW (item no. 418753): red, green, blue, white	
	HL-x9 W QCL RGB WW (item no. 418758): red, green, blue, warm white	
	HL-x9 QCL RGB WW (item no. 418760): red, green, blue, warm white	
Optical properties	Beam angle	ca. 35°
Control		DMX
		Buttons and display
Number of DMX channels		4, 6, 8
Input connections	Voltage supply	IEC chassis plug C14
	DMX control	XLR chassis socket, 3-pin



Output connections	DMX control	XLR chassis socket, 3-pin
Power consumption		76 W
Supply voltage		110 – 230 V ~ 50/60 Hz
Degree of protection		IP20
Mounting options		Hanging, standing
Dimensions (W xH xD), without bracket and barn doors		300 mm x 125 mm x 165 mm
Height with barn doors		385 mm
Weight		4.3 kg
Ambient conditions	Temperature range	0 °C...40 °C
	Relative humidity	50 %, non-condensing

HL-x9 Quad Color HL-x9 W QCL RGBW HL-x9 W QCL RGB WW  
HL-x9 QCL RGB WWFlood 9x8W

### Further information

Outdoor-ready	No
Colour mixture	RGBW
LED type	x-in-1
Base housing	Yes
Fanless	No
Remote control	Not possible
Wireless DMX	No
Housing colour	Black

# 9 Plug and connection assignments

## Introduction

This chapter will help you select the right cables and plugs to connect your valuable equipment so that a perfect light experience is guaranteed.

Please take our tips, because especially in 'Sound & Light' caution is indicated: Even if a plug fits into a socket, the result of an incorrect connection may be a destroyed DMX controller, a short circuit or 'just' a not working light show!

## DMX connections



The unit offers a 3-pin XLR socket for DMX output and a 3-pin XLR plug for DMX input. Please refer to the drawing and table below for the pin assignment of a suitable XLR plug.

Pin	Configuration
1	Ground, shielding
2	Signal inverted (DMX-, 'cold signal')
3	Signal (DMX+, 'hot signal')

HL-x9 Quad Color HL-x9 W QCL RGBW HL-x9 W QCL RGB WW  
HL-x9 QCL RGB WWFlood 9x8W

## 10 Troubleshooting



### **NOTICE!**

#### **Possible data transmission errors**

For error-free operation make use of dedicated DMX cables and do not use ordinary microphone cables.

Never connect the DMX input or output to audio devices such as mixers or amplifiers.

In the following we list a few common problems that may occur during operation. We give you some suggestions for easy troubleshooting:

Symptom	Remedy
The unit does not work, no light.	Check the mains connection and the fuse.
No response to the DMX controller.	1. Check the DMX ports and cables for proper connection.
	2. Check the address settings and the DMX polarity.
	3. Try using another DMX controller.
	4. Check to see if the DMX cables run near or alongside to high voltage cables that may cause damage or interference to DMX interface circuits.

If the procedures recommended above do not succeed, please contact our Service Center. You can find the contact information at [www.thomann.de](http://www.thomann.de).

## 11 Cleaning

### Optical lenses

Clean the optical lenses, that are accessible from the outside, regularly in order to optimize the light output. The frequency of cleaning depends on the operating environment: wet, smoky or particularly dirty surroundings can cause more accumulation of dirt on the optics of the device.

- Clean with a soft cloth using our lamp and lens cleaner (item no. 280122).
- Always dry the parts carefully.

### Fan grids

The fan grids of the device must be cleaned of any contamination, such as dust, etc. on a regular basis. Before cleaning, switch off the device and disconnect mains-operated devices from the mains. Only use pH-neutral, solvent-free and non-abrasive cleaning agents. Clean the unit with a slightly damp lint-free cloth.

## 12 Protecting the environment

### Disposal of the packaging material



For the transport and protective packaging, environmentally friendly materials have been chosen that can be supplied to normal recycling.

Ensure that plastic bags, packaging, etc. are properly disposed of.

Do not just dispose of these materials with your normal household waste, but make sure that they are collected for recycling. Please follow the notes and markings on the packaging.

### Disposal of your old device



This product is subject to the European Waste Electrical and Electronic Equipment Directive (WEEE) in its currently valid version. Do not dispose with your normal household waste.

Dispose of this device through an approved waste disposal firm or through your local waste facility. When discarding the device, comply with the rules and regulations that apply in your country. If in doubt, consult your local waste disposal facility.

HL-x9 Quad Color HL-x9 W QCL RGBW HL-x9 W QCL RGB WW  
HL-x9 QCL RGB WW Flood 9x8W





HL-x9 Quad Color HL-x9 W QCL RGBW HL-x9 W QCL RGB WW  
HL-x9 QCL RGB WWFlood 9x8W





