

th•mann

SP-120 digital piano



Thomann GmbH
Hans-Thomann-Straße 1
96138 Burgebrach
Germany
Telephone: +49 (0) 9546 9223-0
Internet: www.thomann.de

21.02.2022, ID: 482377

Table of contents

1	General information	4
	1.1 Further information.....	4
	1.2 Notational conventions.....	4
	1.3 Symbols and signal words.....	5
2	Safety instructions	6
3	Features	8
4	Installation	9
5	Connection options	12
6	Control panel and connections	13
7	Operating	15
	7.1 Turning on / off.....	15
	7.2 Automatic shutoff.....	15
	7.3 Adjusting the volume.....	15
	7.4 Setting the touch sensitivity.....	15
	7.5 Master Tuning / MIDI functions.....	16
	7.5.1 Master Tuning.....	16
	7.5.2 MIDI functions.....	16
	7.5.3 MIDI panic button.....	17
	7.5.4 Local On / Off.....	17
	7.5.5 Reset to factory defaults.....	18
8	Functions	19
	8.1 Selecting voices.....	19
	8.2 Playing demo songs.....	19
	8.3 Digital effects.....	20
	8.3.1 Reverb and Chorus effects.....	20
	8.3.2 Equalizer.....	21
	8.4 Metronome.....	21
	8.5 Transposing.....	22
	8.6 Layer mode.....	23
9	Troubleshooting	25
10	Technical specifications	26
11	MIDI implementation chart	28
12	Function button allocation	30
13	Protecting the environment	33

1 General information

This user manual contains important information on the safe operation of the device. Read and follow all safety notes and all instructions. Save this manual for future reference. Make sure that it is available to all persons using this device. If you sell the device to another user, be sure that they also receive this manual.

Our products and user manuals are subject to a process of continuous development. We therefore reserve the right to make changes without notice. Please refer to the latest version of the user manual which is ready for download under www.thomann.de.

1.1 Further information

On our website (www.thomann.de) you will find lots of further information and details on the following points:

Download	This manual is also available as PDF file for you to download.
Keyword search	Use the search function in the electronic version to find the topics of interest for you quickly.
Online guides	Our online guides provide detailed information on technical basics and terms.
Personal consultation	For personal consultation please contact our technical hotline.
Service	If you have any problems with the device the customer service will gladly assist you.

1.2 Notational conventions

This manual uses the following notational conventions:

Letterings

The letterings for connectors and controls are marked by square brackets and italics.

Examples: *[VOLUME]* control, *[Mono]* button.

Displays

Texts and values displayed on the device are marked by quotation marks and italics.

Examples: '24ch', 'OFF'.

Instructions

The individual steps of an instruction are numbered consecutively. The result of a step is indented and highlighted by an arrow.

Example:

1. ➤ Switch on the device.
2. ➤ Press *[Auto]*.
⇒ Automatic operation is started.
3. ➤ Switch off the device.

1.3 Symbols and signal words

In this section you will find an overview of the meaning of symbols and signal words that are used in this manual.

Signal word	Meaning
DANGER!	This combination of symbol and signal word indicates an immediate dangerous situation that will result in death or serious injury if it is not avoided.
CAUTION!	This combination of symbol and signal word indicates a possible dangerous situation that can result in minor injury if it is not avoided.
NOTICE!	This combination of symbol and signal word indicates a possible dangerous situation that can result in material and environmental damage if it is not avoided.
Warning signs	Type of danger
	Warning – danger zone.

2 Safety instructions

Intended use

This device is intended to be used for electronic sound generation using a piano keyboard. Use the device only as described in this user manual. Any other use or use under other operating conditions is considered to be improper and may result in personal injury or property damage. No liability will be assumed for damages resulting from improper use.

This device may be used only by persons with sufficient physical, sensorial, and intellectual abilities and having corresponding knowledge and experience. Other persons may use this device only if they are supervised or instructed by a person who is responsible for their safety.

Safety



DANGER!

Danger for children

Ensure that plastic bags, packaging, etc. are disposed of properly and are not within reach of babies and young children. Choking hazard! Ensure that children do not detach any small parts (e.g. knobs or the like) from the unit. They could swallow the pieces and choke! Never let children unattended use electrical devices.



CAUTION!

Possible hearing damage

With loudspeakers or headphones connected, the device can produce volume levels that may cause temporary or permanent hearing impairment. Do not operate the device permanently at a high volume level. Decrease the volume level immediately if you experience ringing in your ears or hearing impairment.



NOTICE!

Operating conditions

This device has been designed for indoor use only. To prevent damage, never expose the device to any liquid or moisture. Avoid direct sunlight, heavy dirt, and strong vibrations. Only operate the device within the ambient conditions specified in the chapter 'Technical specifications' of this user manual. Avoid heavy temperature fluctuations and do not switch the device on immediately after it was exposed to temperature fluctuations (for example after transport at low outside temperatures). Dust and dirt inside can damage the unit. When operated in harmful ambient conditions (dust, smoke, nicotine, fog, etc.), the unit should be maintained by qualified service personnel at regular intervals to prevent overheating and other malfunction.



NOTICE!

External power supply

The device is powered by an external power supply. Before connecting the external power supply, ensure that the input voltage (AC outlet) matches the voltage rating of the device and that the AC outlet is protected by a residual current circuit breaker. Failure to do so could result in damage to the device and possibly the user. Unplug the external power supply before electrical storms occur and when the device is unused for long periods of time to reduce the risk of electric shock or fire.



NOTICE!

Risk of fire due to incorrect polarity

Incorrectly inserted batteries may destroy the device or the batteries. Ensure that proper polarity is observed when inserting batteries.



NOTICE!

Possible damage by leaking batteries

Leaking batteries can cause permanent damage to the device. Take batteries out of the device if it is not going to be used for a longer period.

- !** **NOTICE!**
Possible staining
- The plasticiser contained in the rubber feet of this product may possibly react with the coating of your surface and after some time cause permanent dark stains. In case of doubt, do not put the rubber feet directly on the surface and use a suitable underlay if necessary, i.e. felt-pad floor protectors or similar.

- !** **NOTICE!**
Use of stands
- When mounting the device onto a stand, ensure that the stand is in a safe and stable position and that the weight of the device does not exceed the maximum permissible load capacity of the stand.

3 Features

The digital piano is characterized by the following features:

- 73 light weighted keys
- 12 selectable timbres
- Polyphony: 32-voice
- Layer mode
- Reverb and Chorus effects
- Integrated metronome
- 12 Demo songs, playback tempo adjustable
- Connections: Headphones, USB to host (MIDI / audio), LINE OUT (L / R), sustain pedal
- Power supply: Via the supplied power adapter or with 6 D-cells (LR20, 1.5 V)
- Operating system: Windows® 8 and later, Mac OS X® 10.8 and later

4 Installation

Mains connection

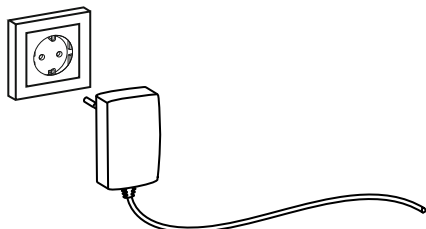

1. ➤ Make sure that the device is turned off before you connect it to the power supply or disconnect it.
2. ➤ Turn the volume control to minimum.
3. ➤ Connect the included power adapter to the 12V connector of the unit and then plug the power adapter into a wall outlet.
4. ➤ Now you can turn on the device.



If the piano is not in use or when a thunderstorm with danger of lightning threatens, disconnect the device from its mains power for safety.

Battery operation



NOTICE!

Risk of fire due to incorrect polarity

Incorrectly inserted batteries may destroy the device or the batteries.
Ensure that proper polarity is observed when inserting batteries.



NOTICE!

Possible damage by leaking batteries

Leaking batteries can cause permanent damage to the device.
Take batteries out of the device if it is not going to be used for a longer period.

Assembly overview

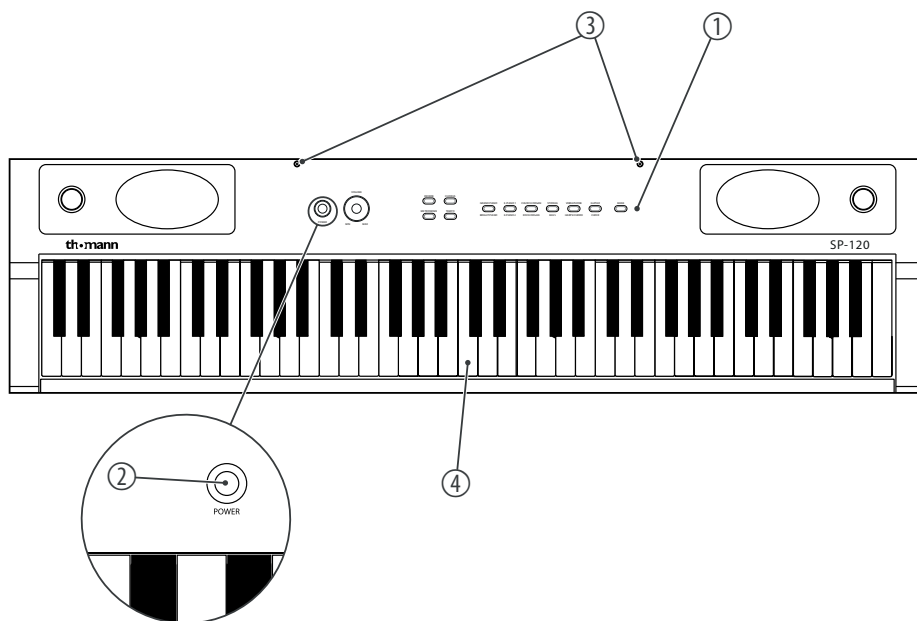

1	Control panel
2	Main switch
3	Holes for music stand
4	Claviature

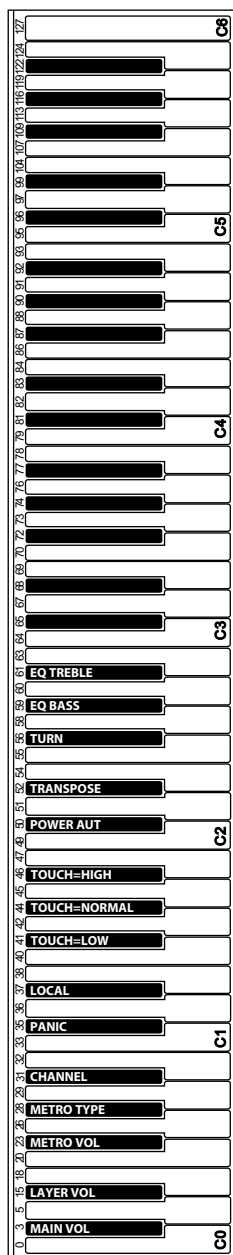

5 Connection options

Headphones

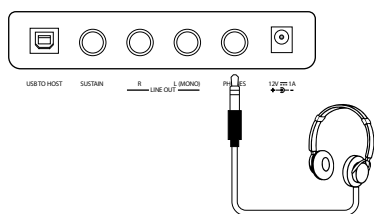

The headphones output is located on the rear side of the device.

Connecting headphones (not supplied) to the headphones output mutes the speakers.

Pedal

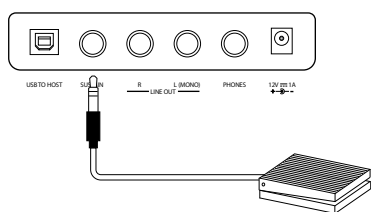

Connect the supplied Sustain pedal to the provided connector on the rear side of the device.

Pedal functions: With the sustain pedal all played notes sound longer. This effect simulates the lifting of the damper in an analogue keyboard instrument.

USB to host

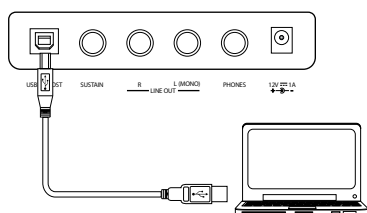

Via this output, the MIDI data generated by the digital piano are transferred to a PC (MIDI stands for 'Musical Instrument Digital Interface' and enables the electronic interaction of various instruments and sound modules as a worldwide standard).

At the same time, the audio signal from the digital piano is transmitted to a connected PC via this output and can be recorded and reproduced using appropriate software.



Use a current operating system still supported by the provider to avoid technical difficulties.

External audio devices Line Out (L / R)

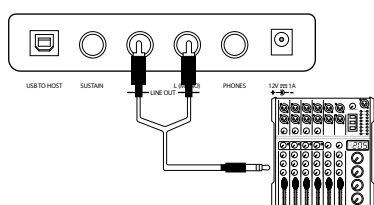

Use the [LINE OUT] sockets to connect the digital piano to an amplifier, stereo device, mixing console or recording device. Plug one end of the audio cable into the [LINE OUT] sockets in the connection box of the digital piano and the other end into the input of the respective audio device.



NOTICE!

To prevent damage to the speakers, turn the volume down to 'Minimum' before you connect other devices to the digital piano.

6 Control panel and connections

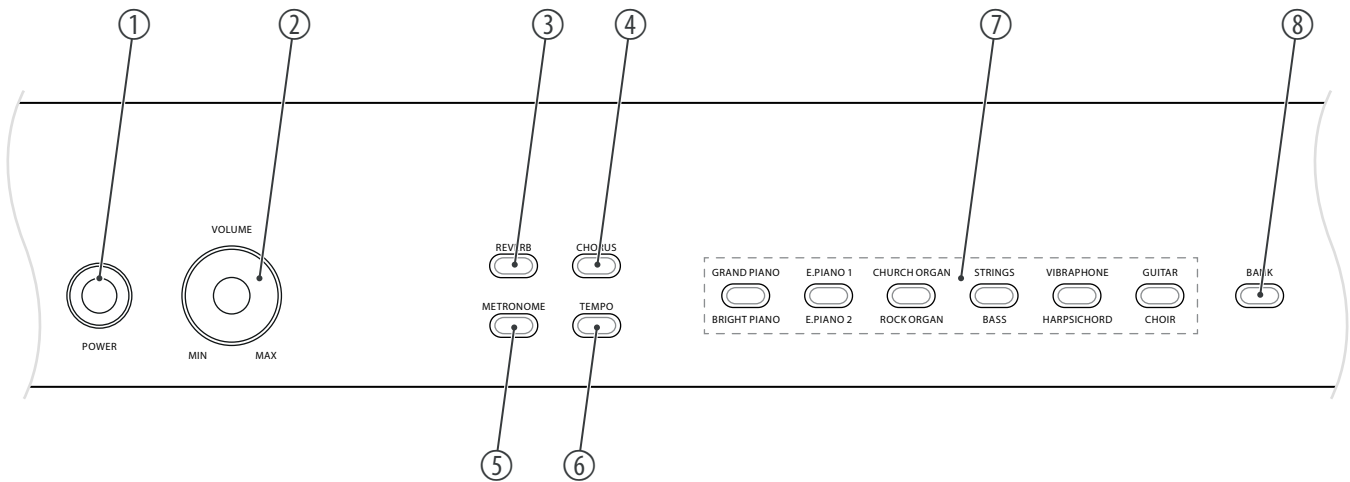

1	[POWER] Main switch. Turns the device on and off.
2	[VOLUME] Volume control for the built-in speakers and connected headphones
3	[REVERB] Button to engage the Reverb effect
4	[CHORUS] Button to engage the Chorus effect
5	[METRONOME] Button to turn the metronome on and off
6	[TEMPO] Button to adjust the metronome tempo
7	Voice selection buttons
	[GRAND PIANO / BRIGHT PIANO] Voice selection button Grand Piano / Bright Piano
	[E.PIANO 1 / E.PIANO 2] Voice selection button EPIANO1 and EPIANO2
	[CHURCH ORGAN/ROCK ORGAN] Voice selection button Church Organ / Rock Organ
	[STRINGS/BASS] Voice selection button Strings / Bass

3. ➤ The device automatically exits the edit mode.
 - ⇒ The LED of the button lights up.

Setting	Meaning
'F#1'	Soft (0...30) In this setting, the volume is lower than usual even when playing with a hard touch.
'G#1'	Normal (31...70) This setting corresponds to the usual touch response of a keyboard (factory default setting).
'A#1'	Hard (71...127) In this setting, the volume is higher than usual even when playing with a soft touch.

7.5 Master Tuning / MIDI functions

Press and hold *[METRONOME]* and *[TEMPO]* simultaneously to enter Edit mode. Here you can customize various parameters of the digital piano.

7.5.1 Master Tuning

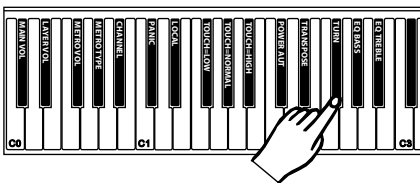

The piano is tuned to 440 Hz by default. That's why the piano does not need to be tuned after turning on. If desired, the tuning of the piano can be adjusted in small increments -50 and +50 (one semitone).

1. ➤ Press and hold *[METRONOME]* and *[TEMPO]* simultaneously to enter Edit mode.
2. ➤ Use *[F#2]* to tune the piano in semitone increment.
3. ➤ Use *[METRONOME]* and *[TEMPO]* to exit the Edit mode.

7.5.2 MIDI functions

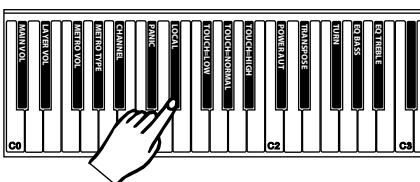

With this function you can activate the MIDI output of the digital piano. The MIDI out channels range from 1 to 16. Press and hold *[METRONOME]* and *[TEMPO]* simultaneously to enter Edit mode.

To change the value of the MIDI OUT channel, proceed as follows:

1. ➤ Press *[A#0]* according to the value of the desired MIDI out channel.
2. ➤ The number of hits on *[C3]* sets the value of the MIDI out channel. The default MIDI out channel is set to 1. Press *[A#0]* once in Edit mode. To confirm that the MIDI out channel is set to 1, the tone C3 is reproduced once.
3. ➤ Example: Pressing key *[A#0]* nine times will play the tone C3 ten times. This confirms that the MIDI out channel value has been set to 10.

7.5.3 MIDI panic button

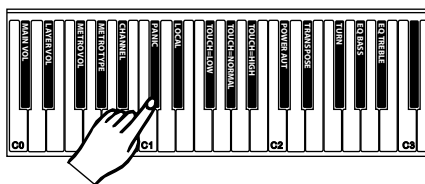

Pressing the Panic button sends the commands 'Reset all controllers' and 'All sounds off' as a MIDI message to all MIDI channels from 1 – 16.



This function can particularly be used when notes 'hang' in external MIDI devices or MIDI software.

1. ➤ Press and hold [METRONOME] and [TEMPO] simultaneously to enter Edit mode.
2. ➤ Then press [C#1] to activate the Panic function. This sends general programme commands to reset the MIDI functions, like 'All notes off', etc.
3. ➤ When the panic reset is finished, the piano automatically returns to play mode.

7.5.4 Local On / Off

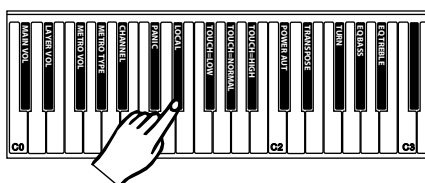

The Local On / Off function disconnects the keyboard from its internal sound system. This allows you to use the piano as a MIDI controller for other MIDI devices (or for virtual software instruments running on your computer). If you are running MIDI sequencing software, it is also recommended to run it in Local Off mode.

1. ➤ Press and hold [METRONOME] and [TEMPO] simultaneously to enter Edit mode.
2. ➤ Press [D#1] for Local On / Off
 - 'Local: ON' – built-in sound system activated (single key touch sound).
 - 'Local: OFF' – built-in sound system deactivated (double key touch sound).
3. ➤ Press and hold [METRONOME] and [TEMPO] simultaneously to exit the Edit mode.



When switching off the built-in sound system, the speakers as well as the line and headphones output are switched off.

7.5.5 Reset to factory defaults

Resetting to factory defaults clears the battery-powered memory and resets all functions to the factory defaults, as they existed on delivery. To reset the piano to factory defaults, proceed as follows:

1. ▶ Switch off the device.
2. ▶ Press and hold *[REVERB]* and *[CHORUS]* simultaneously and turn the piano on.
 - ⇒ All select button LEDs will now light up briefly when you hold down the two buttons. Once this is done, you can release *[REVERB]* and *[CHORUS]*. The piano is now in normal mode and ready to play. The LEDs on the control elements now show the original status according to the factory setting.

8 Functions

8.1 Selecting voices

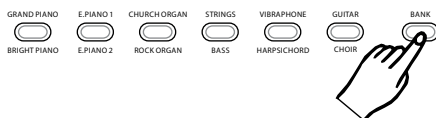

The digital piano offers 12 built-in voices.

1. ▶ Press one of the selection buttons to select the desired voice.
2. ▶ To select the second voice that is stored on the selection button, first press **[BANK]**.
 - ⇒ The LED of the button lights up.
3. ▶ Press one of the selection buttons again to select the voice in the second row.

8.2 Playing demo songs

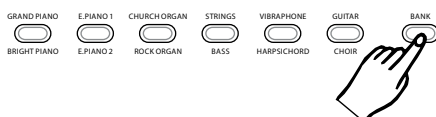

The digital piano offers 12 built-in demo track.

1. ▶ Press and hold **[REVERB]** and **[CHORUS]** simultaneously to enter Demo song play mode. The demo track "Piano" is selected by default.
 - ⇒ The LEDs of the **[REVERB]**, **[CHORUS]** and **[GRAND PIANO]/[BRIGHT PIANO]** buttons flash.
2. ▶ Press one of the selection buttons to select the desired demo track.
3. ▶ To select the second demo track that is stored on the selection button, first press **[BANK]**.
 - ⇒ The LED of the button lights up.
4. ▶ Press one of the selection buttons again to select the demo track in the second row.
5. ▶ Press **[REVERB]** and **[CHORUS]** again simultaneously to stop playback.

8.3 Digital effects

8.3.1 Reverb and Chorus effects

The sound of the digital piano can be modified by the built-in Reverb and Chorus effect. The effects are retained even if the device is switched off.

- 1.** ➤ Press *[REVERB]* or *[CHORUS]* to switch to the Edit mode.
⇒ The LED of the button lights up.
- 2.** ➤ To adjust the intensity of the effects, press and hold *[REVERB]* or *[CHORUS]*.
⇒ The LED of the button flashes.
- 3.** ➤ Now select a piano key that corresponds to the desired intensity of the effect. (see 📖 *Chapter 12 'Function button allocation' on page 30*).



You can press various piano keys repeatedly until the desired effect intensity is achieved.

- 4.** ➤ Press again *[REVERB]* or *[CHORUS]* to exit the edit mode.

8.3.2 Equalizer

The sound of the amplifier of the digital piano can be influenced with the built-in equalizer. The effects are retained even if the device is switched off.

To adjust the bass proceed as follows:

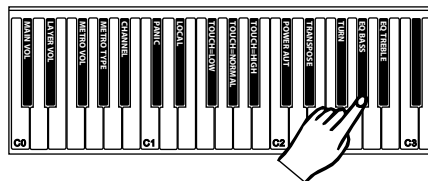

1. Press and hold [METRONOME] and [TEMPO] simultaneously to switch to Edit mode.

⇒ The LEDs of the buttons [METRONOME] and [TEMPO] light up.

2. Press the [G#2] key to switch to the EQ setup menu.

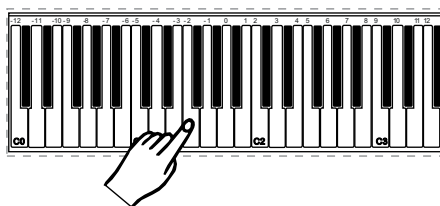

3. Now select one of the white keys of the keyboard [C0]...[F3] to adjust the bass (see Chapter 12 'Function button allocation' on page 30).

4. Press and hold [METRONOME] and [TEMPO] again simultaneously to exit the Edit mode.

To adjust the treble proceed as follows:

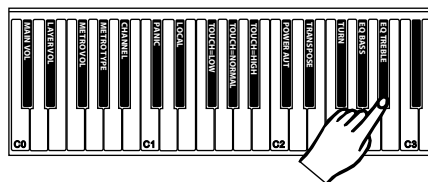

1. Press and hold [METRONOME] and [TEMPO] simultaneously to switch to Edit mode.

⇒ The LEDs of the buttons [METRONOME] and [TEMPO] light up.

2. Press the [G#2] key to switch to the EQ setup menu.

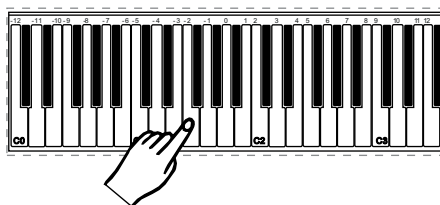

3. Now select one of the white keys of the keyboard [C0]...[F3] to adjust the treble (see Chapter 12 'Function button allocation' on page 30).

4. Press and hold [METRONOME] and [TEMPO] again simultaneously to exit the Edit mode.

8.4 Metronome

Press [METRONOME] to turn the Metronome on and off.

Proceed as follows to set the time signature:

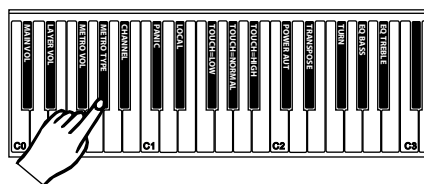

1. Press and hold [METRONOME] and [TEMPO] simultaneously to switch to Edit mode.

⇒ The LEDs of the buttons [METRONOME] and [TEMPO] light up.

2. Use the key [G#0] to select the desired time signature: 2/4, 3/4, 4/4, 5/4, 6/8, 9/8 or 12/8. Standard value is set to 4/4.

3. Press and hold [METRONOME] and [TEMPO] again simultaneously to exit the Edit mode.

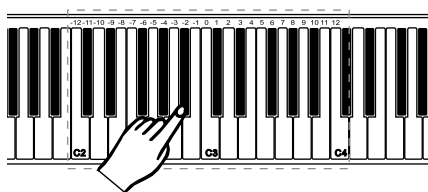

3. ➤ Use the keys [C2]...[C4] to transpose the value range. The default value is set according to the [C3] key (see [Chapter 12 'Function button allocation'](#) on page 30).
4. ➤ Press and hold [METRONOME] and [TEMPO] again simultaneously to exit the Edit mode.

8.6 Layer mode

In Layer mode, two voices can be played in parallel with the corresponding volume. Both can be selected with the direct select buttons.

Proceed as follows to adjust the Layer mode:

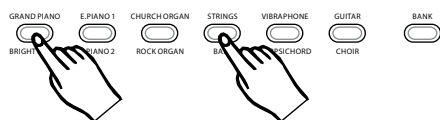

1. ➤ Press and hold the desired MAIN sound selection button (e.g. [GRAND PIANO]).
2. ➤ Then press a second desired selection button to set a layer effect (e.g. [STRINGS]). The LEDs of both selection buttons light up once you release the button.

To layer two sounds on different banks:

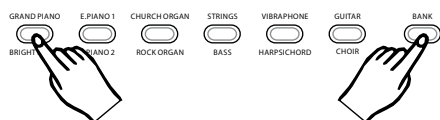

1. ➤ Press and hold the desired selection button (e.g. [GRAND PIANO]) and [BANK] at the same time.
 - ⇒ Once the [BANK] LED and the LED of the respective selection button light up, you can release the buttons.
2. ➤ Then press a second selection button (e.g. [STRINGS]) to get a layer effect on the second bank.
 - ⇒ The LEDs of both selection buttons light up.



If two voices are selected on the same key, the LED of this key flashes.

Adjusting the volume in the main layer (voice 1)

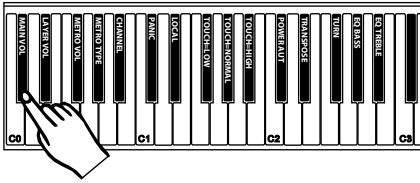

To adjust the main layer volume proceed as follows:

1. ➤ Keep *[METRONOME]* and *[TEMPO]* pressed to enter Edit mode.
⇒ The LEDs of the buttons *[METRONOME]* and *[TEMPO]* light up.
2. ➤ Press the key *[C#]* to switch to the volume menu for the main layer.
3. ➤ Now you can adjust the volume in 73 note steps from 0...127. *[C6]* corresponds to the value 127 and *[C0]* to the value 0 (see [Chapter 12 'Function button allocation'](#) on page 30).
4. ➤ Press and hold *[METRONOME]* and *[TEMPO]* again simultaneously to exit the Edit mode.

Adjusting the volume in the layer voice (voice 2)

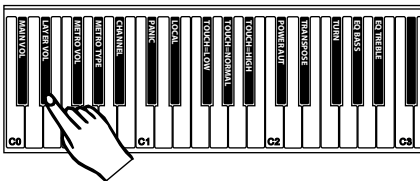

To adjust the layer voice volume proceed as follows:

1. ➤ Keep *[METRONOME]* and *[TEMPO]* pressed to enter Edit mode.
⇒ The LEDs of the buttons *[METRONOME]* and *[TEMPO]* light up now.
2. ➤ Press the key *[D#]* to switch to the tone colour volume menu.
3. ➤ Now you can adjust the volume in 73 note steps from 0...127. *[C6]* corresponds to the value 127 and *[C0]* to the value 0 (see [Chapter 12 'Function button allocation'](#) on page 30).
4. ➤ Press and hold *[METRONOME]* and *[TEMPO]* again simultaneously to exit the Edit mode.

9 Troubleshooting

Problem	Possible causes and solutions
You hear a 'pop' sound from the speakers when switching the digital piano on and off.	This is normal. No need to worry.
No sound can be heard when playing the piano.	<p>Make sure that the volume control is set appropriately.</p> <p>Check if headphones are connected. Connecting headphones will mute the speakers of the digital piano.</p> <p>Check in the function menu that the built-in sound system is activated. On activating, the display shows 'Local On'.</p>
Malfunction occurs when using a mobile phone.	Using a mobile phone near the digital piano can cause interference. To prevent this, turn off the mobile phone or use it only at a safe distance.

10 Technical specifications

Input connections	Voltage supply	Input socket for external power adapter
	USB port	USB-to-host
	Sustain pedal	1 × 1/4" jack socket
Output connections	Headphones	1 × 1/4" jack socket
	MIDI port	USB
	Line Out	2 × 1/4" jack socket
Keyboard	73 light weighted keys and adjustable touch velocity	
Polyphony	32-voice	
Tonal colours	12	
Effects	Reverb, Chorus, Equalizer	
Pedals	Sustain	
Demo and practice songs	12	
Operating system	Windows® 8 and later, Mac OS X® 10.8 and later	
Speaker	2 × 20 W, 8 Ω	
Power supply	External power adapter, 100 - 240 V ~ 50/60 Hz	
Operating voltage	12 V $\overline{\text{---}}$ / 1000 mA, centre positive	
Battery / rechargeable battery	Battery type	6 × D cells, LR20
	Voltage	1.5 V
Dimensions (W × H × D)	1070 mm × 95 mm × 275 mm	
Weight	6.2 kg	
Ambient conditions	Temperature range	0 °C...40 °C
	Relative humidity	20 %...80 % (non-condensing)

Further information

Colour	black
Surface	satined
Wooden keyboard	no
Ivory Feel keyboard	no
Auto Accompaniment	no
Number of rhythms	0
Hammer mechanism	no

Sequencer	no
Master keyboard functions	no
Pitch bend	no
Modulation wheel	no
Number of split zones	0
Layer function	yes

11 MIDI implementation chart

Function		Sent	Received	Notes
Basic Channel	Default	1 – 16	1 – 16	up to 3 channels at a time
	Changed	1 – 16	1 – 16	
Mode	Default	Mode 3	Mode 3	
	Messages	Yes	No	
	Altered	*****	No	
Note Number	True voice	0 – 127 *****	0 – 127	
Velocity Note	Note ON	Yes	Yes	
	Note OFF	Yes	Yes	
After Touch	Key's channels	No	No	
		No	No	
Pitch Bend		No	No	
Control Change		0 – 127	0,1,5,6,7,10,11, 32,64,65,66,67, 80,81,91,93,100, 101,121	
Programme Change	True #	0 – 127 *****	0 – 11	12
System Exclusive		Yes*	Yes*	*the controller detects and responds to the GM device requests. Master Tune supported. Master Volume supported.
System Common	Song Position Pointer	No	No	
	Song Select	No	No	
	Tune Request	No	No	
System Real Time	Clock	No	No	
	Commands	No	No	

Function		Sent	Received	Notes
Aux Messages	All Sounds Off*	Yes	Yes	*the controller responds to the GM signal, but not to the piano voices
	Reset All Controllers	Yes	Yes	
	Local ON/OFF*	Yes	Yes	
	ALL Notes OFF	Yes	Yes	
	Active Sensing	No	Yes	
	System Reset	No	Yes	
Notes:				

MIDI channel modes

	POLY OFF	MONO ON
OMNI ON	Mode 1	Mode 2
OMNI OFF	Mode 3	Mode 4

12 Function button allocation

Select the value to be parameterised using the following table:

	Tuning	Voice Vol	Layer Vol	Metro.Vol	Reverb Vol	Chorus Vol	Tempo	Treble EQ	Bass EQ	Trans.
C0	0	0	0	0	0	0	20	-12	-12	x
C#0	3	3	3	3	3	3	25	x	x	x
D0	5	5	5	5	5	5	30	-11	-11	x
D#0	15	15	15	15	15	15	35	-10	-10	x
E0	18	18	18	18	18	18	48	x	x	x
F0	20	20	20	20	20	20	52	-9	-9	x
F#0	23	23	23	23	23	23	56	x	x	x
G0	26	26	26	26	26	26	60	-8	-8	x
G#0	28	28	28	28	28	28	62	-7	-7	x
A0	29	29	29	29	29	29	64	x	x	x
A#0	31	31	31	31	31	31	66	-6	-6	x
B0	32	32	32	32	32	32	68	x	x	x
C1	33	33	33	33	33	33	70	-5	-5	x
C#1	35	35	35	35	35	35	72	x	x	x
D1	36	36	36	36	36	36	74	-4	-4	x
D#1	37	37	37	37	37	37	76	-3	-3	x
E1	38	38	38	38	38	38	80	x	x	x
F1	40	40	40	40	40	40	82	-2	-2	x
F#1	41	41	41	41	41	41	84	x	x	x
G1	42	42	42	42	42	42	86	-1	-1	x
G#1	44	44	44	44	44	44	88	0	0	x
A1	45	45	45	45	45	45	90	x	x	x
A#1	46	46	46	46	46	46	92	1	1	x
B1	47	47	47	47	47	47	94	x	x	x

	Tuning	Voice Vol	Layer Vol	Metro.Vol	Reverb Vol	Chorus Vol	Tempo	Treble EQ	Bass EQ	Trans.
C2	49	49	49	49	49	49	96	2	2	52
C#2	50	50	50	50	50	50	98	x	x	53
D2	51	51	51	51	51	51	100	3	3	54
D#2	52	52	52	52	52	52	102	4	4	55
E2	54	54	54	54	54	54	104	x	x	56
F2	55	55	55	55	55	55	106	5	5	57
F#2	56	56	56	56	56	56	108	x	x	58
G2	58	58	58	58	58	58	110	6	6	59
G#2	59	59	59	59	59	59	112	7	7	60
A2	60	60	60	60	60	60	114	x	x	61
A#2	61	61	61	61	61	61	116	8	8	62
B2	63	63	63	63	63	63	118	x	x	63
C3	64	64	64	64	64	64	120	9	9	64
C#3	65	65	65	65	65	65	122	x	x	65
D3	67	67	67	67	67	67	124	10	10	66
D#3	68	68	68	68	68	67	126	11	11	67
E3	69	69	69	69	69	69	128	x	x	68
F3	70	70	70	70	70	70	130	12	12	69
F#3	72	72	72	72	72	72	132	x	x	70
G3	73	73	73	73	73	73	134	x	x	71
G#3	74	74	74	74	74	74	136	x	x	72
A3	76	76	76	76	76	76	138	x	x	73
A#3	77	77	77	77	77	77	140	x	x	74
B3	78	78	78	78	78	78	142	x	x	75
C4	79	79	79	79	79	79	144	x	x	76
C#4	81	81	81	81	81	81	146	x	x	x
D4	82	82	82	82	82	82	148	x	x	x
D#4	83	83	83	83	83	83	150	x	x	x

Function button allocation

	Tuning	Voice Vol	Layer Vol	Metro. Vol	Reverb Vol	Chorus Vol	Tempo	Treble EQ	Bass EQ	Trans.
E4	84	84	84	84	84	84	152	×	×	×
F4	86	86	86	86	86	86	154	×	×	×
F#4	87	87	87	87	87	87	156	×	×	×
G4	88	88	88	88	88	88	158	×	×	×
G#4	90	90	90	90	90	90	160	×	×	×
A4	91	91	91	91	91	91	162	×	×	×
A#4	92	92	92	92	92	92	164	×	×	×
B4	93	93	93	93	93	93	166	×	×	×
C5	95	95	95	95	95	95	168	×	×	×
C#5	96	96	96	96	96	96	170	×	×	×
D5	97	97	97	97	97	97	172	×	×	×
D#5	99	99	99	99	99	99	174	×	×	×
E5	104	104	104	104	104	104	176	×	×	×
F5	107	107	107	107	107	107	190	×	×	×
F#5	109	109	109	109	109	109	200	x	×	×
G5	113	113	113	113	113	113	220	×	×	×
G#5	116	116	116	116	116	116	240	×	×	×
A5	119	119	119	119	119	119	260	×	×	×
A#5	122	122	122	122	122	122	270	×	×	×
B5	124	124	124	124	124	124	275	×	×	×
C6	127	127	127	127	127	127	280	×	×	×



For the fields marked with 'X', no value is assigned in the Edit mode.

Reset values (factory defaults)

	Tune	Voice Vol	Layer Vol	Metro. Vol	Local	Channel	Tempo	Voice Select	Trans	Auto Power Off
Factory defaults	0	127	100	100	ON	1	120	1 (Grand Piano)	0	OFF

13 Protecting the environment

Disposal of the packaging material



For the transport and protective packaging, environmentally friendly materials have been chosen that can be supplied to normal recycling.

Ensure that plastic bags, packaging, etc. are properly disposed of.

Do not just dispose these materials with your normal household waste, but make sure that they are fed to a recovery. Please follow the notes and markings on the packaging.

Disposal of batteries



Batteries must not be disposed of as domestic waste or thrown into fire. Dispose of the batteries according to national or local regulations regarding hazardous waste. To protect the environment, dispose of empty batteries at your retail store or at appropriate collection sites.

Disposal of your old device



This product is subject to the European Waste Electrical and Electronic Equipment Directive (WEEE) in its currently valid version. Do not dispose with your normal household waste.

Dispose this device through an approved waste disposal firm or through your local waste facility. When discarding the device, comply with the rules and regulations that apply in your country. If in doubt, consult your local waste disposal facility.

