

## SAMPLE SOUND SETTINGS

### ALLROUND

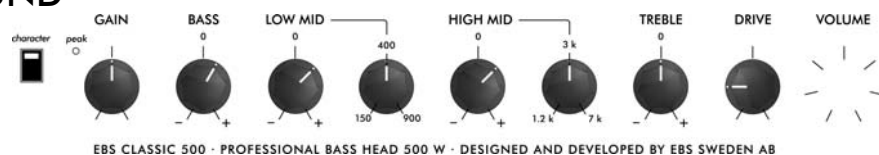

### HEAVY

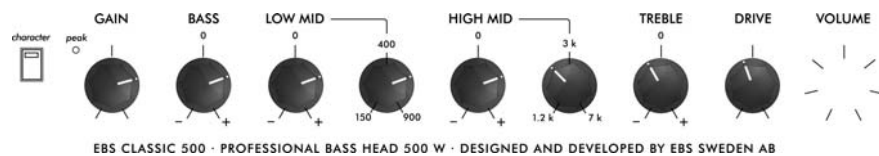

### ROCK

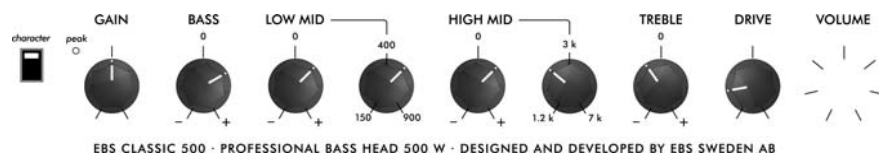

### FRETLESS

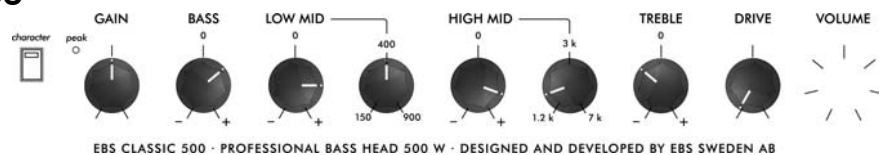

*Classical instruments together with the EBS-810 Classic cabinet were used when doing these settings  
Changes may be needed when using different instruments and cabinets.*

**Classic** LINE

DESIGNED AND DEVELOPED BY EBS SWEDEN AB

✉ GRINDSTUVÄGEN 44-46, SE-167 33 BROMMA, SWEDEN

☎ +46-8-735 00 10, FAX : +46-8-735 00 05



E-MAIL: [info@ebssweden.com](mailto:info@ebssweden.com)

WEB: [www.ebssweden.com](http://www.ebssweden.com)

June 2013

## USERS MANUAL

# EBS CLASSIC 500



CONTENTS:	PAGE:
INTRODUCTION	2
FRONT PANEL	3
FILTERS	4
REAR PANEL	5
BLOCK DIAGRAM	6
TECHNICAL SPECIFICATIONS	7
SAMPLE SOUND SETTINGS	8



The **EBS Classic 500** is a solid-state amplifier head, extremely easy to dial-in. It is designed to match the EBS ClassicLine cabinets in all styles and situations. The sound of the Classic 500 amp is a combination of vintage bass sound and the transparent 'EBS' sound that let your playing style and the character of your instrument speak. Versatility is provided by a carefully designed EQ section with very creative dual midrange sections. The boosted drive control adds everything from subtle, vintage overdrive to mean, crushing distortion – without loosing the low-end. These brief tutorials will help you to become acquainted with some of the features of the **EBS Classic 500**.

**GETTING STARTED...**

1. Carefully unpack the bass head.
2. Check that the Volume and Drive controls are set to zero, fully counter clockwise. Set all the other controls to mid position and make sure that the switch marked *Character* is in its' outer position. Now the EBS CL500's settings are "zeroed" and ready to be personalized.
3. Power up the head and plug in your bass.
4. While plucking the strings as hard as you would during your hardest playing, adjust the GAIN knob until the PEAK led starts to flash only at highest peaks.
5. Move over to the VOLUME knob and adjust for the desired output volume.

**BUILDING THE SOUND...**

Your **EBS Classic 500** features an enhanced tone shaping circuit that will enable you to create a variety of bass sounds.

6. The filters are basically the boost/cut design. This means that the level controls marked with + and - signs, either boost or cuts the selected frequency band. Further, the two MID sections have got frequency controls for precise adjustment of the midrange.
7. Gradually increase or decrease the level and vary the frequency of the various filter sections. Notice how the sound is affected.
8. Repeat as above by trying out the *preshape filter Character*.
9. Proceed to the Drive knob. This control adjusts the overdrive and can be seen as moderate up to 12 o'clock, after that point you could get highly distorted sounds.
10. For further reference, check out the sample sound setting on the last page of this manual.

This was a brief tutorial of **EBS Classic 500**. As you go on further in this manual, you will learn how to use and utilize all of the useful features that the **EBS Classic 500** offers you.

**GOOD LUCK!**

<b>INPUT:</b>	Input Impedance		1 Mohms // 100 pF
<b>GAIN:</b>	Gain Range	min/max	-∞/ +28 dB
	Gain Peak LED		+10 dBv
	Frequency Response	+0 / -3 dB	35 - 20k Hz
<b>CHARACTER:</b>	Filter:	Type	Shelving High/Low Pass
	Gain:		+6 dB @ 75 Hz -2.5 dB @ 800 Hz +3 dB @ 9 kHz
<b>FILTER SECTION:</b>	Bass Filter:	Type	12 dB/oct. Shelving
		Gain	+/- 15 dB @ 100 Hz
	Low Mid Filter:	Type	Bandpass Filter
		Range	150 – 900 Hz, Q=0.9
	Gain		+/- 15 dB
	High Mid Filter:	Type	Bandpass Filter
		Range	1.2 – 7 kHz, Q=1.1
		Gain	+/- 15 dB
	Treble Filter:	Type	Shelving
		Gain Range	+/- 15 dB @ 10 kHz
<b>DRIVE SECTION:</b>	Gain Range	min/max	0 / 30 dB
	Gain Type		Class A Tube Emulator
	Low End Compensation		< 250 Hz
<b>BALANCED OUTPUT:</b>	Output Level	nominal	- 10 dBv
	XLR Connections Options		1-GND, 2-Hot, 3-Cold Pre/Post Eq, GND Lift,
<b>LINE OUT:</b>	Output Impedance		< 5 kohms
	Nominal Signal Level		0 dBv
<b>POWER AMP:</b>	Continuous Output Power		440 W RMS @ 4 ohms 500 W RMS @ 2 ohms
	Protection		Thermal
<b>AUXILIARY INFO:</b>	Power Requirements	max	800 W
	Mains Protection:		T5A Fuse (230V) T10A Fuse (100/120V)
	Dimensions (WxDxH):		49 cm x 30 cm x 21,5 cm 19.3" x 11,8" x 8.5"
	Weight:		14 kg ( 31 lbs.)

*Specifications are subject to change without notice!*

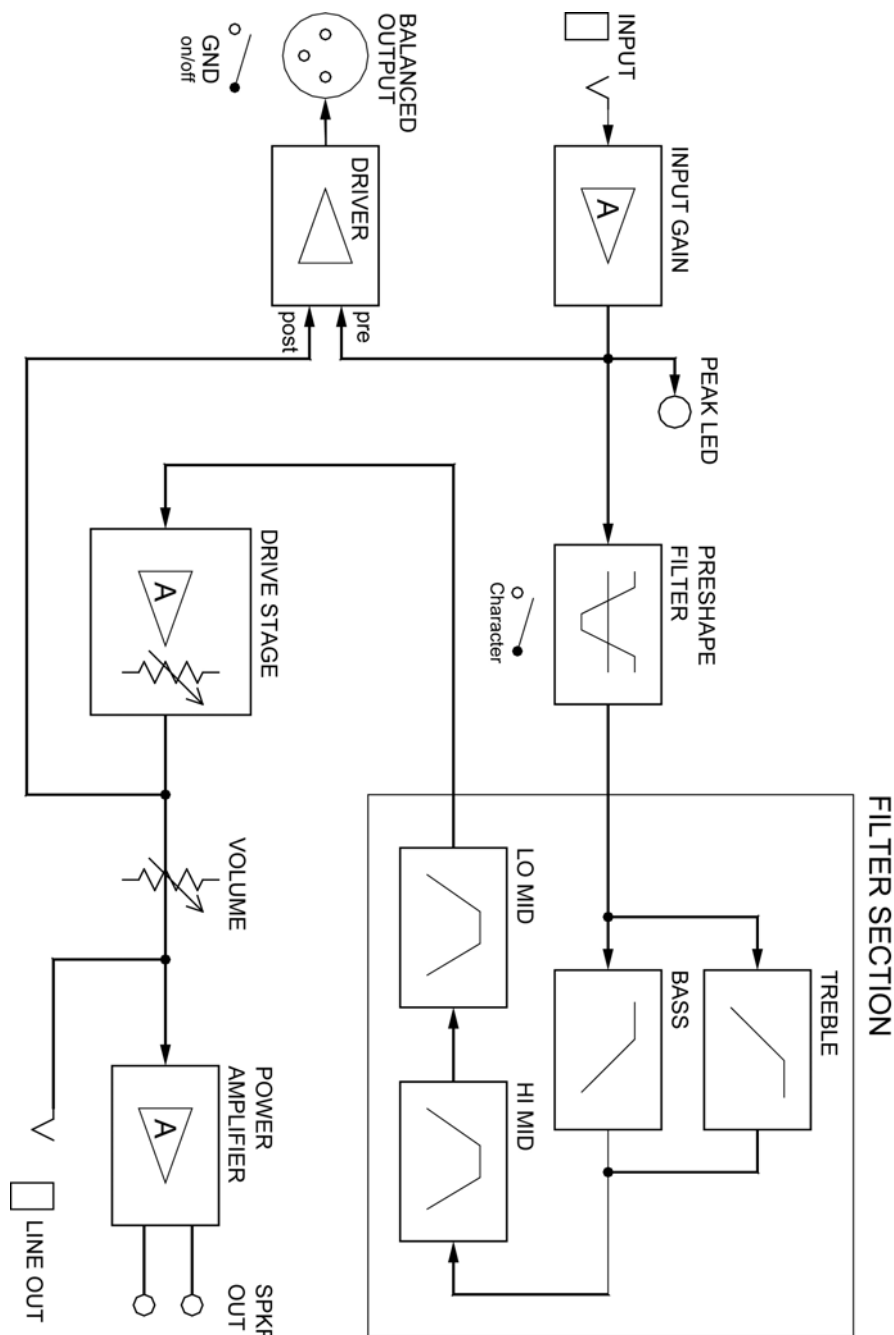

6

**INPUT** - A low noise, high impedance instrument input for all types of instruments, active and passive.

**CHARACTER** - The Classic 500 provides a *presaping* filter, *character*, which operates independently from the filter section. This gives the user the opportunity to preshape the sound before the final processing with the filters.

When pressed to its inner position, a boost is achieved in both the bass and treble ranges, while the midrange is being slightly cut.

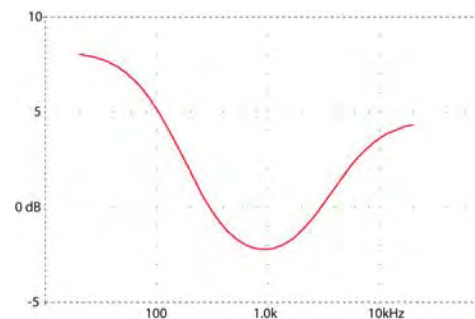

**GAIN** - Control to adjust the instruments' signal strength to the right operating level in the Classic 500.

For optimum basic signal level, turn up the GAIN knob until the PEAK led starts flashing from the strongest signal from the instrument.

*Note: A correctly set GAIN is vital for the signal processing to work properly in the Classic 500.*

**DRIVE** - The DRIVE knob controls the amount of gain in the tube emulation stage, and provides an extra gain all the way up to 30 dB. The gain is compensated over this section producing a warm overdrive while the output remains more or less constant. This control also compresses the sound when turning up level up to maximum, producing a pure tube like limitation.

The lower frequencies below 250 Hz are bypassed in the Drive stage, producing a warmer distortion without saturation, allowing the player to add more low bass than with conventional bass amps. The bass is compensated over the tube stage, which gives the same bass response up to mid distorted levels.

**VOLUME** - The VOLUME knob controls all volume in the unit, controlling the power amp and LINE output. The balanced output (XLR) is not effected by the setting of this knob.

**STANDBY** - This switch mutes all outputs and disconnects the speaker outputs. This is suitable for tuning your instrument or when you wish to change speaker connections without powering off the amp.

**POWER** - Powers the unit on or off.

3

**FILTERS** - The filter section contains four enhanced performance filters:

**BASS** is a 'shelving' type 12dB/oct slope phase compensated bass filter with a wide gain range.

**LOW MID** has a frequency range of 150-900Hz. This filter facilitates total control over the lower midrange frequencies, defining the tone and the body of your sound.

**HIGH MID** has frequency range of 1.2-7 kHz. This filter gives you total control over the higher midrange frequencies giving definition and good voicing to you sound.

**TREBLE** is a 'shelving' type filter controlling the higher mids and treble registers, giving presence and ambiance to the sound.

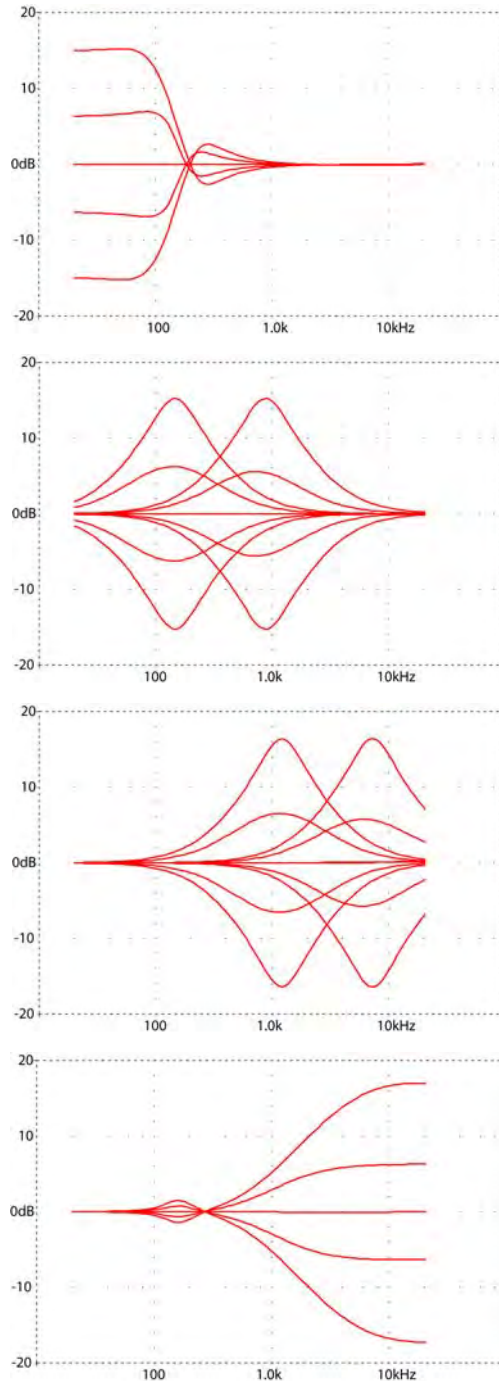

**BALANCED OUTPUT** - Is a high quality balanced output that functions as a line box for connecting to PA mixing consoles or to studio or broadcast recording units.

Lifting ground is a great aid in many occasions. When required, set the *Gnd Lift* switch to inner position to disconnect the ground from the output.

The *Post Eq* switch selects the signal source. In the inner position this switch selects the overall sound from the amp. Otherwise, in the outer position an uncolored sound is taken immediately after the input and gain sections.

**LINE OUT** - This is a fullrange output that will drive multiple poweramps, extending the power of the system.

**SPEAKER OUTPUTS** - The two Speakon® connectors allow you to connect the amp to your favorite cabinets. The connectors are wired in parallel, so it doesn't matter which one to use when only connecting one cabinet.

Minimum permissible speaker load is 2 ohms, which means that you could connect any combination of speakers as below:

- One 4 ohms cabinet.
- Two 4 ohms cabinets.
- One 4 ohms cabinet and two 8 ohms cabinets.
- A total of four 8 ohms cabinets.

Also, higher impedance cabinets work well, such as only one 8 ohms cabinet. The output power will however be lower in this case.

**POWERAMP**- The internal poweramp is of MOSFET design giving natural sound reproduction and high power output with exceptional clarity.

The incorporated soft clip system provides tube-like distortion characteristics, protects the power amp from saturation and increases its output performance and sound quality.

The poweramp makes possible maximum continuous power output, reducing the maximum temperature of the unit by the use of a temperature controlled active cooling system.

**! Note that you may run the Classic 500 without any speaker load. No damage will be done to the amplifier whatsoever.**

**IMPORTANT:** Make sure not to cover the fan or the ventilation holes on the amp.



**EBS will not take responsibility for eventual hearing damages caused by the powerful Classic 500.**