

# aDrums EXS-3

Electronic Drums

EN

CZ

DA

NL

FI

FR

DE

IT

PL

PT

ES

SV

**Quick Start Guide**

# Welcome.

## ■ Contents

Package Contents . . . . .	3
Assembly Guide . . . . .	4
Top Panel . . . . .	10
Rear Panel . . . . .	11
<hr/>	
<b>1 Getting Ready. . . . .</b>	<b>12</b>
Connecting Audio Equipment . . . . .	12
Connecting the Pads . . . . .	12
Zones supported by the xD3's trigger inputs . . . . .	13
Power On / Off . . . . .	13
Turning the power off automatically (auto power-off) . . . . .	13
Trigger settings . . . . .	14
Cross-talk Cancel Wizard . . . . .	15
<hr/>	
<b>2 Performing. . . . .</b>	<b>16</b>
Home Screen . . . . .	16
Performing . . . . .	16
Corresponding styles of playing . . . . .	16
Changing the Drum Kit . . . . .	17
Selecting a drum kit from the list . . . . .	17
<hr/>	
<b>3 Detailed Information. . . . .</b>	<b>18</b>
Details of functions . . . . .	18
Specifications . . . . .	18
Support . . . . .	18
<hr/>	
<b>4 Important Notice . . . . .</b>	<b>19</b>
Important Safety Information. . . . .	19
Important Information about Use . . . . .	20

Before using aDrums EXS-3, be sure to read '4 Important Notices' p.19.

# Setup

## ■ Package Contents

This product includes the following items.



Kick Pad



Spurs for Kick Pad x2



Crash Cymbal Pad



Ride Cymbal Pad



Snare Pad



Tom Pads x3



Hi-hat pad



AC adapter for hi-hat pad

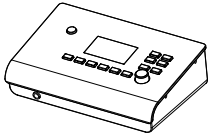

xD3 drum sound instrument



AC adapter

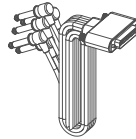

Multi-trigger cable

- Quick Start Guide (this booklet)
- SD memory card
- Cable tie
- Drum key

### Drum Rack



Tube A x2



Tube B x2

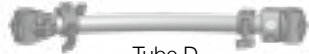

Tube D



Tube E



Tube F



Tube C



Cymbal arms x2



Drum arms x4

## ■ Assembly Guide

Connect tubes A to F as the figure right shows.

\*A corresponding label (A to F) is attached to each tube.

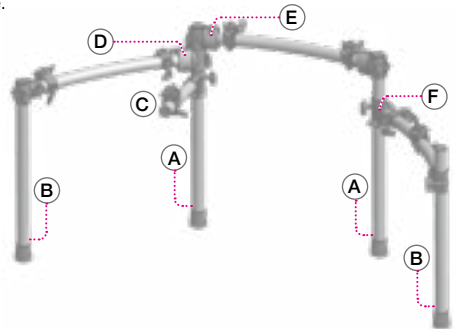

### 1 Insert tube A into the tube C clamp

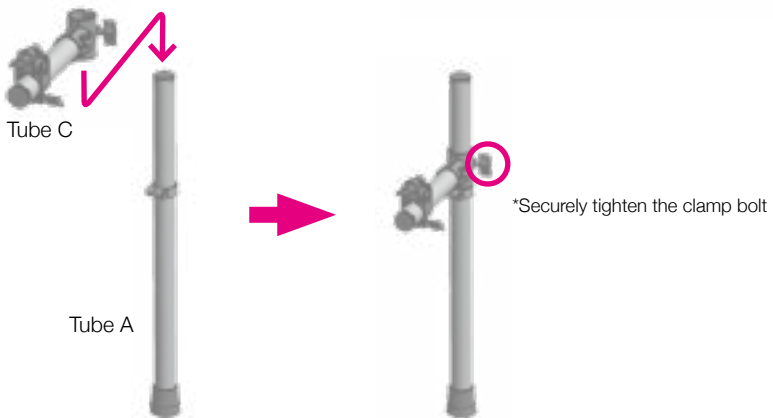

### 2 Insert tube A and tube B into the clamps at the ends of tube D

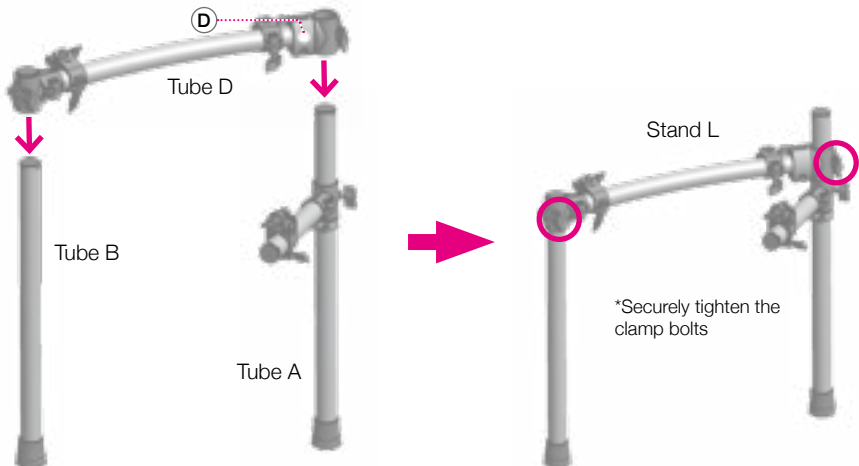

**3** Insert tube A and tube B into the clamps at the ends of tube F

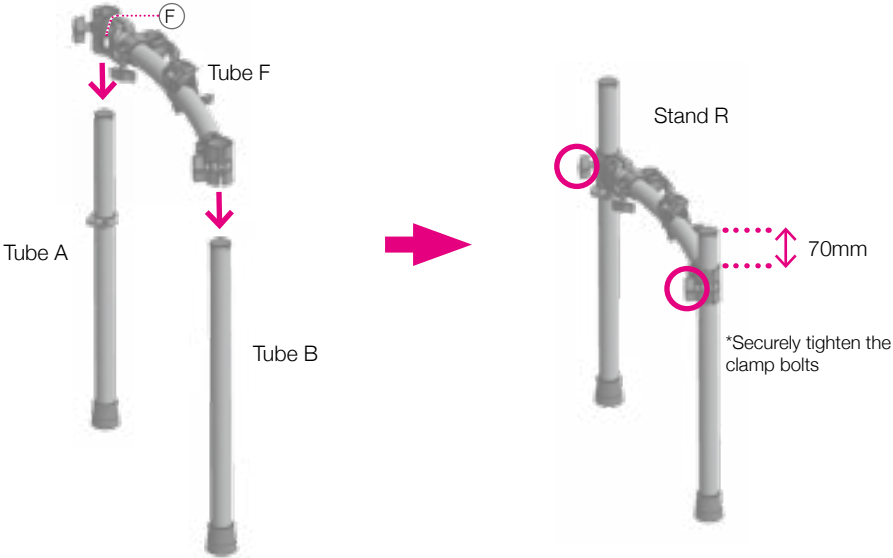

**4** Attach tube E clamps to stands L and R

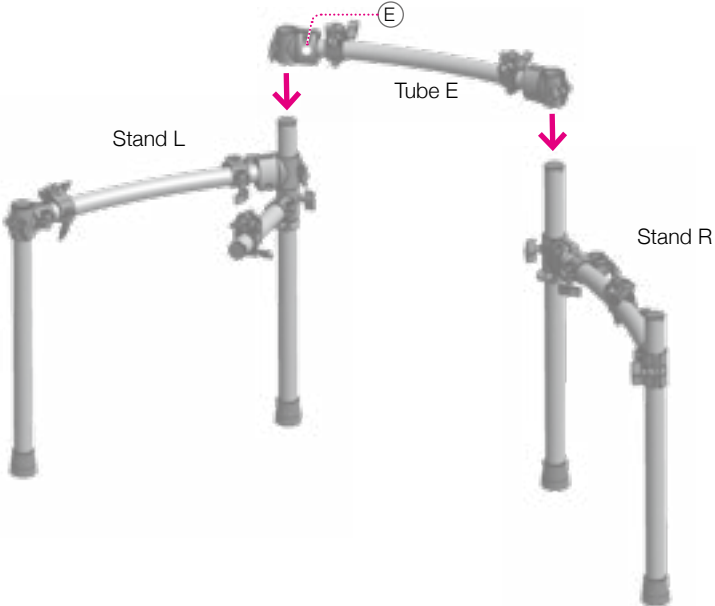

## 5 Attach the cymbal boom arms

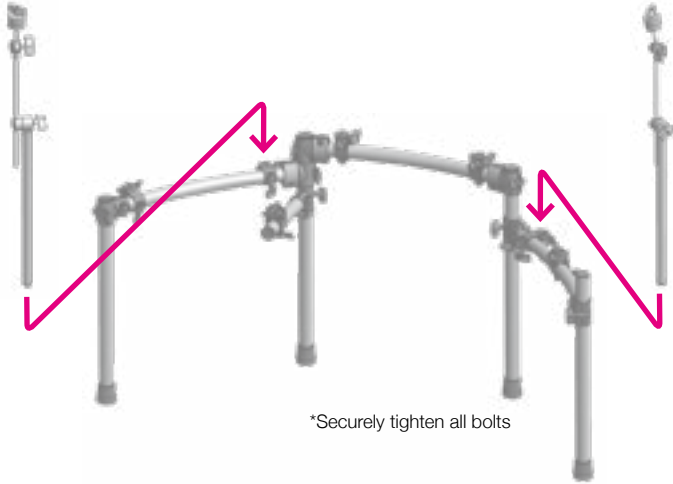

## 6 Attach the L-arm to the clamp (1) and the snare to the L-arm (2)

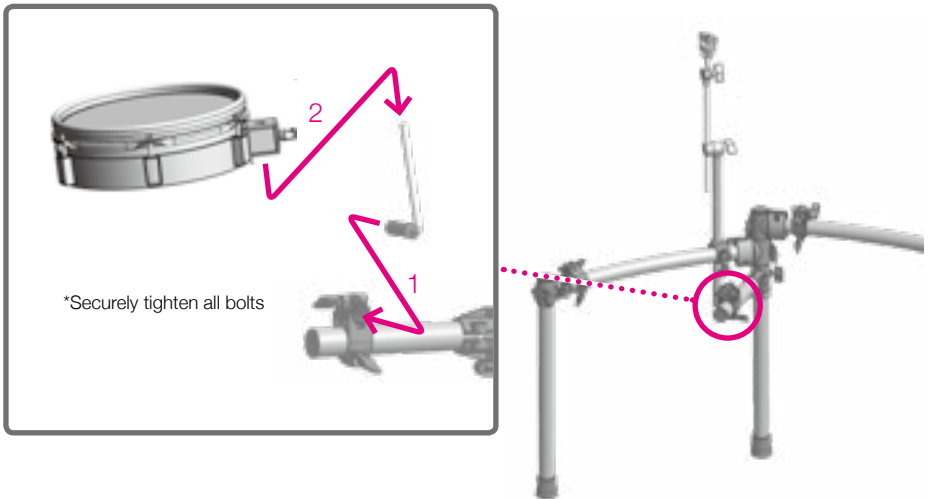

\*Adjust the tension of the pad head using the included tuning key.

**7** Attach the tom L-arms to the clamps (1) and the toms to the L-arms (2) as shown

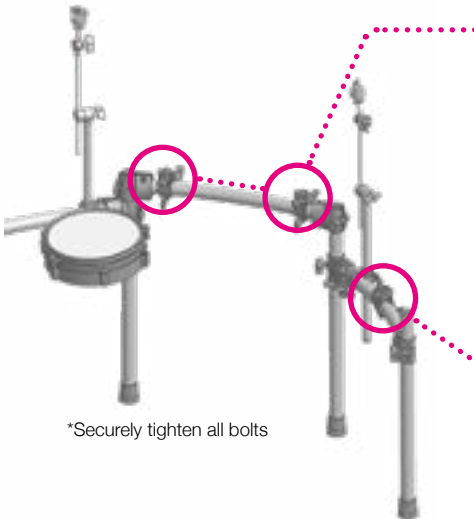

\*Securely tighten all bolts

\*Adjust the tension of the head using the tuning key included in the package.

**8** Attach the cymbal pads to the boom arms.

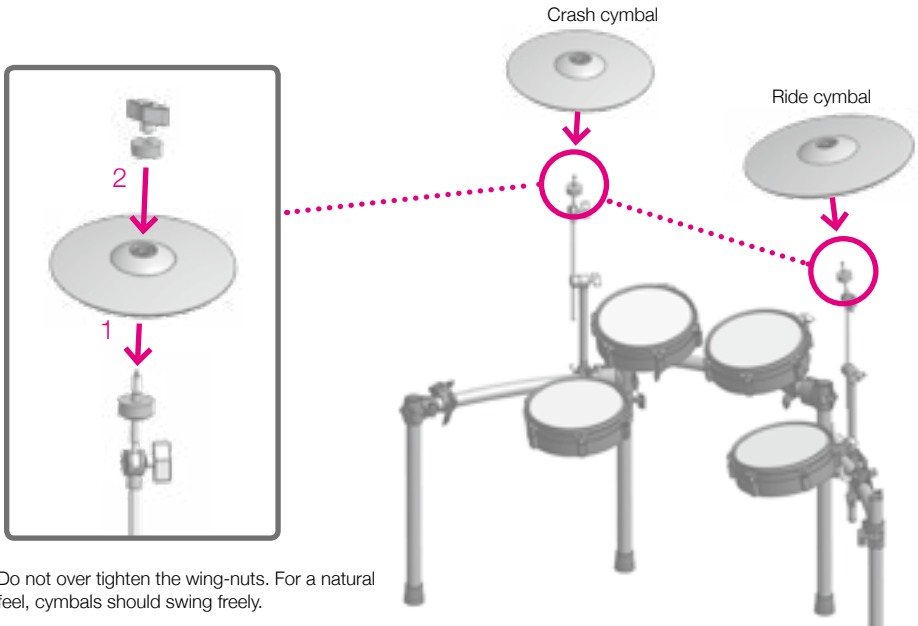

Do not over tighten the wing-nuts. For a natural feel, cymbals should swing freely.

## 9 Attach the hi-hat cymbals

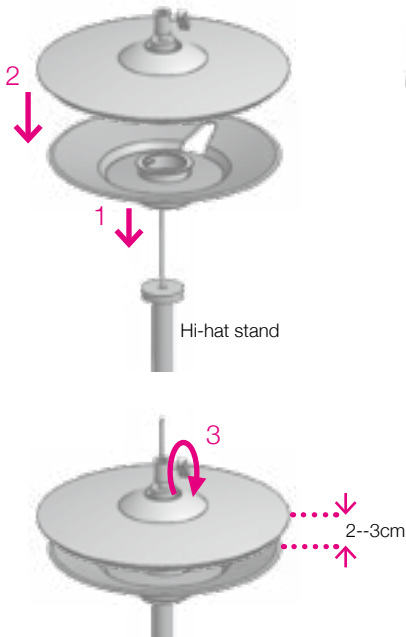

\*A hi-hat stand is not included.

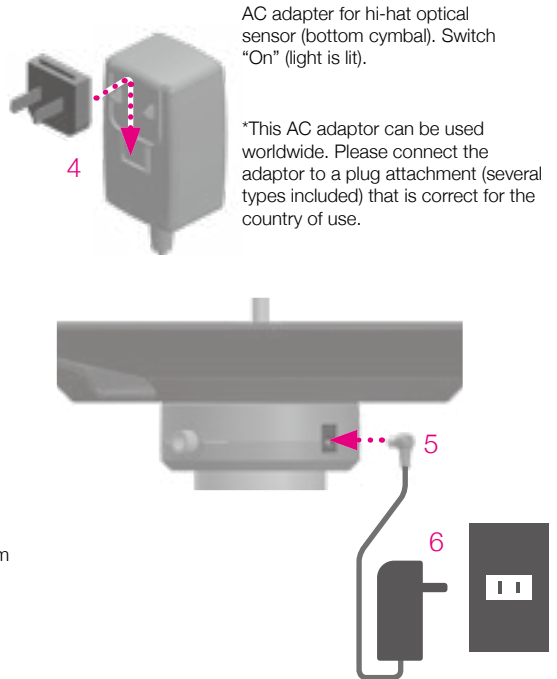

AC adapter for hi-hat optical sensor (bottom cymbal). Switch "On" (light is lit).

\*This AC adaptor can be used worldwide. Please connect the adaptor to a plug attachment (several types included) that is correct for the country of use.

## 10 Attach the spurs to the kick drum pad

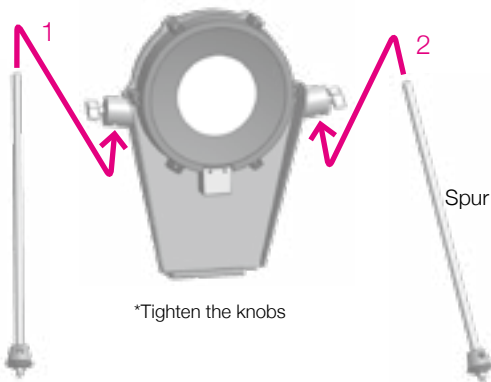

\*A kick pedal is not included.

\*The tip of the spur can be adjusted so it protrudes from the rubber stopper.

\*Note that the spikes can damage floors.

\*Note that the spikes can damage your body.

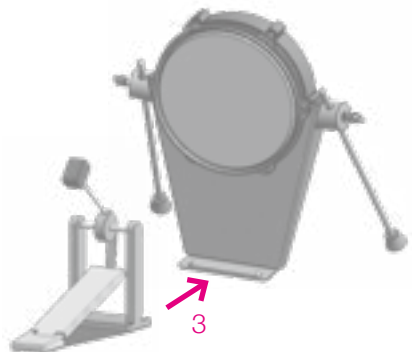



# 11 Attach the xD3 drum sound instrument

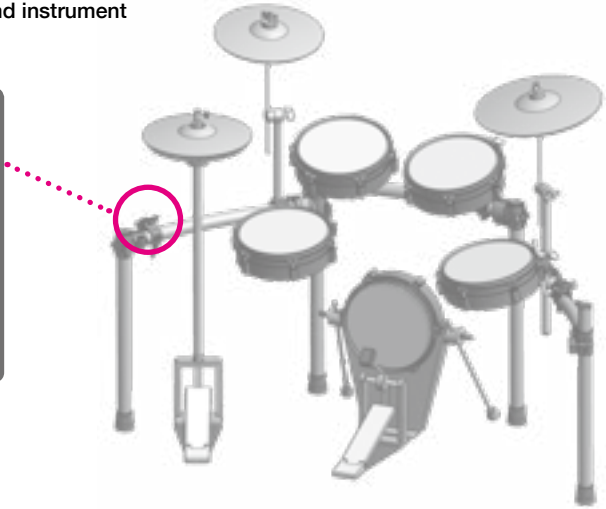
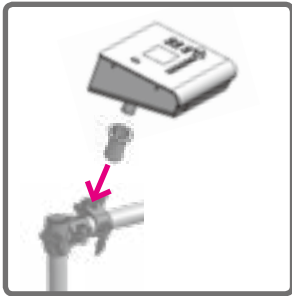

\*After completing the assembly verify that all the bolts are securely tightened.

## ■ xD3 Top Panel

Only the buttons being operated light up.

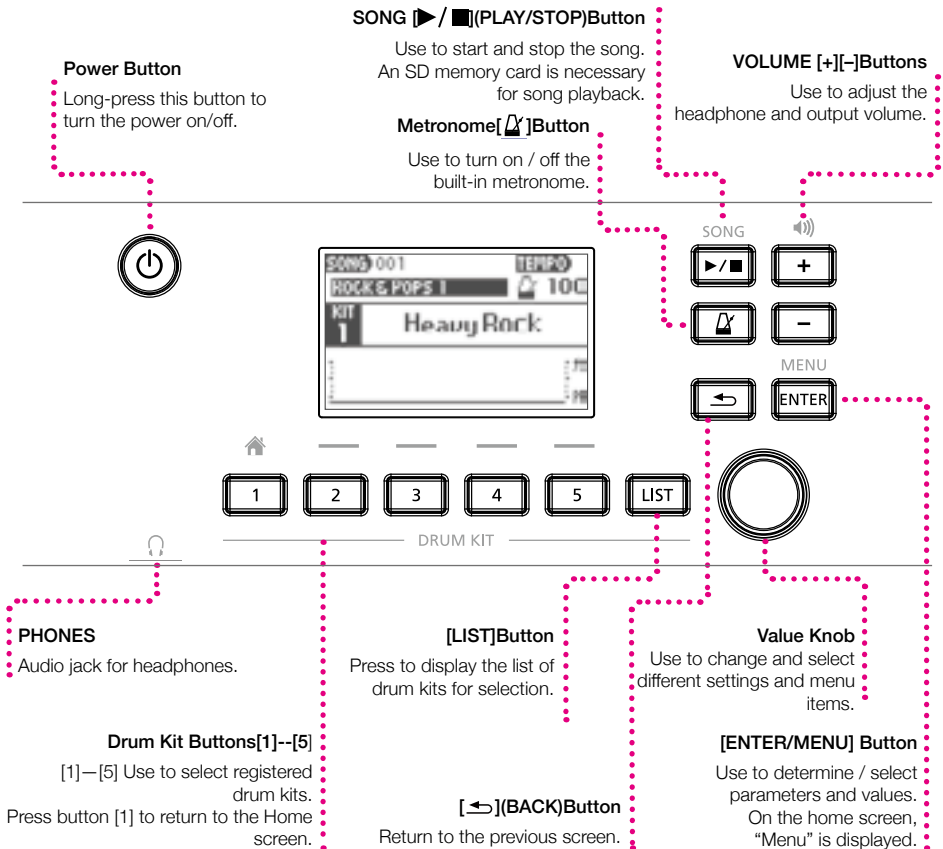

### About the Function Buttons

Aside from the "Home" screen, buttons [2] [3] [4] [5] are used to select displayed menu functions.

For example, as shown on the screen (right):

- [2] Button = DELETE
- [4] Button = HELP
- [5] Button = LOAD

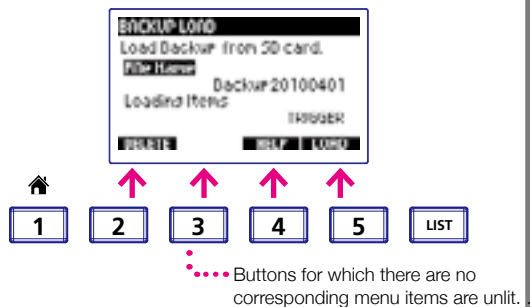

## ■ xD3 Rear Panel

### SD CARD

Insert the included SD card that contains song data. Additional songs can also be stored and loaded. The SD card is also used to back-up and import xD3 sound data. The xD3 is only compatible with SD /SDHC cards from 2 GB up to 32 GB.

### USB

The xD3 can be connected to a Mac or Windows PC, allowing MIDI messages to be transmitted and received. Use a USB 2.0 cable.

### MIDI OUT

Connect MIDI devices and send MIDI signals.

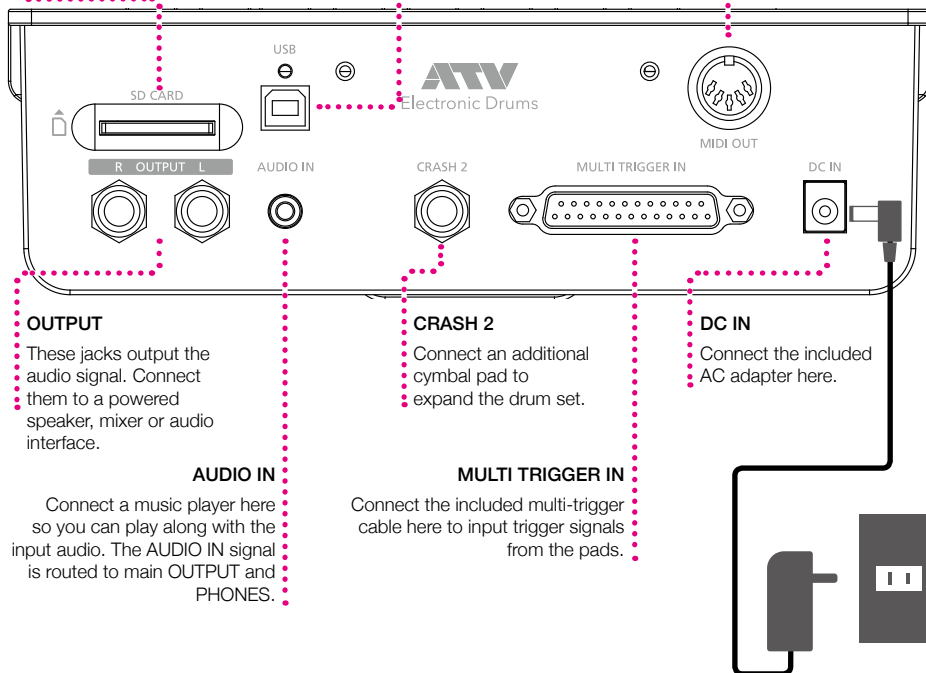

### OUTPUT

These jacks output the audio signal. Connect them to a powered speaker, mixer or audio interface.

### AUDIO IN

Connect a music player here so you can play along with the input audio. The AUDIO IN signal is routed to main OUTPUT and PHONES.

### CRASH 2

Connect an additional cymbal pad to expand the drum set.

### MULTI TRIGGER IN

Connect the included multi-trigger cable here to input trigger signals from the pads.

### DC IN

Connect the included AC adapter here.

### About the AC adapter

The AC adapter can be used worldwide.

Attach the included plug that is suitable for the type of outlet in your country.

\*You must use only the included AC adapter and plug.

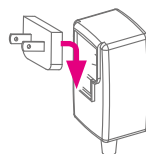

# 1 Getting Ready

## ■ Connecting Audio Equipment

In order to use the xD3, you will need the following items.

- Headphones or powered speakers, etc.

You can play along with your own songs by connecting a music player's stereo line output to the xD3's AUDIO IN jack.

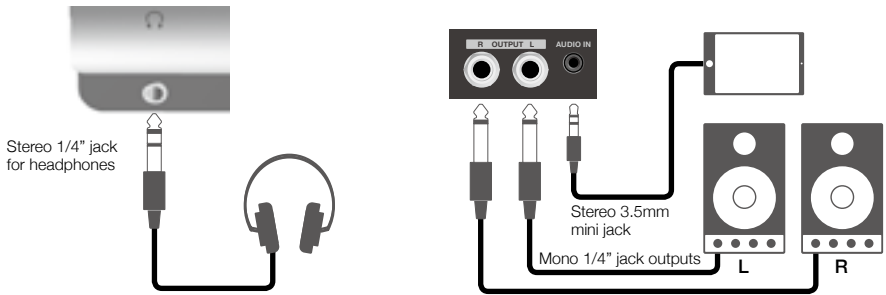

## ■ Connecting the pads

First connect the multi-trigger cable to the xD3's rear panel and then to each pad. Note the connection destination labeled on each jack plug and connect them as shown in the illustration. After completing all connections, fix the cables onto the stands using the included cable ties.

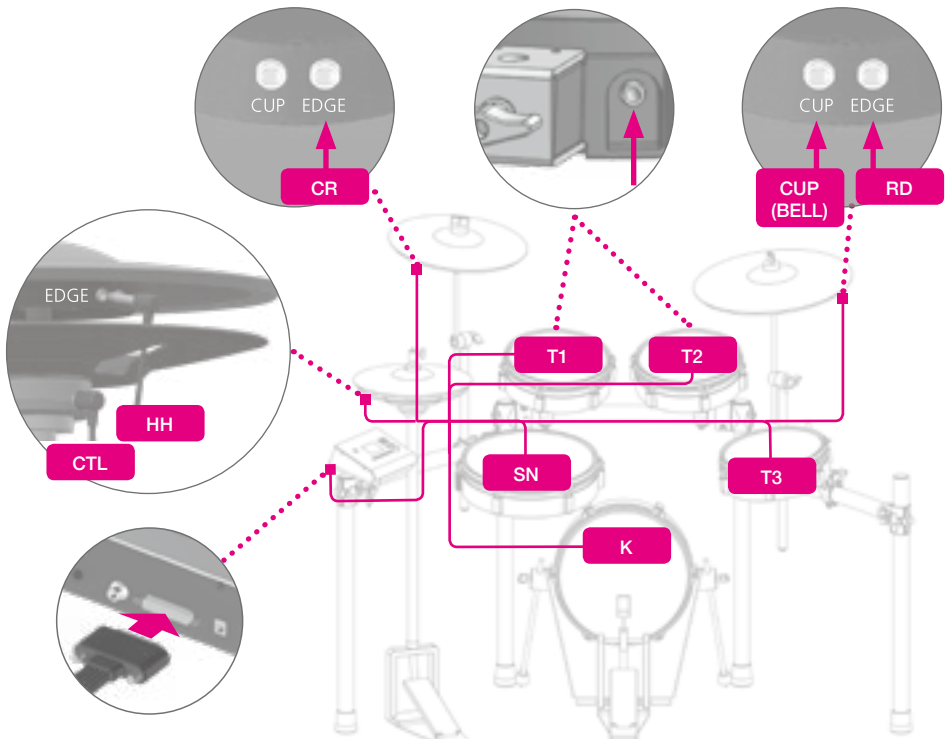

## ■ Zones supported by the xD3's trigger inputs

xD3 trigger input	Supported zone	Choke method	Notes
KICK	Head	N/A	Input hardware is only single-trigger capable.
SNARE	Head,Rim	N/A	Side stick sound function can be enabled, see the user's manual. (Only available on the snare input.)
TOM 1	Head	N/A	Input hardware is only single-trigger capable.
TOM 2	Head	N/A	Input hardware is only single-trigger capable.
TOM 3	Head	N/A	Input hardware is only single-trigger capable.
HI-HAT	Bow,Edge	YES	
CRASH	Bow,Edge	YES	
RIDE	Bow,Edge,Cup	YES	Three-zone input requires two pad cables.
CRASH 2	Bow,Edge	YES	

## ■ Power On / Off

### Turning the power on

**1** Lower the volume of the connected amp or speakers.

**2** Turn on the power of the hi-hat.

The indicator under the hi-hat turns on.

**3** Long-press the power button of the xD3.

The power turns on.

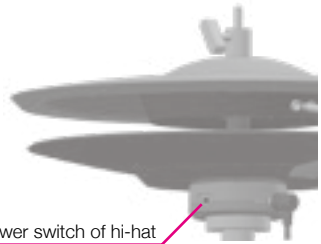

### Turning the power off

**1** Lower the volume of the connected amp or speakers.

**2** Long-press the power button of the xD3.

The power turns off.  
All settings are saved.

\*Disconnecting the AC adapter without turning off the power can cause malfunctions. Always turn off the power by pressing the power button.

**3** Turn off the hi-hat power switch.

### Turning the power off automatically (auto power-off)

If the xD3 has not been played or operated for 30 minutes, it automatically turns off the power in order to conserve electricity. This function can be disabled.

For details, please refer to the User's Manual.

**\*The power of the hi-hat is not automatically turned off.**

## ■ Trigger Settings

These settings are used to optimize the performance of the xD3 by calibrating the unit's triggering sensitivity in response to signals from the pad sensors.

Setting up the sensitivity of triggers is important when using the equipment for the first time or when changing the type of pad.

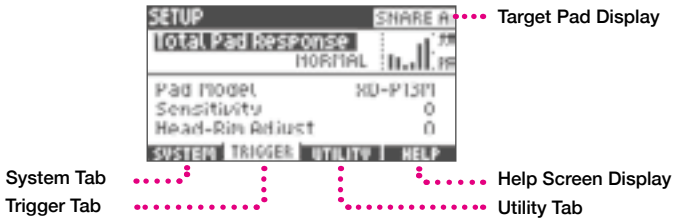

**1** Press the [3] (TRIGGER) button and select the trigger tab.

**2** Use the value knob to select an item and press the [ENTER] button.

\*These general settings are applied to all drum kits.

<b>Total Pad Response</b>	Increasing the sensitivity of all pads will produce a powerful sound even when playing with soft taps. This may be suitable for younger children or players who have a softer playing style. The sensitivity increases as you increase the plus [+] value.
<b>Pad Model</b>	Use to set the type of pad connected to each trigger input. *Please use the default setting.
<b>Sensitivity</b>	Use to adjust the sensitivity of each pad. The sensitivity increases as you increase the value.
<b>Head-Rim Adjust</b>	Use to adjust the balance sensitivity between the head sound and the rim-shot sound of the snare drum pad. If the rim-shot sounds consistently when you hit the snare pad head, try adjusting the slider position more towards the 'H' side to find a balance. If you find it difficult to play the rim-shot, try adjusting the slider more to the 'R' side.
<b>Pedal HH Sens</b>	Use to adjust the volume of the foot-close and foot-splash hi-hat sounds.
<b>HH Close Adjust</b>	Use to adjust the closed position of the hi-hat. If the hi-hat does not sound sufficiently 'closed' when pressing on the pedal with normal pressure, adjust this setting to the plus [+] side. If the hi-hat does not sound sufficiently 'open' when the pedal pressure is relaxed or released, adjust this setting to the minus [-] side.
<b>Cross-Talk Cancel Wizard</b>	Use to eliminate "cross-talk", which is an unwanted signal transmission between pads. Simply hit each pad according to the Cross-talk Cancel Wizard instructions and the appropriate settings will be made automatically. For detailed instructions, please refer to the section about using the "Cross-talk Cancel Wizard" (p.15). *Execute this wizard when installing the drum kit for the first time. *Cross-talk may reoccur if you change a pad or a pad's mount location. *In such cases, please re-execute the wizard.

**3** Use the value knob to change the item and confirm by pressing the [ENTER] button.

## ■ Cross-talk Cancel Wizard



### 1 Press the [5] (NEXT) button.

To cancel, press the [2] (CANCEL) button.

### 2 Follow the instructions on the screen and strike the indicated pad 3 times with powerful hits.

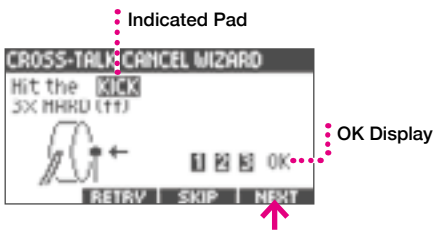

\*If you press [RETRY], the strikes you made so far will be erased and you can start over.

### 3 When "OK" is displayed, press the [5] (NEXT) button to advance to the next step.

### 4 Repeat step 1 and step 2 in the same way.

The xD3 measures the cross-talk condition of all connected pads.

KICK > SNARE > TOM 1 > TOM 2 > TOM 3 > HI-HAT > CRASH 1 > RIDE > CRASH 2

\*If the indicated pad is not connected, press [SKIP].

### 5 When the screen below is displayed, play the drum set and check if there are any remaining cross-talk problems, then press the [5] (OK) button.



\*If you still detect a cross-talk problem, press the [2] (RETRY) button and repeat the wizard again.

\*Cross-talk problems may not be completely prevented in all cases.

## 2 Performing

### ■ Home Screen

The Home screen is displayed after turning on the power.

Press the [1] (HOME) button from any screen to return to the Home Screen.

The Home Screen is displayed when playing the drums.

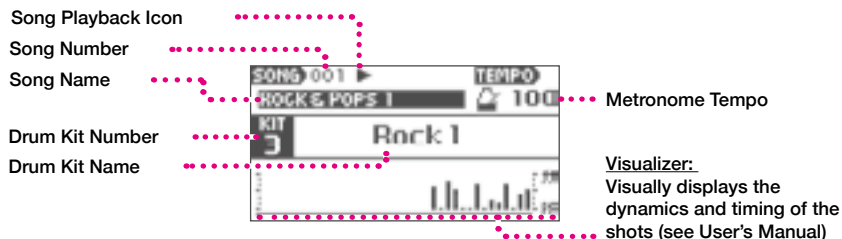

### What is an xD3 Drum Kit?

The xD3 patch that assigns sounds to each pad is called a "drum kit". Changing the drum kit patch to Jazz or Rock changes the sound of each pad to a sound suitable for that genre.

### ■ Performing

#### 1 When you hit the pad, it resounds.

The sound changes naturally according to the strength of the hit.

#### 2 Use VOLUME [+][-] to adjust the volume.

\*Adjust the volume to an appropriate level for natural playing.

If the output volume is too low, it may cause you to exert unnecessary force when playing, which may cause pain and possibly injury to your hands and arms. Please avoid setting the output volume too loud as this may damage your hearing and the hearing of others around you, especially young children.

It is possible to set a maximum volume limit for the xD3 (Refer to User's Manual).

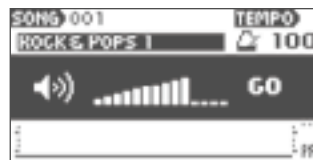

### Corresponding styles of playing

Snare drum	head shot, rim shot, side stick
Hi-hat	bow, edge, open-close, foot close, foot splash
Crash cymbal	bow, edge
Ride cymbal	Bow, edge, cup



## ■ Changing the Drum Kit

- 1 Press one of drum kit buttons [1]–[5].



The drum kit saved for each button is loaded.  
\*It takes several seconds to load the drum kit.

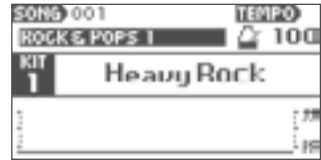

- 2 When the drum kit name is displayed, you can start playing.

## ■ Selecting a drum kit from the list

Use this function to select and load a drum kit other than those already assigned to buttons [1]–[5].

- 1 Press the [LIST] button.

The list of drum kits will be displayed.

- 2 Select the drum kit with the value knob.

- 3 Press the [ENTER] button.

The selected drum kit will be loaded.

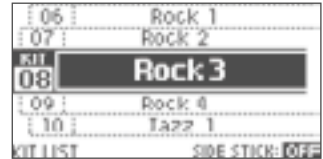

## 3 Detailed Information

### ■ Details of functions

The xD3 has many other functions.

For detailed information and a detailed explanation of the functions, please refer to the User's Manual that you can download from the following URL:

[http://www.atvcorporation.com/en/products/drums/exs-5\\_3/support.html](http://www.atvcorporation.com/en/products/drums/exs-5_3/support.html)

### ■ Specifications

#### Electronic Drum Sound Module

Model: xD3

Item	Specification
Terminals and Jacks	AUDIO OUTPUT: L/R, mono ¼ inch (6.35mm) jack x2 PHONES: stereo ¼ inch phone type AUDIO INPUT: stereo, 3.5mm TRS jack MULTI-TRIGGER INPUT: dedicated multi-connector, 25 PIN D-sub to individual ¼ inch TRS plugs CRASH 2 TRIGGER INPUT: ¼ inch TRS jack USB: 2.0 Type B, for MIDI in/out via USB MIDI OUT: 5-pin DIN SD Card: SD/SDHC card (2-32GB only) DC IN: Only for the included AC adapter
Power supply	DC 12 V
Power consumption	600 mA

\*Specifications and appearance of this product are subject to change without notice for improvement.

### ■ Support

Refer to the following URL for frequently asked questions, firmware updates, and other information:





[http://www.atvcorporation.com/en/products/drums/exs-5\\_3/support.html](http://www.atvcorporation.com/en/products/drums/exs-5_3/support.html)

## 4 Important Notices



### ■ Important safety information









Always follow the basic precautions listed below to avoid the possibility of serious injury from fire, electrical shock or other hazards, and serious damages to the aDrums EXS-3 instrument or other goods and assets. Before using aDrums EXS-3, be sure to read all the safety information below.











#### About the symbols

	"Caution": Calls your attention to a point of caution
	"Do not ...": Indicates a prohibited action
	"You must ...": Indicates a required action

#### About warnings and cautions

 <b>WARNING</b>	Indicates a hazard that could result in death or serious injury
 <b>CAUTION</b>	Indicates a hazard that could result in injury or property damage

 <b>WARNING</b>	
	<b>Do not disassemble or modify</b> Do not disassemble or modify this product.
	<b>Do not use or store in the following locations</b> <ul style="list-style-type: none"> <li>• Locations of high temperature (in direct sunlight, near heating equipment)</li> <li>• Moist or humid locations (near a bath or shower, or on a wet floor)</li> <li>• Locations subject to salt damage</li> <li>• Locations subject to water or rain</li> <li>• Excessively dusty locations</li> </ul>
	<b>Do not damage the power cord</b> Do not excessively bend the power cord or damage it. Do not place heavy objects on top of the power cord. Doing so may damage the power cord, causing fire or electric shock.
	<b>Use the included AC adapter</b> Use only the included AC adapter. Use the adapter with the voltage that it specifies.
	<b>Turn off the power if an abnormality or accident occurs</b> In the following situations, immediately turn off the power, disconnect the AC adapter from the AC outlet, and contact your dealer or ATV for servicing. <ul style="list-style-type: none"> <li>• If the AC adapter, power cord, or plug is damaged</li> <li>• If smoke is emitted or an abnormal odor is noticed</li> <li>• If liquid or a foreign object enters the unit</li> <li>• If an abnormality or malfunction occurs in the unit</li> </ul>
	<b>Do not drop or subject to strong impact</b> Do not drop this product or subject it to strong impact.
	<b>Do not plug or unplug the AC adapter with wet hands</b> You risk electric shock by doing so.

 <b>CAUTION</b>	
	<b>Grasp the power plug when connecting or disconnecting</b> When connecting or disconnecting the AC adapter from the unit, you must grasp the plug rather than pulling the power cord.
	<b>Don't use AC outlet multipliers</b> Doing so will cause the outlet to become hot, causing a fire hazard.
	<b>If the power plug is dusty, wipe it off</b> Dust on the power plug can cause electric shock or short circuits.
	<b>Disconnect the power plug from the AC outlet if not using the unit for an extended time, or if lightning is expected</b> Failure to do so may cause electric shock, fire, or malfunction.
	<b>Disconnect all connections before moving the unit</b> Failure to do so may cause damage to the power cord or cables, or may cause people to trip over the cables.
	<b>Don't place the unit in an unstable location</b> Doing so may cause the unit to overturn, causing personal injury.
	<b>Don't sit or stand on the unit, or place heavy objects on it</b> Doing so may damage the unit. You should also avoid applying excessive force to the buttons, knobs, and input/output jacks. Doing so will cause malfunctions.
	<b>Don't use the unit at high volume for an extended time</b> Using speakers or headphones at high volume for an extended time will damage your hearing.
	<b>Handle the unit with care</b> Take care that your hands or fingers are not injured by corners or openings in the unit.
	<b>Place small parts out of reach of children</b> Place small parts out of reach of children who might accidentally swallow them.

## ■ Important Information about Use

### Installation

- Do not use the instrument in the vicinity of a TV, radio, stereo equipment, mobile phone, or other electric devices. Otherwise, the instrument, TV or radio may generate noise.
- Do not expose the instrument to excessive dust or vibrations, or extreme cold or heat (such as in direct sunlight, near a heater, or in a car during the day) to prevent the possibility of panel dis-figuration, damage to the internal components or unstable operation.
- The sensor of the hi-hat is exposed to extremely strong light, it may cause error.

### Power Supply

- Even when the power switch is turned off, electricity is still flowing to the product at the minimum level. When you are not using the product for a long time, make sure to unplug the power cord from the wall AC outlet.

### Cleaning

- When cleaning the equipment, be sure to use a clean, dry cloth. Cleaning products that contain organic solvents, paint thinner, detergents, and chemically treated cleaning cloths can cause discoloration and/or warping and should not be used.
- Do not dirty the reflection plate of the hi-hat. Otherwise the response of the instrument may get worse. When getting dirty, clean the instrument by using a wet towel.

### Data

- The company can not be held responsible for damage caused by improper use or modifications to the instrument or data that is lost or destroyed.
- The stored contents may be lost due to malfunction of equipment or incorrect operation. Please backup important data.

### About copyrights

- This product incorporates audio / sound data contents in which ATV and third parties own copyrights. Using and copying these materials without permission (except for personal and other uses permitted by the copyright law) is prohibited.
- ATV owns copyrights of the contents embedded or attached to this product. Such copyrighted materials include, without limitation, all computer software, sound / audio files, style / image data files, etc. Any unauthorized use of such programs and contents outside of personal use is not permitted under relevant laws.
- Do not make, resell, redistribute, or republish the abovementioned contents attached or affiliated to the product.

### About this manual

- The illustrations as shown in this manual are for instructional purposes only, and may appear somewhat different from those on your instrument.
- The company names and product names in this manual are the trademarks or registered trademarks of their respective companies.

## For EU countries



- EN This symbol on the product means that used electrical and electronic equipment should not be mixed with general household waste. The correct disposal will help prevent potential negative effects on human health and the environment. For proper treatment, recovery and recycling, please contact your city office, waste disposal services or the shop which you purchased the product.
- DE Dieses Symbol auf dem Produkt bedeutet, dass elektrische und elektronische Altgeräte nicht mit gewöhnlichem Haushaltsabfall vermisch werden sollten. Durch die korrekte Entsorgung werden Umwelt und Menschen vor möglichen negativen Folgen geschützt. Bitte wenden Sie sich bezüglich ordnungsgemäßer Behandlung, Rückgewinnung und Recycling an ihre zuständige Behörde, Ihren Wertstoffhof oder an das Geschäft, in dem Sie das Produkt erworben haben.
- FR Ce symbole sur le produit signifie que les équipements électriques et électroniques usagés ne doivent pas être mélangés avec les déchets ménagers. L'élimination appropriée aidera à prévenir les effets négatifs potentiels sur la santé humaine et l'environnement. Pour un traitement, une récupération et un recyclage appropriés, veuillez contacter votre mairie, le service d'élimination des déchets ou le magasin où vous avez acheté le produit.
- IT Questo simbolo sul prodotto indica che l'apparecchio elettrico ed elettronico usato non deve essere smaltito insieme ai normali rifiuti domestici. Un corretto smaltimento del prodotto contribuisce a prevenire possibili effetti nocivi sulla salute umana e ambientale. Per il trattamento, il recupero e il riciclaggio appropriati, contattate l'ufficio competente locale, il fornitore del servizio di smaltimento rifiuti o il negozio in cui è stato acquistato il prodotto.
- ES Este símbolo en el producto indica que los equipos eléctricos y electrónicos usados no deben mezclarse con la basura doméstica. Su correcta eliminación ayudará a evitar posibles efectos negativos sobre la salud humana y el medio ambiente. Para un tratamiento, recuperación y reciclaje adecuados, póngase en contacto con su ayuntamiento, servicio de eliminación de residuos o el establecimiento donde adquirió el producto.
- PT Este símbolo no produto significa que o equipamento elétrico e eletrónico não deve ser misturado com os resíduos domésticos normais. A eliminação correta ajudará a prevenir possíveis efeitos negativos na saúde humana e no meio ambiente. Contacte as entidades responsáveis locais, o centro de tratamento de resíduos ou a loja onde adquiriu o produto para saber como tratar, recuperar e reciclar resíduos.
- NL Dit pictogram betekent dat gebruikte elektrische en elektronische apparatuur niet samen met huishoudelijk afval kan worden afgevoerd. Deze juiste wijze van afvalverwijdering draagt bij aan de preventie van mogelijke negatieve invloeden op de gezondheid van de mens en het milieu. Neem contact op met uw gemeente of afvalverzamelpunt of de winkel waar u het product hebt gekocht, voor de juiste behandeling, behoud en recycling.
- DA Dette symbol på produktet betyder, at brugt elektrisk og elektronisk udstyr ikke må blandes med almindeligt husholdningsaffald. Den korrekte bortskaffelse vil hjælpe med at forhindre potentielle negative virkninger på menneskers sundhed og miljøet. For korrekt behandling, indsamling og genbrug skal du kontakte dit lokale kommunekontor, affaldsstation eller butikken, hvor du købte produktet.

**ATV EUROPE LDA.**

Rua 28 de Janeiro, nr. 350 – Fração CC-11, Centro Empresarial Candal Park  
Santa Marinha, 4400-335 Vila Nova de Gaia, PORTUGAL

**ATV Corporation**

888-340 Nakagawa, Hosoe-cho, Kita-ku, Hamamatsu, Shizuoka 431-1304, JAPAN

[www.atvcorporation.com](http://www.atvcorporation.com)